

Alienware m16 R2

Owner's Manual

Notes, cautions, and warnings

 **NOTE:** A NOTE indicates important information that helps you make better use of your product.

 **CAUTION:** A CAUTION indicates either potential damage to hardware or loss of data and tells you how to avoid the problem.

 **WARNING:** A WARNING indicates a potential for property damage, personal injury, or death.

Chapter 1: Views of Alienware m16 R2.....	7
Right.....	7
Left.....	7
Front.....	8
Back.....	9
Top.....	10
Bottom.....	11
Service Tag.....	11
Battery charge and status light	12
Chapter 2: Set up your Alienware m16 R2.....	13
Chapter 3: Specifications of Alienware m16 R2.....	14
Dimensions and weight.....	14
Processor.....	14
Chipset.....	15
Operating system.....	15
Memory.....	16
External ports.....	16
Internal slots.....	17
Ethernet.....	17
Wireless module.....	17
Audio.....	18
Storage.....	18
Media-card reader.....	18
Keyboard.....	19
Keyboard shortcuts.....	19
Camera.....	21
Touchpad.....	21
Power adapter.....	22
Battery.....	23
GPU—Integrated.....	23
GPU—Discrete.....	24
External display support.....	24
Display.....	24
Operating and storage environment.....	25
Dell support policy.....	26
Dell low blue light display.....	26
Chapter 4: Alienware Command Center.....	27
Chapter 5: Working inside your computer.....	28
Safety instructions.....	28
Before working inside your computer.....	28

Safety precautions.....	29
Electrostatic discharge—ESD protection.....	29
ESD Field Service kit	30
Transporting sensitive components.....	31
After working inside your computer.....	31
BitLocker.....	31
Recommended tools.....	31
Screw list.....	32
Major components of Alienware m16 R2.....	33

Chapter 6: Removing and installing Customer Replaceable Units (CRUs)..... 36

Base cover.....	36
Removing the base cover.....	36
Installing the base cover.....	38
Memory module.....	40
Removing the memory.....	40
Installing the memory.....	42
Solid-state drive.....	43
Removing the solid-state drive.....	43
Installing the solid-state drive.....	44
Wireless card.....	45
Removing the wireless card.....	45
Installing the wireless card.....	46

Chapter 7: Removing and installing Field Replaceable Units (FRUs)..... 48

Battery.....	48
Rechargeable Li-ion battery precautions.....	48
Removing the battery.....	48
Installing the battery.....	49
Battery cable.....	50
Removing the battery cable.....	50
Installing the battery cable.....	51
Rear I/O cover.....	52
Removing the rear I/O cover.....	52
Installing the rear I/O cover.....	53
Fan and heat-sink assembly.....	55
Removing the fan and heat-sink assembly.....	55
Installing the fan and heat-sink assembly.....	56
Speakers.....	58
Removing the speakers.....	58
Installing the speakers.....	58
Power-adaptor port.....	59
Removing the power-adaptor port.....	59
Installing the power-adaptor port.....	60
Touchpad.....	62
Removing the touchpad.....	62
Installing the touchpad.....	63
Keyboard-controller board.....	65
Removing the keyboard-controller board.....	65

Installing the keyboard-controller board.....	66
Display-hinge covers.....	67
Removing the display-hinge covers.....	67
Installing the display-hinge covers.....	68
Display assembly.....	69
Removing the display assembly.....	69
Installing the display assembly.....	71
Type-C bracket.....	73
Removing the Type-C bracket.....	73
Installing the Type-C bracket.....	74
System board.....	75
Removing the system board	75
Installing the system board	78
I/O board.....	82
Removing the I/O board.....	82
Installing the I/O board.....	83
Audio board.....	84
Removing the audio board.....	84
Installing the audio board.....	85
Power button.....	86
Removing the power button.....	86
Installing the power button.....	87
Palm rest and keyboard assembly.....	88
Removing the palm rest and keyboard assembly.....	88
Installing the palm rest and keyboard assembly.....	89
Chapter 8: Software.....	91
Operating system.....	91
Drivers and downloads.....	91
Chapter 9: BIOS Setup.....	92
Entering BIOS setup program.....	92
Navigation keys.....	92
F12 One Time Boot menu.....	92
System setup options.....	93
Updating the BIOS.....	107
Updating the BIOS in Windows.....	107
Updating the BIOS using the USB drive in Windows.....	107
Updating the BIOS from the F12 One Time Boot menu.....	108
System and setup password.....	108
Assigning a System Setup password.....	109
Deleting or changing an existing system setup password.....	109
Clearing BIOS (System Setup) and System passwords.....	110
Chapter 10: Troubleshooting.....	111
Handling swollen rechargeable Li-ion batteries.....	111
Locate the Service Tag or Express Service Code of your Dell computer	111
Built-in self-test (BIST).....	112
M-BIST.....	112

LCD Power rail test (L-BIST).....	112
LCD Built-in Self-Test (BIST).....	113
System-diagnostic lights.....	113
SupportAssist diagnostics.....	114
Recovering the operating system.....	114
Backup media and recovery options.....	115
Wi-Fi power cycle.....	115
Drain residual flea power (perform hard reset).....	115
Chapter 11: Getting help and contacting Alienware.....	117

Views of Alienware m16 R2

Right

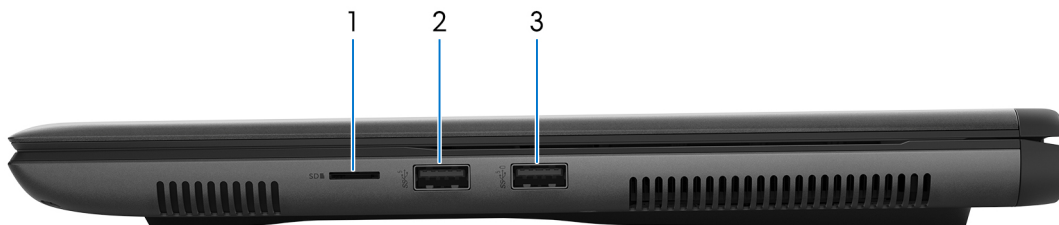

Figure 1. Right view

1. **microSD-card slot**

Read from and write to the microSD card.

2. **USB 3.2 Gen 1 port**

Connect devices such as external storage devices, printers, and external displays. Provides data transfer speeds up to 10 Gbps.

3. **USB 3.2 Gen 1 port with PowerShare**

Connect devices such as external storage devices and printers.

Provides data transfer speeds up to 5 Gbps. PowerShare enables you to charge your USB devices even when your computer is turned off.

NOTE: If your computer is turned off or in a hibernating state, you must connect the power adapter to charge your devices using the PowerShare port. You must enable this feature in the BIOS setup program.

NOTE: Certain USB devices may not charge when the computer is turned off or in a sleep state. In such cases, turn on the computer to charge the device.

Left

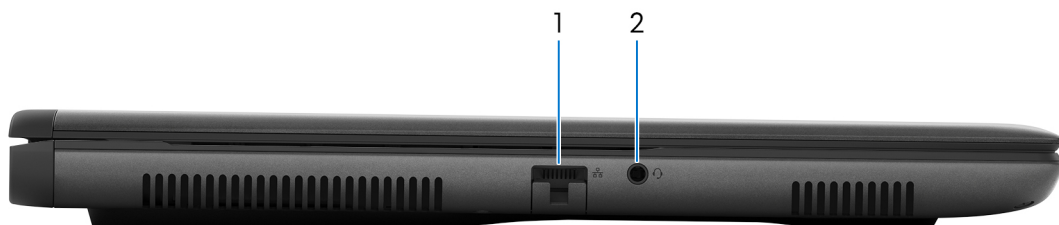

Figure 2. Left view

1. **Network port**

Connect an Ethernet (RJ45) cable from a router or a broadband modem for network or Internet access.

2. **Universal audio jack**

Connect headphones or a headset (headphone and microphone combo).

Front

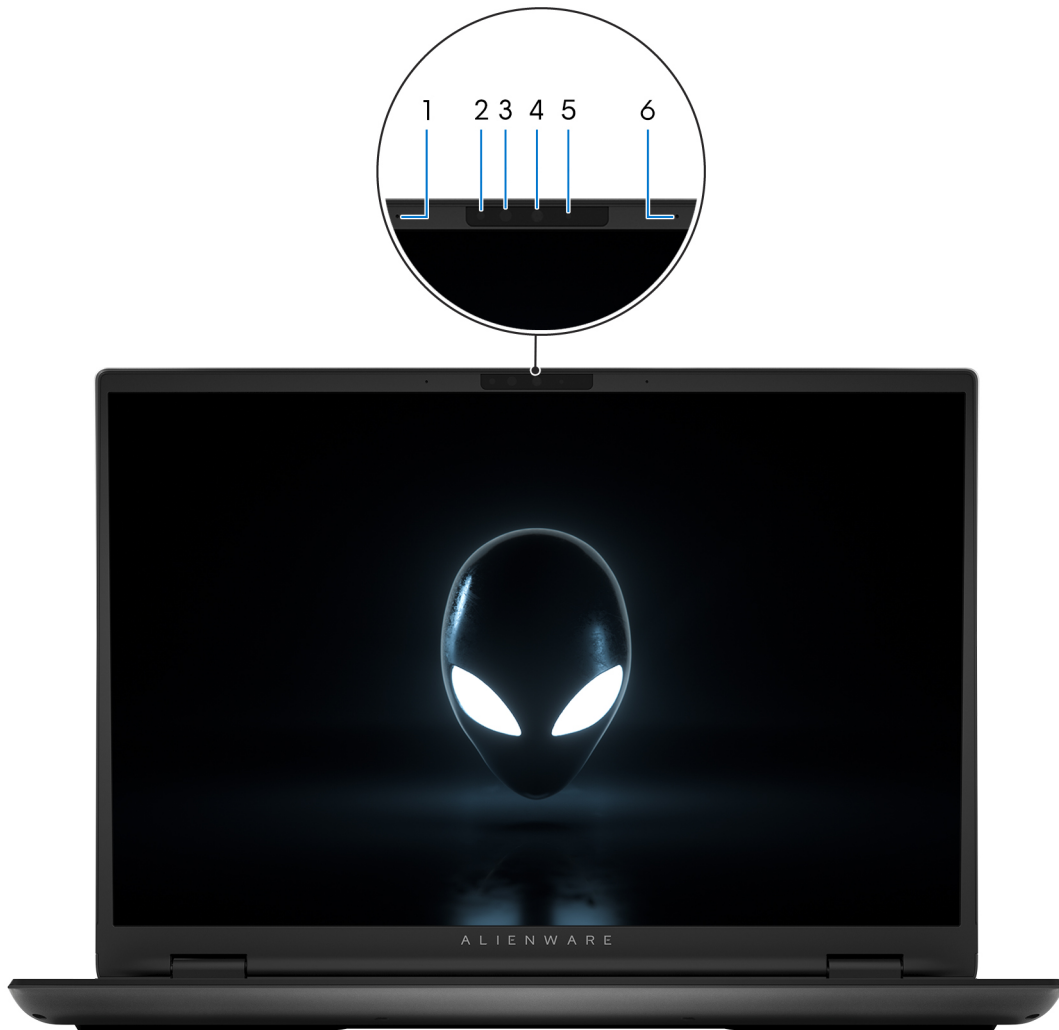

Figure 3. Front view

1. Left microphone

Provides digital sound input for audio recording and voice calls.

2. Infrared emitter

Emit infrared light, which enables the infrared camera to sense and track motion.

3. Infrared camera

Enhances security when paired with Windows Hello face authentication.

4. Camera

Enables you to video chat, capture photos, and record videos.

5. Camera-status light

Turns on when the camera is in use.

6. Right microphone

Provides digital sound input for audio recording and voice calls.

Back



Figure 4. Back view

1. Thunderbolt 4.0 port with Power Delivery

Provides data transfer rates of up to 40 Gbps for USB4 and Thunderbolt 4. Supports USB4, DisplayPort 1.4, Thunderbolt 4, and also enables you to connect to an external display using a display adapter.

NOTE: A USB Type-C to DisplayPort adapter (sold separately) is required to connect a DisplayPort device.

NOTE: You can connect a Dell Docking Station to the Thunderbolt 4 ports. For more information, search in the Knowledge Base Resource at the [Dell Support Site](#).

NOTE: USB4 is backward compatible with USB 3.2, USB 2.0, and Thunderbolt 3.

NOTE: Thunderbolt 4 supports two 4K displays or one 8K display.

2. USB 3.2 Gen 2 (Type-C) port with DisplayPort

Connect devices such as external storage devices, printers, and external displays. Provides data transfer rate of up to 10 Gbps.

Supports DisplayPort 1.4 and also enables you to connect an external display using a display adapter.

NOTE: A USB Type-C to DisplayPort adapter (sold separately) is required to connect a DisplayPort device.

3. HDMI 2.1 port

Connect to a TV, external display, or another HDMI-in enabled device. Provides video and audio output.

4. Power-adapter port

Connect a power adapter to provide power to your computer.

Top

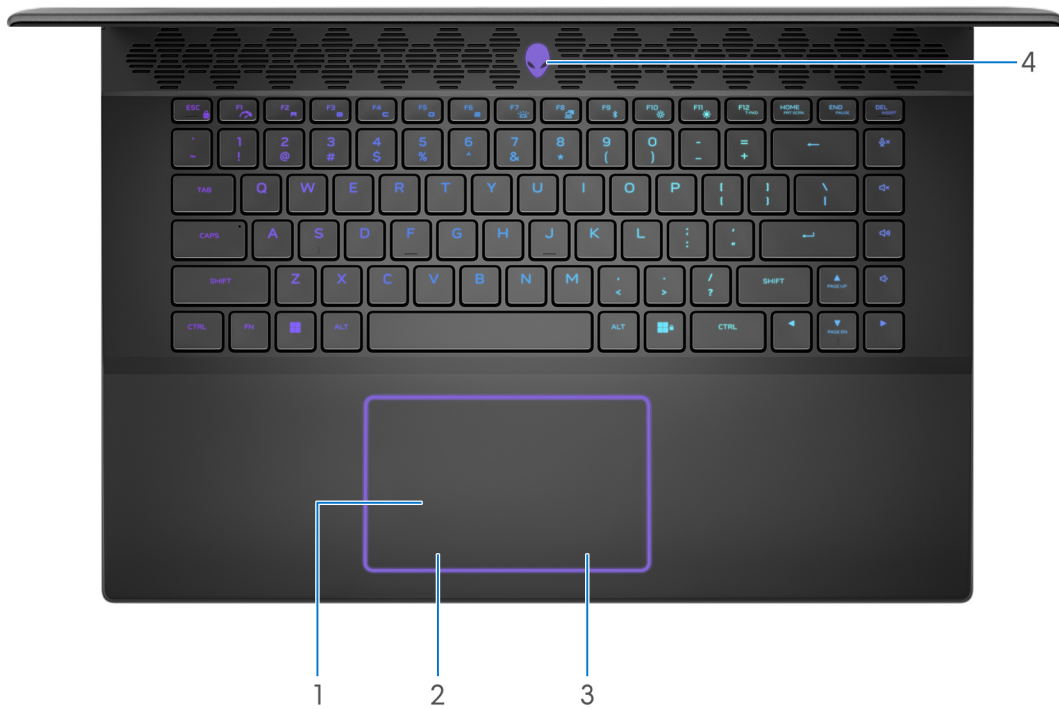

Figure 5. Top view

1. Touchpad

Move your finger on the touchpad to move the mouse pointer. Tap to left-click and two fingers tap to right-click.

2. Left-click area

Press to left-click.

3. Right-click area

Press to right-click.

4. Power button (Alien head)

Press to turn on the computer if it is turned off, in sleep state, or in hibernate state.

Press to put the computer in sleep state if it is turned on.

Press and hold for two seconds to force shut-down the computer.

i **NOTE:** You can customize the power-button behavior in Windows.

Bottom

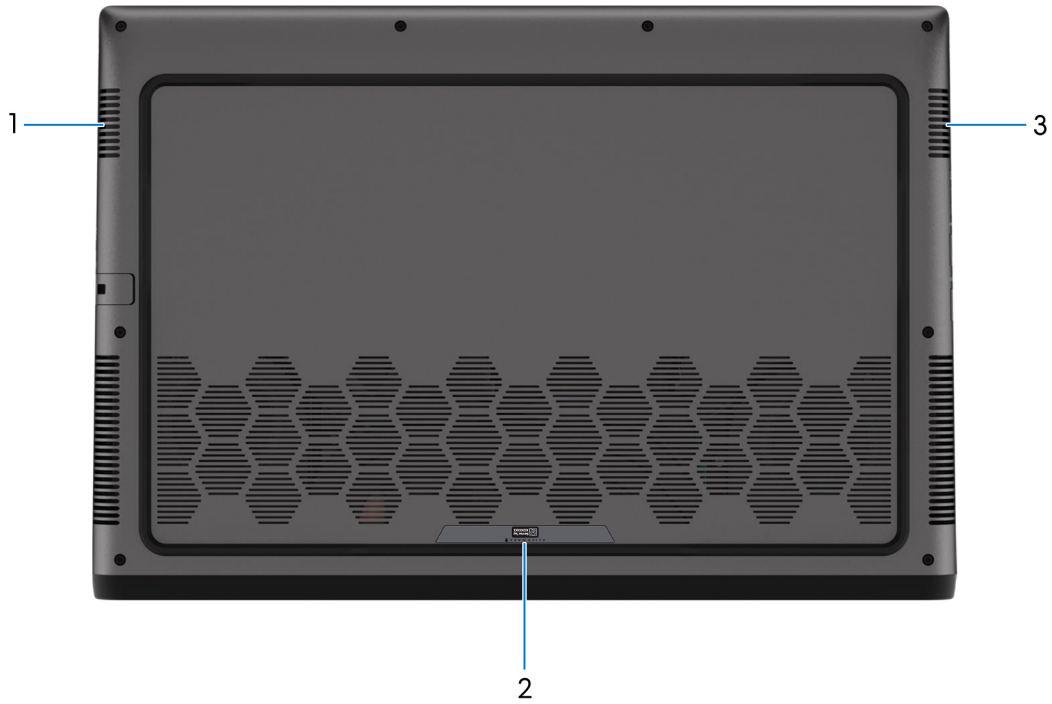

Figure 6. Bottom view

1. Left speaker

Provides audio output.

2. Service Tag label

The Service Tag is a unique alphanumeric identifier that enables Dell service technicians to identify the hardware components in your computer and access warranty information.

3. Right speaker

Provides audio output.

Service Tag

The service tag is a unique alphanumeric identifier that allows Dell service technicians to identify the hardware components in your computer and access warranty information.

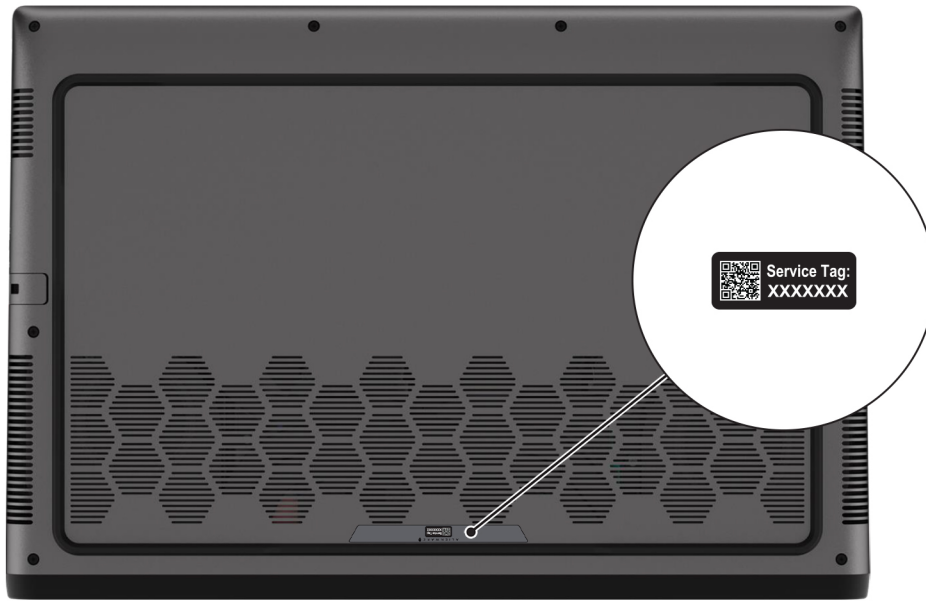

Figure 7. Service tag location

Battery charge and status light

The following table lists the battery charge and status light behavior of your Alienware m16 R2.

Table 1. Battery charge and status light behavior

Power Source	LED Behavior	System Power State	Battery Charge Level
AC Adapter	Off	S0 - S5	Fully Charged
AC Adapter	Solid White	S0 - S5	< Fully Charged
Battery	Off	S0 - S5	11-100%
Battery	Solid Amber (590+/-3 nm)	S0 - S5	< 10%

- S0 (ON) - System is turned on.
- S4 (Hibernate) - The system consumes the least power compared to all other sleep states. The system is almost at an OFF state, except for a trickle power. The context data is written to a hard drive.
- S5 (OFF) - The system is in a shutdown state.

Set up your Alienware m16 R2

About this task

NOTE: The images in this document may differ from your computer depending on the configuration you ordered.

Steps

Connect the power adapter and press the power button.



Figure 8. Set up your Alienware m16 R2

Specifications of Alienware m16 R2

Dimensions and weight

The following table lists the height, width, depth, and weight of your Alienware m16 R2.

Table 2. Dimensions and weight

Description	Values
Height:	
Front height	19.99 mm (0.79 in.)
Rear height	23.50 mm (0.93 in.)
Width	363.90 mm (14.33 in.)
Depth	249.90 mm (9.81 in.)
Weight  NOTE: The weight of your computer depends on the configuration that is ordered and manufacturing variability.	2.60 kg (5.73 lb)

Processor

The following table lists the details of the processors that are supported for your Alienware m16 R2.

Table 3. Processor

Description	Option one	Option two
Processor type	Intel Core Ultra 7 processor 155H	Intel Core Ultra 9 processor 185H
Processor wattage	45	45
Processor total core count	16	16
Performance-cores	6	6
Efficient-cores	8	8
Processor total thread counts	22	22
 NOTE: Intel Hyper-Threading Technology is only available on Performance-cores.		
Processor speed	Up to 4.80 GHz	Up to 5.10 GHz
Performance-cores frequency		
Processor base frequency	1.40 GHz	2.30 GHz
Maximum turbo frequency	4.80 GHz	5.10 GHz
Efficient-cores frequency		
Processor base frequency	0.90 GHz	1.80 GHz
Maximum turbo frequency	3.80GHz	3.80 GHz
Processor cache	24 MB	24 MB
Integrated graphics	Intel Arc Graphics	Intel Arc Graphics

Chipset

The following table lists the details of the chipset that is supported for your Alienware m16 R2.

Table 4. Chipset

Description	Values
Chipset	Integrated with the processor
Processor	Intel Core Ultra 7 processor 155H
DRAM bus width	128-bit (per 64-bit channel)
Flash EPROM	64 MB
PCIe bus	Up to Gen 5.0

Operating system

Your Alienware m16 R2 supports the following operating systems:

- Windows 11 Home (64-bit)

- Windows 11 Professional (64-bit)

Memory

The following table lists the memory specifications of your Alienware m16 R2.

Table 5. Memory specifications

Description	Values
Memory slots	Two-SODIMM slots
Memory type	DDR5
Memory speed	5600 MT/s  NOTE: The memory configuration varies depending on the country or region the computer is purchased in.
Maximum memory configuration	64 GB
Minimum memory configuration	8 GB
Memory size per slot	8 GB, 16 GB, 32 GB, and 64 GB
Memory configurations supported	<ul style="list-style-type: none"> • 8 GB, 1 x 8 GB, DDR5, 5600 MT/s • 16 GB, 1 x 16 GB, DDR5, 5600 MT/s • 16 GB, 2 x 8 GB, DDR5, 5600 MT/s, dual-channel • 32 GB, 1 x 32 GB, DDR5, 5600 MT/s • 32 GB, 2 x 16 GB, DDR5, 5600 MT/s, dual-channel • 64 GB, 2 x 32 GB, DDR5, 5600 MT/s, dual-channel

External ports

The following table lists the external ports of your Alienware m16 R2.

Table 6. External ports

Description	Values
Network port	One RJ45 port
USB ports	<ul style="list-style-type: none"> • One USB 3.2 Gen 1 port • One USB 3.2 Gen 1 port with PowerShare • One USB 3.2 Gen 2 (Type-C) port with DisplayPort • One Thunderbolt 4 port with 15 W Power Delivery (3A/5V capabilities)
Audio port	One universal audio jack (RCA, 3.5 mm)
Video port	One HDMI 2.1 port
Media-card reader	One microSD-card slot
Power-adaptor port	One 7.40 mm x 5.10 mm DC-in
Security-cable slot	Not supported

Internal slots

The following table lists the internal slots of your Alienware m16 R2.

Table 7. Internal slots

Description	Values
M.2	Two M.2 2280 solid-state drive slots  NOTE: To learn more about the features of different types of M.2 cards, search in the Knowledge Base Resource at Dell Support Site .

Ethernet

The following table lists the wired Ethernet Local Area Network (LAN) specifications of your Alienware m16 R2.

Table 8. Ethernet specifications

Description	Values
Model number	Killer E3100 integrated Ethernet controller
Transfer rate	2500 Mbps for Killer E3100 Ethernet controller

Wireless module

The following table lists the Wireless Local Area Network (WLAN) modules that are supported on your Alienware m16 R2.

Table 9. Wireless module specifications

Description	Option one	Option two
Model number	Intel Killer AX1675x	Intel BE202
Transfer rate	Up to 2400 Mbps	Up to 2400 Mbps
Frequency bands supported	2.4 GHz/ 5 GHz/ 6 GHz	2.4 GHz/ 5 GHz/ 6 GHz
Wireless standards	<ul style="list-style-type: none"> ● Wi-Fi 802.11a/b/g ● Wi-Fi 4 (WiFi 802.11n) ● Wi-Fi 5 (WiFi 802.11ac) ● Wi-Fi 6E (WiFi 802.11ax) 	<ul style="list-style-type: none"> ● Wi-Fi 802.11a/b/g ● Wi-Fi 4 (WiFi 802.11n) ● Wi-Fi 5 (WiFi 802.11ac) ● Wi-Fi 6E (WiFi 802.11ax)
Encryption	<ul style="list-style-type: none"> ● 64-bit/128-bit WEP ● AES-CCMP ● TKIP 	<ul style="list-style-type: none"> ● 64-bit/128-bit WEP ● AES-CCMP ● TKIP
Bluetooth wireless card	Bluetooth 5.3 wireless card	Bluetooth 5.4 wireless card
	 NOTE: The version of the Bluetooth wireless card may vary depending on the operating system that is installed on your computer.	

Audio

The following table lists the audio specifications of your Alienware m16 R2.

Table 10. Audio specifications

Description		Values
Audio controller		Realtek ALC3254
Stereo conversion		Supported
Internal audio interface		High-definition audio interface
External audio interface		<ul style="list-style-type: none"> One universal audio jack (RCA, 3.5 mm) One HDMI 2.1 port
Number of speakers		Two
Internal-speaker amplifier		Supported
External volume controls		Keyboard shortcut controls
Speaker output:		
	Average speaker output	2 W + 2 W = 4 W
	Peak speaker output	2.5 W + 2.5 W = 5 W
Subwoofer output		Not supported
Microphone		Digital-array microphones in camera assembly

Storage

This section lists the storage options on your Alienware m16 R2.

Your Alienware m16 R2 supports two M.2 2230/2280 solid-state drive slots.

NOTE: The primary drive of your Alienware m16 R2 varies with the storage configuration. The primary drive of your computer is the M.2 2230/2280 drive where the operating system is installed.

Table 11. Storage specifications

Storage type	Interface type	Capacity
M.2 2280 solid-state drive	PCIe Gen 4 x4 NVMe, up to 64 Gbps	Up to 4 TB per slot
M.2 2230 solid-state drive	PCIe Gen 4 x4 NVMe, up to 64 Gbps	Up to 1 TB per slot

Media-card reader

The following table lists the media cards that are supported on your Alienware m16 R2.

Table 12. Media-card reader specifications

Description	Values
Media-card type	One microSD-card slot

Table 12. Media-card reader specifications (continued)

Description	Values
Media-cards supported	<ul style="list-style-type: none"> • Micro Secure Digital (microSD) • Micro Secure Digital High Capacity (microSDHC) • Secure Digital Extended Capacity (microSDXC)
<p>NOTE: The maximum capacity supported by the media-card reader varies depending on the standard of the media card that is installed on your computer.</p>	

Keyboard

The following table lists the keyboard specifications of your Alienware m16 R2.

Table 13. Keyboard specifications

Description	Values
Keyboard type	<ul style="list-style-type: none"> • 1-zone RGB backlit keyboard • RGB backlit, per key
Keyboard layout	QWERTY
Number of keys	<ul style="list-style-type: none"> • United States and Canada: 85 keys • United Kingdom: 86 keys • Japan: 89 keys
Keyboard size	<p>X=19.05 mm key pitch</p> <p>Y=19.05 mm key pitch</p>
Keyboard shortcuts	<p>Some keys on your keyboard have two symbols on them. These keys can be used to type alternate characters or to perform secondary functions. To type the alternate character, press Shift and the desired key. To perform secondary functions, press Fn and the desired key.</p> <p>NOTE: You can define the primary behavior of the function keys (F1–F12) changing Function Key Behavior in BIOS setup program.</p> <p>For more information, see Keyboard shortcuts.</p>

Keyboard shortcuts

NOTE: Keyboard characters may differ depending on the keyboard language configuration. Keys that are used for shortcuts remain the same across all language configurations.









Some keys on your keyboard have two symbols on them. These keys can be used to type alternative characters or to perform secondary functions. The symbol that is shown on the lower part of the key refers to the character that is typed out when the key is pressed. If you press **Shift** and the key, the symbol that is shown on the upper part of the key is typed out. For example, if you press **2**, **2** is typed out; if you press **Shift + 2**, **@** is typed out.

The keys F1-F12 at the top row of the keyboard are function keys for multimedia control that is indicated by the icon at the bottom of the key. Press the function key to invoke the task represented by the icon. For example, pressing F1 disables or enables performance boost (see the table below).

However, if the function keys F1-F12 are needed for specific software applications, multimedia functionality can be disabled by pressing **fn + Esc**. Subsequently, multimedia control can be invoked by pressing **FN** and the respective function key. For example, disable or enable performance boost by pressing **fn + F1**.





NOTE: You can also define the primary behavior of the function keys (F1–F12) by changing **Function Key Behavior** in BIOS setup program.

Table 14. Function key primary behavior

Keys	Description
	Disable or enable Performance Boost.
	Enable or disable Stealth mode. When Stealth mode is enabled, AlienFX lighting is turned off. Performance settings change to Quiet mode. NOTE: The AlienFX lighting zone varies depending on the configuration of your computer.
	Adjust keyboard backlight brightness.
	Switch to an external display.
	Open Quick Settings.
	Decrease display brightness.
	Increase display brightness.
	Disable or enable the touchpad.

Your computer comes with preprogrammable macro keys that enable you to perform multiple actions with a single key press.

Table 15. Macro keys

Keys	Description
	Macro keys NOTE: You can configure modes and assign multiple tasks for the macro keys on the keyboard.
	
	
	
	

Your computer comes with dedicated keys that enable you to control specific features of the computer with a single key press.

Table 16. Keys to control specific features





Keys	Description
	Mute the microphone.
	Mute the speakers.
	Increase volume.

Table 16. Keys to control specific features (continued)

Keys	Description
	Decrease volume.
	Disable or enable the Windows key which activates the Windows Start screen when the Windows key is pressed. NOTE: Disabling the Windows key helps you to avoid accidental presses of the Windows key during gaming sessions.

Camera

The following table lists the camera specifications of your Alienware m16 R2.

Table 17. Camera specifications

Description	Values
Number of cameras	One
Camera type	One FHD-RGB Infrared camera
Camera location	Front camera
Camera sensor type	CMOS sensor technology
Camera resolution:	
Still image	2.07 megapixels
Video	1920 x 1080 (FHD) at 30 fps
Infrared camera resolution:	
Still image	0.23 megapixels
Video	640 x 360 at 30 fps
Diagonal viewing angle:	
Camera	80.2 degrees
Infrared camera	86.6 degrees

Touchpad

The following table lists the touchpad specifications of your Alienware m16 R2.

Table 18. Touchpad specifications

Description	Values
Touchpad resolution:	
Horizontal	>300 DPI
Vertical	749
Touchpad dimensions:	

Table 18. Touchpad specifications (continued)

Description		Values
	Horizontal	115 mm (4.53 in.)
	Vertical	70 mm (2.76 in.)
Touchpad gestures		For more information about touchpad gestures available on Windows, see the Microsoft Knowledge Base article at Microsoft Support Site .

Power adapter

The following table lists the power adapter specifications of your Alienware m16 R2.

Table 19. Power adapter specifications

Description		Option one	Option two
Type		280 W AC adapter	240 W SFF AC adapter
Connector dimensions:			
	External diameter	7.40 mm	7.40 mm
	Internal diameter	5.10 mm	5.10 mm
Power-adapter dimensions:			
	Height	26.50 mm (1.04 in.)	23.00 mm (0.91 in.)
	Width	105.00 mm (4.13 in.)	78.00 mm (3.07 in.)
	Depth	206.00 mm (8.10 in.)	152.00 mm (5.98 in.)
Input voltage		100 VAC–240 V	100 VAC–240 VAC
Input frequency		50 Hz–60 Hz	50 Hz–60 Hz
Input current (maximum)		3.50 A	3.50 A
Output current (continuous)		14.36 A	12.31 A
Rated output voltage		19.50 VDC	19.50 VDC
Temperature range:			
	Operating	32°C to 104°C (89.60°F to 219.20°F)	32°C to 95°C (89.60°F to 203.00°F)
	Storage	-40°C to 70°C (-40.00°F to 158.00°F)	-40°C to 158°C (-40.00°F to 316.40°F)
 CAUTION: Operating and storage temperature ranges may differ among components, so operating or storing the device outside these ranges may impact the performance of specific components.			

Battery

The following table lists the battery specifications of your Alienware m16 R2.

Table 20. Battery specifications

Description		Values
Battery type		6-cell lithium-ion (90 Wh)
Battery voltage		11.70 VDC
Battery weight (maximum)		0.34 kg (0.75 lb)
Battery dimensions:		
	Height	7.56 mm (0.30 in.)
	Width	294.90 mm (11.61 in)
	Depth	77.50 mm (3.05 in.)
Temperature range:		
	Operating	<ul style="list-style-type: none"> Charging: 0°C to 50°C (32°F to 122°F) Discharging: 0°C to 70°C (32°F to 158°F)
	Storage	-20°C to 60°C (-4°F to 140°F)
Battery operating time		Varies depending on operating conditions and can significantly reduce under certain power-intensive conditions.
Battery charging time (approximate) i NOTE: Control the charging time, duration, start and end time, and so on, using the Dell Power Manager application. For more information about Dell Power Manager, search in the Knowledge Base Resource at Dell Support Site .		When the computer is turned off: <ul style="list-style-type: none"> ExpressCharge2: from 0% to 80% in about 35 minutes. ExpressCharge: Two hours Standard Charge: Three hours
Coin-cell battery		None
⚠ CAUTION: Operating and storage temperature ranges may differ among components, so operating or storing the device outside these ranges may impact the performance of specific components.		
⚠ CAUTION: Dell Technologies recommends that you charge the battery regularly for optimal power consumption. If your battery charge is depleted, connect the power adapter, turn on your computer, and then restart your computer to reduce the power consumption.		

GPU—Integrated

The following table lists the specifications of the integrated Graphics Processing Unit (GPU) supported by your Alienware m16 R2.

Table 21. GPU—Integrated

Controller	Memory size	Processor
Intel Arc Graphics	Shared system memory	<ul style="list-style-type: none"> Intel Core Ultra processor 7 Intel Core Ultra processor 9

GPU—Discrete

The following table lists the specifications of the discrete Graphics Processing Unit (GPU) supported by your Alienware m16 R2.

Table 22. GPU—Discrete

Controller	Memory size	Memory type
NVIDIA GeForce RTX 4050 i NOTE: Available only on computers shipped with Intel Core Ultra 7 processor.	6 GB	GDDR6
NVIDIA GeForce RTX 4060	8 GB	GDDR6
NVIDIA GeForce RTX 4070	8 GB	GDDR6

External display support

The following table lists the external display support for your Alienware m16 R2.

Table 23. External display support

Graphics card	Supported external displays with laptop display enabled	Supported external displays with laptop display disabled
Intel Arc Graphics	2	2
NVIDIA GeForce RTX 4050 i NOTE: Available only on computers shipped with Intel Core Ultra 7 processor.	2	2
NVIDIA GeForce RTX 4060	2	2
NVIDIA GeForce RTX 4070	2	2

Display

The following table lists the display specifications of your Alienware m16 R2.

Table 24. Display specifications

Description	Values
Display type	16-inch, Quad High-Definition Plus (QHD+)
Touch options	Not supported
Display-panel technology	Wide Viewing Angle (WVA)
Display-panel dimensions (active area):	
Height	215.42 mm
Width	344.68 mm
Diagonal	406.46 mm

Table 24. Display specifications (continued)

Description	Values
Display-panel native resolution	2560 x 1600
Luminance (typical)	300 nits
Megapixels	4.1
Color gamut	sRGB 100%
Pixels Per Inch (PPI)	188.70
Contrast ratio (minimum)	1000:1
Response time (maximum)	<ul style="list-style-type: none"> • With overdrive: 3 ms • Without overdrive: 7 ms
Refresh rate	240
Horizontal view angle	+/- 85 degrees
Vertical view angle	+/- 85 degrees
Pixel pitch	0.13 mm
Power consumption (maximum)	6 W
Anti-glare vs glossy finish	Anti-glare

Operating and storage environment

This table lists the operating and storage specifications of your Alienware m16 R2.

Airborne contaminant level: G1 as defined by ISA-S71.04-1985

Table 25. Computer environment

Description	Operating	Storage
Temperature range	0°C to 35°C (32°F to 95°F)	-40°C to 65°C (-40°F to 149°F)
Relative humidity (maximum)	10% to 90% (non-condensing)	5% to 95% (non-condensing)
Vibration (maximum)*	0.66 GRMS	Not applicable
Shock (maximum)	140 G†	Not applicable
Altitude range	-15.20 m to 3048.00 m (-49.87 ft to 10000.00 ft)	-15.20 m to 10668.00 m (-49.87 ft to 35000.00 ft)
 CAUTION: Operating and storage temperature ranges may differ among components, so operating or storing the device outside these ranges may impact the performance of specific components.		

* Measured using a random vibration spectrum that simulates the user environment.

† Measured using a 2 ms half-sine pulse.

Dell support policy

For information about Dell support policy, search in the Knowledge Base Resource at [Dell Support Site](#).

Dell low blue light display

 **WARNING: Prolonged exposure to blue light from the display may lead to long-term effects such as eye strain, eye fatigue, or damage to the eyes.**

Blue light is a color in the light spectrum which has a short wavelength and high energy. Chronic exposure to blue light, particularly from digital sources may disrupt sleep patterns and cause long-term effects such as eye strain, eye fatigue, or damage to the eyes.

The display on this computer is designed to minimize blue light and complies with TÜV Rheinland's requirement for low blue light displays.

Low blue light mode is enabled at the factory, so no further configuration is necessary.

To reduce the risk of eye strain, it is also recommended that you:

- Position the display at a comfortable viewing distance between 20 and 28 inches (50 cm and 70 cm) from your eyes.
- Blink frequently to moisten your eyes, wet your eyes with water, or apply suitable eye drops.
- Look away from your display, and gaze at a distant object at 20 ft (609.60 cm) away for at least 20 seconds during each break.
- Take an extended break for 20 minutes every two hours.

Alienware Command Center

Alienware Command Center (AWCC) provides a single interface to customize and enhance the gaming experience. The AWCC dashboard displays most recently played or added games, and provides game-specific information, themes, profiles, and access to computer settings. You can quickly access settings such as game-specific profiles and themes, lighting, macros, and audio that are critical to the gaming experience.

AWCC also supports AlienFX 2.0. AlienFX enables you to create, assign, and share game-specific lighting maps to enhance the gaming experience. It also enables you to create your own individual lighting effects and apply them to the computer or attached peripherals. AWCC embeds Peripheral Controls to ensure a unified experience and the ability to link these settings to your computer or game.

This computer features the following AlienFX lighting zones:

- keyboard
- touchpad
- Alien head power button
- Alien head LED on the back of the display

 **NOTE:** Information about the location of AlienFX lighting zones on your computer is available in AWCC.

AWCC supports the following features:











- FX: Create and manage the AlienFX zones.
- Fusion: Fusion includes the ability to adjust game-specific Power Management, Sound Management, and Thermal Management features.
- Peripheral Management: Peripheral Management enables peripherals to appear in and be managed in Alienware Command Center. Supports key peripheral settings and associates with other functions such as profiles, macros, AlienFX, and game library.

AWCC also supports Sound Management, Thermal Controls, CPU, GPU, Memory (RAM) monitoring. For more information about AWCC, see the *Alienware Command Center Online Help* or search in the Knowledge Base Resource at [Dell Support Site](#).

Working inside your computer



Safety instructions

Use the following safety guidelines to protect your computer from potential damage and to ensure your personal safety. Unless otherwise noted, each procedure in this document assumes that you have read the safety information that shipped with your computer.

-  **WARNING:** Before working inside your computer, read the safety information that is shipped with your computer. For more safety best practices, see the Regulatory Compliance home page at [Dell Regulatory Compliance Home Page](#).
-  **WARNING:** Disconnect your computer from all power sources before opening the computer cover or panels. After you finish working inside the computer, replace all covers, panels, and screws before connecting your computer to an electrical outlet.
-  **CAUTION:** To avoid damaging the computer, ensure that the work surface is flat, dry, and clean.
-  **CAUTION:** To avoid damaging the components and cards, handle them by their edges, and avoid touching the pins and the contacts.
-  **CAUTION:** You should only perform troubleshooting and repairs as authorized or directed by the Dell technical assistance team. Damage due to servicing that is not authorized by Dell is not covered by your warranty. See the safety instructions that is shipped with the product or at [Dell Regulatory Compliance Home Page](#).
-  **CAUTION:** Before touching anything inside your computer, ground yourself by touching an unpainted metal surface, such as the metal at the back of the computer. While you work, periodically touch an unpainted metal surface to dissipate static electricity which could harm internal components.
-  **CAUTION:** When you disconnect a cable, pull it by its connector or its pull tab, not the cable itself. Some cables have connectors with locking tabs or thumbscrews that you must disengage before disconnecting the cable. When disconnecting cables, keep them evenly aligned to avoid bending the connector pins. When connecting cables, ensure that the ports and the connectors are correctly oriented and aligned.
-  **CAUTION:** Press and eject any installed card from the media-card reader.
-  **CAUTION:** Exercise caution when handling rechargeable Li-ion batteries in laptops. Swollen batteries should not be used and should be replaced and disposed properly.
-  **NOTE:** The color of your computer and certain components may differ from what is shown in this document.

Before working inside your computer

Steps

1. Save and close all open files and exit all open applications.
2. Shut down your computer. For Windows operating system, click **Start** >  **Power** > **Shut down**.
 -  **NOTE:** If you are using a different operating system, see the documentation of your operating system for shut-down instructions.
3. Disconnect your computer and all attached devices from their electrical outlets.
4. Disconnect all attached network devices and peripherals, such as keyboard, mouse, and monitor from your computer.

5. Remove any media card and optical disk from your computer, if applicable.
6. Enter the service mode, if you can turn on your computer.

Service Mode

Service Mode is used to cut off power, without disconnecting the battery cable from the system board prior to conducting repairs in the computer.

 **CAUTION:** If you are unable to turn on the computer to put it into Service Mode, or the computer does not support Service Mode, proceed to disconnect the battery cable. To disconnect the battery cable, follow the steps in [Removing the battery](#).

 **NOTE:** Ensure that your computer is shut down and the AC adapter is disconnected.

- a. Hold the **** key on the keyboard and press the power button for 3 seconds or until the Dell logo appears on the screen.
- b. Press any key to continue.
- c. If the AC adapter is not disconnected, a message prompting you to remove the AC adapter appears on the screen. Remove the AC adapter and then press any key to continue the **Service Mode** process. The **Service Mode** process automatically skips the following step if the **Owner Tag** of the computer is not set up in advance by the user.
- d. When the **ready-to-proceed** message appears on the screen, press any key to proceed. The computer emits three short beeps and shuts down immediately.
- e. Once the computer shuts down, it has successfully entered Service Mode.

 **NOTE:** If you are unable to turn on your computer or unable to enter Service Mode, skip this process.

Safety precautions

The safety precautions chapter details the primary steps to be taken before performing any disassembly instructions.

Observe the following safety precautions before you perform any installation or break-fix procedures involving disassembly or reassembly:

- Turn off the computer and all attached peripherals.
- Disconnect the computer and all attached peripherals from AC power.
- Disconnect all network cables, telephone, and telecommunications lines from the computer.
- Use an ESD field service kit when working inside any notebook to avoid electrostatic discharge (ESD) damage.
- After removing any computer component, carefully place the removed component on an anti-static mat.
- Wear shoes with non-conductive rubber soles to reduce the chance of getting electrocuted.
- Unplugging, pressing, and holding the power button for 15 seconds should discharge residual power in the system board.

Standby power

Dell products with standby power must be unplugged before you open the case. Systems that incorporate standby power are powered while turned off. The internal power enables the computer to be remotely turned on (Wake-on-LAN) and suspended into a sleep mode and has other advanced power management features.

Bonding

Bonding is a method for connecting two or more grounding conductors to the same electrical potential. This is done by using a field service electrostatic discharge (ESD) kit. When connecting a bonding wire, ensure that it is connected to bare metal and never to a painted or nonmetal surface. The wrist strap should be secure and in full contact with your skin, and ensure that you remove all jewelry such as watches, bracelets, or rings prior to bonding yourself and the equipment.

Electrostatic discharge—ESD protection

ESD is a major concern when you handle electronic components, especially sensitive components such as expansion cards, processors, memory modules, and system boards. Slight charges can damage circuits in ways that may not be obvious, such as intermittent problems or a shortened product life span. As the industry pushes for lower power requirements and increased density, ESD protection is an increasing concern.

Due to the increased density of semiconductors used in recent Dell products, the sensitivity to static damage is now higher than in previous Dell products. For this reason, some previously approved methods of handling parts are no longer applicable.

Two recognized types of ESD damage are catastrophic and intermittent failures.

- **Catastrophic** – Catastrophic failures represent approximately 20 percent of ESD-related failures. The damage causes an immediate and complete loss of device functionality. An example of catastrophic failure is a memory DIMM that has received a static shock and immediately generates a "No POST/No Video" symptom with a beep code that is emitted for missing or nonfunctional memory.
- **Intermittent** – Intermittent failures represent approximately 80 percent of ESD-related failures. The high rate of intermittent failures means that most of the time when damage occurs, it is not immediately recognizable. The DIMM receives a static shock, but the tracing is merely weakened and does not immediately produce outward symptoms that are related to the damage. The weakened trace may take weeks or months to melt, and in the meantime may cause degradation of memory integrity, intermittent memory errors, and so on.

The more difficult type of damage to recognize and troubleshoot is the intermittent (also called latent or "walking wounded") failure.

Perform the following steps to prevent ESD damage:

- Use a wired ESD wrist strap that is properly grounded. Wireless anti-static straps do not provide adequate protection. Touching the chassis before handling parts does not ensure adequate ESD protection on parts with increased sensitivity to ESD damage.
- Handle all static-sensitive components in a static-safe area. If possible, use anti-static floor pads and workbench pads.
- When unpacking a static-sensitive component from its shipping carton, do not remove the component from the anti-static packing material until you are ready to install the component. Before unwrapping the anti-static packaging, ensure that you discharge static electricity from your body.
- Before transporting a static-sensitive component, place it in an anti-static container or packaging.

ESD Field Service kit

The unmonitored Field Service kit is the most commonly used service kit. Each Field Service kit includes three main components: anti-static mat, wrist strap, and bonding wire.

Components of an ESD field service kit

The components of an ESD field service kit are:

- **Anti-Static Mat** – The anti-static mat is dissipative and parts can be placed on it during service procedures. When using an anti-static mat, your wrist strap should be snug and the bonding wire should be connected to the mat and to any bare metal on the computer being worked on. Once deployed properly, service parts can be removed from the ESD bag and placed directly on the mat. ESD-sensitive items are safe in your hand, on the ESD mat, in the computer, or inside an ESD bag.
- **Wrist Strap and Bonding Wire** – The wrist strap and bonding wire can be either directly connected between your wrist and bare metal on the hardware if the ESD mat is not required, or connected to the anti-static mat to protect hardware that is temporarily placed on the mat. The physical connection of the wrist strap and bonding wire between your skin, the ESD mat, and the hardware is known as bonding. Use only Field Service kits with a wrist strap, mat, and bonding wire. Never use wireless wrist straps. Always be aware that the internal wires of a wrist strap are prone to damage from normal wear and tear, and must be checked regularly with a wrist strap tester in order to avoid accidental ESD hardware damage. It is recommended to test the wrist strap and bonding wire at least once per week.
- **ESD Wrist Strap Tester** – The wires inside an ESD strap are prone to damage over time. When using an unmonitored kit, it is a best practice to regularly test the strap prior to each service call, and at a minimum, test once per week. A wrist strap tester is the best method for doing this test. If you do not have your own wrist strap tester, check with your regional office to find out if they have one. To perform the test, plug the bonding-wire of wrist-strap into the tester while it is strapped to your wrist and push the button to test. A green LED is lit if the test is successful; a red LED is lit and an alarm sounds if the test fails.
- **Insulator Elements** – It is critical to keep ESD sensitive devices, such as plastic heat sink casings, away from internal parts that are insulators and often highly charged.
- **Working Environment** – Before deploying the ESD Field Service kit, assess the situation at the customer location. For example, deploying the kit for a server environment is different than for a desktop or laptop environment. Servers are typically installed in a rack within a data center; desktops or laptops are typically placed on office desks or cubicles. Always look for a large open flat work area that is free of clutter and large enough to deploy the ESD kit with additional space to accommodate the type of computer that is being repaired. The workspace should also be free of insulators that can cause an ESD event. On the work area, insulators such as Styrofoam and other plastics should always be moved at least 12 inches or 30 centimeters away from sensitive parts before physically handling any hardware components.

- **ESD Packaging** – All ESD-sensitive devices must be shipped and received in static-safe packaging. Metal, static-shielded bags are preferred. However, you should always return the damaged part using the same ESD bag and packaging that the new part arrived in. The ESD bag should be folded over and taped shut and all the same foam packing material should be used in the original box that the new part arrived in. ESD-sensitive devices should be removed from packaging only at an ESD-protected work surface, and parts should never be placed on top of the ESD bag because only the inside of the bag is shielded. Always place parts in your hand, on the ESD mat, in the computer, or inside an anti-static bag.
- **Transporting Sensitive Components** – When transporting ESD sensitive components such as replacement parts or parts to be returned to Dell, it is critical to place these parts in anti-static bags for safe transport.

ESD protection summary

It is recommended to always use the traditional wired ESD grounding wrist strap and protective anti-static mat when servicing Dell products. In addition, it is critical to keep sensitive parts separate from all insulator parts while performing service and use anti-static bags for transporting sensitive components.

Transporting sensitive components

When transporting ESD sensitive components such as replacement parts or parts to be returned to Dell, it is critical to place these parts in anti-static bags for safe transport.

After working inside your computer

About this task

 **CAUTION:** Leaving stray or loose screws inside your computer may severely damage your computer.

Steps

1. Replace all screws and ensure that no stray screws remain inside your computer.
2. Connect any external devices, peripherals, or cables you removed before working on your computer.
3. Replace any media cards, discs, or any other parts that you removed before working on your computer.
4. Connect your computer and all attached devices to their electrical outlets.
 -  **NOTE:** To exit service mode, ensure to connect the AC adapter to the power-adapter port on your computer.
5. Press the power button to turn on the computer. Your computer will automatically return to normal functioning mode.

BitLocker

 **CAUTION:** If BitLocker is not suspended before updating the BIOS, the next time you reboot the system it will not recognize the BitLocker key. You will then be prompted to enter the recovery key to progress, and the system will ask for the recovery key on each reboot. If the recovery key is not known, this can result in data loss or an unnecessary operating system reinstall. For more information about this subject, see Knowledge Article: [updating the BIOS on Dell systems with BitLocker enabled](#).

The installation of the following components triggers BitLocker:

- Hard disk drive or solid-state drive
- System board

Recommended tools

The procedures in this document may require the following tools:

- Phillips screwdriver #0
- Plastic scribe

Screw list

- NOTE:** When removing screws from a component, it is recommended to note the screw type, the quantity of screws, and then place them in a screw storage box. This is to ensure that the correct number of screws and correct screw type is restored when the component is replaced.
- NOTE:** Some computers have magnetic surfaces. Ensure that the screws are not left attached to such surfaces when replacing a component.
- NOTE:** Screw color may vary with the configuration ordered.

Table 26. Screw list

























Component	Screw type	Quantity	Screw image
Base cover	M2x7 (captive screw)	2	
	M2x6	6	
Rear I/O cover	M2x5	4	
	M2x4	2	
Solid state drive in each slot	M2x3	1	
	M1.6x4	1	
Wireless-card bracket	M2x3.5	1	
Battery	M2x4	4	
	M2x4.5	4	
Power-adaptor port bracket	M2x3	2	
Fan and heat-sink assembly	M2x7.55 (captive screw)	6	
	M2x3	6	
Display-assembly hinges	M2.5x3.5	6	
Touchpad	M2x2.5	2	
Touchpad dome bracket	M2x3	4	
Touchpad brackets	M2x3	4	
Keyboard-controller board	M2x2.5	1	

Table 26. Screw list (continued)

Component	Screw type	Quantity	Screw image
I/O board	M2x2.5	2	
Type-C bracket	M2x4	2	
	M2x3	2	
Power button bracket	M2x2.5	2	
System board	M2x3	8	
Audio board	M2x2.5	2	
Display-hinge covers	M1.6x2.5	2	

Major components of Alienware m16 R2

The following image shows the major components of Alienware m16 R2.

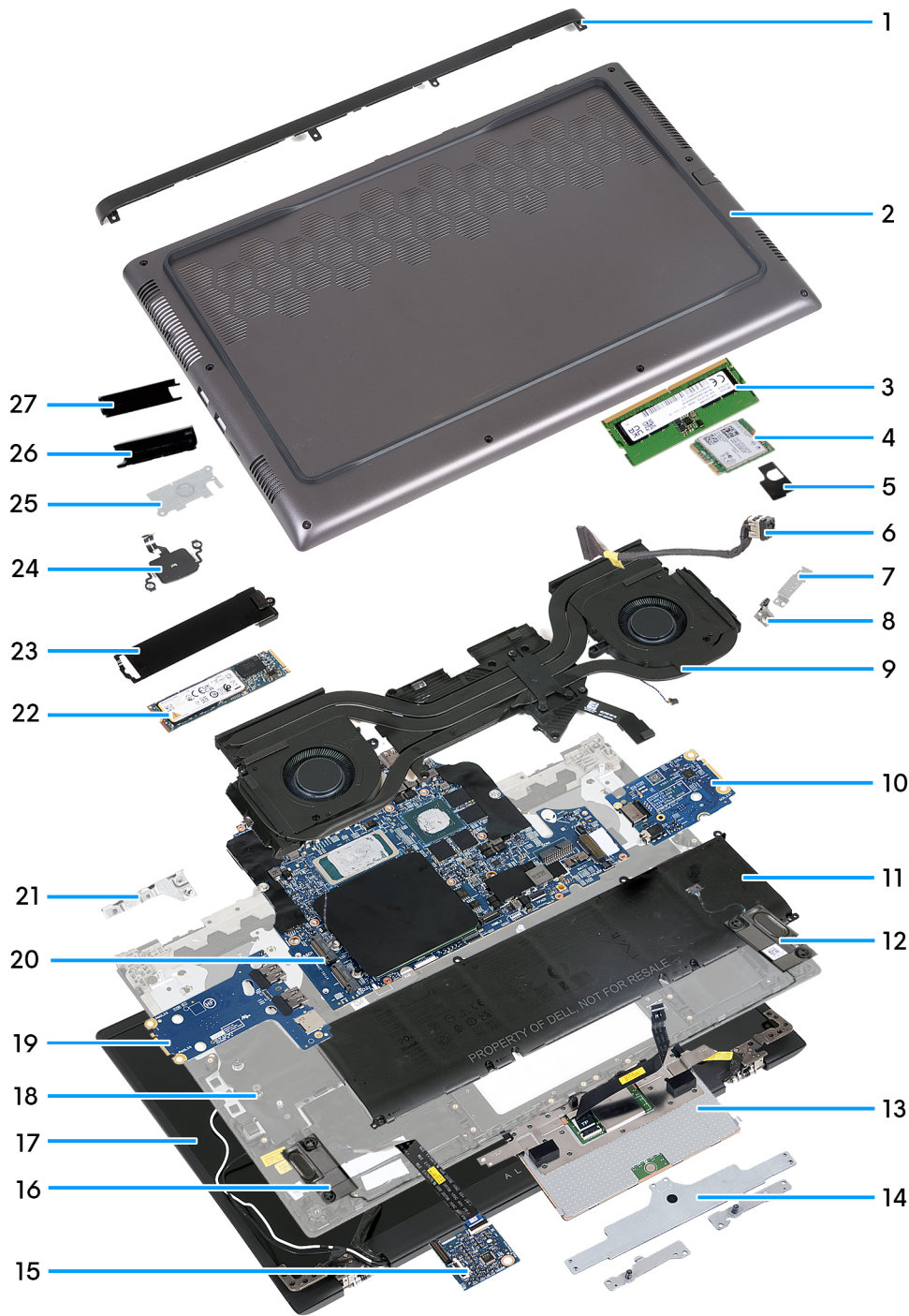

- 1. Rear I/O cover
- 2. Base cover
- 3. Memory module
- 4. Wireless card
- 5. Wireless-card bracket
- 6. Power-adaptor port
- 7. Power-adaptor port bracket
- 8. Thermal filler
- 9. Fan and heat-sink assembly
- 10. Audio board
- 11. Battery
- 12. Left speaker

13. Touchpad
14. Touchpad brackets - dome bracket and two front brackets
15. Keyboard-controller board
16. Right speaker
17. Display assembly
18. Palm rest and keyboard assembly
19. I/O board
20. System board
21. Type-C bracket
22. Solid-state drive
23. Solid-state drive thermal shield
24. Power button
25. Power-button bracket
26. Left display-hinge cover
27. Right display-hinge cover

 **NOTE:** Dell provides a list of components and their part numbers for the original system configuration purchased. These parts are available according to warranty coverage purchased by the customer. Contact your Dell sales representative for purchase options.

Removing and installing Customer Replaceable Units (CRUs)

The replaceable components in this chapter are Customer Replaceable Units (CRUs).

 **CAUTION:** Customers can replace only the Customer Replaceable Units (CRUs) following the safety precautions and replacement procedures.

 **NOTE:** The images in this document may differ from your computer depending on the configuration you ordered.

Base cover

Removing the base cover

Prerequisites

Follow the procedure in [Before working inside your computer](#).

 **NOTE:** Ensure that your computer is in Service Mode. For more information, see [Before working inside your computer](#).

 **CAUTION:** If you are unable to turn on the computer, if your computer is unable to enter Service Mode, or the computer does not support Service Mode, proceed to disconnect the battery cable.

About this task

The following image(s) indicate the location of the base cover and provides a visual representation of the removal procedure.

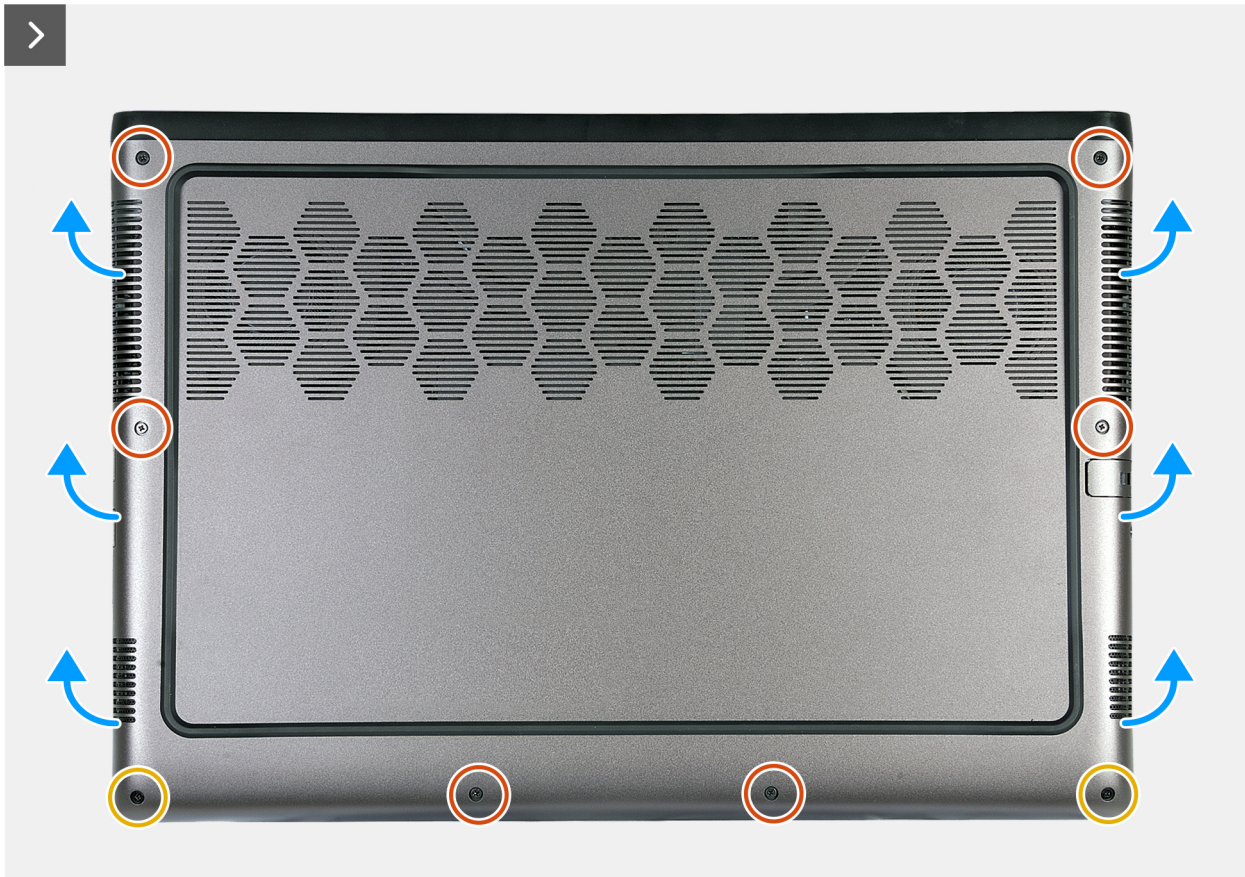

Figure 9. Removing the base cover

Steps

1. Remove the six screws (M2x6) that secure the base cover to the palm rest and keyboard assembly.
2. Loosen the two captive screws (M2x7) that secure the base cover to the palm rest and keyboard assembly.
3. Using a plastic scribe, pry the base cover from the bottom left and continue to work on the sides to open the base cover.

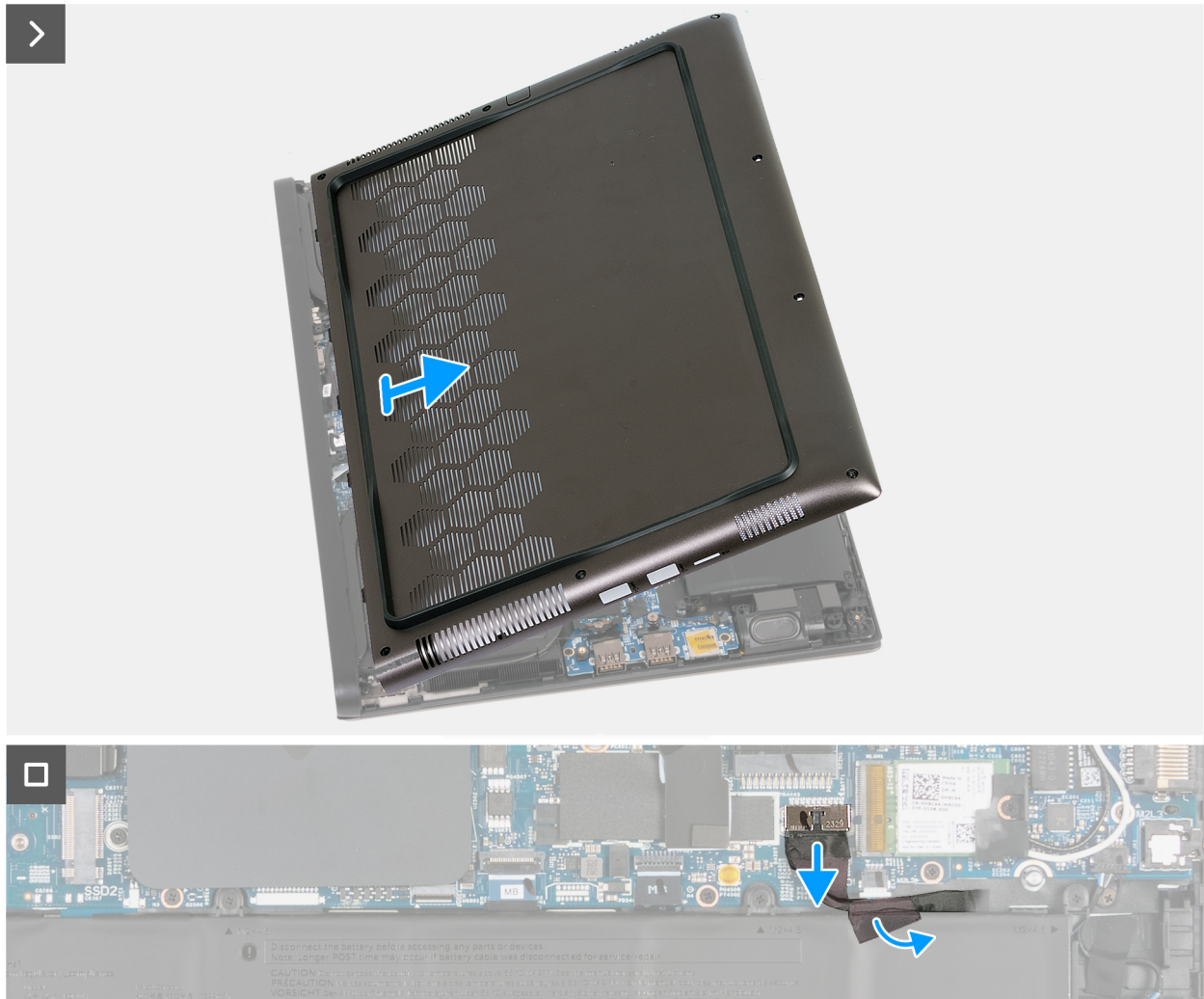
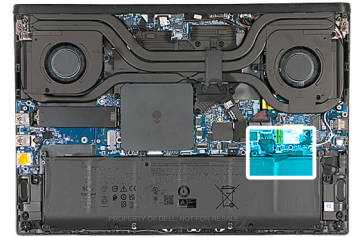

Figure 10. Removing the base cover

4. Slide and lift the base cover off the palm rest and keyboard assembly.
5. Peel off the tape that secures the battery cable to the battery.
6. Disconnect the battery cable from the connector (BATT1) on the system board.

Installing the base cover

Prerequisites

If you are replacing a component, remove the existing component before performing the installation process.

About this task

The following image(s) indicate the location of the base cover and provides a visual representation of the installation procedure.



6x
M2x6



2x

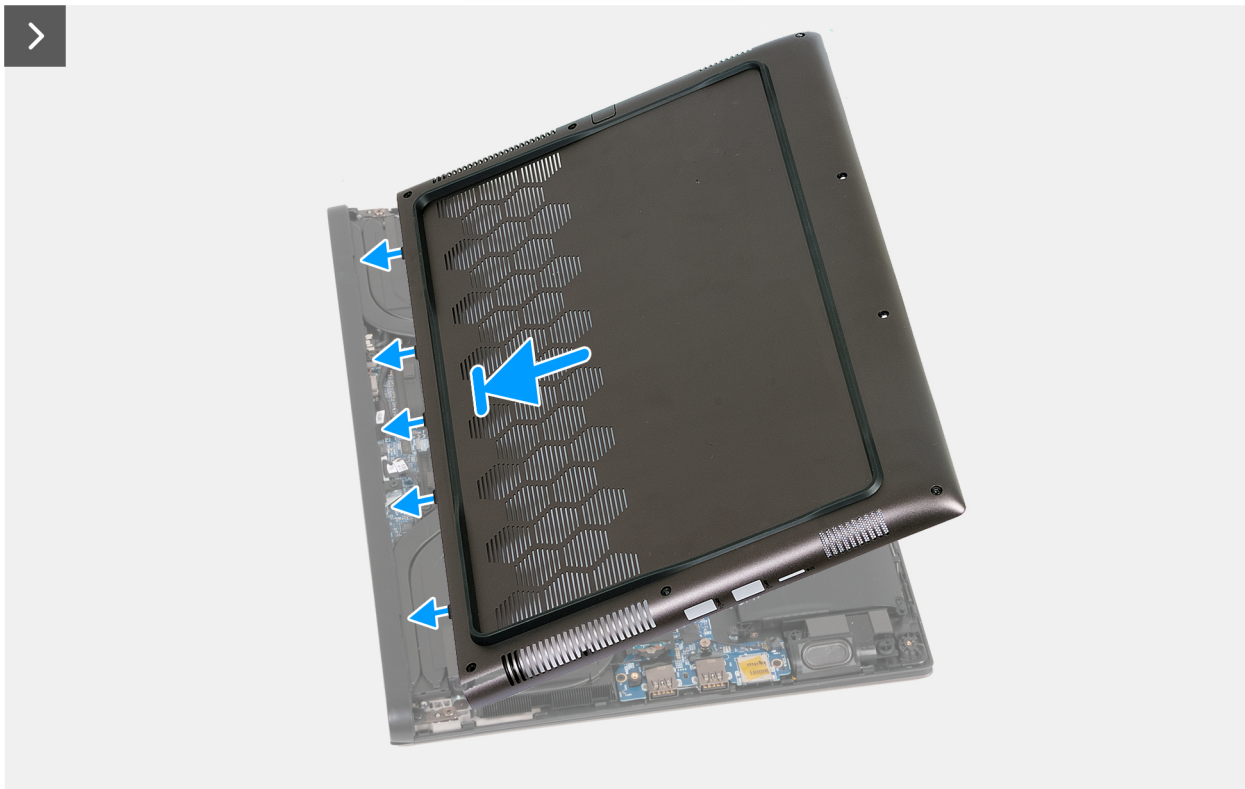
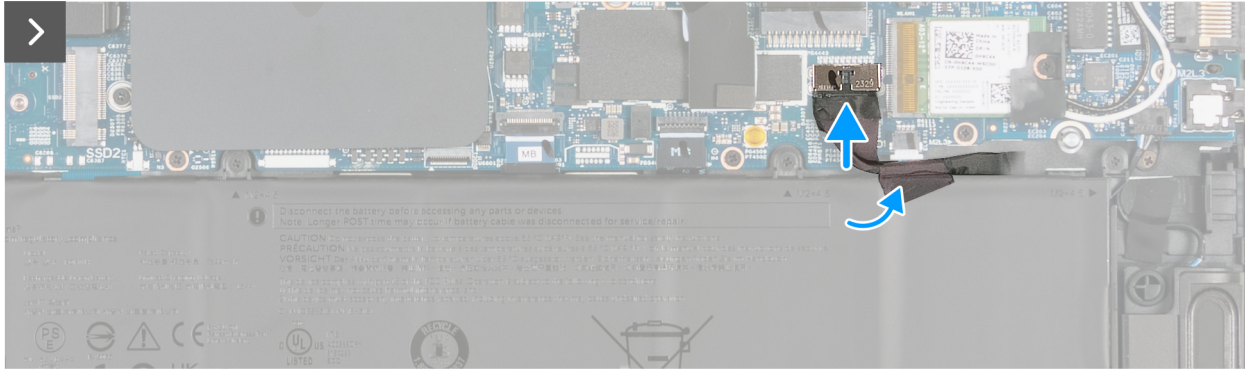
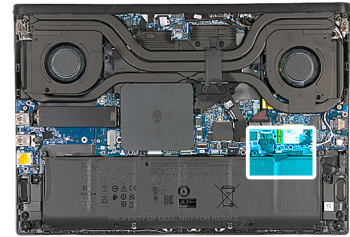

Figure 11. Installing the base cover

Steps

1. Connect the battery cable to connector (BATT1) on the system board.
2. Adhere the tape that secures the battery cable to the battery.
3. Slide the tabs on the top of the base cover under the I/O-cover and snap the base cover to the palm rest and keyboard assembly.

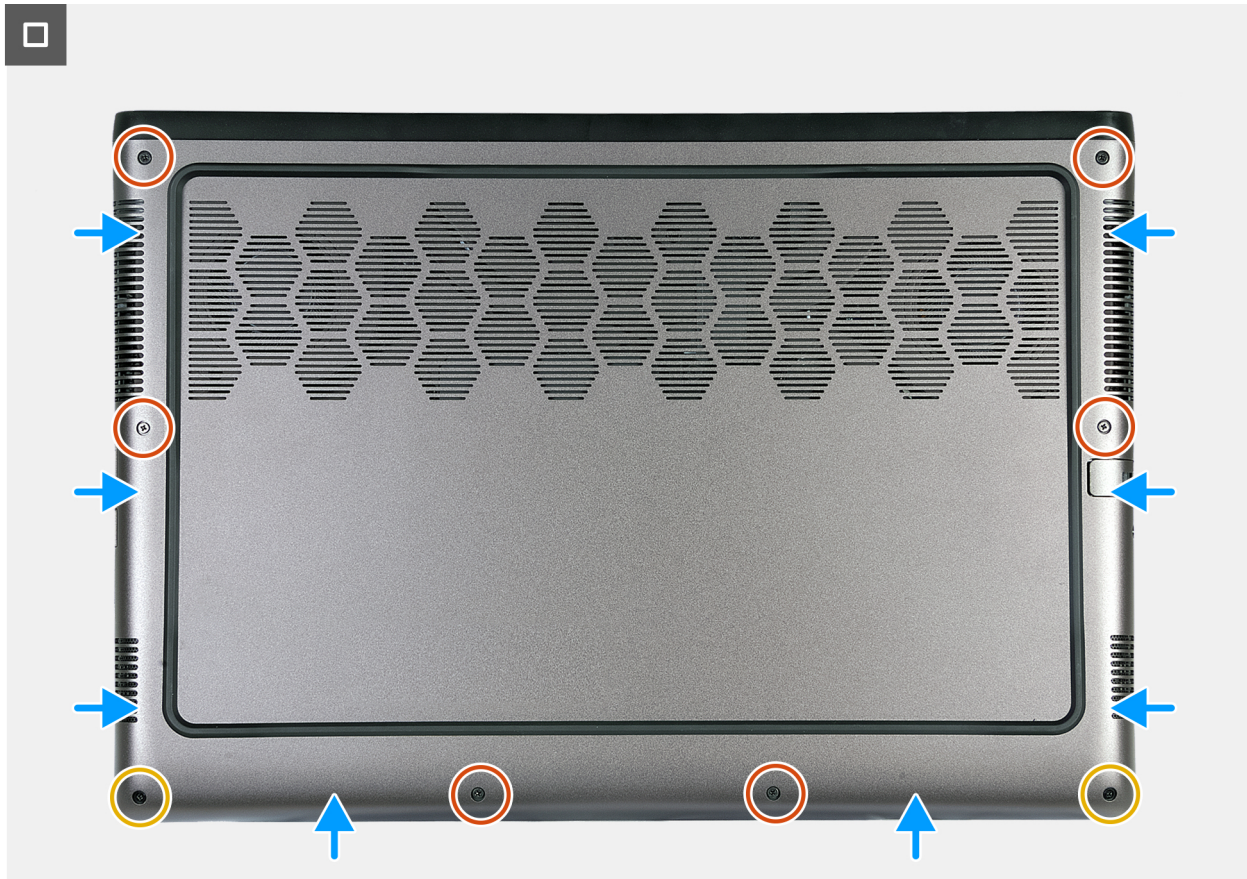

Figure 12. Installing the base cover

4. Tighten the two captive screws (M2x7) that secure the base cover to the palm rest and keyboard assembly.
5. Replace the six screws (M2x6) that secure the base cover to the palm rest and keyboard assembly.

Next steps

Follow the procedure in [After working inside your computer](#).

i **NOTE:** Ensure that your computer is in Service Mode. For more information, see [Before working inside your computer](#).

Memory module

Removing the memory

Prerequisites

1. Follow the procedure in [Before working inside your computer](#).
2. Remove the [base cover](#).

About this task

i **NOTE:** This computer may have up to two memory modules installed.

The following images indicate the location of the memory and provide a visual representation of the removal procedure.

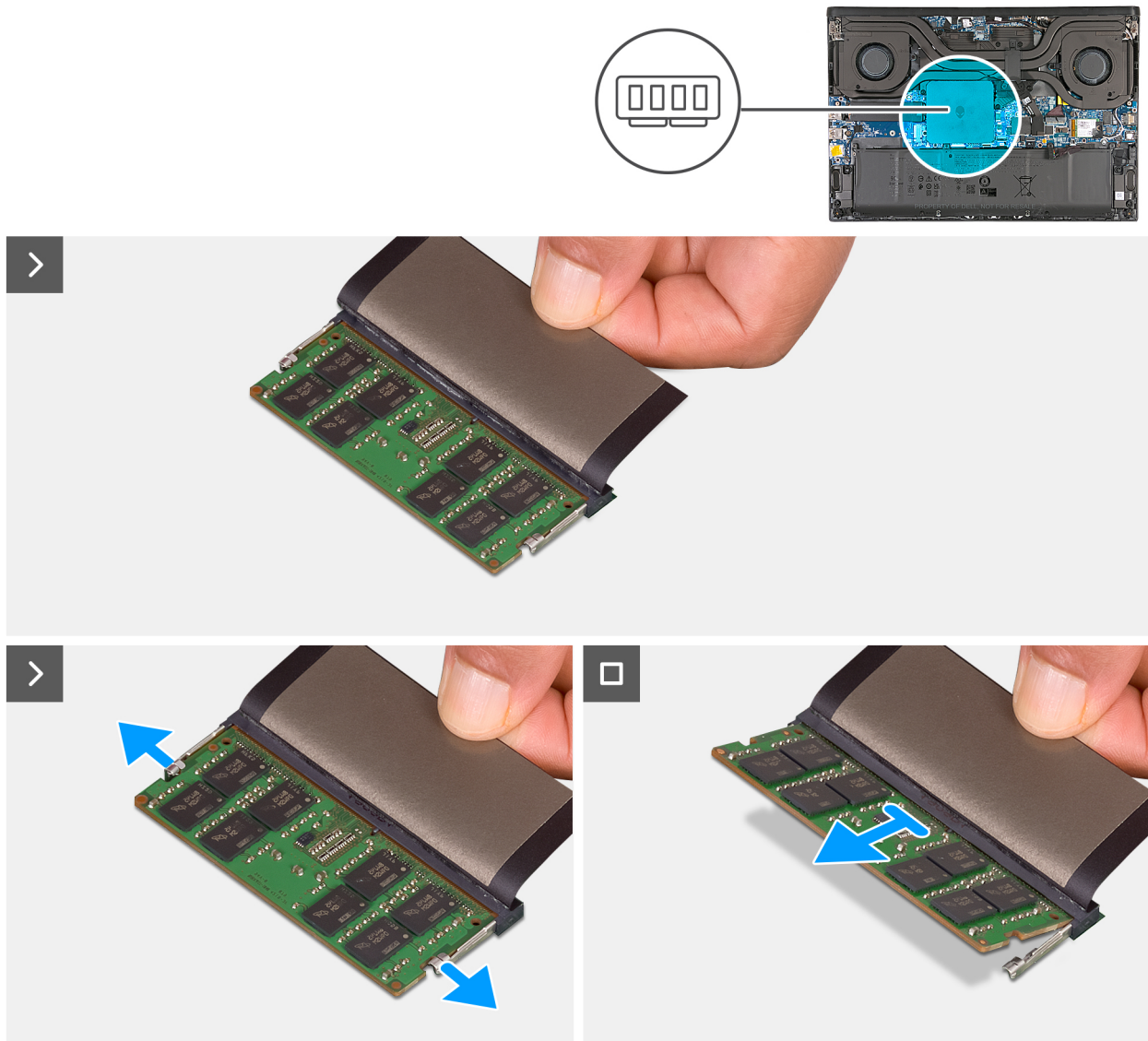

Figure 13. Removing the memory

Steps

1. Lift the Mylar to access the memory.
2. Use your fingertips to carefully spread apart the securing-clips on each end of the memory-module slot until the memory module pops up.
3. Slide and remove the memory module from the memory-module slot.

CAUTION: To prevent damage to the memory module, hold the memory module by the edges. Do not touch the metallic contacts on the memory module as electrostatic discharge (ESD) can inflict severe damage on the components. To read more about ESD protection, see [ESD protection](#).

- NOTE:** Repeat the steps to remove any other memory module installed in your computer.
- NOTE:** Note the slot and the orientation of the memory module in order to replace it in the correct slot.
- NOTE:** If the memory module is difficult to remove, gently ease the memory module back and forth to remove it from the slot.

Installing the memory

Prerequisites

If you are replacing a component, remove the existing component before performing the installation process.

About this task

NOTE: Up to two memory modules may be installed into this computer.

The following images indicate the location of the memory and provide a visual representation of the installation procedure.

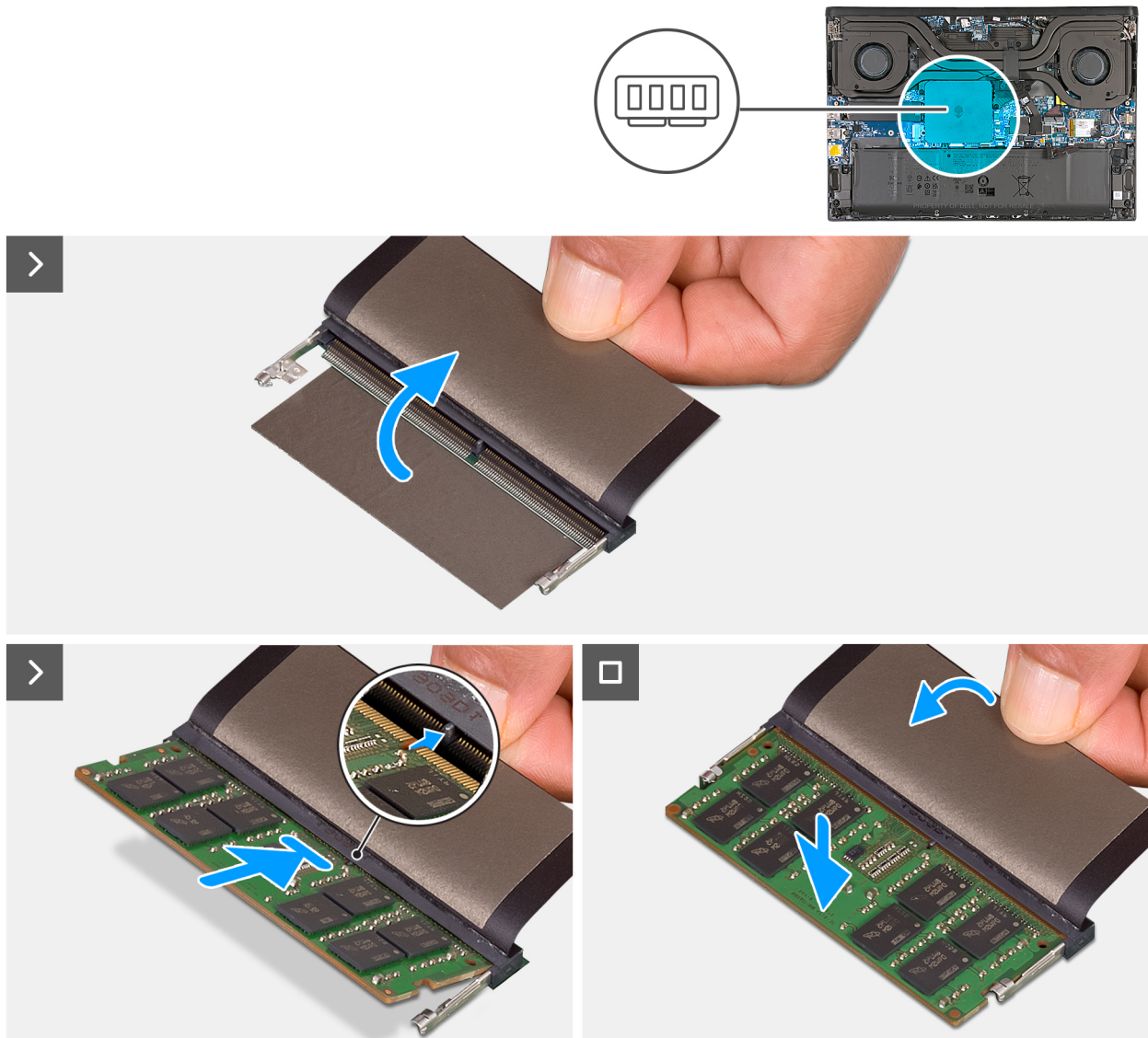

Figure 14. Installing the memory

Steps

1. Lift the Mylar to access the memory-module slot.
2. Align the notch on the memory module with the tab on the memory-module slot.

CAUTION: To prevent damage to the memory module, hold the memory module by the edges. Do not touch the metallic contacts on the memory module as electrostatic discharge (ESD) can inflict severe damage on the components. To read more about ESD protection, see [ESD protection](#).

3. Slide the memory module firmly at an angle into the memory-module slot.
4. Press the memory module down until it clicks into place.
 - NOTE:** Repeat the steps to install a second memory into your computer.
 - NOTE:** The securing clips return to a locked position. If you do not hear the click, remove the memory module and reinstall it.
5. Replace the Mylar to cover the memory-module slots.

Next steps

1. Install the [base cover](#).
2. Follow the procedure in [After working inside your computer](#).

Solid-state drive

Removing the solid-state drive

Prerequisites

1. Follow the procedure in [Before working inside your computer](#).
2. Remove the [base cover](#).

About this task

The following image(s) indicate the location of the solid-state drive in SSD1 slot, SSD2 slot, or both. It also provides a visual representation of the removal procedure.

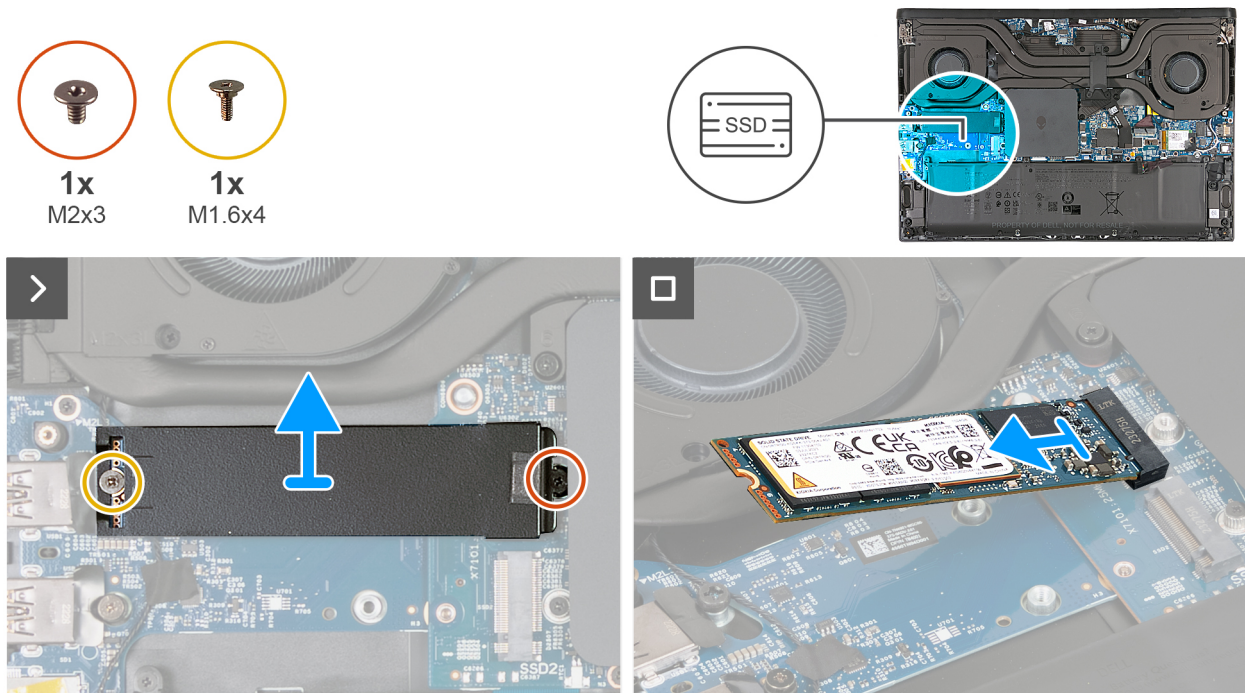

Figure 15. Removing the solid-state drive

Steps

1. Remove the screw (M2x3) that secures the thermal shield to the system board.
2. Remove the screw (M1.6x4) that secures the thermal shield to the I/O board.
3. Lift the thermal shield off the solid-state drive.

- Slide and lift the solid-state drive from the solid-state drive slot (SSD1 or SSD2).

Installing the solid-state drive

Prerequisites

If you are replacing a component, remove the existing component before performing the installation process.

About this task

The following image(s) indicate the location of the solid-state drive in SSD1 slot, SSD2 slot, or both. It also provides a visual representation of the installation procedure.

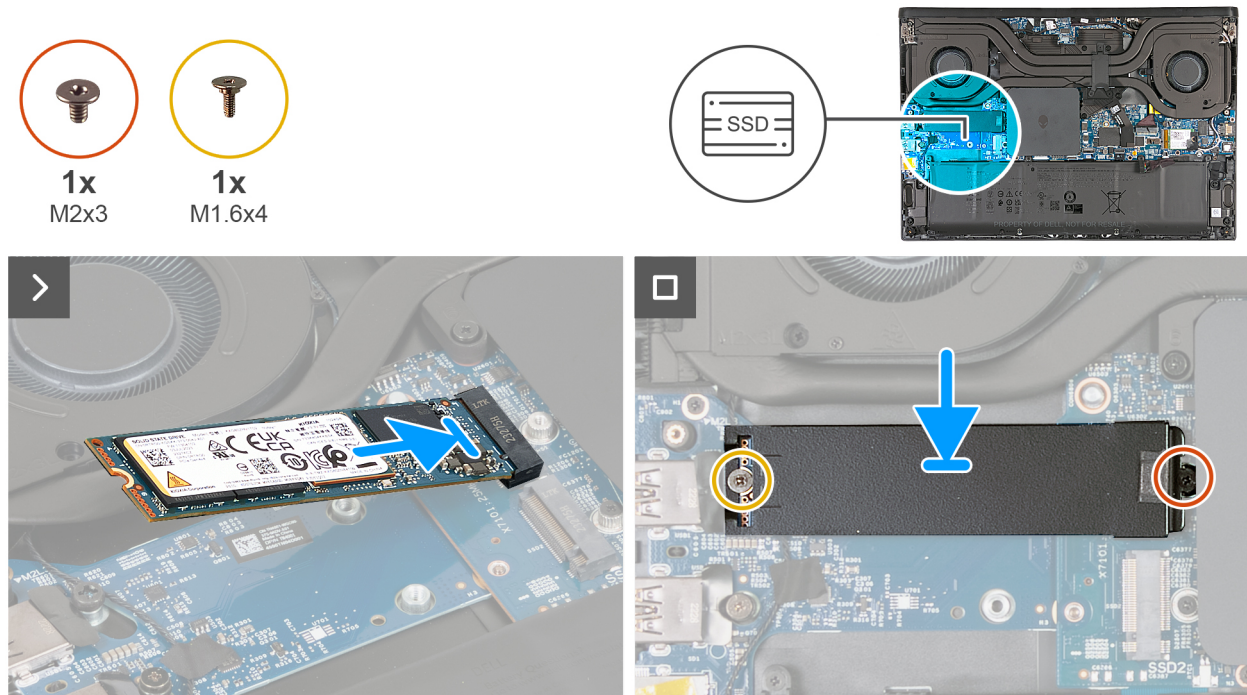

Figure 16. Installing the solid-state drive

Steps

- Align the notch on the solid-state drive with the tab on the solid-state drive slot (SSD1 or SSD2) on the system board.
- Slide the solid-state drive into the solid-state drive slot (SSD1 or SSD2) on the system board.
- Slide the tab on the thermal shield into the solid-state drive slot.
- Align the screw holes on the thermal shield with the screw holes on the system board and I/O board.
- Replace the screw (M1.6x4) that secures the thermal shield to the I/O board.
- Replace the screw (M2x3) that secures the thermal shield to the system board.

Next steps

- Install the [base cover](#).
- Follow the procedure in [After working inside your computer](#).

Wireless card

Removing the wireless card

Prerequisites

1. Follow the procedure in [Before working inside your computer](#).
2. Remove the [base cover](#).

About this task

The following image(s) indicate the location of the wireless card and provides a visual representation of the removal procedure.

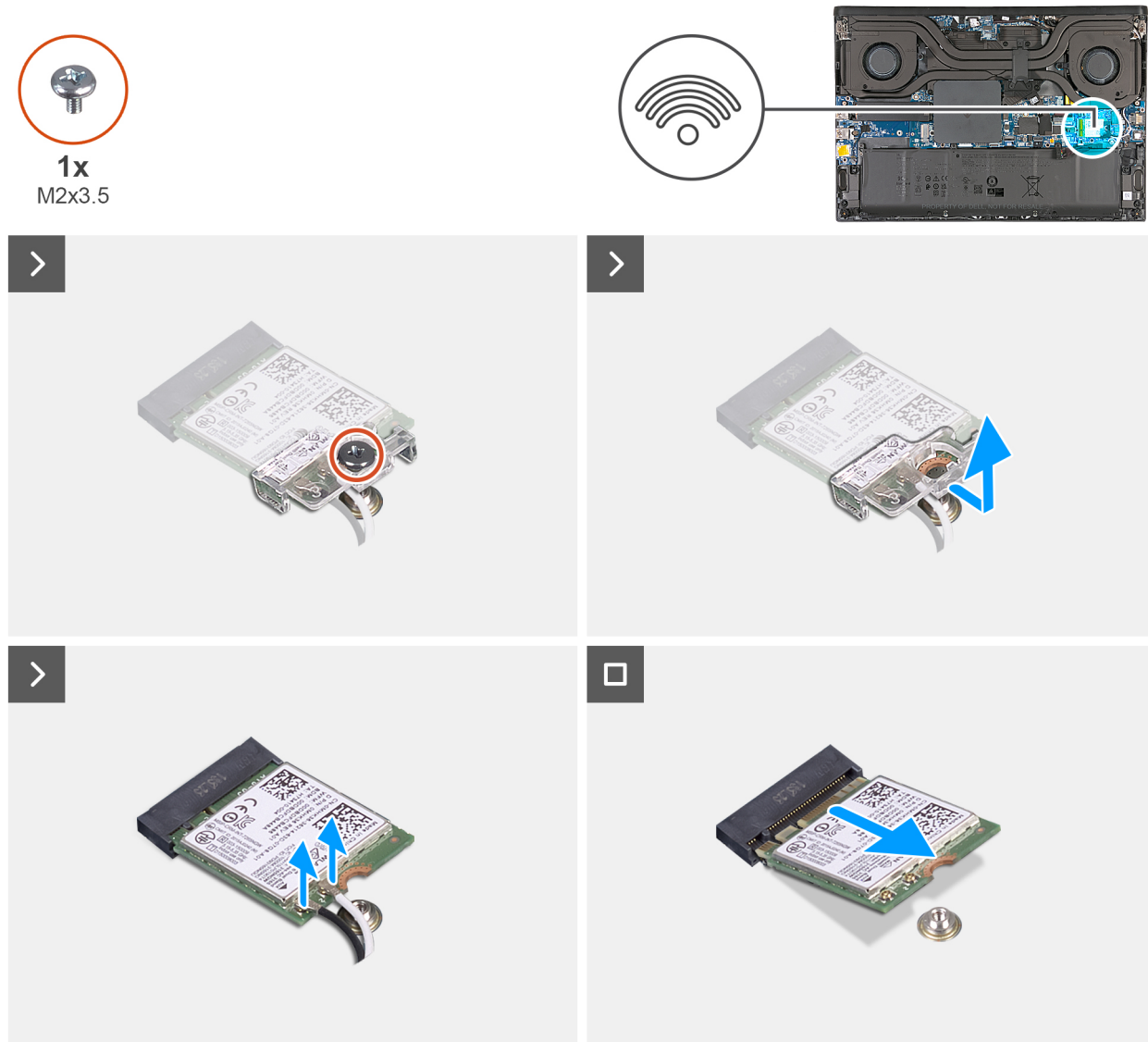

Figure 17. Removing the wireless card

Steps

1. Remove the screw (M2x3.5) that secures the wireless-card bracket to the wireless card and system board.
2. Slide and lift the wireless-card bracket off the wireless card.
3. Disconnect the antenna cables from the wireless card.
4. Slide and remove the wireless card at an angle from the wireless-card slot.

Installing the wireless card

Prerequisites

If you are replacing a component, remove the existing component before performing the installation process.

About this task

The following image(s) indicate the location of the wireless card and provides a visual representation of the installation procedure.



Figure 18. Installing the wireless card

Steps

1. Connect the antenna cables to the wireless card.

NOTE: The following table provides the antenna-cable color scheme for the wireless card that supports your computer.

Table 27. Antenna-cable color scheme

Connectors on the wireless card	Antenna-cable color	Label marking
Main	White	MAIN 2 △ (white triangle)

Table 27. Antenna-cable color scheme (continued)

Connectors on the wireless card	Antenna-cable color	Label marking	
Auxiliary	Black	AUX 1	▲ (black triangle)





2. Align the notch on the wireless card with the tab on the wireless-card slot and insert the wireless card at an angle into the slot.
3. Align the screw hole on the wireless-card bracket with the screw hole on the wireless card and palm rest and keyboard assembly.
4. Replace the screw (M2x3.5) that secures the wireless-card bracket to the wireless card and the system board.

Next steps

1. Install the [base cover](#).
2. Follow the procedure in [After working inside your computer](#).

Removing and installing Field Replaceable Units (FRUs)

The replaceable components in this chapter are Field Replaceable Units (FRUs).

-  **CAUTION:** The information in this removing and installing FRU's section is intended for authorized service technicians only.
-  **CAUTION:** To avoid any potential damage to the component or loss of data, ensure that an authorized service technician replaces the Field Replaceable Units (FRUs).
-  **CAUTION:** Dell Technologies recommends that this set of repairs, if needed, to be conducted by trained technical repair specialists.
-  **CAUTION:** As a reminder, your warranty does not cover damages that may occur during FRU repairs that are not authorized by Dell Technologies.
-  **NOTE:** The images in this document may differ from your computer depending on the configuration you ordered.

Battery

Rechargeable Li-ion battery precautions

-  **CAUTION:**
 - Exercise caution when handling rechargeable Li-ion batteries.
 - Discharge the battery completely before removing it. Disconnect the AC power adapter from the computer and operate the computer solely on battery power—the battery is fully discharged when the computer no longer turns on when the power button is pressed.
 - Do not crush, drop, mutilate, or penetrate the battery with foreign objects.
 - Do not expose the battery to high temperatures, or disassemble battery packs and cells.
 - Do not apply pressure to the surface of the battery.
 - Do not bend the battery.
 - Do not use tools of any kind to pry on or against the battery.
 - Ensure any screws during the servicing of this product are not lost or misplaced, to prevent accidental puncture or damage to the battery and other computer components.
 - If the battery gets stuck inside your computer as a result of swelling, do not try to release it as puncturing, bending, or crushing a rechargeable Li-ion battery can be dangerous. In such an instance, contact Dell technical support for assistance. See [Contact Support at Dell Support Site](#).
 - Always purchase genuine batteries from [Dell Site](#) or authorized Dell partners and resellers.
 - Swollen batteries should not be used and should be replaced and disposed properly. For guidelines on how to handle and replace swollen rechargeable Li-ion batteries, see [Handling swollen rechargeable Li-ion batteries](#).

Removing the battery

-  **CAUTION:** The information in this removal section is intended for authorized service technicians only.

Prerequisites

1. Follow the procedure in [Before working inside your computer](#).
2. Remove the [base cover](#).

About this task

NOTE: This computer is designed without an RTC coin-cell battery. An RTC reset cycle will occur after any of these events:

- After a service incident where the computer battery is disconnected.
- When the battery is fully discharged.
- When the computer is reassembled and turned on again.

When an RTC Reset cycle occurs, the computer turns on and off three times. An "Invalid Configuration" error message is displayed prompting you to enter the BIOS and configure the date and time. The computer functions as per normal after setting the date and time.

NOTE: Removing the battery resets the BIOS setup menu settings to default. It is recommended that you note down the BIOS setup menu settings before removing the battery.

The following image(s) indicate the location of the battery and provides a visual representation of the removal procedure.

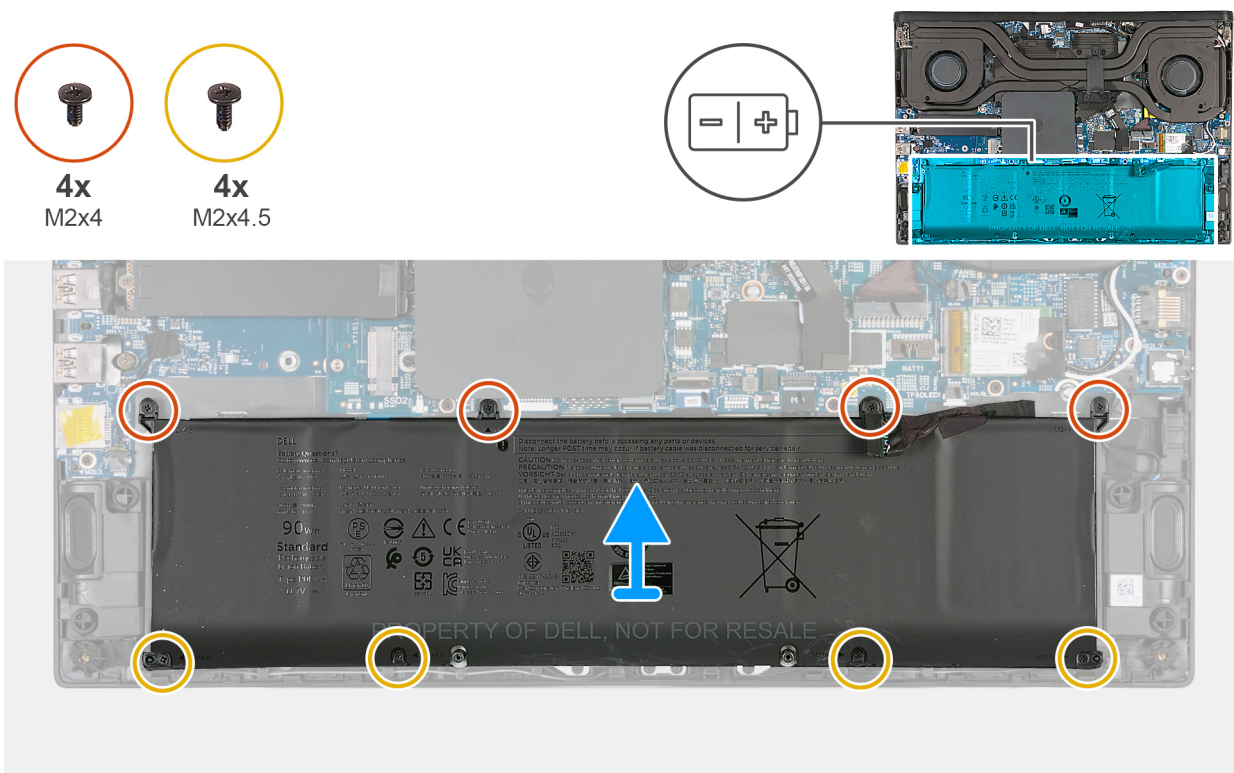

Figure 19. Removing the battery

Steps

1. Remove the four screws (M2x4) that secure the battery to the palm rest and keyboard assembly.
2. Remove the four screws (M2x4.5) that secure the battery to the palm rest and keyboard assembly.
3. Lift the battery off the palm rest and keyboard assembly.

Installing the battery

CAUTION: The information in this installation section is intended for authorized service technicians only.

Prerequisites

If you are replacing a component, remove the existing component before performing the installation process.

About this task

The following image(s) indicate the location of the battery and provides a visual representation of the installation procedure.

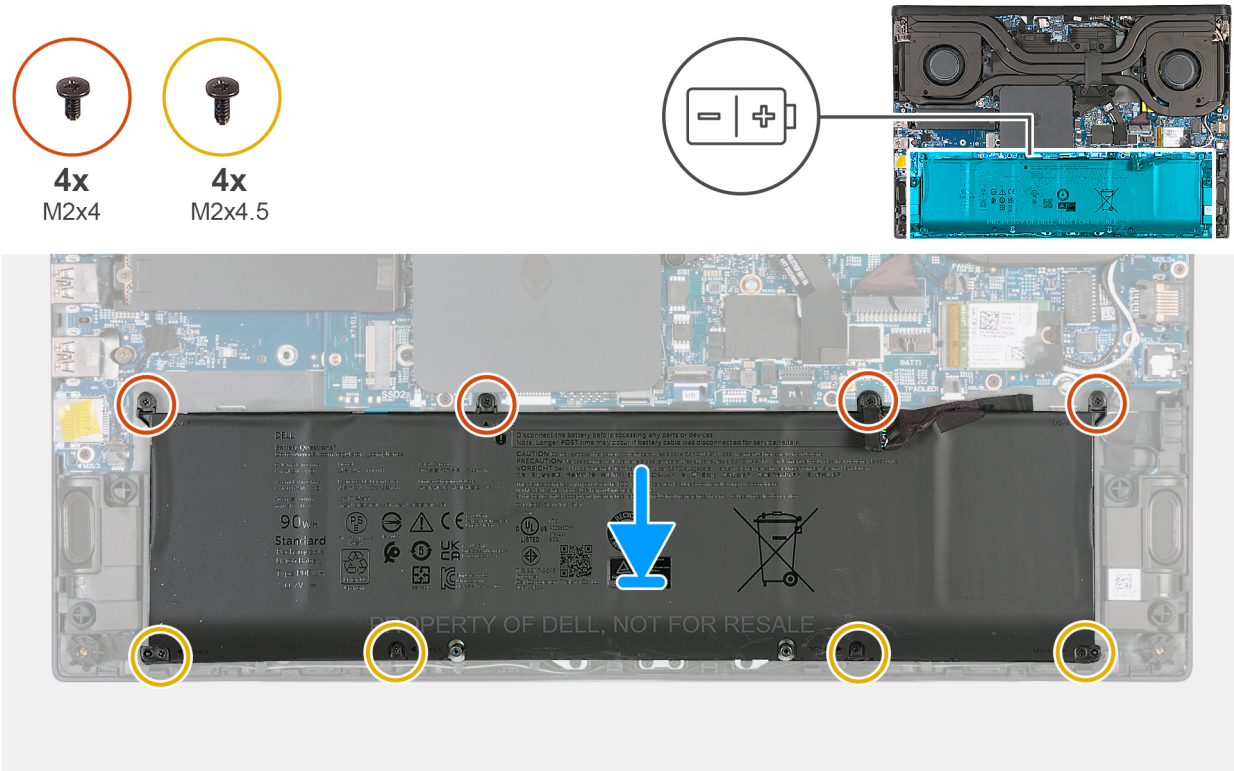

Figure 20. Installing the battery

Steps

1. Using the alignment posts, place the battery on the palm rest and keyboard assembly.
2. Align the screw holes on the battery with the screw holes on the palm rest and keyboard assembly.
3. Replace the four screws (M2x4) that secure the battery to the palm rest and keyboard assembly.
4. Replace the four screws (M2x4.5) that secure the battery to the palm rest and keyboard assembly.

Next steps

1. Install the [base cover](#).
2. Follow the procedure in [After working inside your computer](#).

Battery cable

Removing the battery cable

CAUTION: The information in this removal section is intended for authorized service technicians only.

Prerequisites

1. Follow the procedure in [Before working inside your computer](#).
2. Remove the [base cover](#).
3. Remove the [battery](#).

About this task

NOTE: If the battery is disconnected from the system board for service, then there is a delay during boot as the computer undergoes RTC battery reset.

The following image(s) indicate the location of the battery cable and provides a visual representation of the removal procedure.

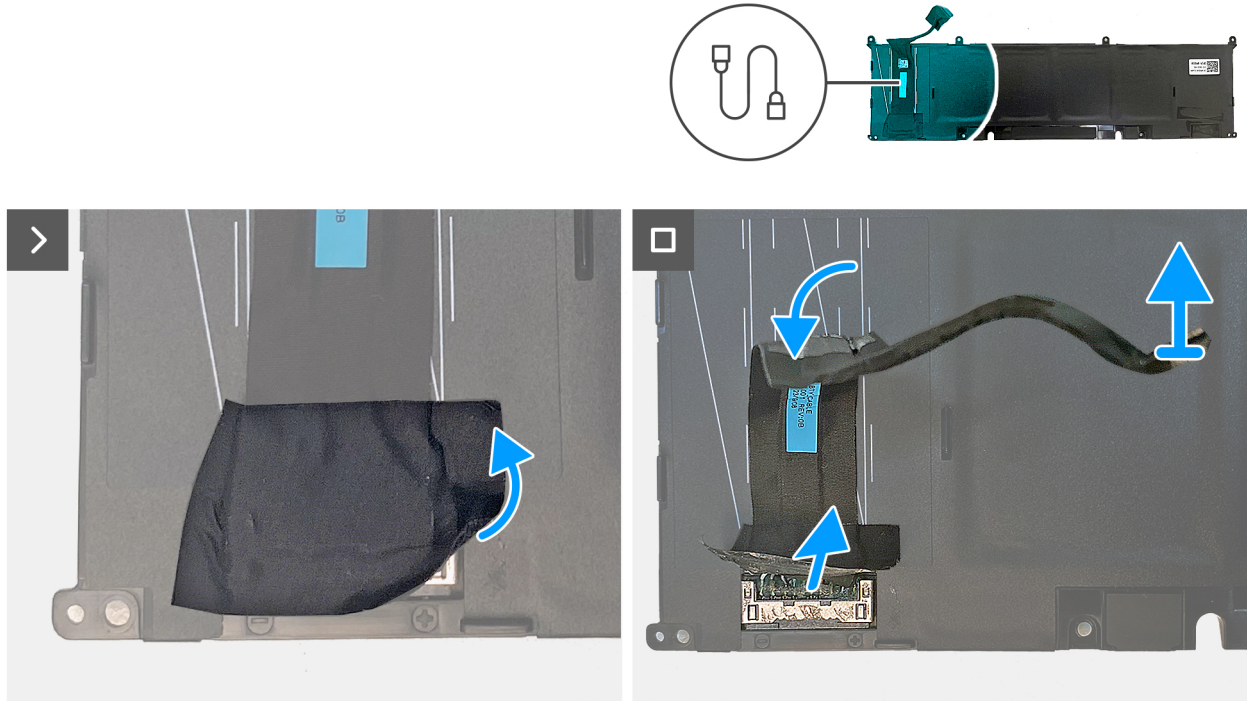

Figure 21. Removing the battery cable

Steps

1. Turn the battery over.
2. Peel the tape to access the battery connector.
3. Peel the battery cable from the battery until you reach the end where it connects the cable to the battery.
4. Grasp the battery cable near the connector and lift to disconnect it from the battery.

Installing the battery cable

CAUTION: The information in this installation section is intended for authorized service technicians only.

Prerequisites

If you are replacing a component, remove the existing component before performing the installation process.

About this task

The following image(s) indicate the location of the battery cable and provides a visual representation of the installation procedure.

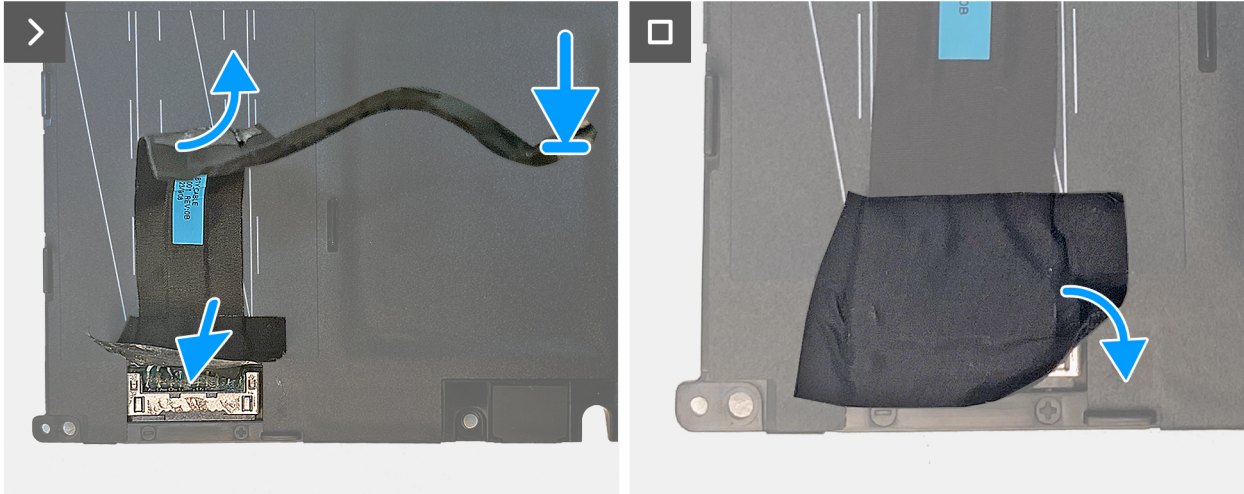
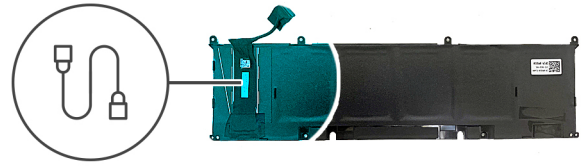

Figure 22. Installing the battery cable

Steps

1. Adhere the battery cable to the battery.
2. Connect the battery cable to the battery.
3. Adhere the tape to secure the battery-cable connector.
4. Turn the battery over.

Next steps

1. Install the [battery](#).
2. Install the [base cover](#).
3. Follow the procedure in [After working inside your computer](#).

Rear I/O cover

Removing the rear I/O cover

⚠ CAUTION: The information in this removal section is intended for authorized service technicians only.

Prerequisites

1. Follow the procedure in [Before working inside your computer](#).
2. Remove the [base cover](#).

About this task

The following image(s) indicate the location of the rear I/O cover and provides a visual representation of the removal procedure.

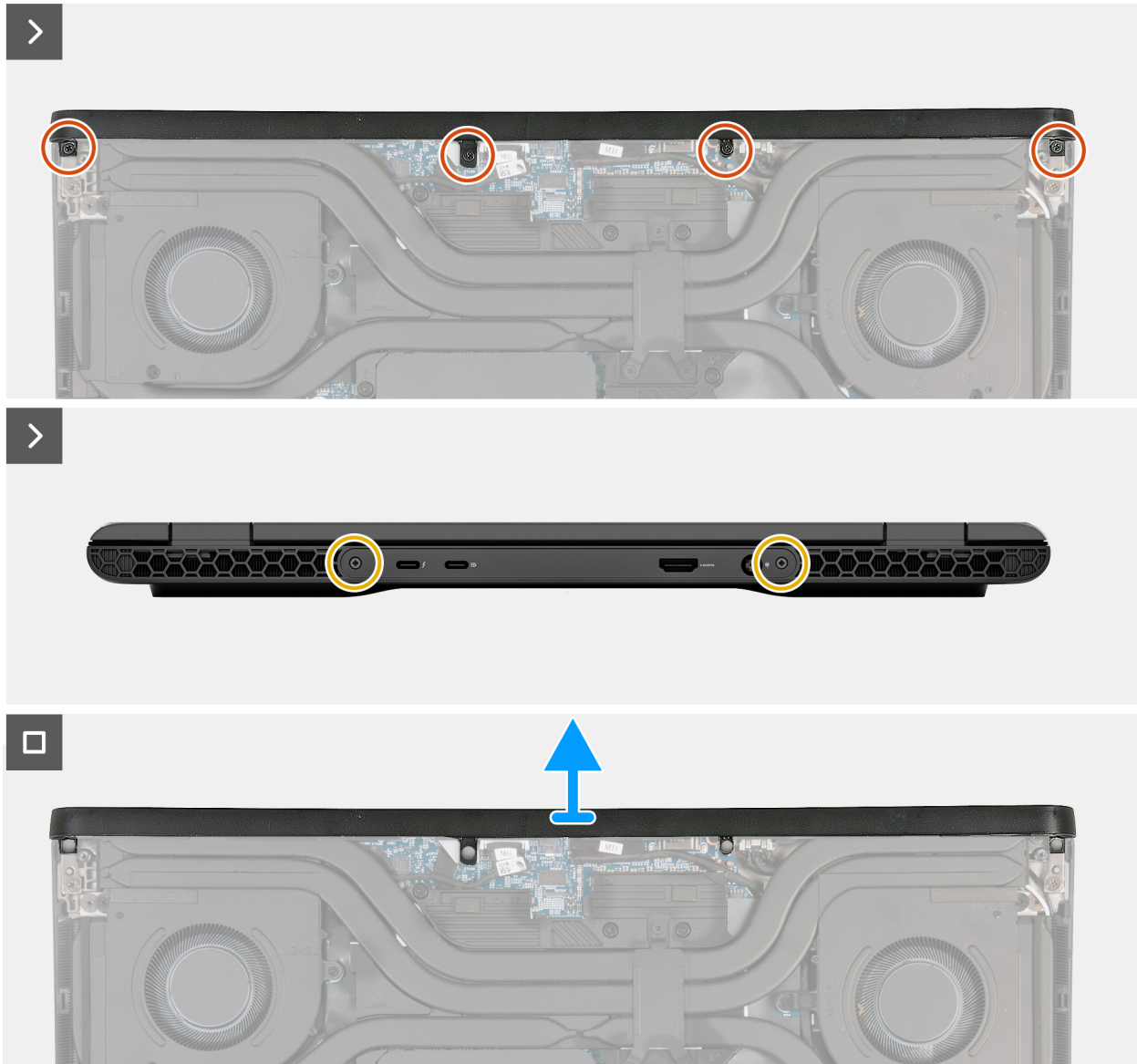
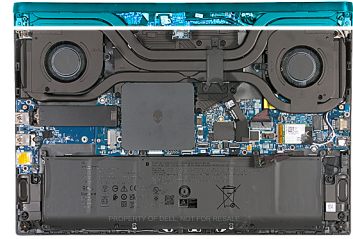

Figure 23. Removing the rear I/O cover

Steps

1. Remove the four screws (M2x5) that secure the rear I/O-cover to the palm rest and keyboard assembly.
2. Remove the two screws (M2x4) that secure the rear I/O cover to the rear of the computer.
3. Starting from the corner, pry the rear I/O cover out and away from the palm rest and keyboard assembly.

Installing the rear I/O cover

 **CAUTION:** The information in this installation section is intended for authorized service technicians only.

Prerequisites

If you are replacing a component, remove the existing component before performing the installation process.

About this task

The following image(s) indicate the location of the rear I/O cover and provides a visual representation of the installation procedure.

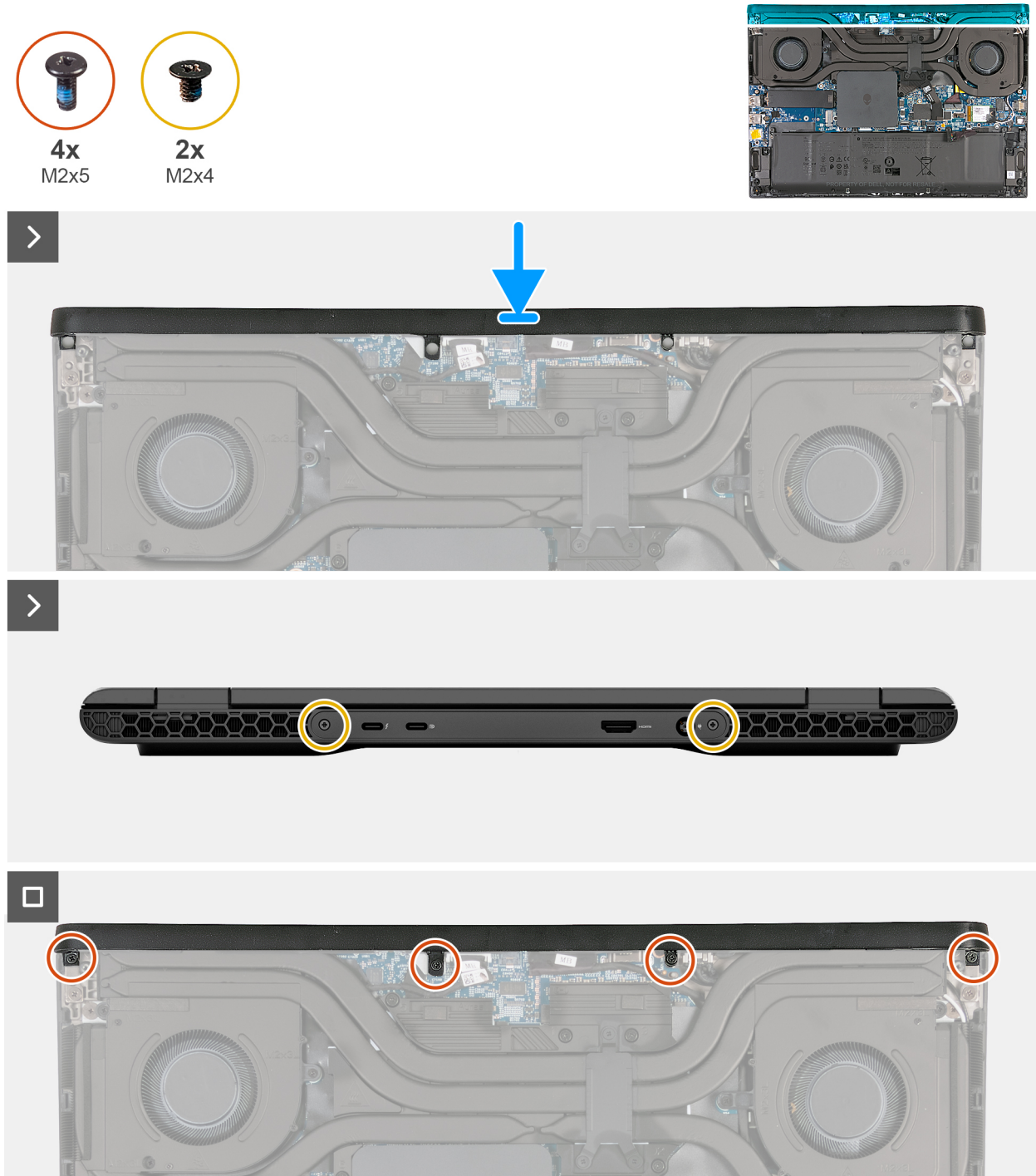

Figure 24. Installing the rear I/O cover

Steps

1. With the correct orientation, slide the rear I/O cover into the palm rest and keyboard assembly, and snap it into place.
2. Replace the two screws (M2x4) that secure the rear I/O cover to the rear of the computer.

3. Replace the four screws (M2x5) that secure the rear I/O cover to the palm rest and keyboard assembly.

Next steps

1. Install the [base cover](#).
2. Follow the procedure in [After working inside your computer](#).

Fan and heat-sink assembly

Removing the fan and heat-sink assembly

 **CAUTION:** The information in this removal section is intended for authorized service technicians only.

Prerequisites

1. Follow the procedure in [Before working inside your computer](#).
2. Remove the [base cover](#).
3. Remove the [rear I/O cover](#).

About this task

 **CAUTION:** The heat sink may become hot during normal operation. Allow sufficient time for the heat sink to cool before you touch it.

 **NOTE:** For maximum cooling of the processor, do not touch the heat transfer areas on the heat sink. The oils in your skin can reduce the heat transfer capability of the thermal grease.

The following image(s) indicate the location of the fan and heat-sink assembly and provides a visual representation of the removal procedure.

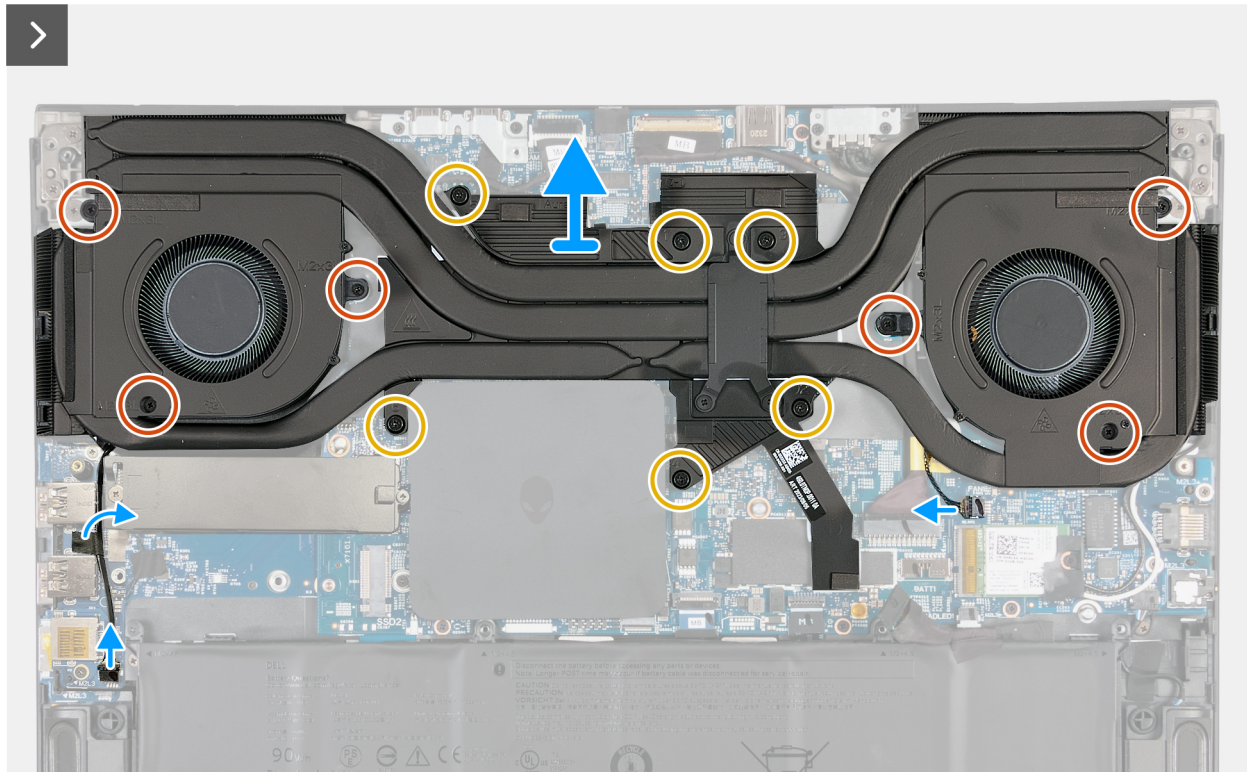

Figure 25. Removing the fan and heat-sink assembly

Steps

1. Disconnect the right fan cable from the connector (FAN1) on the I/O board.
2. Disconnect the left fan cable from the connector (FAN1) on the system board.
3. Peel the tape that secures the fan cable to the I/O board.
4. Remove the six screws (M2x3) that secure the fan and heat-sink assembly to the system board.
5. In reverse sequential order (6>5>4>3>2>1), loosen the six captive screws (M2x7.55) that secure the fan and heat-sink assembly to the system board.
6. Lift the fan and heat-sink assembly off the system board.

Installing the fan and heat-sink assembly

CAUTION: The information in this installation section is intended for authorized service technicians only.

Prerequisites

If you are replacing a component, remove the existing component before performing the installation process.

About this task

The following image(s) indicate the location of the fan and heat-sink assembly and provides a visual representation of the installation procedure.

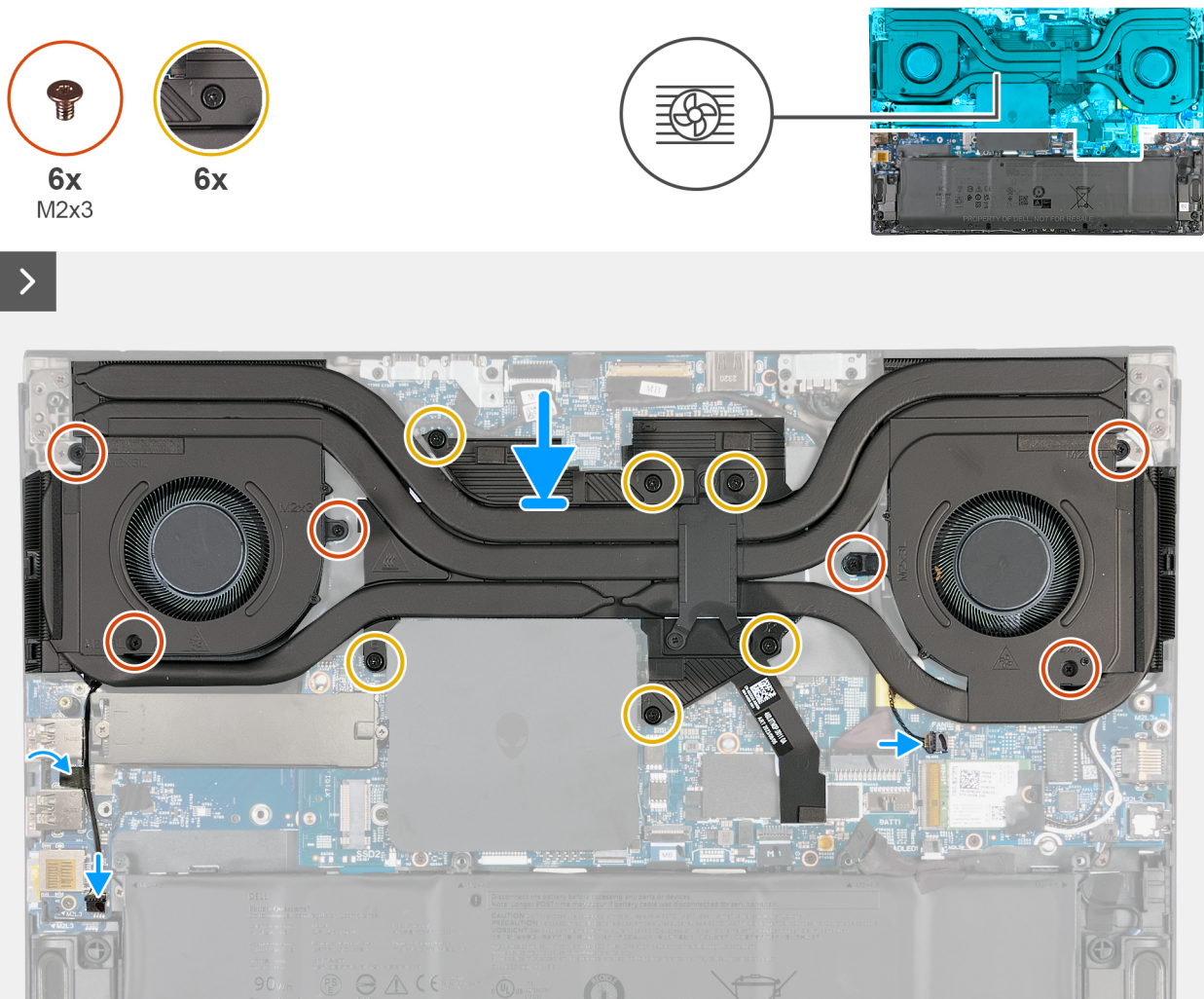

Figure 26. Installing the fan and heat-sink assembly

Steps

1. Align the screw holes on the fan and heat-sink assembly with the screw holes on the system board.
2. In sequential order (1>2>3>4>5>6), tighten the six captive screws (M2x7.55) that secure the fan and heat-sink assembly to the system board.
3. Replace the six screws (M2x3) that secure the fan and heat-sink assembly to the system board.
4. Connect the left fan cable to the connector (FAN1) on the system board.
5. Adhere the tape that secures the fan cable to the I/O board.
6. Connect the right fan cable to the connector (FAN1) on the I/O board.

Next steps

1. Install the [rear I/O cover](#).
2. Install the [base cover](#).
3. Follow the procedure in [After working inside your computer](#).

Speakers

Removing the speakers

CAUTION: The information in this removal section is intended for authorized service technicians only.

Prerequisites

1. Follow the procedure in [Before working inside your computer](#).
2. Remove the [base cover](#).

About this task

The following image(s) indicate the location of the speakers and provides a visual representation of the removal procedure.

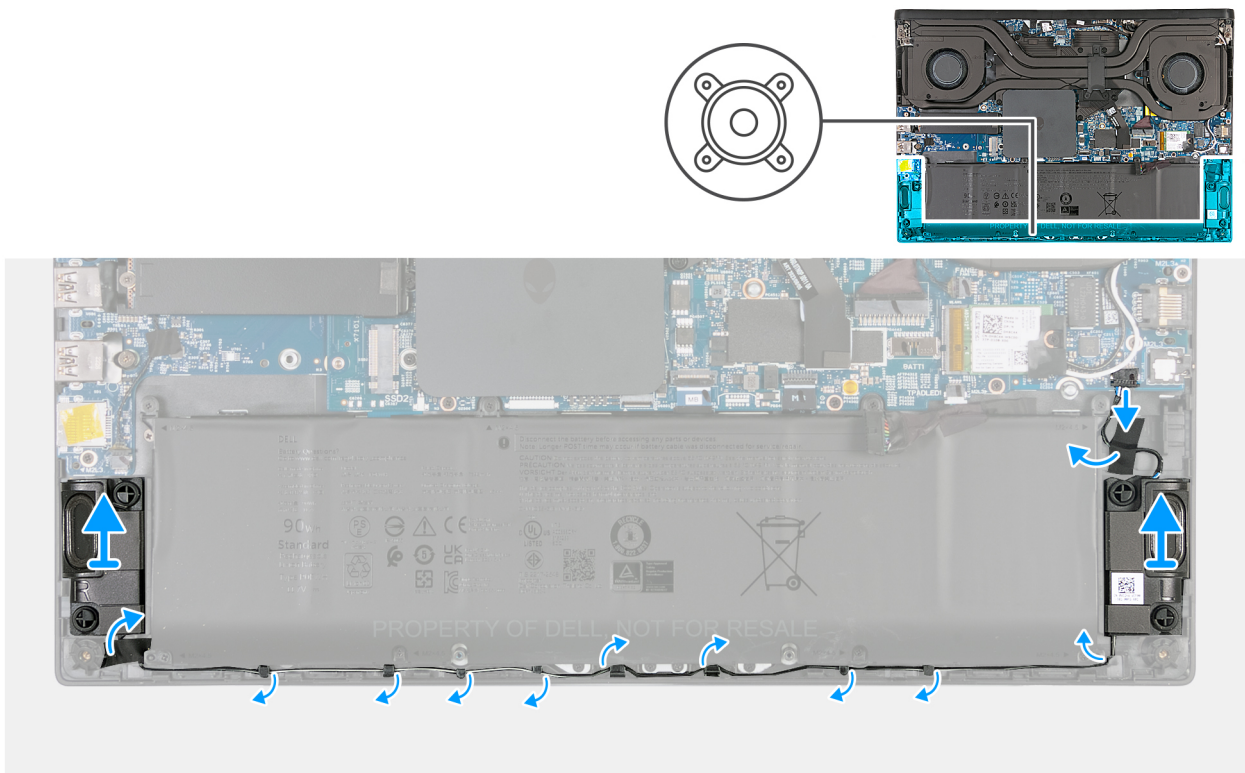

Figure 27. Removing the speakers

Steps

1. Disconnect the speaker cable from the connector (SPK1) on the audio board.
2. Peel the tapes that secure the speaker cable to the palm rest and keyboard assembly.
3. Remove the speaker cable from the routing guides on the palm rest and keyboard assembly.
4. Lift the right and left speaker, along with its cable, off the palm rest and keyboard assembly.

Installing the speakers

CAUTION: The information in this installation section is intended for authorized service technicians only.

Prerequisites

If you are replacing a component, remove the existing component before performing the installation process.

About this task

The following image(s) indicate the location of the speakers and provides a visual representation of the installation procedure.

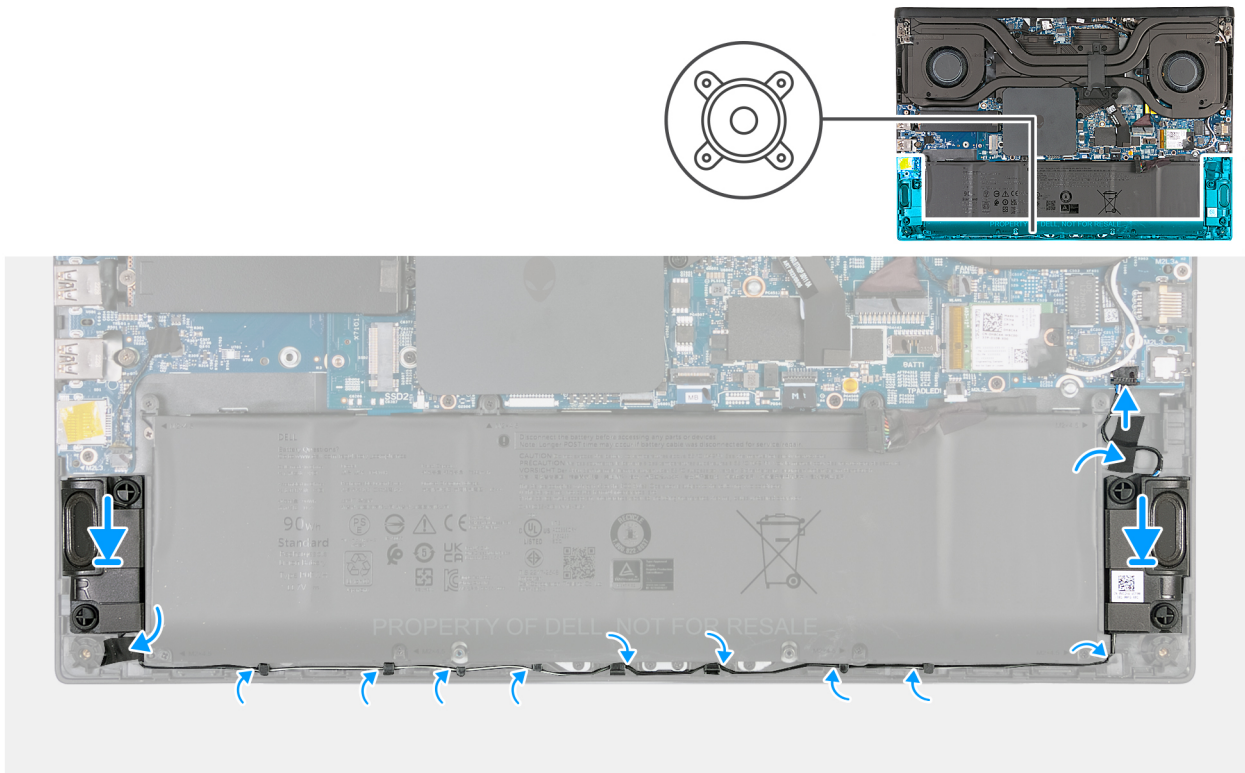

Figure 28. Installing the speakers

Steps

1. Using the alignment posts, place the left and right speakers into their slots on the palm rest and keyboard assembly.
NOTE: Ensure that the alignment posts are threaded through the rubber grommets on the speaker.
2. Route the speaker cable through the routing guides on the palm rest and keyboard assembly.
3. Adhere the tapes that secure the speaker cable to the palm rest and keyboard assembly.
4. Connect the speaker cable to connector (SPK1) on the audio board.

Next steps

1. Install the [base cover](#).
2. Follow the procedure in [After working inside your computer](#).

Power-adapter port

Removing the power-adapter port

CAUTION: The information in this removal section is intended for authorized service technicians only.

Prerequisites

1. Follow the procedure in [Before working inside your computer](#).
2. Remove the [base cover](#).
3. Remove the [rear I/O cover](#).
4. Remove the [fan and heat-sink assembly](#).

About this task

The following image(s) indicate the location of the power-adapter port and provides a visual representation of the removal procedure.

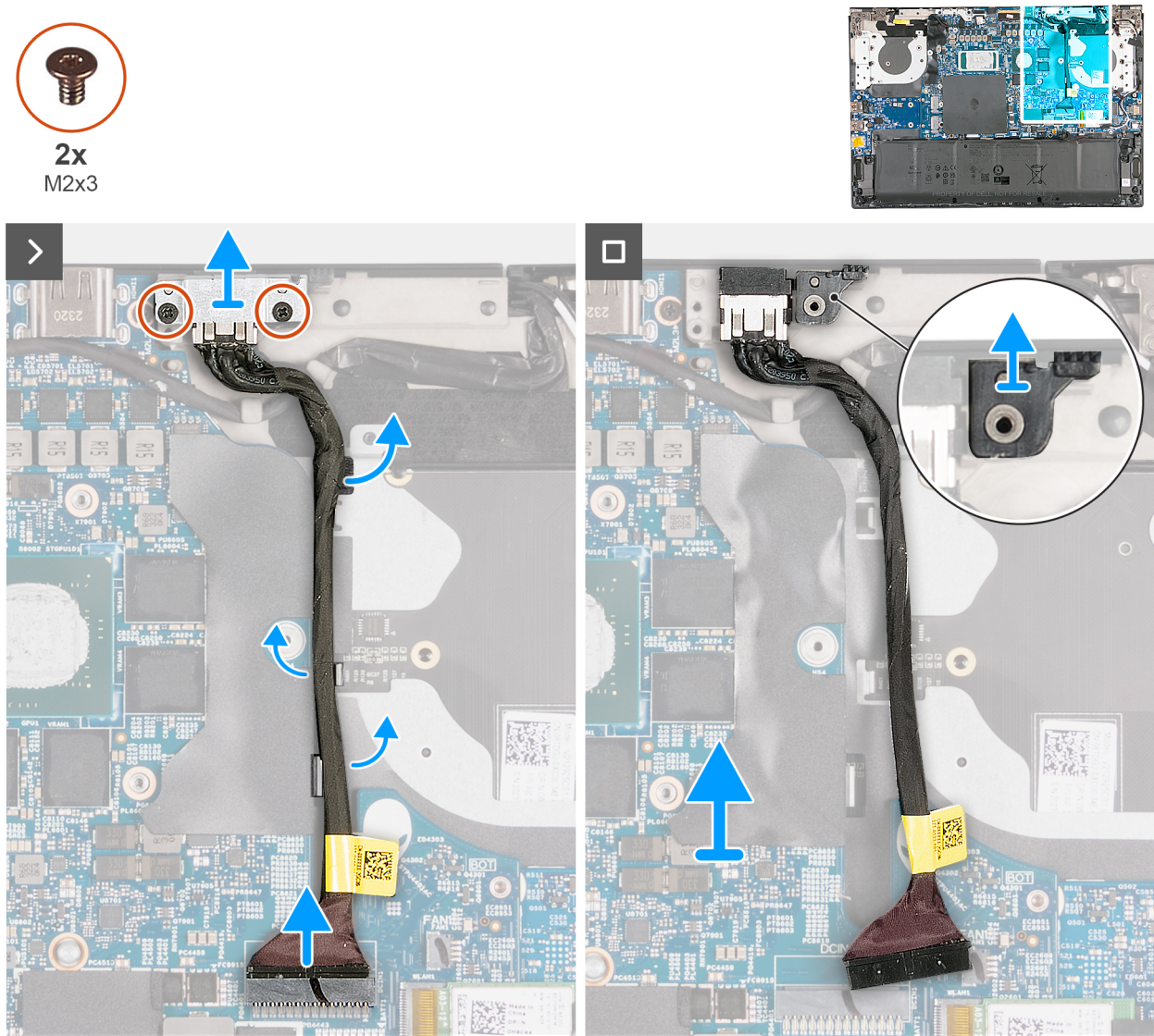

Figure 29. Removing the power-adapter port

Steps

1. Remove the two screws (M2x3) that secure the power-adapter port bracket to the palm rest and keyboard assembly.
2. Lift the power-adapter port bracket off the palm rest and keyboard assembly.
3. Remove the thermal filler from the slot on the palm rest and keyboard assembly and keep it aside.
4. Peel off the tapes that secure the power-adapter port cable to the palm rest and keyboard assembly.
5. Disconnect the power-adapter port cable from the connector (DCIN1) on the system board.
6. Lift the power-adapter port along with its cable from the palm rest and keyboard assembly.

Installing the power-adapter port

CAUTION: The information in this installation section is intended for authorized service technicians only.

Prerequisites

If you are replacing a component, remove the existing component before performing the installation process.

About this task

The following image(s) indicate the location of the power-adapter port and provides a visual representation of the installation procedure.

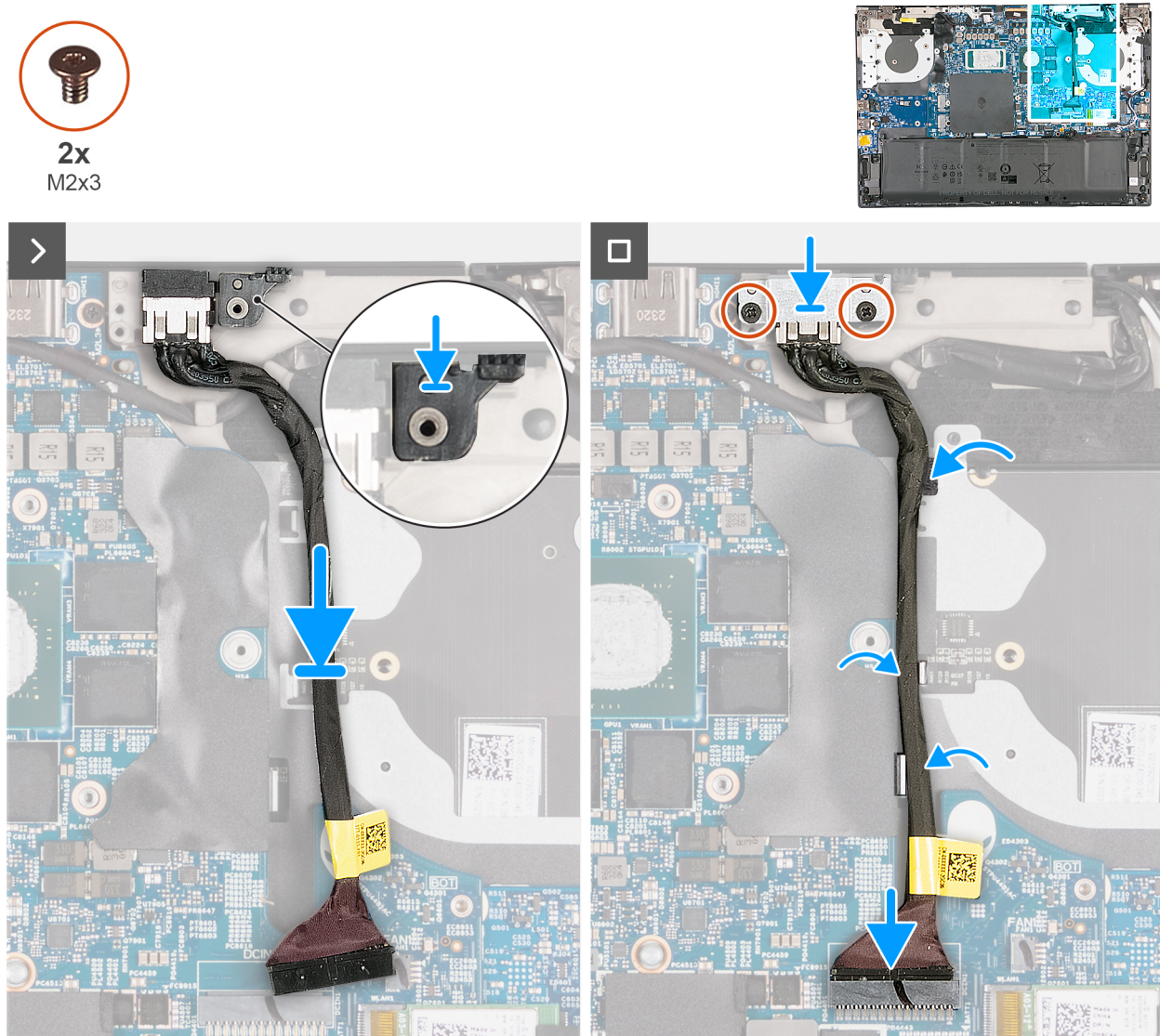

Figure 30. Installing the power-adapter port

Steps

1. Place the power-adapter port into the slot on the palm rest and keyboard assembly.
2. Using the alignment post, place the thermal filler into the slot on the palm rest and keyboard assembly.
3. Place the power-adapter port bracket on the power-adapter port.
4. Align the screw holes on the power-adapter port bracket with the screw holes on the palm rest and keyboard assembly.
5. Replace the two screws (M2x3) that secure the power-adapter port bracket to the palm rest and keyboard assembly.
6. Adhere the tapes that secure the power-adapter port to the palm rest and keyboard assembly.
7. Connect the power-adapter port cable to the connector (DCIN1) on the system board.

Next steps

1. Install the [fan and heat-sink assembly](#).
2. Install the [rear I/O cover](#).
3. Install the [base cover](#).
4. Follow the procedure in [After working inside your computer](#).

Touchpad

Removing the touchpad

 **CAUTION:** The information in this removal section is intended for authorized service technicians only.

Prerequisites

1. Follow the procedure in [Before working inside your computer](#).
2. Remove the [base cover](#).
3. Remove the [battery](#).

About this task

The following image(s) indicate the location of the touchpad and provides a visual representation of the removal procedure.

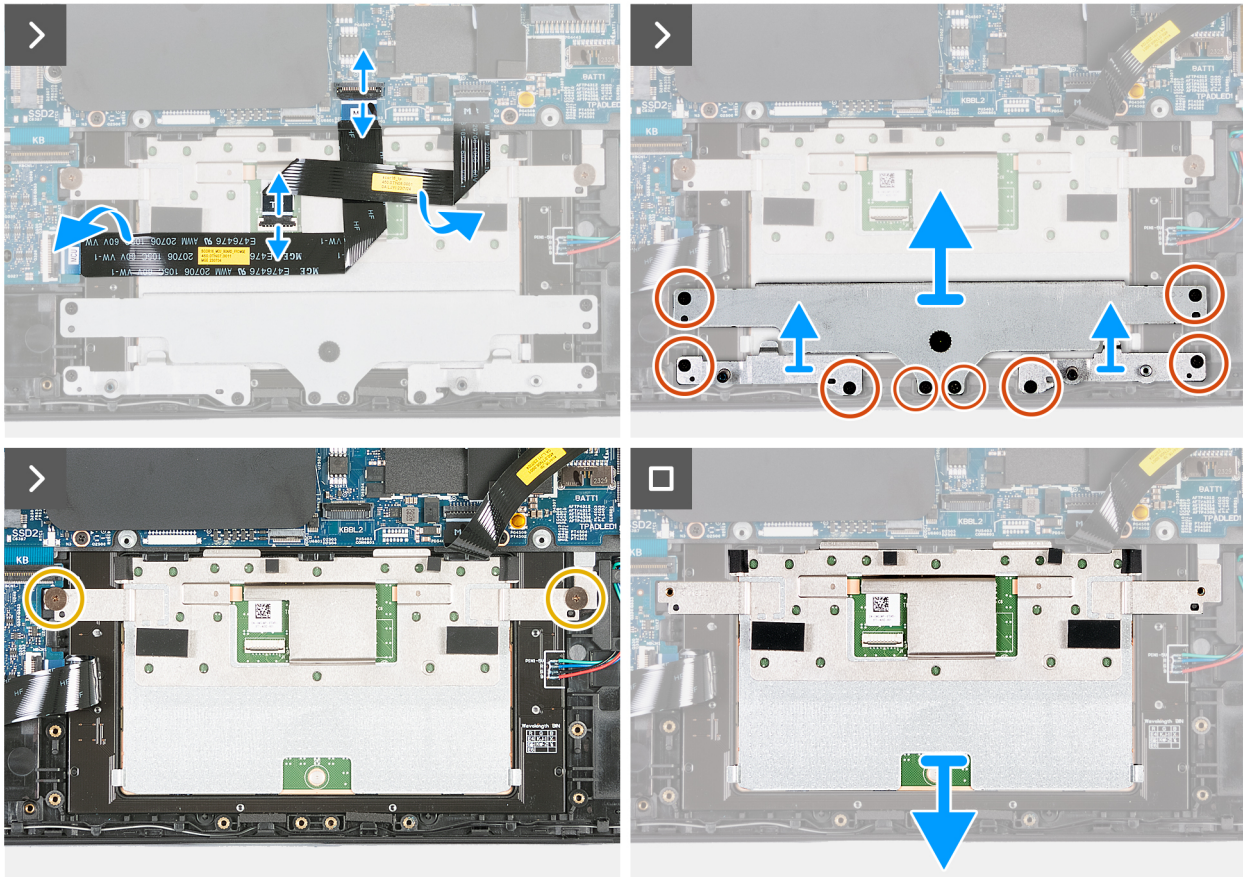
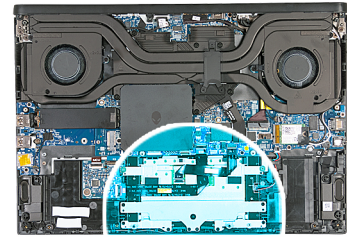
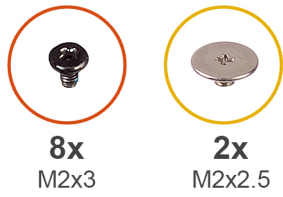

Figure 31. Removing the touchpad

Steps

1. Open the latch and disconnect the main-control unit (MCU) cable from the connector (KBBL2) on the system board.
2. Open the latch and disconnect the touchpad cable from the touchpad.
3. Remove the four screws (M2x3) that secure the touchpad dome bracket to the palm rest and keyboard assembly.
4. Remove the four screws (M2x3) that secure the touchpad brackets to the palm rest and keyboard assembly.
5. Lift the touchpad dome bracket and two touchpad brackets off the palm rest and keyboard assembly.
6. Remove the two screws (M2x2.5) that secure the touchpad to the palm rest and keyboard assembly.
7. Lift the touchpad from the palm rest and keyboard assembly.

Installing the touchpad

CAUTION: The information in this installation section is intended for authorized service technicians only.

Prerequisites

If you are replacing a component, remove the existing component before performing the installation process.

About this task

The following image(s) indicate the location of the touchpad and provides a visual representation of the installation procedure.

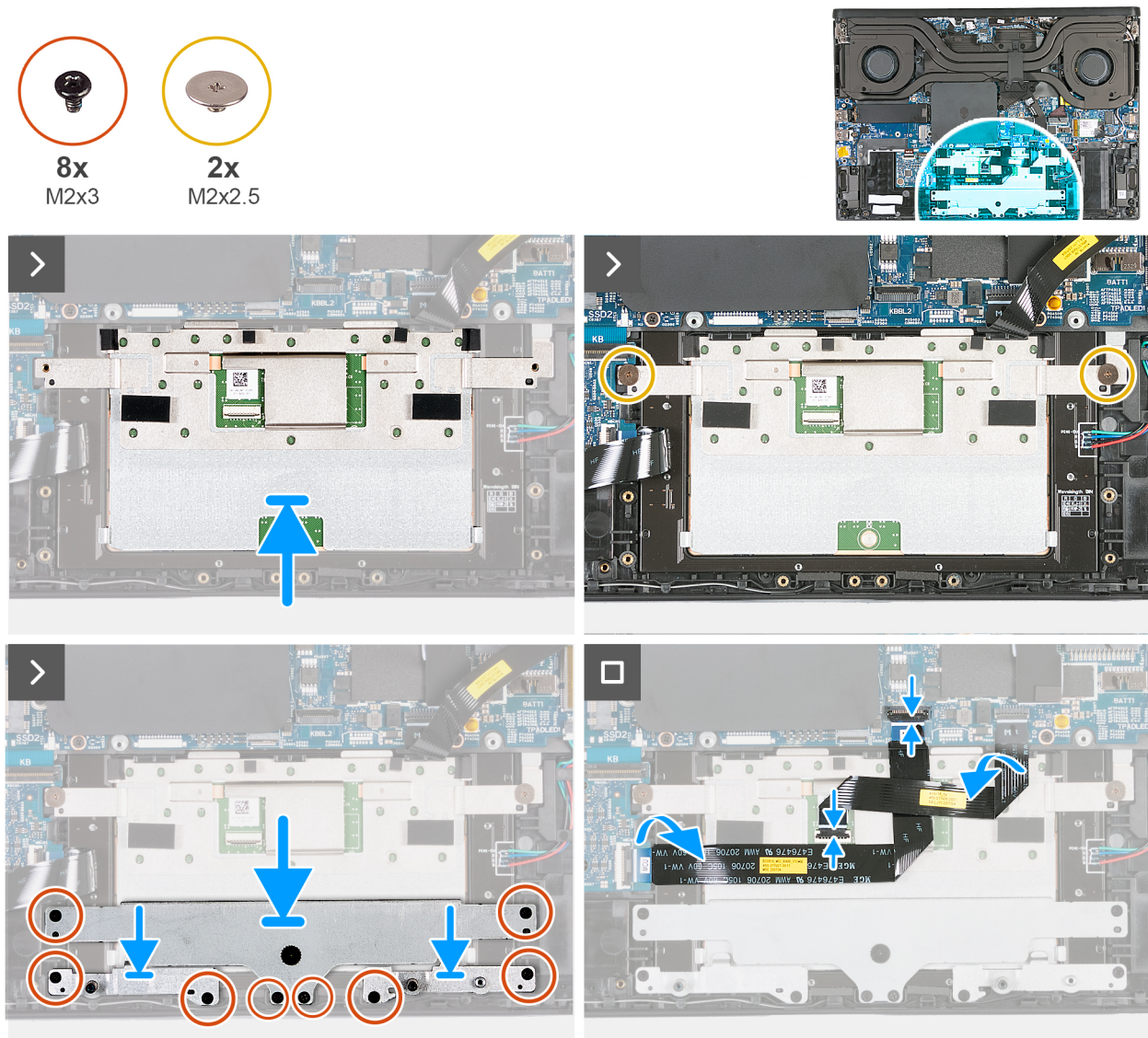
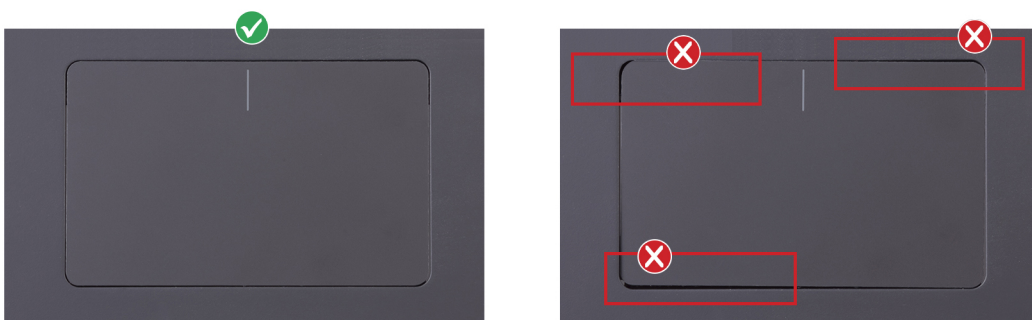

Figure 32. Installing the touchpad

Steps

1. At an angle slide the touchpad into the slot on the palm rest and keyboard assembly.
2. Turn the computer over and open the display to ensure that the touchpad is equally aligned on all sides.

NOTE: The image below shows the proper touchpad alignment for your computer.



3. Close the display and turn the computer over.
4. Replace the two screws (M2x2.5) that secure the touchpad to the palm rest and keyboard assembly.
5. Align the screw holes on the touchpad brackets with the screw holes on the palm rest and keyboard assembly.
6. Replace the four screws (M2x3) that secure the touchpad brackets to the palm rest and keyboard assembly.
7. Align the screw holes on the touchpad dome bracket with the screw holes on the palm rest and keyboard assembly.
8. Replace the four screws (M2x3) that secure the touchpad dome bracket to the palm rest and keyboard assembly.
9. Connect the touchpad cable to the touchpad and close the latch to secure the cable.
10. Connect the main-control unit (MCU) cable to the connector (KBBL2) on the system board and close the latch to secure the connector.

Next steps

1. Install the [battery](#).
2. Install the [base cover](#).
3. Follow the procedure in [After working inside your computer](#).

Keyboard-controller board

Removing the keyboard-controller board

 **CAUTION:** The information in this removal section is intended for authorized service technicians only.

Prerequisites

1. Follow the procedure in [Before working inside your computer](#).
2. Remove the [base cover](#).
3. Remove the [battery](#).

About this task

The following image(s) indicate the location of the keyboard-controller board and provides a visual representation of the removal procedure.

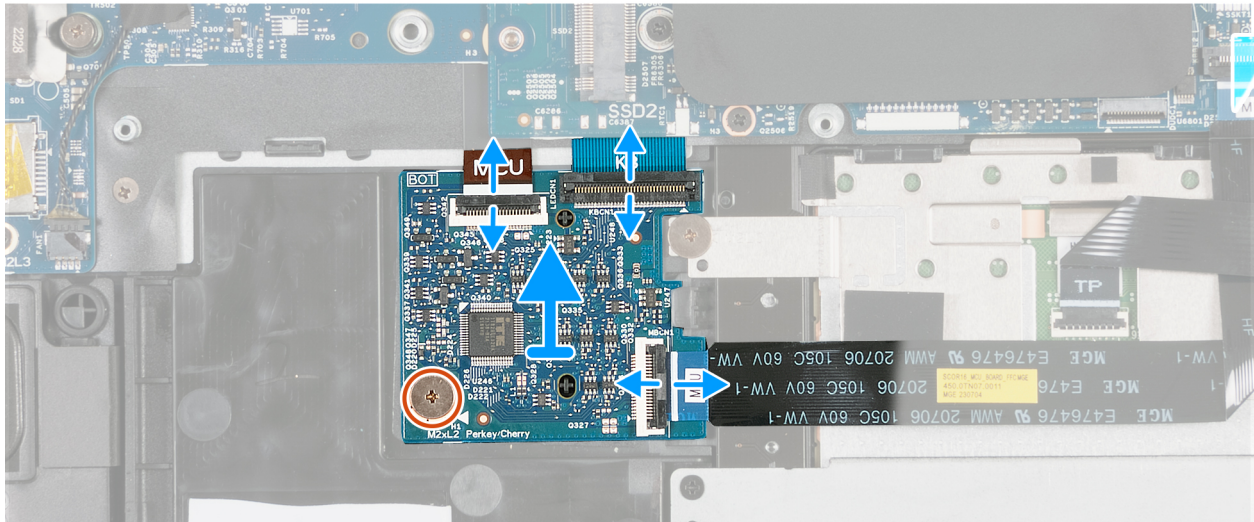
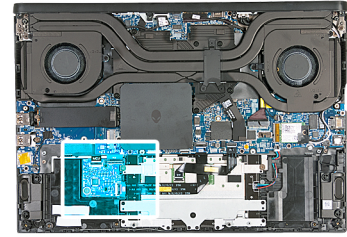

Figure 33. Removing the keyboard-controller board

Steps

1. Open the latch and disconnect the keyboard-backlight cable from the connector (LEDCN1) on the keyboard-controller board.
2. Open the latch and disconnect the keyboard cable from the connector (KBCN1) on the keyboard-controller board.
3. Open the latch and disconnect the keyboard-controller board cable from the connector (MBCN1) on the keyboard-controller board.
4. Remove the screw (M2x2.5) that secures the keyboard-controller board to the palm rest and keyboard assembly.
5. Lift the keyboard-controller board off the palm-rest and keyboard assembly.

Installing the keyboard-controller board

 **CAUTION:** The information in this installation section is intended for authorized service technicians only.

Prerequisites

If you are replacing a component, remove the existing component before performing the installation process.

About this task

The following image(s) indicate the location of the keyboard-controller board and provides a visual representation of the installation procedure.

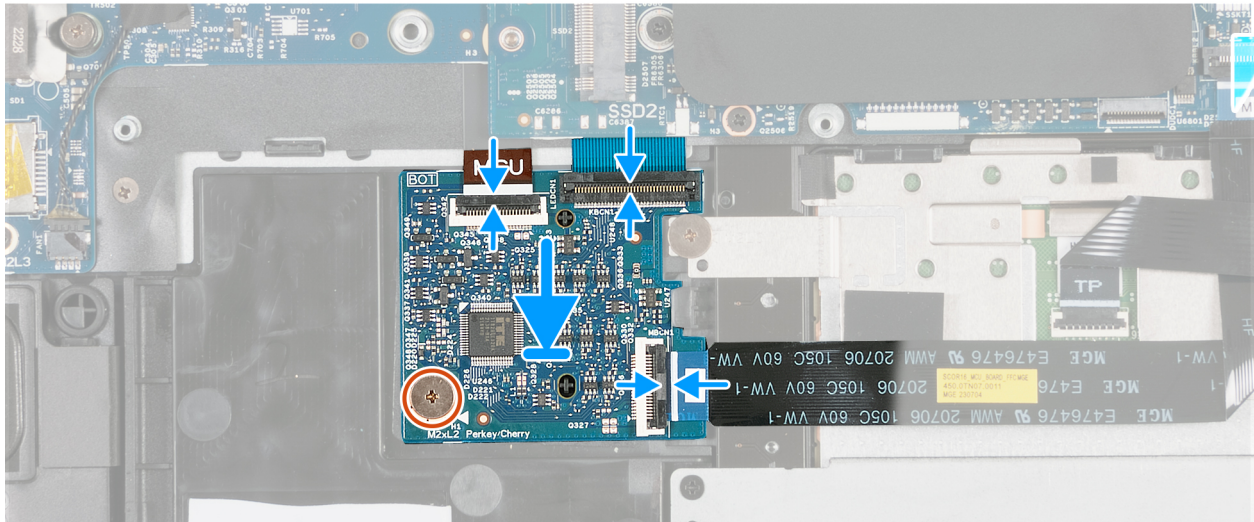
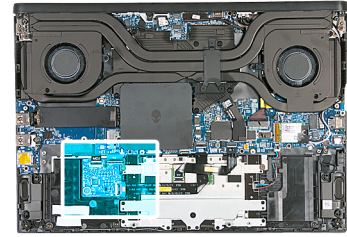

Figure 34. Installing the keyboard-controller board

Steps

1. Using the alignment posts, place the keyboard-controller board into the slot on the palm rest and keyboard assembly.
2. Replace the screw (M2x2.5) that secures the keyboard-controller board to the palm rest and keyboard assembly.
3. Connect the keyboard-backlight cable to the connector (LEDCN1) on the keyboard-controller board and close the latch to secure the cable.
4. Connect the keyboard cable to the connector (MBCN1) on the keyboard-controller board and close the latch to secure the cable.
5. Connect the keyboard-controller board cable to the system board and close the latch to secure the cable.

Next steps

1. Install the [battery](#).
2. Install the [base cover](#).
3. Follow the procedure in [After working inside your computer](#).

Display-hinge covers

Removing the display-hinge covers

 **CAUTION:** The information in this removal section is intended for authorized service technicians only.

Prerequisites

1. Follow the procedure in [Before working inside your computer](#).
2. Remove the [base cover](#).
3. Remove the [rear I/O cover](#).

About this task

The following image(s) indicate the location of the display-hinge covers and provides a visual representation of the removal procedure.

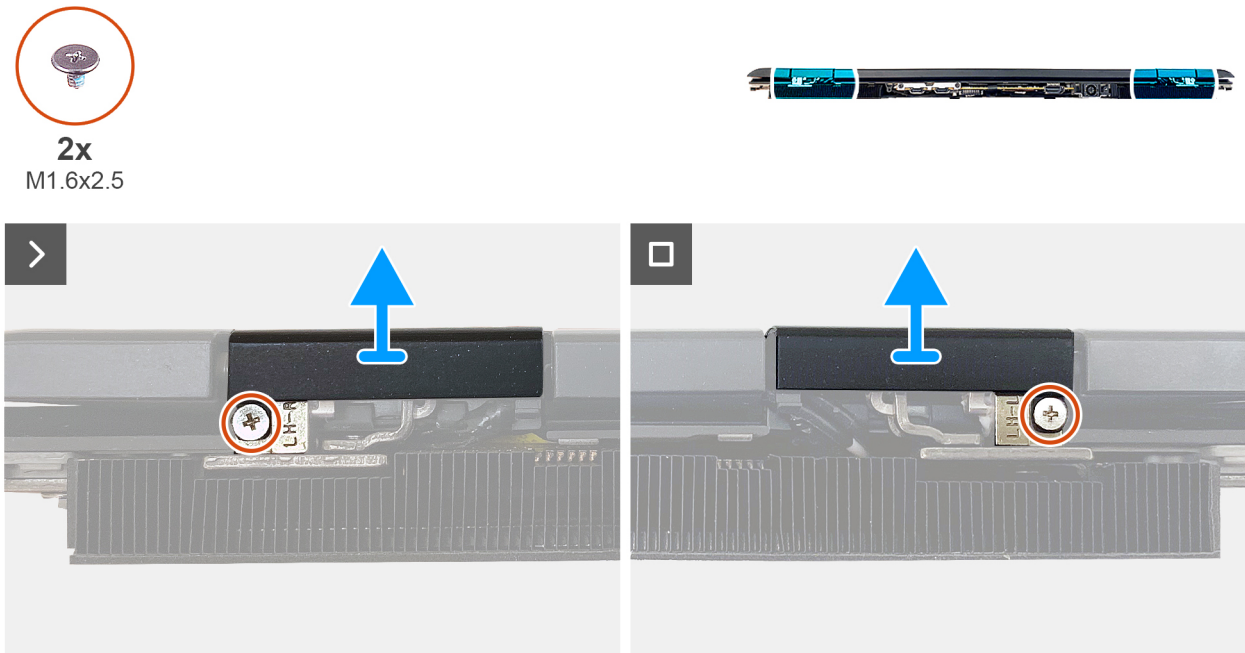

Figure 35. Removing the display-hinge cover

Steps

1. Close the display and remove the screw (M1.6x2.5) that secures the right display-hinge cover (R) to the right hinge.
2. Remove the screw (M1.6x2.5) that secures the left display-hinge cover (L) to the left hinge.
3. Gently pry out both display-hinge covers from the display hinges.

Installing the display-hinge covers

CAUTION: The information in this installation section is intended for authorized service technicians only.

Prerequisites

If you are replacing a component, remove the existing component before performing the installation process.

About this task

The following image(s) indicate the location of the display-hinge covers and provides a visual representation of the installation procedure.



2x
M1.6x2.5

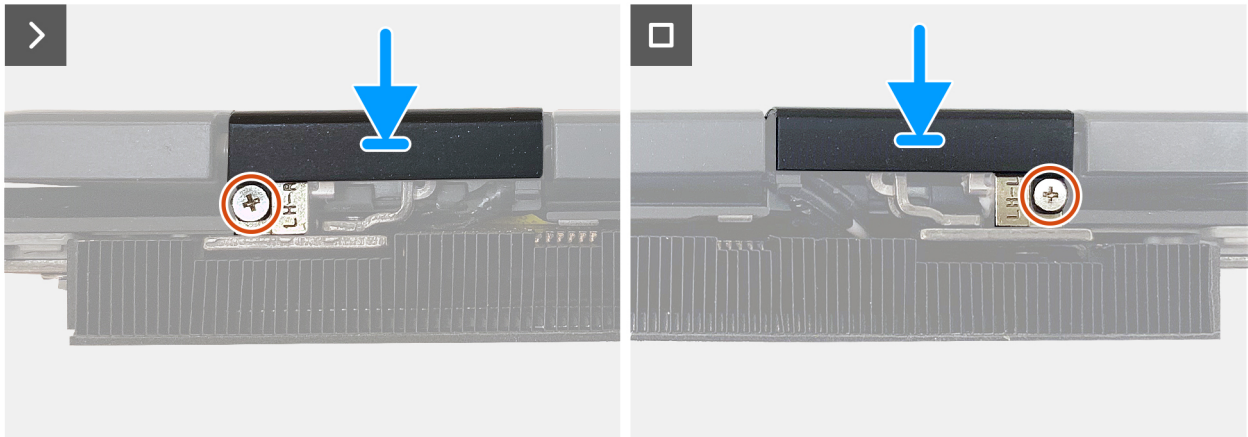

Figure 36. Installing the display-hinge covers

Steps

1. With the display closed, align and place the left hinge cover (L) on the left hinge.
2. Align the screw hole on the left display-hinge cover (L) with the screw hole on the left hinge.
3. Replace the screw (M1.6x2.5) that secures the left display-hinge cover (L) to the left hinge.
4. Align and place the right display-hinge cover (R) on the right hinge.
5. Align the screw hole on the right display-hinge cover (R) with the screw hole on the right hinge.
6. Replace the screw (M1.6x2.5) that secures the right display-hinge cover (R) to the right hinge.

Next steps

1. Install the [rear I/O cover](#).
2. Install the [base cover](#).
3. Follow the procedure in [After working inside your computer](#).

Display assembly

Removing the display assembly

CAUTION: The information in this removal section is intended for authorized service technicians only.

Prerequisites

1. Follow the procedure in [Before working inside your computer](#).
2. Remove the [base cover](#).
3. Remove the [rear I/O cover](#).
4. Remove the [display-hinge covers](#).
5. Remove the [fan and heat-sink assembly](#).
6. Remove the [wireless card](#).

About this task

The following image(s) indicate the location of the display assembly and provides a visual representation of the removal procedure.

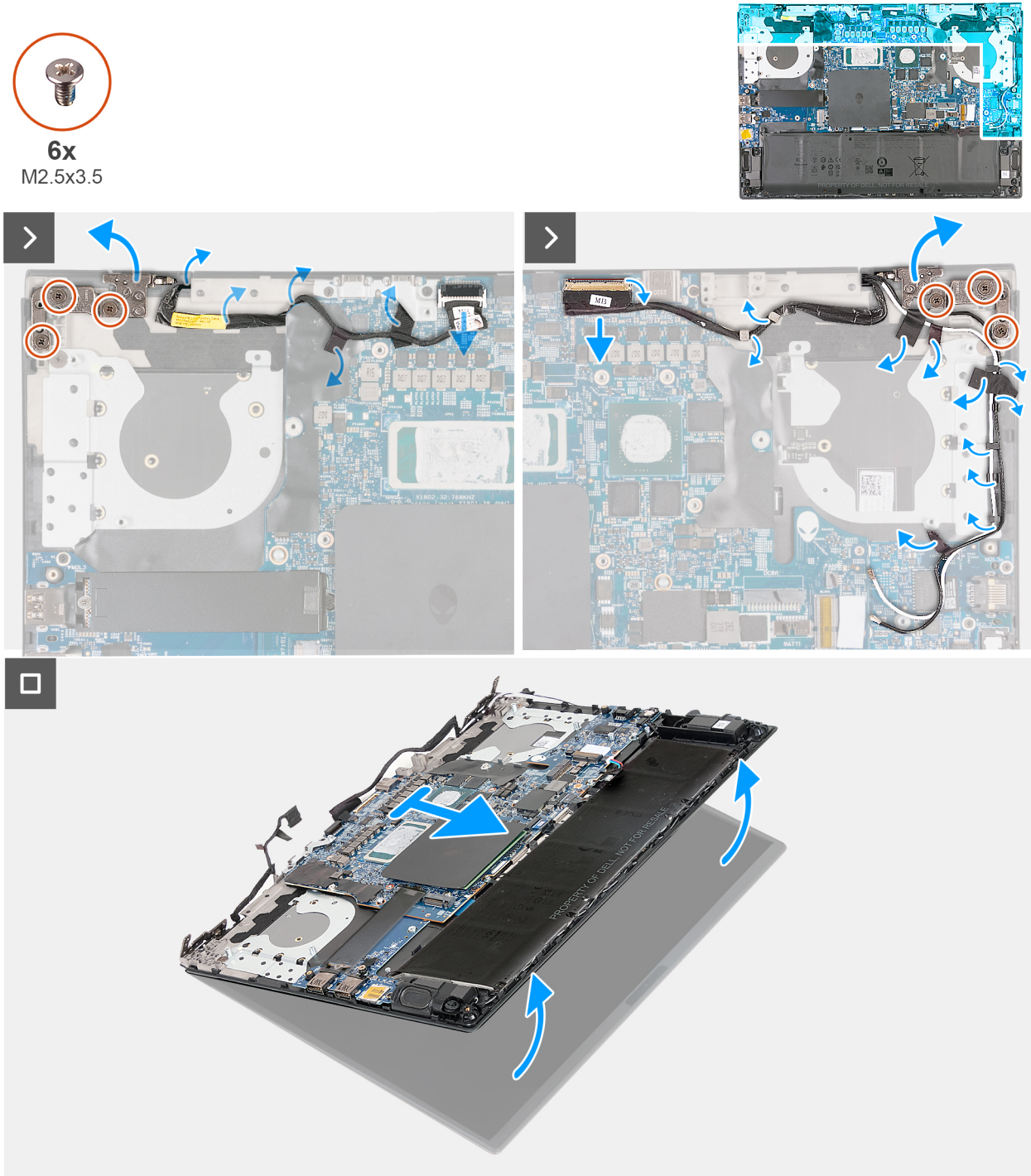

Figure 37. Removing the display assembly

Steps

1. Disconnect the camera cable from the connector (CAM1) on the system board.
2. Peel the tapes that secure the camera cable to the palm rest and keyboard assembly.
3. Peel the camera cable from the palm rest and keyboard assembly.
4. Remove the three screws (M2.5x3.5) that secure the right hinge to the palm rest and keyboard assembly and open the hinge.

5. Open the latch and disconnect the display cable from the connector (LCD1) on the system board.
6. Peel the tapes that secure the display cable to the palm rest and keyboard assembly.
7. Remove the display cable from the routing guides on the palm rest and keyboard assembly.
8. Peel the tapes and remove the antenna cables from the routing guides on the palm rest and keyboard assembly.
9. Remove the three screws (M2.5x3.5) that secure the left hinge to the palm rest and keyboard assembly and open the hinge.
10. Open the palm rest and keyboard assembly at an angle and remove the display assembly.

Installing the display assembly

 **CAUTION:** The information in this installation section is intended for authorized service technicians only.

Prerequisites

If you are replacing a component, remove the existing component before performing the installation process.

About this task

The following image(s) indicate the location of the display assembly and provides a visual representation of the installation procedure.



6x
M2.5x3.5

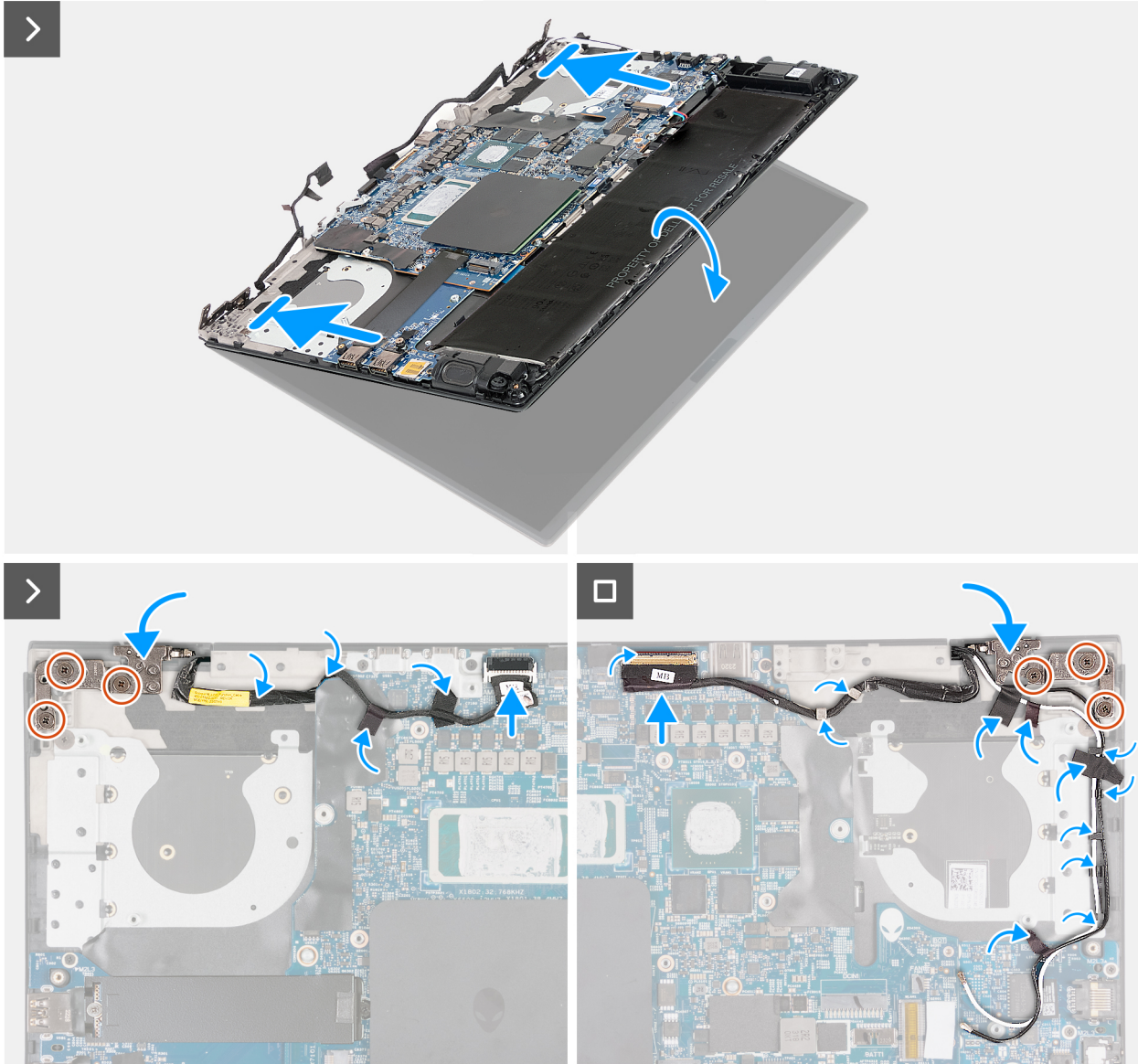
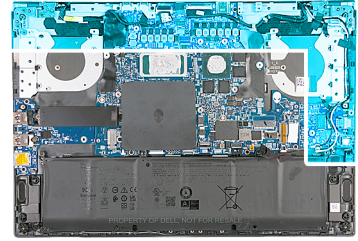

Figure 38. Installing the display assembly

Steps

1. Place the palm rest and keyboard assembly on the display assembly.

 **CAUTION:** To avoid damaging the display, do not slide palm rest and keyboard assembly on the display assembly.

2. Align the screw holes on the display hinges with the screw holes on the palm rest and keyboard assembly and close the display hinges.
3. Replace the six screws (M2.5x3.5) that secure the display hinges to the palm rest and keyboard assembly.
4. Adhere the tape that secures the camera cable to the palm rest and keyboard assembly.

5. Adhere the camera cable to the palm rest and keyboard assembly.
6. Connect the camera cable to the connector (CAM1) on the system board.
7. Connect the display cable to the connector (LCD1) on the system board and close the latch to secure the cable.

Next steps

1. Install the [wireless card](#).
2. Install the [fan and heat-sink assembly](#).
3. Install the [display-hinge covers](#).
4. Install the [rear I/O cover](#).
5. Install the [base cover](#).
6. Follow the procedure in [After working inside your computer](#).

Type-C bracket

Removing the Type-C bracket

CAUTION: The information in this removal section is intended for authorized service technicians only.

Prerequisites

1. Follow the procedure in [Before working inside your computer](#).
2. Remove the [base cover](#).
3. Remove the [rear I/O cover](#).

About this task

The following image(s) indicate the location of the Type-C bracket and provides a visual representation of the removal procedure.

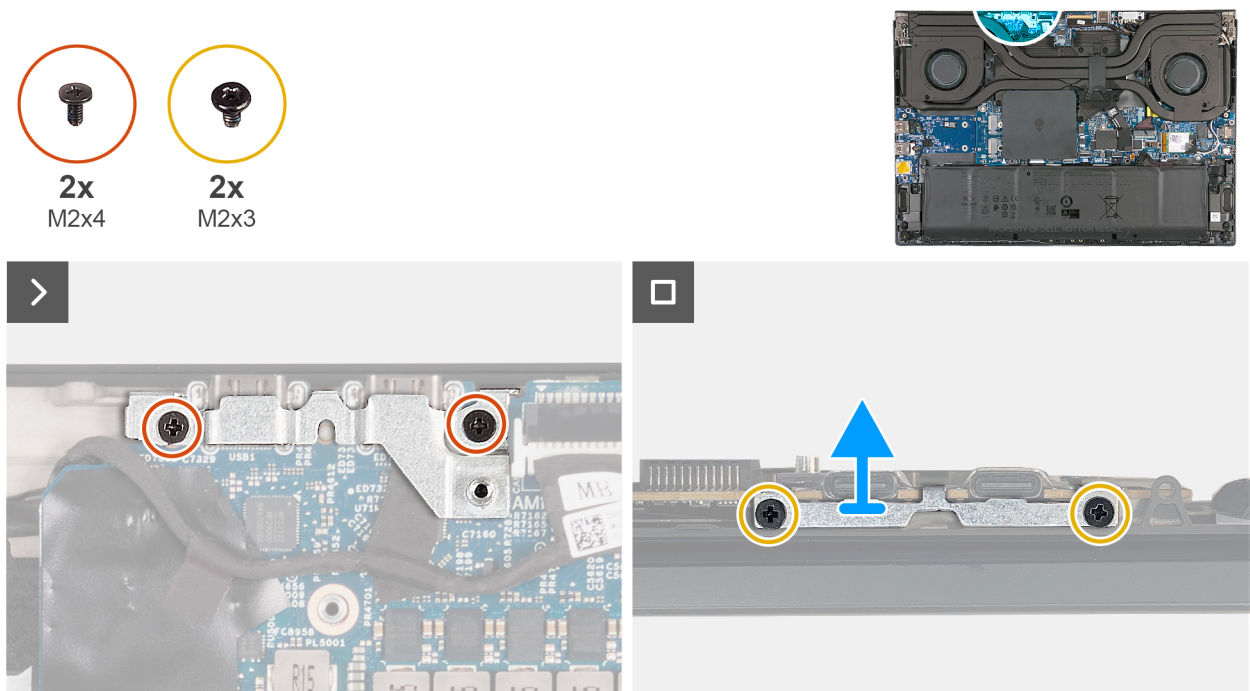

Figure 39. Removing the Type-C bracket

Steps

1. Remove the two screws (M2x4) that secure the Type-C bracket to the system board.

2. Remove the two screws (M2x3) that secure the Type-C bracket to the palm rest and keyboard assembly.
3. Lift the Type-C bracket from the palm rest and keyboard assembly.

Installing the Type-C bracket

CAUTION: The information in this installation section is intended for authorized service technicians only.

Prerequisites

If you are replacing a component, remove the existing component before performing the installation process.

About this task

The following image(s) indicate the location of the Type-C bracket and provides a visual representation of the installation procedure.

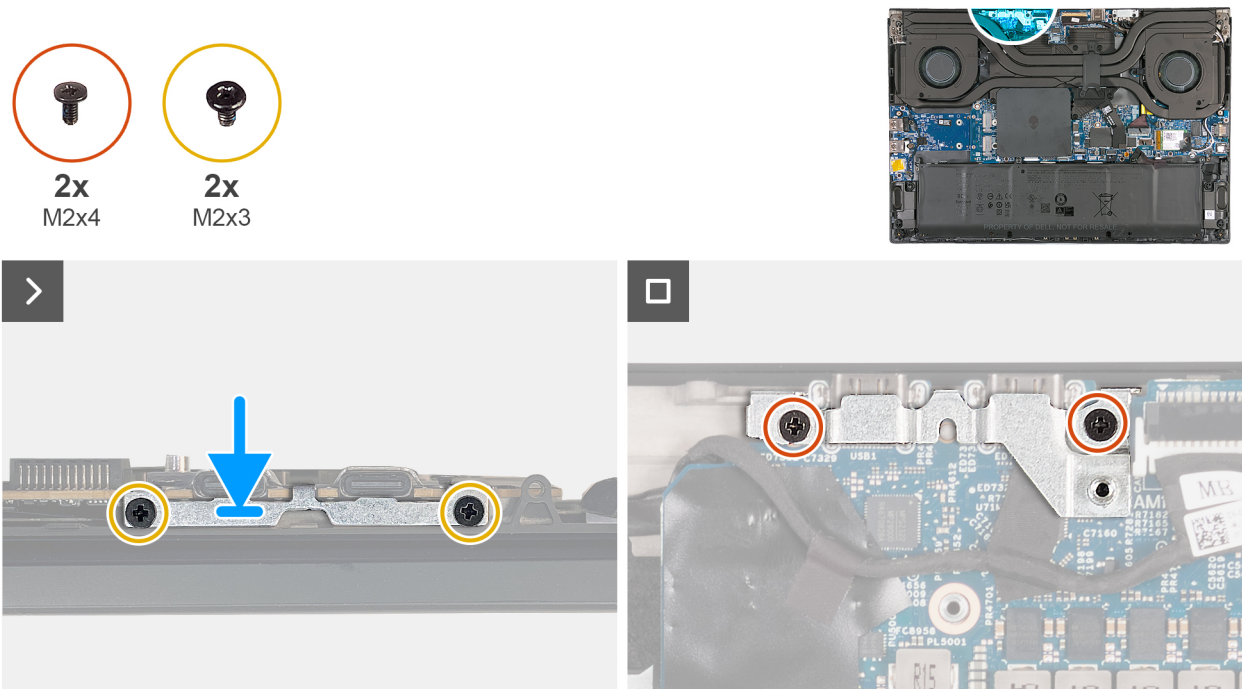

Figure 40. Installing the Type-C bracket

Steps

1. Align and place the Type-C bracket into the slot on the palm rest and keyboard assembly.
2. Align the screw holes on the Type-C bracket with the screw holes on the palm rest and keyboard assembly.
3. Replace the two screws (M2x3) that secure the Type-C bracket to the palm rest and keyboard assembly.
4. Replace the two screws (M2x4) that secure the Type-C bracket to the system board.

Next steps

1. Install the [rear I/O cover](#).
2. Install the [base cover](#).
3. Follow the procedure in [After working inside your computer](#).

System board

Removing the system board

 **CAUTION:** The information in this removal section is intended for authorized service technicians only.

Prerequisites

1. Follow the procedure in [Before working inside your computer](#).
2. Remove the [base cover](#).
3. Remove the [rear I/O cover](#).
4. Remove the [battery](#).
5. Remove the [memory](#).
6. Remove the [solid-state drive](#).
7. Remove the [wireless card](#).
8. Remove the [fan and heat-sink assembly](#).
9. Remove the [power-adaptor port](#).
10. Remove the [Type-C bracket](#).

About this task

The following image indicates the connectors on your system board.

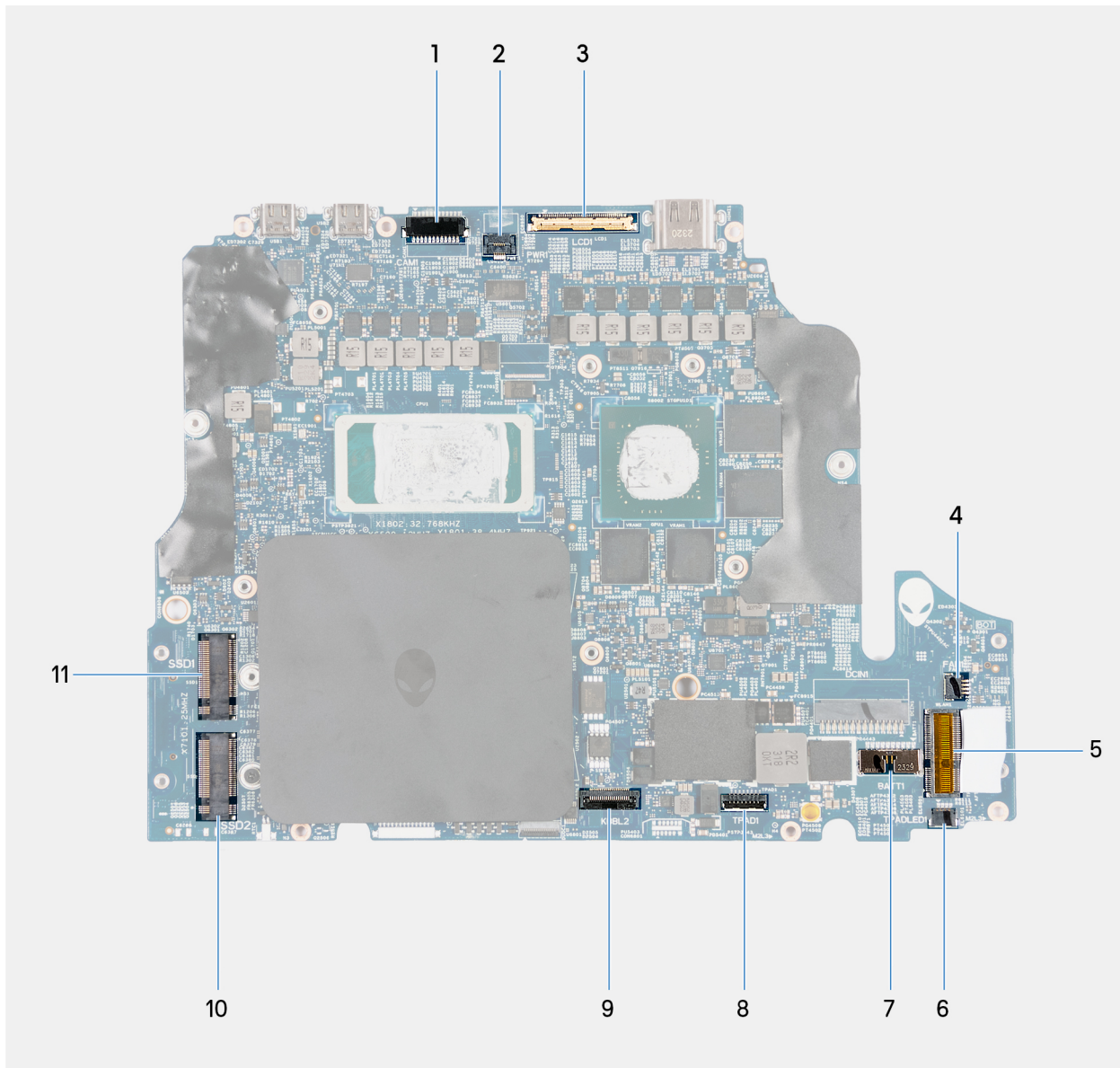

Figure 41. System-board connectors

1. Camera-cable connector (CAM1)
2. Power-button cable connector (PWR1)
3. Display-cable connector (LCD1)
4. Left-fan cable connector (FAN1)
5. Wireless-card slot (WLAN1)
6. Touchpad-LED cable connector (TPADLED1)
7. Battery-cable connector (BATT1)
8. Touchpad-cable connector (TPAD1)
9. Keyboard-controller cable connector (KBBL2)
10. M.2 2280 solid-state drive (SSD2)
11. M2.2280 solid-state drive (SSD1)

The following image(s) indicate the location of the system board and provides a visual representation of the removal procedure.



8x
M2x3

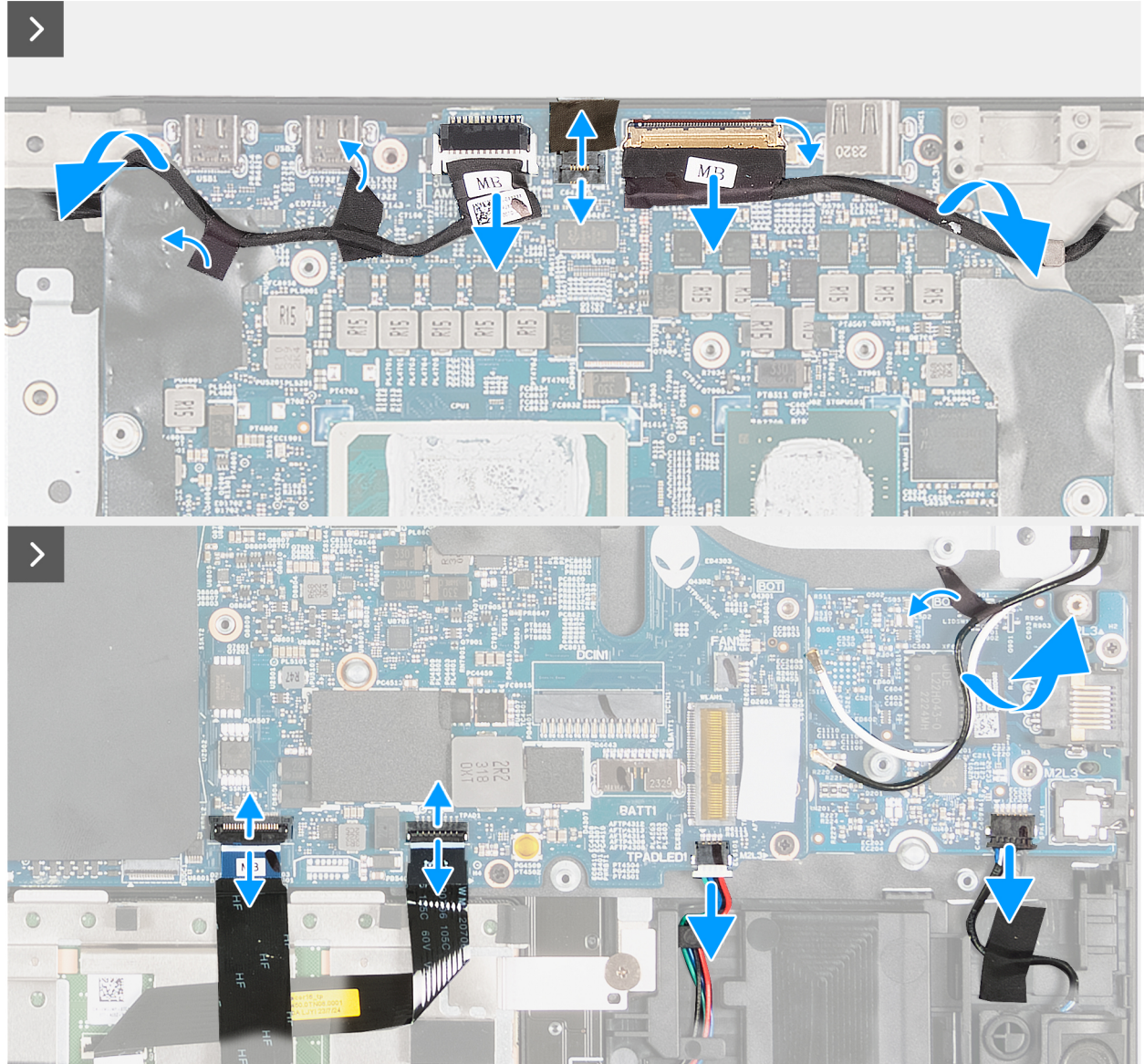
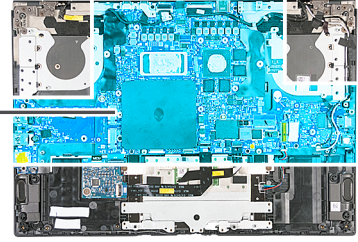

Figure 42. Removing the system board

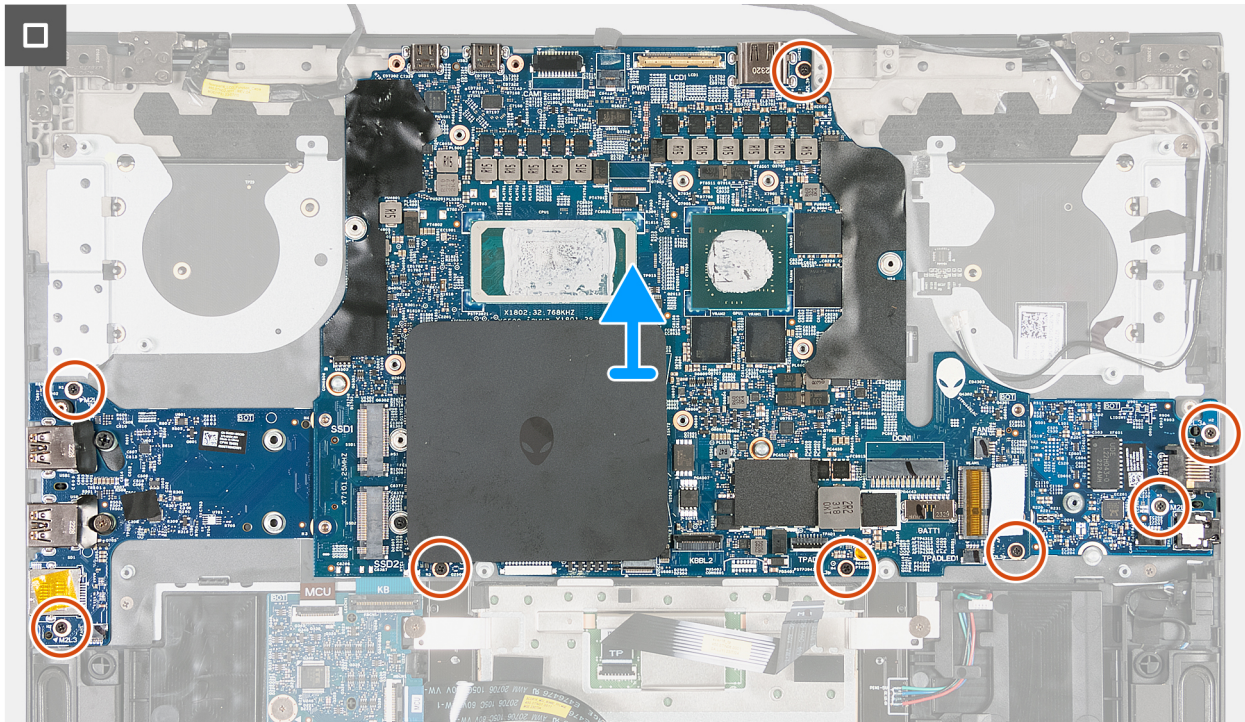

Figure 43. Removing the system board

Steps

1. Disconnect the camera cable from the connector (CAM1) on the system board.
2. Disconnect the power-button cable from the connector (PWR1) on the system board.
3. Peel the tapes that secure the camera cable to the palm-rest and keyboard assembly.
4. Open the latch and disconnect the display cable from the connector (LCD1) on the system board.
5. Open the latch and disconnect the keyboard-controller cable from the connector (KBBL2) on the system board.
6. Open the latch and disconnect the touchpad cable from the connector (TPAD1) on the system board.
7. Disconnect the touchpad-LED cable from the connector (TPADLED1) on the system board.
8. Disconnect the speaker cable from the connector (SPK1) on the audio board.
9. Remove the two screws (M2x3) that secure the I/O board to the palm rest and keyboard assembly.
10. Remove the four screws (M2x3) that secure the system board to the palm rest and keyboard assembly.
11. Remove the two screws (M2x3) that secure the audio board to the palm rest and keyboard assembly.
12. After performing all the above steps, you are left with the system-board assembly.
13. Lift the system-board assembly from the palm rest and keyboard assembly and turn it over.
14. Remove the [I/O board](#).
15. Remove the [audio board](#).

Installing the system board

⚠ CAUTION: The information in this installation section is intended for authorized service technicians only.

Prerequisites

If you are replacing a component, remove the existing component before performing the installation process.

About this task

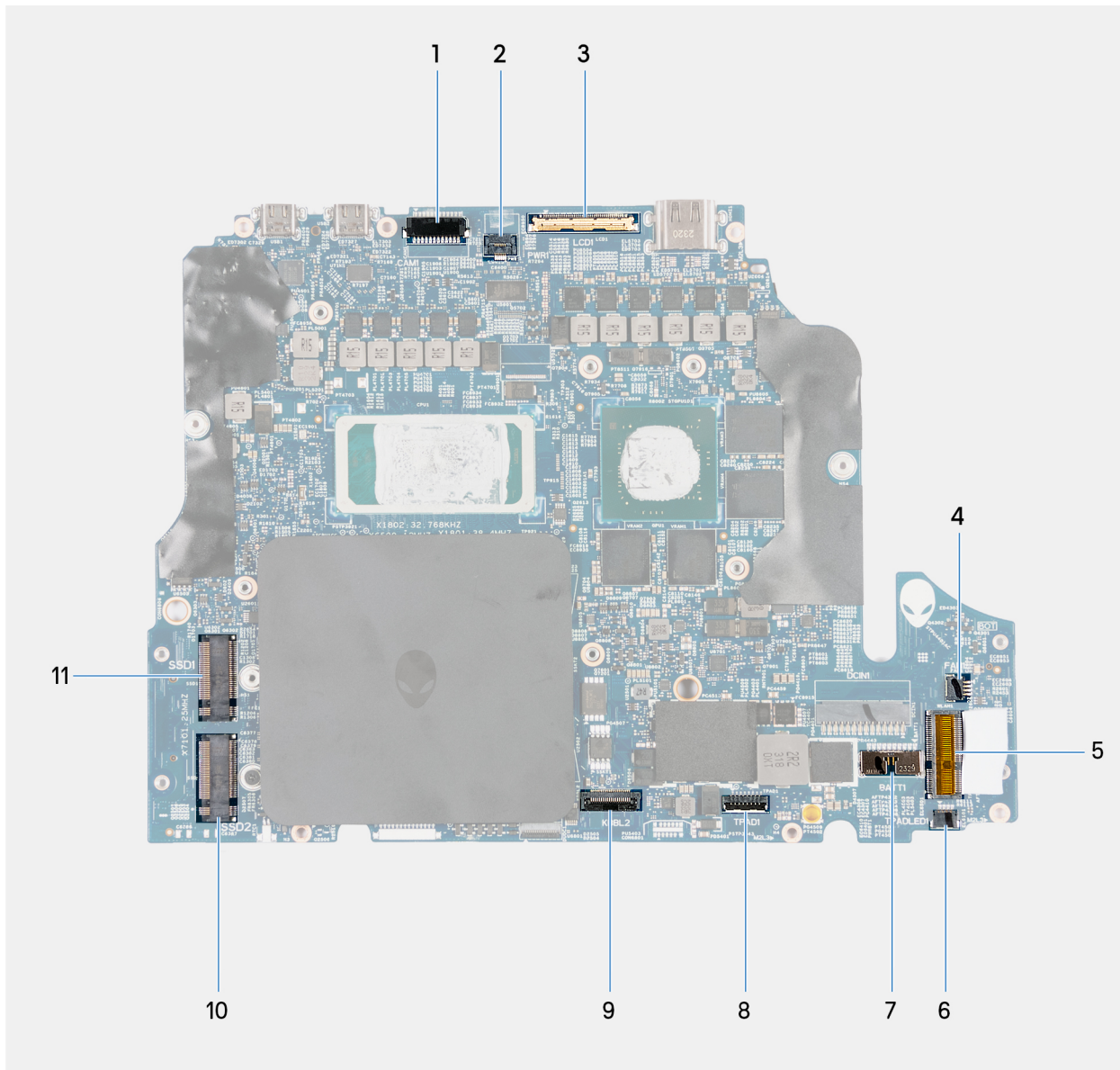

Figure 44. System-board connectors

1. Camera-cable connector (CAM1)
2. Power-button cable connector (PWR1)
3. Display-cable connector (LCD1)
4. Left-fan cable connector (FAN1)
5. Wireless-module slot (WLAN1)
6. Touchpad-LED cable connector (TPADLED1)
7. Battery-cable connector (BATT1)
8. Touchpad-cable connector (TPAD1)
9. Keyboard-controller cable connector (KBBL2)
10. M.2 2280 solid-state drive (SSD2)
11. M.2 2280 solid-state drive (SSD1)

The following image(s) indicate the location of the system board and provides a visual representation of the installation procedure.



8x
M2x3

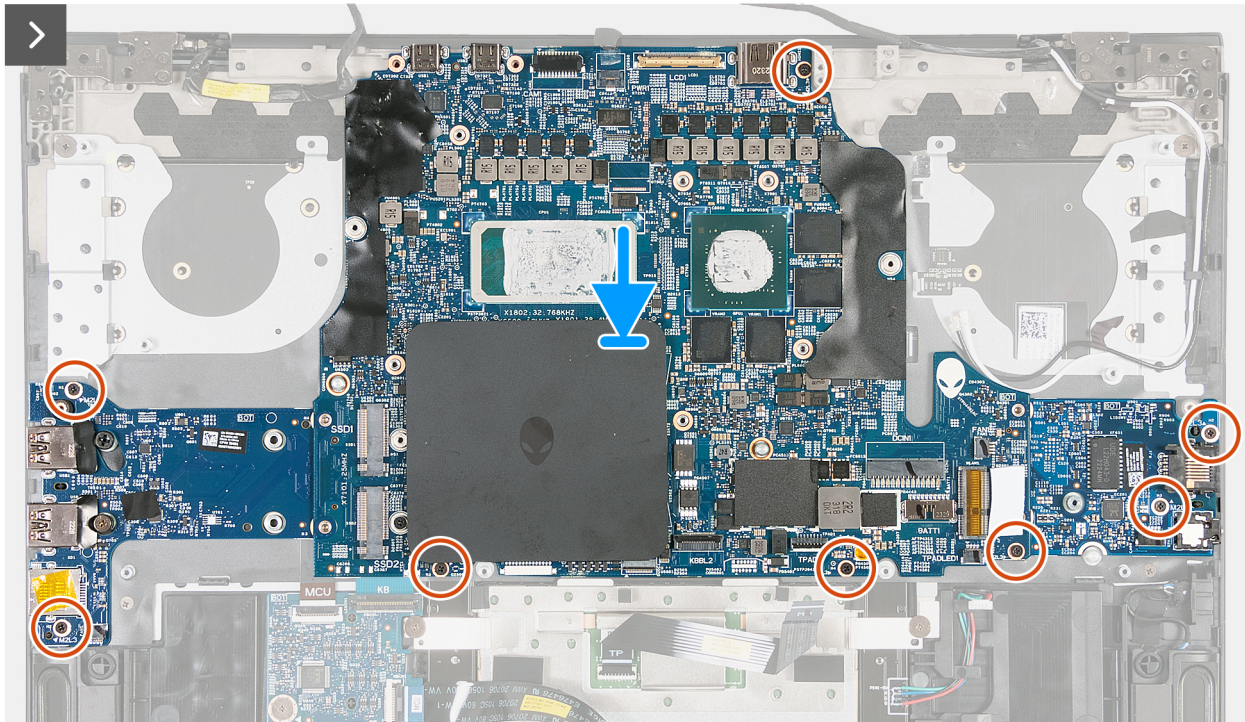
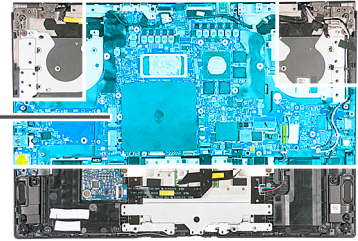

Figure 45. Installing the system board

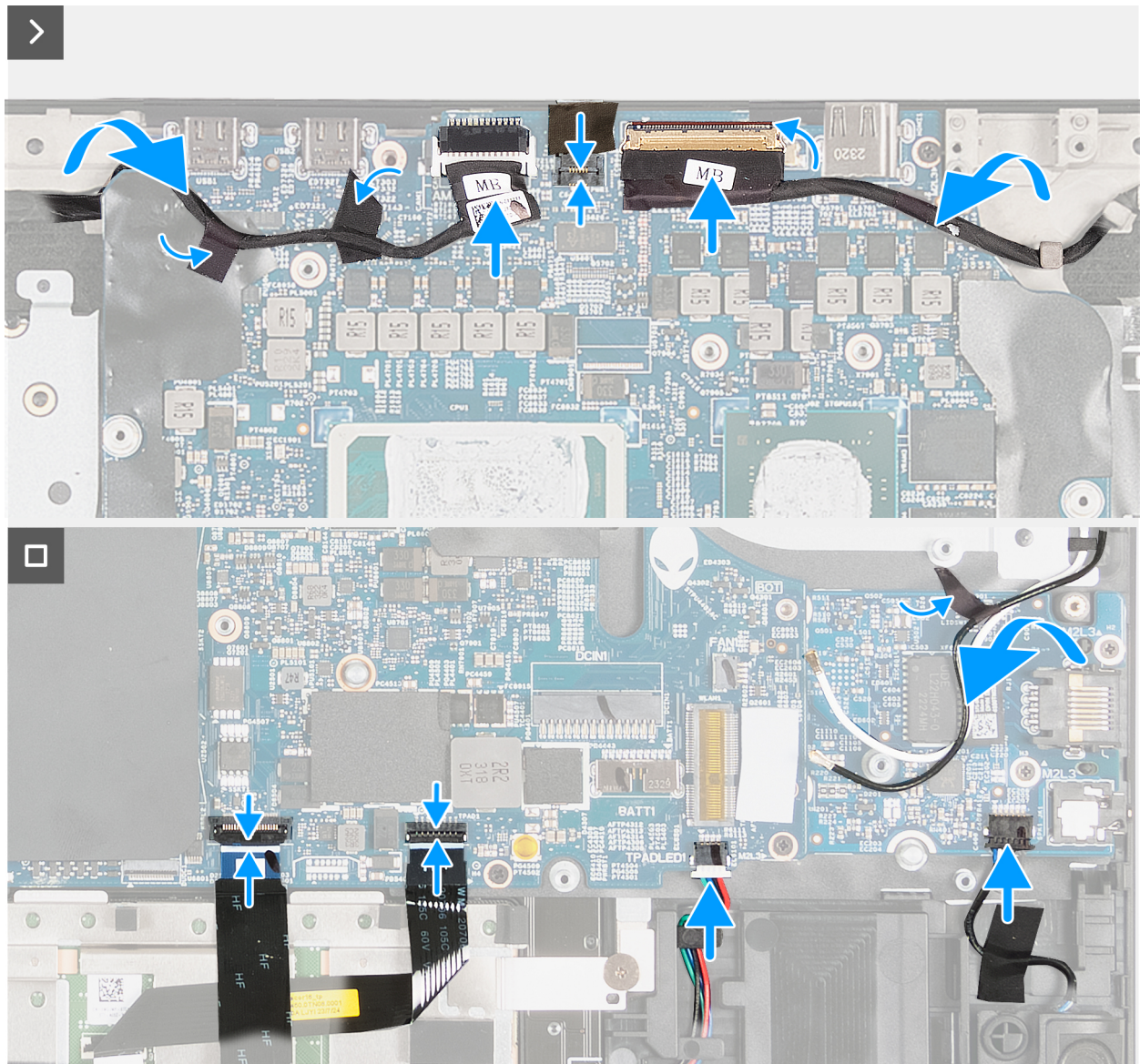

Figure 46. Installing the system board

Steps

1. Turn the system board over.
2. Install the [I/O board](#).
3. Install the [audio board](#).
4. Turn the system-board assembly over.
5. Using the alignment posts, place the system-board assembly on the palm rest and keyboard assembly.
6. Replace the two screws (M2x3) that secure the audio board to the palm rest and keyboard assembly.
7. Replace the four screws (M2x3) that secure the system board to the palm rest and keyboard assembly.
8. Replace the two screws (M2x3) that secure the I/O board to the palm rest and keyboard assembly.
9. Connect the speaker cable to the connector (SPK1) on the audio board.
10. Connect the touchpad-LED cable to the connector (TPADLED1) on the system board.
11. Connect the touchpad cable to the connector (TPAD1) on the system board.
12. Open the latch and connect the keyboard-controller cable to the connector (KBBL2) on the system board.
13. Open the latch and connect the display cable to the connector (LCD1) on the system board.
14. Connect the power-button cable to the connector (PWR1) on the system board.
15. Adhere the tapes that secure the camera cable to the palm-rest and keyboard assembly.

16. Connect the camera cable to the connector (CAM1) on the system board.

Next steps

1. Install the [Type-C bracket](#).
2. Install the [power-adapter port](#).
3. Install the [fan and heat-sink assembly](#).
4. Install the [wireless card](#).
5. Install the [solid-state drive](#).
6. Install the [memory](#).
7. Install the [battery](#).
8. Install the [rear-I/O cover](#).
9. Install the [base cover](#).
10. Follow the procedure in [After working inside your computer](#).

I/O board

Removing the I/O board

 **CAUTION:** The information in this removal section is intended for authorized service technicians only.

Prerequisites

1. Follow the procedure in [Before working inside your computer](#).
2. Remove the [base cover](#).
3. Remove the [rear I/O cover](#).
4. Remove the [battery](#).
5. Remove the [solid-state drive](#).
6. Remove the [wireless card](#).
7. Remove the [fan and heat-sink assembly](#).
8. Remove the [power-adapter port](#).
9. Remove the [Type-C bracket](#).
10. Follow the procedure from step 1 to step 11 in [Removing the system board](#).

 **NOTE:** The system board can be removed and installed along with the fan and heat sink. This simplifies the removal and installation procedure and avoids breaking the thermal bond between the system board and heat sink.

About this task

The following image(s) indicate the location of the I/O board and provides a visual representation of the removal procedure.

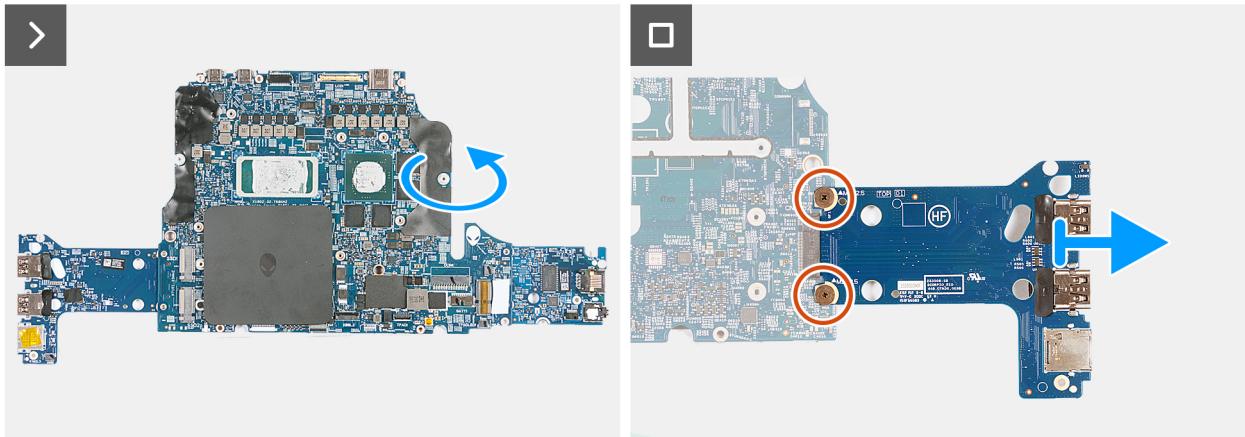
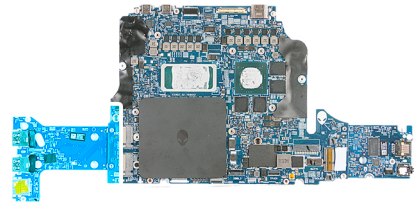



Figure 47. Removing the I/O board

Steps

1. Lift the the system board assembly from the palm rest and keyboard assembly and turn it over.
2. Remove the two screws (M2x2.5) that secure the I/O board to the system board.
3. Lift the I/O board from the system board.

Installing the I/O board

 **CAUTION:** The information in this installation section is intended for authorized service technicians only.

Prerequisites

If you are replacing a component, remove the existing component before performing the installation process.

About this task

The following image(s) indicate the location of the I/O board and provides a visual representation of the installation procedure.



2x
M2x2.5

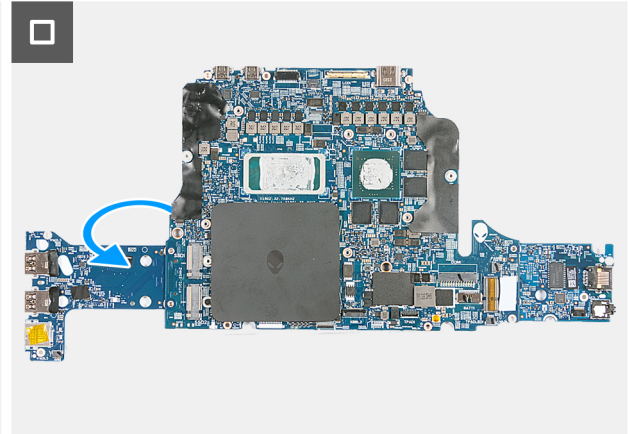
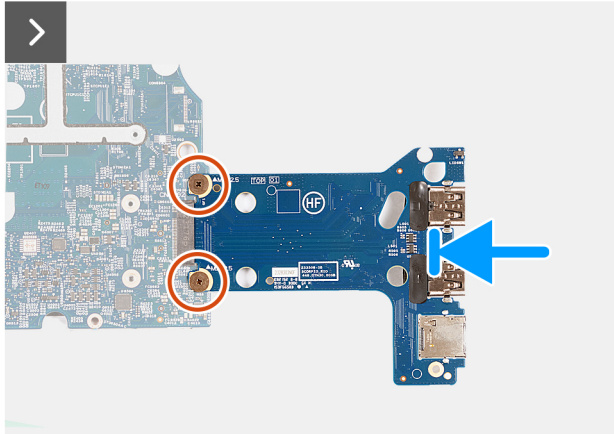
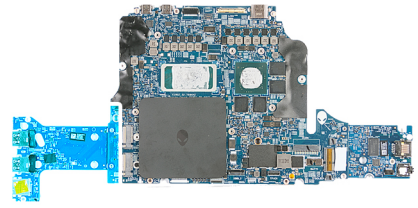

Figure 48. Installing the I/O board

Steps

1. Align the screw holes on the I/O board with the screw holes on the system board.
2. Replace the two screws (M2x2.5) that secure the I/O board to the system board.
3. Lift the system board assembly and turn it over.

Next steps

1. Follow the procedures from step 5 to step 16 in [Installing the system board](#).
2. Install the [Type-C bracket](#).
3. Install the [power-adaptor port](#).
4. Install the [fan and heat-sink assembly](#).
5. Install the [wireless card](#).
6. Install the [solid-state drive](#).
7. Install the [battery](#).
8. Install the [rear I/O cover](#).
9. Install the [base cover](#).
10. Follow the procedure in [After working inside your computer](#).

Audio board

Removing the audio board

 **CAUTION:** The information in this removal section is intended for authorized service technicians only.

Prerequisites

1. Follow the procedure in [Before working inside your computer](#).
2. Remove the [base cover](#).
3. Remove the [rear I/O cover](#).
4. Remove the [battery](#).

5. Remove the [solid-state drive](#).
6. Remove the [wireless card](#).
7. Remove the [fan and heat-sink assembly](#).
8. Remove the [power-adapter port](#).
9. Remove the [Type-C bracket](#).
10. Follow the procedure from step 1 to step 11 in [Removing the system board](#).

About this task

The following image(s) indicate the location of the I/O board and provides a visual representation of the removal procedure.

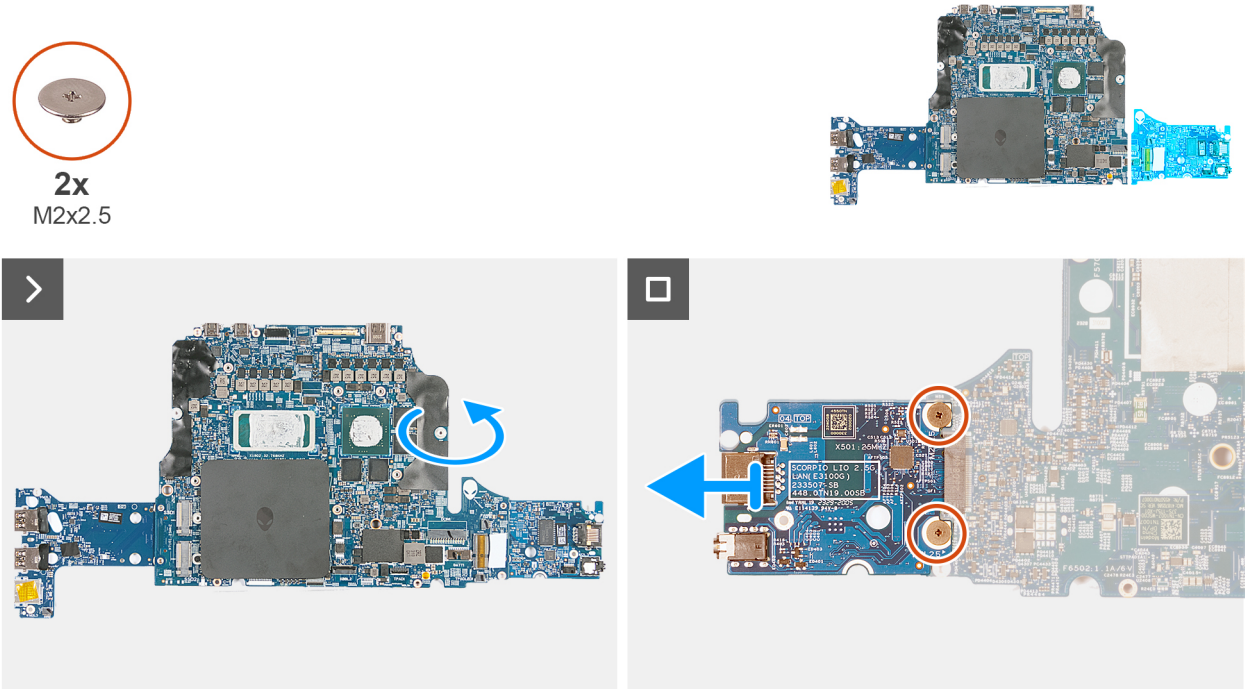

Figure 49. Removing the audio board

Steps

1. Turn over the system board with the I/O board and audio board.
2. Remove the two screws (M2x2.5) that secure the audio board to the system board.
3. Lift the audio board from the system board.

Installing the audio board

CAUTION: The information in this installation section is intended for authorized service technicians only.

Prerequisites

If you are replacing a component, remove the existing component before performing the installation process.

About this task

The following image(s) indicate the location of the audio board and provides a visual representation of the installation procedure.



2x
M2x2.5

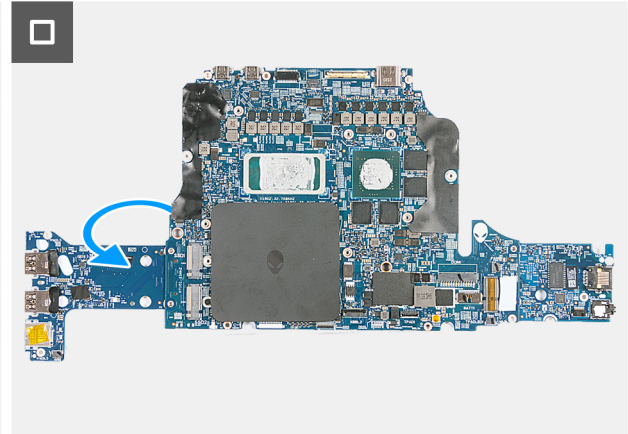
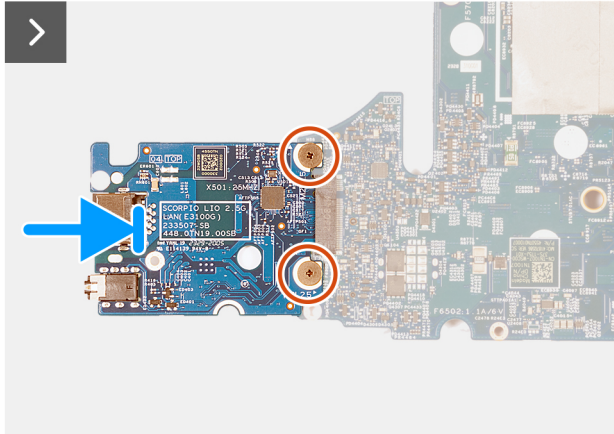
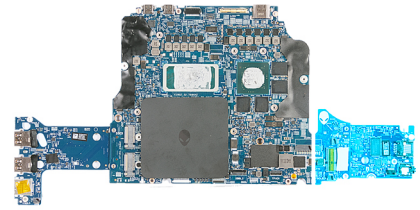

Figure 50. Installing the audio board

Steps

1. Align the screw holes on the audio board with the screw holes on the system board.
2. Replace the two screws (M2x2.5) that secure the audio board to the system board.
3. Lift the system board assembly and turn it over.

Next steps

1. Follow the procedure from step 5 to step 16 in [Installing the system board](#).
2. Install the [Type-C bracket](#).
3. Install the [power-adaptor port](#).
4. Install the [fan and heat-sink assembly](#).
5. Install the [wireless card](#).
6. Install the [solid-state drive](#).
7. Install the [battery](#).
8. Install the [rear I/O cover](#).
9. Install the [base cover](#).
10. Follow the procedure in [After working inside your computer](#).

Power button

Removing the power button

⚠ CAUTION: The information in this removal section is intended for authorized service technicians only.

Prerequisites

1. Follow the procedure in [Before working inside your computer](#).
2. Remove the [base cover](#).
3. Remove the [rear I/O cover](#).
4. Remove the [battery](#).

5. Remove the [power-adaptor port](#).
6. Remove the [Type-C bracket](#).
7. Follow the procedure from step 1 to step 11 in [Removing the system board](#).

NOTE: The system board can be removed and installed along with the memory, audio board, wireless card, and fan and heat sink-assembly. This simplifies the removal and installation procedure and avoids breaking the thermal bond between the system board and heat sink.

About this task

The following image(s) indicate the location of the power button and provides a visual representation of the removal procedure.

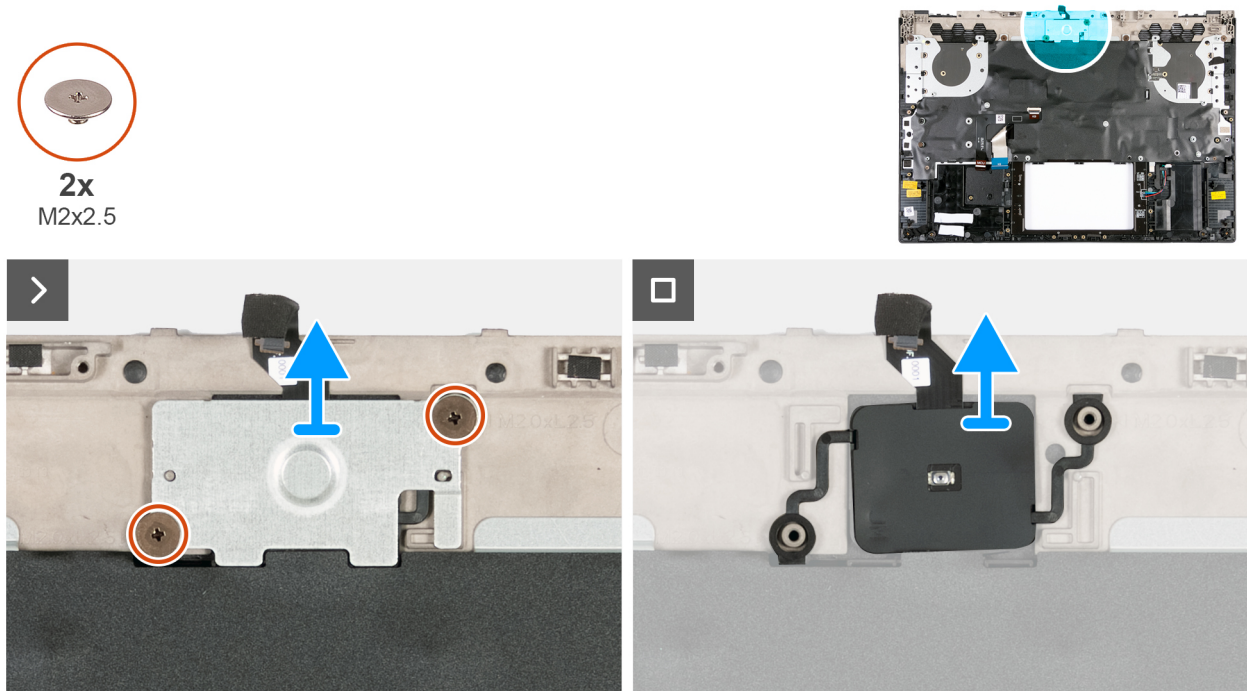

Figure 51. Removing the power button

Steps

1. Remove the two screws (M2x2.5) that secure the power-button bracket to the palm rest and keyboard assembly.
2. Lift the power-button bracket off the power button.
3. Lift the power button, along with its cable, off the palm rest and keyboard assembly.

Installing the power button

CAUTION: The information in this installation section is intended for authorized service technicians only.

Prerequisites

If you are replacing a component, remove the existing component before performing the installation process.

About this task

The following image(s) indicate the location of the power button and provides a visual representation of the installation procedure.



2x
M2x2.5

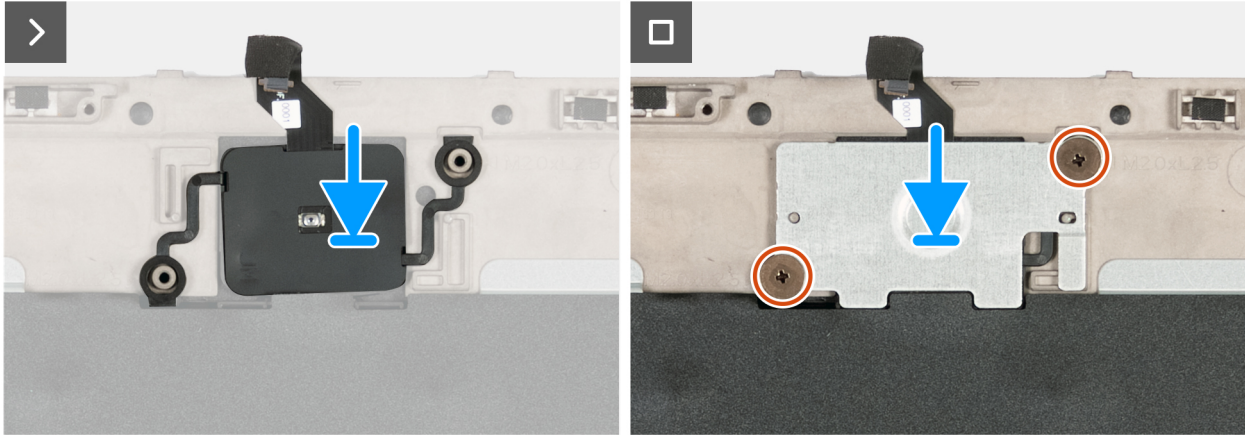
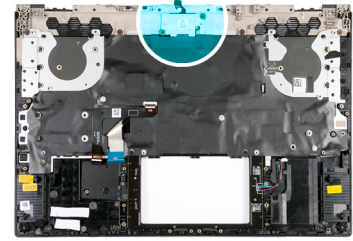

Figure 52. Installing the power button

Steps

1. Align and place the power button, along with its cable, into the slot on the palm rest and keyboard assembly.
2. Align the screw holes on the power-button bracket with the screw holes on the palm rest and keyboard assembly.
3. Replace the two screws (M2x2.5) that secure the power-button bracket to the palm rest and keyboard assembly.

Next steps

1. Follow the procedure from step 5 to step 16 in [Installing the system board](#).
2. Install the [Type-C bracket](#).
3. Install the [power-adapter port](#).
4. Install the [battery](#).
5. Install the [rear I/O cover](#).
6. Install the [base cover](#).
7. Follow the procedure in [After working inside your computer](#).

Palm rest and keyboard assembly

Removing the palm rest and keyboard assembly

 **CAUTION:** The information in this removal section is intended for authorized service technicians only.

Prerequisites

1. Follow the procedure in [Before working inside your computer](#).
2. Remove the [base cover](#).
3. Remove the [rear I/O cover](#).
4. Remove the [battery](#).
5. Remove the [speakers](#).
6. Remove the [power-adapter port](#).
7. Remove the [touchpad](#).

8. Remove the [display assembly](#).
9. Remove the [keyboard-controller board](#).
10. Follow the procedure from step 1 to step 11 in [Removing the system board](#).

i NOTE: The system board can be removed and installed along with the memory, audio board, wireless card, and fan and heat sink-assembly. This simplifies the removal and installation procedure and avoids breaking the thermal bond between the system board and heat sink.

11. Remove the [power button](#).

About this task

The following image(s) indicate the location of the palm rest and keyboard assembly and provides a visual representation of the removal procedure.

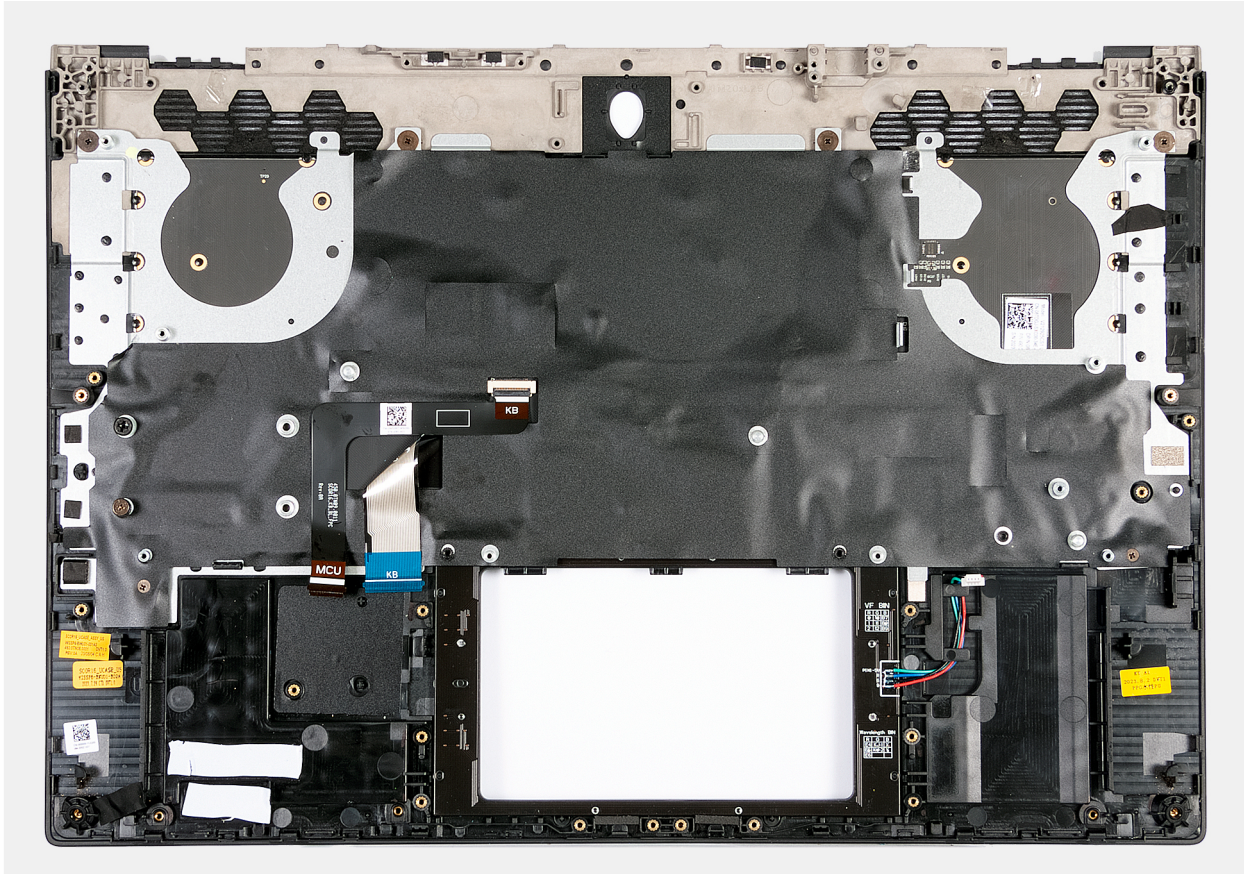

Figure 53. Removing the palm rest and keyboard assembly

Steps

After performing the pre-requisites you are left with the palm rest and keyboard assembly.

i NOTE: Ensure that the solid-state drive mounts on slot one and two are removed from the old palm-rest and keyboard assembly before installing the new palm rest and keyboard assembly. These solid-state drive mounts are to be installed onto the new palm rest and keyboard assembly.

Installing the palm rest and keyboard assembly

⚠ CAUTION: The information in this installation section is intended for authorized service technicians only.

Prerequisites

If you are replacing a component, remove the existing component before performing the installation process.

About this task

The following image(s) indicate the location of the palm rest and keyboard assembly and provides a visual representation of the installation procedure.

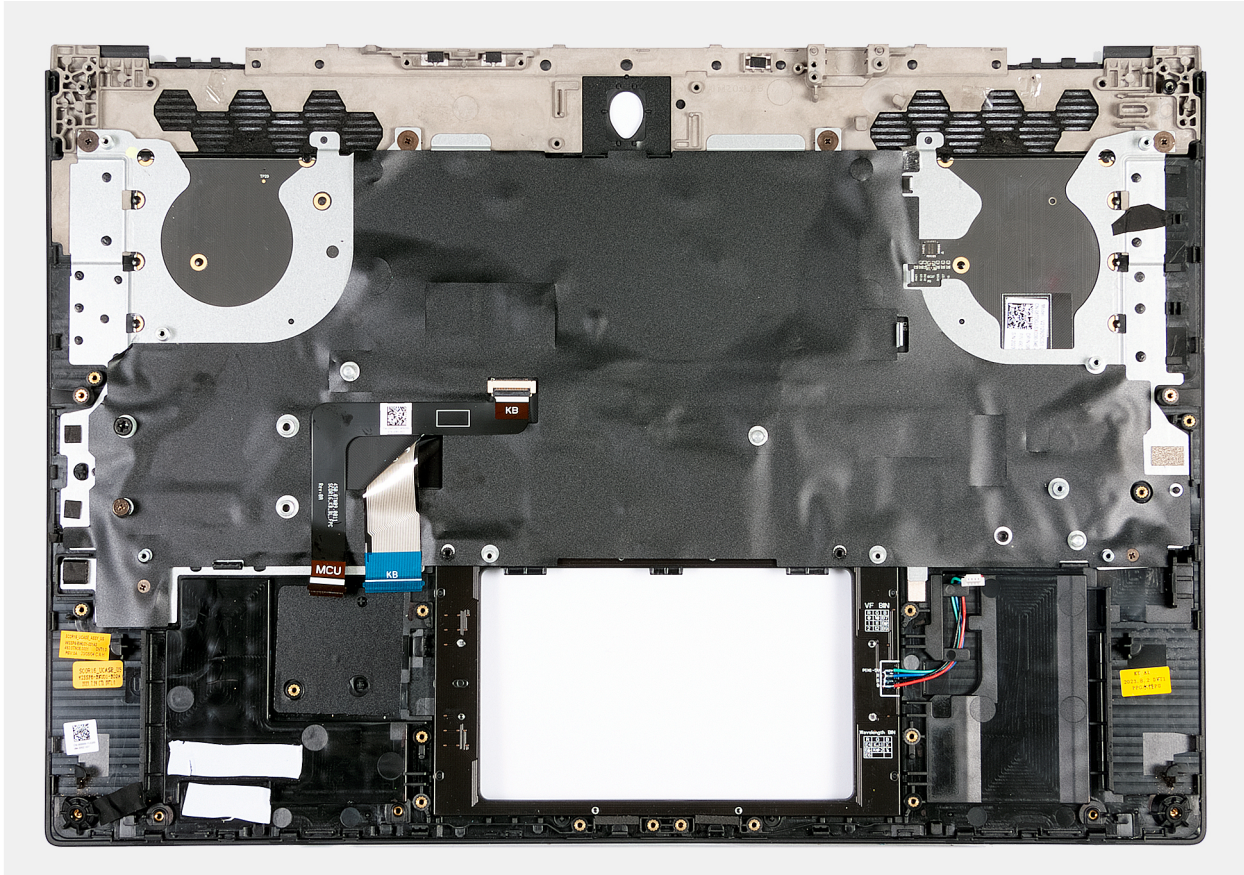

Figure 54. Installing the palm rest and keyboard assembly

Steps

Place the palm rest and keyboard assembly on a flat and clean surface and perform the post-requisites to install the palm rest and keyboard assembly.

i **NOTE:** Install the solid-state drive mounts on the slots from the old palm rest and keyboard assembly onto the new palm rest and keyboard assembly.

Next steps

1. Install the [power button](#).
2. Follow the procedure from step 5 to step 16 in [Installing the system board](#).
3. Install the [keyboard-controller board](#).
4. Install the [display assembly](#).
5. Install the [touchpad](#).
6. Install the [power-adapter port](#).
7. Install the [speakers](#).
8. Install the [battery](#).
9. Install the [rear-I/O cover](#).
10. Install the [base cover](#).
11. Follow the procedure in [After working inside your computer](#).

Software

This chapter details the supported operating systems along with instructions on how to install the drivers.

Operating system

Your Alienware m16 R2 supports the following operating systems:

- Windows 11 Home (64-bit)
- Windows 11 Professional (64-bit)

Drivers and downloads

When troubleshooting, downloading, or installing drivers, it is recommended that you read the Dell Knowledge Base article Drivers and Downloads FAQs [000123347](#).

BIOS Setup

CAUTION: Unless you are an expert computer user, do not change the settings in the BIOS Setup. Certain changes can make your computer work incorrectly.

NOTE: Depending on the computer and its installed devices, the items that are listed in this section may or may not be displayed.

NOTE: Before you change the settings in BIOS Setup, it is recommended that you note down the original settings for future reference.

Use BIOS Setup for the following purposes:

- Get information about the hardware installed in your computer, such as the amount of RAM and the size of the storage device.
- Change the system configuration information.
- Set or change a user-selectable option, such as the user password, type of hard drive installed, and enabling or disabling base devices.

Entering BIOS setup program

About this task

Turn on (or restart) your computer and press F2 immediately.

Navigation keys

NOTE: For most of the System Setup options, changes that you make are recorded but do not take effect until you restart the computer.

Table 28. Navigation keys

Keys	Navigation
Up arrow	Moves to the previous field.
Down arrow	Moves to the next field.
Enter	Selects a value in the selected field (if applicable) or follows the link in the field.
Spacebar	Expands or collapses a drop-down list, if applicable.
Tab	Moves to the next focus area. NOTE: For the standard graphical user interface only.
Esc	Moves to the previous page until you view the main screen. Pressing Esc in the main screen displays a message that prompts you to save any unsaved changes and restart the computer.

F12 One Time Boot menu

To enter the One Time Boot menu, turn on your computer, and then press F12 immediately.

 **NOTE:** It is recommended to shut down the computer, if it is on.

The F12 One Time Boot menu displays the devices that you can boot from including the diagnostic option. The boot menu options are:

- Removable Drive (if available)
- STXXXX Drive (if available)

 **NOTE:** XXX denotes the SATA drive number.

- Optical Drive (if available)
- SATA Hard Drive (if available)
- Diagnostics

The boot sequence screen also displays the option to access System Setup.

System setup options

 **NOTE:** Depending on your computer and its installed devices, the items that are listed in this section may or may not be displayed.

Table 29. System setup options—Overview menu

Overview

Alienware m16 R2

BIOS Version	Displays the BIOS version number.
Service Tag	Displays the Service Tag of the computer.
Asset Tag	Displays the Asset Tag of the computer.
Manufacture Date	Displays the manufacture date of the computer.
Ownership Date	Displays the ownership date of the computer.
Express Service Code	Displays the Express Service Code of the computer.
Ownership Tag	Displays the Ownership Tag of the computer.
Signed Firmware Update	Displays whether the Signed Firmware Update is enabled on your computer. By default, the Signed Firmware Update option is enabled.

BATTERY

Primary	Displays the primary battery of the computer.
Battery Level	Displays the battery level of the computer.
Battery State	Displays the battery state of the computer.
Health	Displays the battery health of the computer.
AC Adapter	Displays whether an AC adapter is connected. If connected, displays the type of AC adapter that is connected.

PROCESSOR

Processor Type	Displays the processor type.
Maximum Clock Speed	Displays the maximum processor clock speed.
Minimum Clock Speed	Displays the minimum processor clock speed.
Current Clock Speed	Displays the current processor clock speed.
Core Count	Displays the number of cores on the processor.
Processor ID	Displays the processor identification code.

Table 29. System setup options—Overview menu (continued)

Overview	
Processor L2 Cache	Displays the processor L2 Cache size.
Processor L3 Cache	Displays the processor L3 Cache size.
Microcode Version	Displays the microcode version.
Intel Hyper-Threading Capable	Displays whether the processor is Hyper-Threading (HT) capable.
64-Bit Technology	Displays whether 64-bit technology is used.
MEMORY	
Memory Installed	Displays the total computer memory installed.
Memory Available	Displays the total computer memory available.
Memory Speed	Displays the memory speed.
Memory Channel Mode	Displays single or dual channel mode.
Memory Technology	Displays the technology that is used for the memory.
DIMM_SLOT 1	Displays the capacity of the memory module in slot 1.
DIMM_SLOT 2	Displays the capacity of the memory module in slot 2.
DEVICES	
Panel Type	Displays the panel type of the computer.
Panel Revision	Displays the panel revision number.
Video Controller	Displays the video controller type of the computer.
Video Memory	Displays the video memory information of the computer.
Wi-Fi Device	Displays the wireless device information of the computer.
Native Resolution	Displays the native resolution of the computer.
Video BIOS Version	Displays the video BIOS version of the computer.
Audio Controller	Displays the audio controller information of the computer.
Bluetooth Device	Displays the Bluetooth device information of the computer.
LOM MAC Address	Displays the LAN on motherboard MAC address of the computer.
dGPU Video Controller	Displays the video controller information of the computer.

Table 30. System setup options—Boot Configuration menu

Boot Configuration	
Boot Sequence	
Boot Mode: UEFI only	Displays the boot mode of the computer.
Boot Sequence	Displays the boot sequence.
Enable PxE Boot Priority	Enables or disables the addition of a newly detected PxE boot option to the boot sequence.
Secure Digital (SD) Card Boot	Enables or disables read-only boot from Secure Digital (SD) card. By default, the Secure Digital (SD) Card Boot option is disabled.
Secure Boot	Secure Boot is a method of guaranteeing the integrity of the boot path by performing additional validation of the operating system and PCI add-in cards. The computer stops booting to the operating system when a component is not authenticated during the boot process. Secure Boot can be enabled in BIOS setup

Table 30. System setup options—Boot Configuration menu (continued)

Boot Configuration	
	or using management interfaces like Dell Command Configure, but can only be disabled from BIOS setup.
Enable Secure Boot	<p>Enables the computer to boot using only validated boot software.</p> <p>By default, the Enable Secure Boot option is disabled.</p> <p>For additional security, Dell Technologies recommends keeping the Secure Boot option enabled to ensure that the UEFI firmware validates the operating system during the boot process.</p> <p>i NOTE: For Secure Boot to be enabled, the computer is required to be in UEFI boot mode and the Enable Legacy Option ROMs option is required to be turned off.</p>
Enable Microsoft UEFI CA	<p>When disabled, the UEFI CA is removed from the BIOS UEFI Secure Boot database.</p> <p>i NOTE: When disabled, the Microsoft UEFI CA could render your computer unable to boot, computer graphics may not function, some devices may not function properly, and the computer could become unrecoverable.</p> <p>By default, the Enable Microsoft UEFI CA option is enabled.</p> <p>For additional security, Dell Technologies recommends keeping the Microsoft UEFI CA option enabled to ensure the broadest compatibility with devices and operating systems.</p>
Secure Boot Mode	<p>Enables or disables the Secure Boot operation mode.</p> <p>By default, the Deployed Mode is selected.</p> <p>i NOTE: Deployed Mode should be selected for normal operation of Secure Boot.</p>
Expert Key Management	
Enable Custom Mode	<p>Enables or disables the keys in the PK, KEK, db, and dbx security key databases to be modified.</p> <p>By default, the Enable Custom Mode option is disabled.</p>
Custom Mode Key Management	<p>Selects the custom values for expert key management.</p> <p>By default, the PK option is selected.</p>

Table 31. System setup options—Integrated Devices menu

Integrated Devices	
Date/Time	
Date	Sets the computer date in MM/DD/YYYY format. Changes to the date format take effect immediately.
Time	Sets the computer time in HH/MM/SS 24-hour format. You can switch between a 12-hour and 24-hour clock. Changes to the time format take effect immediately.
Camera	
Enable Camera	<p>Enables the camera.</p> <p>By default, the Enable Camera option is enabled.</p> <p>i NOTE: Depending on the configuration ordered, the camera setup option may not be available.</p>
Audio	
Enable Audio	Enables all integrated audio controller.

Table 31. System setup options—Integrated Devices menu (continued)

Integrated Devices	
	By default, all the options are enabled.
Enable Microphone	<p>Enables the microphone.</p> <p>By default, the Enable Microphone option is enabled.</p> <p> NOTE: Depending on the configuration ordered, the microphone setup option may not be available.</p>
Enable Internal Speaker	<p>Enables the internal speaker.</p> <p>By default, the Enable Internal Speaker option is enabled.</p>
USB/Thunderbolt Configuration	
Enable External USB Ports	<p>Enables the external USB ports.</p> <p>By default, the Enable External USB Ports option is enabled.</p>
Enable USB Boot Support	<p>Enables booting from USB mass storage devices that are connected to external USB ports.</p> <p>By default, the Enable USB Boot Support option is enabled.</p>
Enable Thunderbolt Technology Support	<p>Enables the associated ports and adapters for Thunderbolt Technology support.</p> <p>By default, the Enable Thunderbolt Technology Support option is enabled.</p>
Enable Thunderbolt Boot Support	<p>Enables the Thunderbolt adapter-peripheral device and USB devices that are connected to the Thunderbolt adapter to be used during BIOS Preboot.</p> <p>By default, the Enable Thunderbolt Boot Support option is disabled.</p>
Enable Thunderbolt (and PCIe behind TBT) pre-boot modules	<p>Enables the PCIe devices that are connected through a Thunderbolt adapter to run the PCIe devices UEFI Option ROM (if present) during preboot.</p> <p>By default, the Enable Thunderbolt (and PCIe behind TBT) pre-boot modules option is disabled.</p>
Disable USB4 PCIE Tunneling	<p>Disables the USB4 PCIE Tunneling option.</p> <p>By default, the Disable USB4 PCIE Tunneling option is disabled.</p>
Video/Power only on Type-C Ports	<p>Enables or disables the Type-C port functionality to video or only power.</p> <p>By default, the Video/Power only on Type-C Ports option is disabled.</p>
Type-C Dock	
Type-C Dock Override	<p>Enables or disables to use connected Type-C Dell Dock to provide data stream with external USB ports disabled. When Type-C Dock override is enabled, the Video/Audio/LAN submenu is activated.</p> <p>By default, the Type-C Dock Override option is enabled.</p>
Type-C Dock Video	<p>Enables or disables the usage of video inputs and outputs from the connected Type-C Dell docking station.</p> <p>By default, the Type-C Dock Video option is enabled.</p>
Type-C Dock Audio	<p>Enables or disables the usage of audio inputs and outputs from the connected Type-C Dell docking station.</p> <p>By default, the Type-C Dock Audio option is enabled.</p>
Type-C Dock LAN	<p>Enables or disables the usage of LAN on the external ports of the connected Type-C Dell docking station.</p> <p>By default, the Type-C Dock LAN option is enabled.</p>

Table 32. System setup options—Storage menu

Storage

SATA/NVMe Operation

SATA/NVMe Operation	Sets the operating mode of the storage device. By default, the RAID On option is selected. The storage device is configured for RAID mode.
---------------------	--

Storage Interface

Port Enablement	Displays the information of various onboard drives. Enables or disables the onboard drive. By default, the option is enabled.
-----------------	---

SMART Reporting

Enable SMART Reporting	Enables or disables the reporting of hard drive errors for integrated drives during startup.
Drive Information	Displays the information of onboard drives.

Enable MediaCard

Secure Digital (SD) Card	Enables or disables the SD card. By default, the Secure Digital (SD) Card option is enabled.
Secure Digital (SD) Card Read-Only Mode	Enables or disables the SD card read-only mode. By default, the Secure Digital (SD) Card Read-Only Mode option is disabled.

Table 33. System setup options—Display menu

Display

Display Brightness

Brightness on battery power	Enables to set the screen brightness when the computer is running on battery power. By default, the screen brightness is set to 50 when the computer is running on battery power.
Brightness on AC power	Enables to set the screen brightness when the computer is running on AC power. By default, the screen brightness is set to 100 when the computer is running on AC power.

Full Screen Logo

	Enables or disables the computer to display a full-screen logo, if the image matches screen resolution. By default, the Full Screen Logo option is disabled.
--	--

Hybrid Graphics/ Advanced Options

Enable Hybrid Graphics/ Advanced Options (when available)	Enables or disables the ability of both integrated and discrete graphics controller working together for optimized capability and batter life. By default, the Enable Hybrid Graphics/ Advanced Options (when available) option is enabled.
---	---

Table 34. System setup options—Connection menu

Connection

Network Controller Configuration

Integrated NIC	Sets the option controls on the onboard LAN controller. By default, the Enabled with PxE option is selected.
----------------	--

Table 34. System setup options—Connection menu (continued)

Connection

Wireless Device Enable

WLAN/WiGig	Enables or disables the internal WLAN device. By default, the WLAN option enabled.
Bluetooth	Enables or disables the internal Bluetooth device. By default, the Bluetooth option enabled.
Enable UEFI Network Stack	Enables or disables the UEFI Network Stack and controls the onboard LAN Controller. By default, the Auto Enabled option is enabled.
HTTP(s) Boot Feature	
HTTP(s) Boot	Enables or disables HTTP(s) Boot capabilities. By default, the option is enabled.
HTTP(s) Boot Modes	Sets the method on how to read the Boot URL. By default, the Auto Mode option is enabled.

Table 35. System setup options—Power menu

Power

Battery Configuration

Enables or disables the computer to run on battery during peak power usage hours. Use the table **Custom Charge Start** and **Custom Charge Stop**, to prevent AC power usage between certain times of each day.
By default, the **Adaptive** option is selected. Battery settings are adaptively optimized based on your typical battery usage pattern.

Advanced Configuration

Enable Advanced Battery Charge Configuration
Enables Advanced Battery Charge Configuration from the beginning of the day to a specified work period. When enabled, Advanced Battery Charged maximizes battery health while still supporting heavy use during the work day.
By default, the **Enable Advanced Battery Charge Configuration** option is disabled.

USB PowerShare

Enable USB PowerShare
Enables or disables the designated PowerShare port to charge external devices (such as phones and portable music players) using the stored system battery.
By default, the **Enable USB PowerShare** option is disabled.

Thermal Management

Enables or disables cooling of fan and manages processor heat to adjust the computer performance, noise, and temperature.
By default, the **Optimized** option is selected. Standard setting for balanced performance, noise, and temperature.

USB Wake Support

Wake on Dell USB-C Dock
When enabled, connecting a Dell USB-C Dock wakes the computer from Standby, Hibernate, and Power Off.
By default, the **Wake on Dell USB-C Dock** option is enabled.

Block Sleep

Enables or disables the computer from entering Sleep (S3) mode in the operating system.
By default, the **Block Sleep** option is disabled.

Table 35. System setup options—Power menu (continued)

Power

NOTE: When enabled, the computer does not go to Sleep, Intel Rapid Start is disabled automatically, and the operating system power option is blank if it was set to Sleep.

Lid Switch

Enable Lid Switch Enables or disables the Lid Switch.
By default, the **Enable Lid Switch** option is enabled.

Power On Lid Open When enabled, it allows the computer to turn on from the off state whenever the lid is opened.
By default, the **Power On Lid Open** option is enabled.

Intel Speed Shift Technology Enables or disables the Intel Speed Shift Technology support. When enabled, the operating system selects the appropriate processor performance automatically.
By default, the **Intel Speed Shift Technology** option is enabled.

Table 36. System setup options—Security menu

Security

Intel Platform Trust Technology Intel PTT is a firmware-based Trusted Platform Module (fTPM) device that is part of Intel chipsets. It provides credential storage and key management that can replace the equivalent functionality of a discrete TPM chip.
NOTE: The options that are listed apply to computers with a discrete **Trusted Platform Module (TPM)**.

Intel Platform Trust Technology On Enables or disables the Intel Platform Trust Technology On option.
By default, the **Platform Trust Technology On** option is enabled.
For additional security, Dell Technologies recommends keeping the **Platform Trust Technology On** option enabled.

Physical Presence Interface (PPI) Bypass for Clear Commands The PPI Bypass for Clear Commands option allows the operating system to manage certain aspects of PTT. When enabled, you are not prompted to confirm changes to the PTT configuration.
By default, the **PPI Bypass for Clear Commands** option is disabled.
For additional security, Dell Technologies recommends keeping the **PPI Bypass for Clear Commands** option disabled.

Clear When enabled, the **Clear** option clears the information that is stored in the PTT fTPM after exiting the computer's BIOS. This option returns to the disabled state when the computer restarts.
By default, the **Clear** option is disabled.
Dell Technologies recommends enabling the **Clear** option only when PTT fTPM data needs to be cleared.

SMM Security Mitigation Enables or disables additional UEFI SMM Security Mitigation protections. This option uses the Windows SMM Security Mitigations Table (WSMT) to confirm to the operating system that security best practices have been implemented by the UEFI firmware.
By default, the **SMM Security Mitigation** option is enabled.
For additional security, Dell Technologies recommends keeping the **SMM Security Mitigation** option enabled unless you have a specific application which is not compatible.

Table 36. System setup options—Security menu (continued)

Security

 **NOTE:** This feature may cause compatibility issues or loss of functionality with some legacy tools and applications.

Data Wipe on Next Boot

Start Data Wipe

Data Wipe is a secure wipe operation that deletes information from a storage device.

 **CAUTION:** The secure Data Wipe operation deletes information in a way that it cannot be reconstructed.

Commands such as delete and format in the operating system may remove files from showing up in the file system. However, they can be reconstructed through forensic means as they are still represented on the physical media. Data Wipe prevents this reconstruction and is not recoverable.

When enabled, the data wipe option will prompt to wipe any storage devices that are connected to the computer on the next boot.

By default, the **Start Data Wipe** option is disabled.

Absolute

Absolute Software provides various cyber security solutions, some requiring software preloaded on Dell computers and integrated into the BIOS. To use these features, you must enable the Absolute BIOS setting and contact Absolute for configuration and activation.

By default, the **Absolute** option is enabled.

For additional security, Dell Technologies recommends keeping the **Absolute** option enabled.

 **NOTE:** When the Absolute features are activated, the Absolute integration cannot be disabled from the BIOS setup screen.

UEFI Boot Path Security

Enables or disables the computer to prompt the user to enter the Administrator password (if set) when booting to a UEFI boot path device from the F12 boot menu.

By default, the **Always Except Internal HDD** option is enabled.

Firmware Device Tamper Detection

Allows you to control the firmware device tamper detection feature. This feature notifies the user when the firmware device is tampered. When enabled, a screen warning messages are displayed on the computer and a tamper detection event is logged in the BIOS Events log. The computer fails to reboot until the event is cleared.

By default, the **Firmware Device Tamper Detection** option is enabled.

For additional security, Dell Technologies recommends keeping the **Firmware Device Tamper Detection** option enabled.

Clear Firmware Device Tamper Detection

Enables or disables the option to clear the event.

Table 37. System setup options—Passwords menu

Passwords

Admin Password

The Administrator Password prevents unauthorized access to the BIOS setup options. Once the administrator password is set, the BIOS setup options can only be modified after providing the correct password.

The following rules and dependencies apply to the Administrator Password:

- The administrator password cannot be set if the computer and/or internal hard drive passwords are previously set.
 - The administrator password can be used in place of the computer and/or internal hard drive passwords.
-

Table 37. System setup options—Passwords menu (continued)

Passwords

- When set, the administrator password must be provided during a firmware update.
- Clearing the administrator password also clears the computer password (if set).

Dell Technologies recommends using an administrator password to prevent unauthorized changes to the BIOS setup options.

System Password

The System Password prevents the computer from booting to an operating system without entering the correct password.

The following rules and dependencies apply when the System Password is used:

- The computer shuts down when idle for approximately 10 minutes at the computer password prompt.
- The computer shuts down after three incorrect attempts to enter the computer password.
- The computer shuts down when the **Esc** key is pressed at the System Password prompt.
- The computer password is not prompted when the computer resumes from standby mode.

Dell Technologies recommends using the computer password in situations where it is likely that a computer may be lost or stolen.

M.2 PCIe SSD-0

The M.2 PCIe SSD password can be set to prevent unauthorized access of the data stored on the solid-state drive. The computer prompts for the solid-state drive password during boot in order to unlock the drive. A password-secured solid-state drive stays locked even when removed from the computer or placed into another computer. It prevents an attacker from accessing data on the drive without authorization.

The following rules and dependencies apply when this option is used:

- The solid-state drive password option cannot be accessed when a solid-state drive is disabled in the BIOS setup.
- The computer shuts down when idle for approximately 10 minutes at the solid-state drive password prompt.
- The computer shuts down after three incorrect attempts to enter the solid-state drive password and treats the solid-state drive as not available.
- The solid-state drive does not accept password unlock attempts after five incorrect attempts to enter the solid-state drive password from the BIOS Setup. The solid-state drive password must be reset for the new password unlock attempts.
- The computer treats the solid-state drive as not available when the **Esc** key is pressed at the solid-state drive password prompt.
- The solid-state drive password is not prompted when the computer resumes from standby mode. When the solid-state drive is unlocked by the user before the computer goes into standby mode, it remains unlocked after the computer resumes from standby mode.
- If the computer and solid-state drive passwords are set to the same value, the solid-state drive unlocks after the correct computer password is entered.

Dell Technologies recommends using a solid-state drive password to protect unauthorized data access.

Owner Password

The Owner Password is typically used when a computer is loaned or leased, and the end user sets their own computer or hard drive password. The Owner Password can provide override access to unlock the computer when it is returned. The Owner Password cannot be set using BIOS Setup. System lessors are given a tool which enables them to configure the Owner Password.

The following rules and dependencies apply when the Owner Password is used:

Table 37. System setup options—Passwords menu (continued)

Passwords

- The owner password cannot be set when the administrator password is already set.
- The owner password can be used in place of the administrator, computer, or hard drive passwords.

i **NOTE:** The hard drive password must have been set on the computer with the owner password.

Dell Technologies recommends that only computer lessors use the owner password.

Strong Password

The Strong Password feature enforces stricter rules for administrator, owner, and computer passwords.

When enabled, the following rules are enforced:

- The minimum length of the password is set to eight characters.
- The password is required to include at least one upper case and one lower case character.

i **NOTE:** These requirements do not affect the hard drive password.

By default, the **Strong Password** option is enabled.

For additional security, Dell Technologies recommends keeping the **Strong Password** option enabled as it requires passwords to be more complex.

Password Configuration

The Password configuration page includes several options for changing the requirements of BIOS passwords. You can modify the minimum and maximum length of the passwords and require passwords to contain certain character classes (upper case, lower case, digit, special character).

Dell Technologies recommends setting the minimum password length to at least eight characters.

Password Bypass

The **Password Bypass** option allows the computer to reboot from the operating system without entering the computer or hard drive password. If the computer has already booted to the operating system, it is presumed that the user has already entered the correct computer or hard drive password.

i **NOTE:** This option does not remove the requirement to enter the password after shutting down.

By default, the **Password Bypass** option is enabled.

For additional security, Dell Technologies recommends keeping the **Password Bypass** option enabled.

Password Changes

Allow Non-Admin Password Changes

The **Allow Non-Admin Password Changes** option in BIOS setup allows an end user to set or change the computer or hard drive passwords without entering the administrator password. This gives an administrator control over the BIOS settings but enables an end user to provide their own password.

By default, the **Allow Non-Admin Password Changes** option is disabled.

For additional security, Dell Technologies recommends keeping the **Allow Non-Admin Password Changes** option disabled.

Non-Admin Setup Changes

The **Non-Admin Setup Changes** option allows an end user to configure the wireless devices without requiring the administrator password.

By default, the **Non-Admin Setup Changes** option is disabled.

For additional security, Dell Technologies recommends keeping the **Non-Admin Setup Changes** option disabled.

Table 37. System setup options—Passwords menu (continued)

Passwords

Admin Setup Lockout The **Admin Setup Lockout** option prevents an end user from even viewing the BIOS setup configuration without first entering the administrator password (if set).
By default, the **Admin Setup Lockout** option is disabled.
For additional security, Dell Technologies recommends keeping the **Admin Setup Lockout** option disabled.

Master Password Lockout

Enable Master Password Lockout The Master Password Lockout setting allows you to disable the Recovery Password feature. If the computer, administrator, or hard drive password is forgotten, the computer becomes unusable.
NOTE: When the owner password is set, the Master Password Lockout option is not available.
NOTE: When an internal hard drive password is set, it must first be cleared before Master Password Lockout can be changed.
By default, the **Enable Master Password Lockout** option is disabled.
Dell does not recommend enabling the **Master Password Lockout** unless you have implemented your own password recovery computer.

Table 38. System setup options—Update, Recovery menu

Update, Recovery

UEFI Capsule Firmware Updates

Enable UEFI Capsule Firmware Updates Enables or disables BIOS updates through UEFI capsule update packages.
NOTE: Disabling this option blocks the BIOS updates from services such as Microsoft Windows Update and Linux Vendor Firmware Service (LVFS).
By default, the **Enable UEFI Capsule Firmware Updates** option is enabled.

BIOS Recovery from Hard Drive

Enables or disables the user to recover from certain corrupted BIOS conditions from a recovery file on the user primary hard drive or an external USB key.
By default, the **BIOS Recovery from Hard Drive** option is enabled.
NOTE: BIOS Recovery from Hard Drive is not available for self-encrypting drives (SED).
NOTE: BIOS recovery is designed to fix the main BIOS block and cannot work if the Boot Block is damaged. In addition, this feature cannot work in the event of EC corruption, ME corruption, or a hardware issue. The recovery image must exist on an unencrypted partition on the drive.

BIOS Downgrade

Allow BIOS Downgrade Controls flashing of the computer firmware to previous revisions.
By default, the **Allow BIOS Downgrade** option is enabled.

SupportAssist OS Recovery

Enables or disables the boot flow for SupportAssist OS Recovery tool if certain computer errors.
By default, the **SupportAssist OS Recovery** option is enabled.

BIOSConnect

Enables or disables cloud Service operating system recovery if the main operating system fails to boot with the number of failures equal to or greater than the value specified by the Auto operating system Recovery Threshold setup option and the local Service operating system does not boot or is not installed.
By default, the **BIOSConnect** option is enabled.

Table 38. System setup options—Update, Recovery menu (continued)

Update, Recovery

Dell Auto OS Recovery Threshold	Allows you to control the automatic boot flow for SupportAssist System Resolution Console and for Dell Operating System Recovery Tool. By default, the Dell Auto OS Recovery Threshold value is set to 2.
--	---

Table 39. System setup options—System Management menu

System Management

Service Tag	Displays the Service Tag of the computer.
Asset Tag	Creates a computer Asset Tag that can be used by an IT administrator to uniquely identify a particular computer.  NOTE: Once set in the BIOS setup menu, the Asset Tag cannot be changed.
AC Behavior	
Wake on AC	Enables or disables the computer to turn on and go to boot when AC power is supplied to the computer. By default, the Wake on AC option is disabled.
Wake on LAN	Enables or disables the computer to turn on by a special LAN signal. By default, the Wake on LAN option is disabled.
Auto On Time	Enable to set the computer to turn on automatically every day or on a preselected date and time. This option can be configured only if the Auto On Time is set to Everyday, Weekdays, or Selected Days. By default, the Auto On Time option is disabled.
First Power On Date	
Set Ownership Date	Set the ownership date. By default, the Set Ownership Date option is disabled.
Diagnostics	
OS Agent Requests	Enable or disable the scheduling of onboard diagnostics.

Table 40. System setup options—Keyboard menu

Keyboard

Enable Numlock	Enables or disables the Numlock function when the system boots. By default, the Enable Numlock option is enabled.
Fn Lock Options	Enables or disables the Fn Lock option. By default, the Fn Lock Options is enabled.
Lock Mode	By default, the Lock Mode Secondary option is enabled. With this option, the F1-F12 keys scan the code for their secondary functions.
RGB Per Key Keyboard Language	Select the language that matches the keyboard installed on the system. Default: English US  CAUTION: Selecting the incorrect language may cause the keyboard to malfunction.
RGB Per Key Keyboard Color	Select the keyboard color that matches the keyboard installed on the system. Default: Dark

Table 40. System setup options—Keyboard menu (continued)

Keyboard

 **CAUTION:** Selecting the incorrect language may cause the keyboard lighting to malfunction.

Table 41. System setup options—Pre-boot Behavior menu

Preboot Behavior

Adapter Warnings

Enable Dock Warning Messages	Enables the warning messages during boot when the adapters with less power capacity are detected. By default, the Enable Dock Warning Messages option is enabled.
------------------------------	---

Warnings and Errors

Enables or disables the action to be taken when a warning or error is encountered.

By default, the **Prompt on Warnings and Errors** option is selected. Stop, prompt, and wait for user input when warnings or errors are detected.
 **NOTE:** Errors deemed critical to the operation of the computer hardware stop the functioning of the computer.

USB-C Warnings

Enable Dock Warning Messages	Enables the warning messages during boot when the USB-C adapters with less power capacity are detected. By default, the Enable Dock Warning Messages option is enabled.
------------------------------	---

Extend BIOS POST Time

Sets the BIOS POST (Power-On Self-Test) load time.

By default, the **0 seconds** option is selected.

Sign of Life

Early Audio Beep	Display Logo Sign of Life. By default, the Early Audio Beep option is enabled.
Early Logo Display	Display Logo Sign of Life. By default, the Early Logo Display option is enabled.
Early Keyboard Backlight	Keyboard Backlight Sign of Life. By default, the Early Keyboard Backlight option is enabled.

Table 42. System setup options—Virtualization menu

Virtualization Support

Intel Virtualization Technology

Enable Intel Virtualization Technology (VT)	When enabled, the computer can run a Virtual Machine Monitor (VMM). By default, the Enable Intel Virtualization Technology (VT) option is enabled.
---	--

VT for Direct I/O

Enable Intel VT for Direct I/O	When enabled, the computer can perform Virtualization Technology for Direct I/O (VT-d). VT-d is an Intel method that provides virtualization for memory map I/O. By default, the Enable Intel VT for Direct I/O option is enabled.
--------------------------------	--

DMA Protection

Enable Pre-Boot DMA Support	Allows you to control the Pre-Boot DMA protection for both internal and external ports. This option does not directly enable DMA protection in the operating system.
-----------------------------	--

Table 42. System setup options—Virtualization menu (continued)

Virtualization Support

	<p>NOTE: This option is not available when the virtualization setting for IOMMU is disabled (VT-d/AMD Vi).</p> <p>By default, the Enable Pre-Boot DMA Support option is enabled.</p> <p>For additional security, Dell Technologies recommends keeping the Enable Pre-Boot DMA Support option enabled.</p> <p>NOTE: This option is provided only for compatibility purposes, since some older hardware is not DMA capable.</p>
Enable OS Kernel DMA Support	<p>Allows you to control the Kernel DMA protection for both internal and external ports. This option does not directly enable DMA protection in the operating system. For operating systems that support DMA protection, this setting indicates to the operating system that the BIOS supports the feature.</p> <p>NOTE: This option is not available when the virtualization setting for IOMMU is disabled (VT-d/AMD Vi).</p> <p>By default, the Enable OS Kernel DMA Support option is enabled.</p> <p>NOTE: This option is provided only for compatibility purposes, since some older hardware is not DMA capable.</p>

Table 43. System setup options—Performance menu

Performance

Multi-Core Support	<p>Enables to change the number of CPU cores available to the operating system. The default value is set to the maximum number of cores.</p> <p>By default, the All Active option is selected.</p>
Active Efficient Cores (E-Cores) Select	<p>Enables to change the number of CPU E-Cores available to the operating system. . The default value is set to the maximum number of cores.</p> <p>By default, the All Cores option is selected.</p>
Intel SpeedStep	
Enable Intel SpeedStep Technology	<p>Enables the computer to dynamically adjust processor voltage and core frequency, decreasing average power consumption and heat production.</p> <p>By default, the Enable Intel SpeedStep Technology option is enabled.</p>
Enable Adaptive C-States for Discrete Graphics	<p>Enables or disables the ability of the computer to dynamically detect high-usage of a discrete graphics and adjust system parameters for higher performance sung the time. to enter and exit low-power state. When disabled, it disables all C-states. When enabled, it enables all C-states that the chipset or platform allows.</p> <p>By default, the Enable Adaptive C-States for Discrete Graphics is enabled.</p>
Intel Turbo Boost Technology	
Enable Intel Turbo Boost Technology	<p>Enables the Intel TurboBoost mode of the processor. When enabled, the Intel TurboBoost driver increases the performance of the CPU or graphics processor.</p> <p>By default, the Enable Intel Turbo Boost Technology option is enabled.</p>
Intel Hyper-Threading Technology	
Enable Intel Hyper-Threading Technology	<p>Enables the Intel Hyper-Threading mode of the processor. When enabled, the Intel Hyper-Threading increases the efficiency of the processor resources when multiple threads run on each core.</p> <p>By default, the Intel Hyper-Threading Technology option is enabled.</p>
Dynamic Tuning: Machine Learning	

Table 43. System setup options—Performance menu (continued)

Performance

Enable Dynamic Tuning: Machine Learning	Enables or disables operating system capability to enhance power tuning capabilities depending on the detected workloads. i NOTE: This option is available for development only and is not customer visible. By default, the Enable Dynamic Tuning: Machine Learning option is enabled.
TCC Activation Offset	Allows you to adjust CPU's Toc offset. By default, the TCC Activation Offset is set to 0.

Table 44. System setup options—System Logs menu

System Logs

BIOS Event Log

Clear BIOS Event Log	Allows you to select option to keep or clear BIOS events logs. By default, the Keep Log option is selected.
----------------------	---

Thermal Event Log

Clear Thermal Event Log	Allows you to select option to keep or clear Thermal events logs. By default, the Keep Log option is selected.
-------------------------	--

Power Event Log

Clear Power Event Log	Allows you to select option to keep or clear Power events logs. By default, the Keep Log option is selected.
-----------------------	--

Updating the BIOS

Updating the BIOS in Windows

Steps

1. Go to [Dell Support Site](#).
2. Click **Product support**. In the **Search support** box, enter the Service Tag of your computer, and then click **Search**.
i **NOTE:** If you do not have the Service Tag, use the SupportAssist feature to automatically identify your computer. You can also use the product ID or manually browse for your computer model.
3. Click **Drivers & Downloads**. Expand **Find drivers**.
4. Select the operating system installed on your computer.
5. In the **Category** drop-down list, select **BIOS**.
6. Select the latest version of BIOS, and click **Download** to download the BIOS file for your computer.
7. After the download is complete, browse the folder where you saved the BIOS update file.
8. Double-click the BIOS update file icon and follow the on-screen instructions.
For more information about how to update the system BIOS, search in the Knowledge Base Resource at [Dell Support Site](#).

Updating the BIOS using the USB drive in Windows

Steps

1. Follow the procedure from step 1 to step 6 in [Updating the BIOS in Windows](#) to download the latest BIOS setup program file.
2. Create a bootable USB drive. For more information, search the Knowledge Base Resource at [Dell Support Site](#).

3. Copy the BIOS setup program file to the bootable USB drive.
4. Connect the bootable USB drive to the computer that needs the BIOS update.
5. Restart the computer and press **F12** .
6. Select the USB drive from the **One Time Boot Menu**.
7. Type the BIOS setup program filename and press **Enter**.
The **BIOS Update Utility** appears.
8. Follow the on-screen instructions to complete the BIOS update.

Updating the BIOS from the F12 One Time Boot menu

Update your computer BIOS using the BIOS update.exe file that is copied to a FAT32 USB drive and booting from the F12 **One Time Boot** menu.

About this task

BIOS Update

You can run the BIOS update file from Windows using a bootable USB drive or you can also update the BIOS from the F12 **One Time Boot** menu on the computer.

Most of the Dell computers built after 2012 have this capability, and you can confirm by booting your computer to the F12 **One Time Boot** Menu to see if BIOS FLASH UPDATE is listed as a boot option for your computer. If the option is listed, then the BIOS supports this BIOS update option.

 **NOTE:** Only computers with the BIOS Flash Update option in the F12 **One Time Boot** menu can use this function.

Updating from the One Time Boot menu

To update your BIOS from the F12 **One Time Boot** menu, you need the following:

- USB drive formatted to the FAT32 file system (key does not have to be bootable)
- BIOS executable file that you downloaded from the Dell Support website and copied to the root of the USB drive
- AC power adapter that is connected to the computer
- Functional computer battery to flash the BIOS

Perform the following steps to perform the BIOS update flash process from the F12 menu:

 **CAUTION:** Do not turn off the computer during the BIOS update process. The computer may not boot if you turn off your computer.

Steps

1. From a turn off state, insert the USB drive where you copied the flash into a USB port of the computer.
2. Turn on the computer and press F12 to access the **One Time Boot** Menu, select BIOS Update using the mouse or arrow keys then press Enter.
The flash BIOS menu is displayed.
3. Click **Flash from file**.
4. Select an external USB device.
5. Select the file and double-click the flash target file, and then click **Submit**.
6. Click **Update BIOS**. The computer restarts to flash the BIOS.
7. The computer will restart after the BIOS update is completed.

System and setup password

Table 45. System and setup password

Password type	Description
System password	Password that you must enter to log in to your system.
Setup password	Password that you must enter to access and make changes to the BIOS settings of your computer.

You can create a system password and a setup password to secure your computer.

 **CAUTION:** The password features provide a basic level of security for the data on your computer.

 **CAUTION:** Anyone can access the data that is stored on your computer, when not locked and left unattended.

 **NOTE:** System and setup password feature is disabled.

Assigning a System Setup password

Prerequisites

You can assign a new System or Admin Password only when the status is in **Not Set**.

About this task

To enter BIOS System Setup, press F2 immediately after a power-on or reboot.

Steps

1. In the **System BIOS** or **System Setup** screen, select **Security** and press Enter.
The **Security** screen is visible.
2. Select **System/Admin Password** and create a password in the **Enter the new password** field.
Use the following guidelines to assign the system password:
 - A password can have up to 32 characters.
 - At least one special character: "(! " # \$ % & ' * + , - . / : ; < = > ? @ [\] ^ _ ` { | })"
 - Numbers 0 to 9.
 - Upper case letters from A to Z.
 - Lower case letters from a to z.
3. Type the system password that you entered earlier in the **Confirm new password** field and click **OK**.
4. Press Esc and save the changes as prompted by the message.
5. Press Y to save the changes.
The computer restarts.

Deleting or changing an existing system setup password

Prerequisites

Ensure that the **Password Status** is Unlocked (in the System Setup) before attempting to delete or change the existing System and/or Setup password. You cannot delete or change an existing System or Setup password, if the **Password Status** is Locked.

About this task

To enter the System Setup, press F2 immediately after a power-on or reboot.

Steps

1. In the **System BIOS** or **System Setup** screen, select **System Security** and press Enter.
The **System Security** screen is displayed.
2. In the **System Security** screen, verify that the Password Status is **Unlocked**.
3. Select **System Password**, update, or delete the existing system password, and press Enter or Tab.
4. Select **Setup Password**, update, or delete the existing setup password, and press Enter or Tab.
 **NOTE:** If you change the System and/or Setup password, reenter the new password when prompted. If you delete the System and/or Setup password, confirm the deletion when prompted.
5. Press Esc. A message prompts you to save the changes.
6. Press Y to save the changes and exit from System Setup.

The computer restarts.

Clearing BIOS (System Setup) and System passwords

About this task

To clear the computer or BIOS passwords, contact Dell technical support as described at [Contact Support at Dell Support Site](#).

 **NOTE:** For information about how to reset Windows or application passwords, see the documentation accompanying Windows or your application.

Troubleshooting

Handling swollen rechargeable Li-ion batteries

Like most laptops, Dell laptops use Lithium-ion batteries. One type of Lithium-ion battery is the rechargeable Li-ion battery. Rechargeable Li-ion batteries have increased in popularity in recent years and have become standard in the electronics industry due to customer preferences for a slim form factor (especially with newer ultra-thin laptops) and long battery life. Inherent to rechargeable Li-ion battery technology is the potential for swelling of the battery cells.

A swollen battery may impact the performance of the laptop. To prevent possible further damage to the device enclosure or internal components leading to malfunction, discontinue the use of the laptop and discharge it by disconnecting the AC adapter and letting the battery drain.

Swollen batteries should not be used and should be replaced and disposed of properly. We recommend contacting Dell product support for options to replace a swollen battery under the terms of the applicable warranty or service contract, including options for replacement by a Dell authorized service technician.

The guidelines for handling and replacing rechargeable Li-ion batteries are as follows:

- Exercise caution when handling rechargeable Li-ion batteries.
- Discharge the battery before removing it from the system. To discharge the battery, unplug the AC adapter from the system and operate the system only on battery power. When the system will no longer turn on when the power button is pressed, the battery is fully discharged.
- Do not crush, drop, mutilate, or penetrate the battery with foreign objects.
- Do not expose the battery to high temperatures, or disassemble battery packs and cells.
- Do not apply pressure to the surface of the battery.
- Do not bend the battery.
- Do not use tools of any type to pry on or against the battery.
- If a battery gets stuck in a device as a result of swelling, do not try to free it as puncturing, bending, or crushing a battery can be dangerous.
- Do not attempt to reassemble a damaged or swollen battery into a laptop.
- Swollen batteries that are covered under warranty should be returned to Dell in an approved shipping container (provided by Dell)—this is to comply with transportation regulations. Swollen batteries that are not covered under warranty should be disposed of at an approved recycling center. Contact Dell product support at [Dell Support Site](#) for assistance and further instructions.
- Using a non-Dell or incompatible battery may increase the risk of fire or explosion. Replace the battery only with a compatible battery purchased from Dell that is designed to work with your Dell computer. Do not use a battery from other computers with your computer. Always purchase genuine batteries from [Dell Site](#) or otherwise directly from Dell.

Rechargeable Li-ion batteries can swell for various reasons such as age, number of charge cycles, or exposure to high heat. For more information about how to improve the performance and lifespan of the laptop battery and to minimize the possibility of occurrence of the issue, search Dell Laptop Battery in the Knowledge Base Resource at [Dell Support Site](#).

Locate the Service Tag or Express Service Code of your Dell computer

Your Dell computer is uniquely identified with a Service Tag or Express Service Code. To view relevant support resources for your Dell computer, we recommend entering the Service Tag or Express Service Code at [Dell Support Site](#).

For more information about how to find the Service Tag for your computer, see [Instructions on how to find your Service Tag or Serial Number](#).

Built-in self-test (BIST)

M-BIST

M-BIST (Built In Self-Test) is the system board built-in self-test diagnostics tool that improves the diagnostics accuracy of system board Embedded Controller (EC) failures.

NOTE: M-BIST can be manually initiated before Power On Self-Test (POST).

How to run M-BIST

NOTE: M-BIST must be initiated on the computer from a power-off state that is either connected to AC power or with a battery only.

1. Press and hold both the **M** key on the keyboard and the **power button** to initiate M-BIST.
2. The battery indicator LED may exhibit two states:
 - a. OFF: No fault was detected with the system board.
 - b. AMBER: Amber indicates a problem with the system board.
3. If there is a failure with the system board, the battery status LED flashes one of the following error codes for 30 seconds:

Table 46. LED error codes

Blinking Pattern		Possible Problem
Amber	White	
2	1	CPU Failure
2	8	LCD Power Rail Failure
1	1	TPM Detection Failure
2	4	Memory/RAM failure

4. If there is no failure with the system board, the LCD cycles through the solid color screens that are described in the LCD-BIST section for 30 seconds and then turn off.

LCD Power rail test (L-BIST)

L-BIST is an enhancement to the single LED error code diagnostics and is automatically initiated during POST. L-BIST will check the LCD power rail. If there is no power being supplied to the LCD (that is if the L-BIST circuit fails), the battery status LED flashes either an error code [2,8] or an error code [2,7].

NOTE: If L-BIST fails, LCD-BIST cannot function as no power will be supplied to the LCD.

How to invoke the L-BIST Test:

1. Press the power button to start the computer.
2. If the computer does not start up normally, look at the battery status LED:
 - If the battery status LED flashes an error code [2,7], the display cable may not be connected properly.
 - If the battery status LED flashes an error code [2,8], there is a failure on the LCD power rail of the system board, hence there is no power that is supplied to the LCD.
3. For cases, when a [2,7] error code is shown, check to see if the display cable is properly connected.
4. For cases when a [2,8] error code is shown, replace the system board.

LCD Built-in Self-Test (BIST)

Dell laptops have a built-in diagnostic tool that helps you determine if the screen abnormality you are experiencing is an inherent problem with the LCD (screen) of the Dell laptop or with the video card (GPU) and computer settings.

When you notice screen abnormalities like flickering, distortion, clarity issues, fuzzy or blurry image, horizontal or vertical lines, color fade and so on, it is always a good practice to isolate the LCD (screen) by running the Built-In Self-Test (BIST).

How to invoke the LCD BIST Test

1. Power off the Dell laptop.
2. Disconnect any peripherals that are connected to the laptop. Connect only the AC adapter (charger) to the laptop.
3. Ensure that the LCD (screen) is clean (no dust particles on the surface of the screen).
4. Press and hold the **D** key and **Power on** the laptop to enter LCD built-in self-test (BIST) mode. Continue to hold the D key until the computer boots up.
5. The screen displays solid colors and change colors on the entire screen to white, black, red, green, and blue twice.
6. Then it displays the colors white, black, and red.
7. Carefully inspect the screen for abnormalities (any lines, fuzzy color, or distortion on the screen).
8. At the end of the last solid color (red), the computer shuts down.

NOTE: Dell SupportAssist Preboot diagnostics upon launch initiates an LCD BIST first, expecting a user intervention to confirm functionality of the LCD.

System-diagnostic lights

Power and battery-status light

The power and battery status light indicates the power and battery status of the computer. These are the power states:

Solid white: Power adapter is connected and the battery has more than 5% charge.

Amber: Computer is running on battery and the battery has less than 5% charge.

Off:

- Power adapter is connected, and the battery is fully charged.
- Computer is running on battery, and the battery has more than 5% charge.
- Computer is in sleep state, hibernation, or turned off.

The power and battery-status light may also blink red or blue according to pre-defined "beep codes" indicating various failures.

For example, the power and battery-status light blinks red two times followed by a pause, and then blinks blue three times followed by a pause. This 2,3 pattern continues until the computer is turned off, indicating no memory or RAM is detected.

The following table shows different power and battery-status light patterns and associated problems.

NOTE: The following diagnostic light codes and recommended solutions are intended for Dell service technicians to troubleshoot problems. You should only perform troubleshooting and repairs as authorized or directed by the Dell technical support team. Damage due to servicing that is not authorized by Dell is not covered by your warranty.

Table 47. Diagnostic-light LED codes

Diagnostic light codes	Problem description
1,1	TPM detection failure
1,2	Unrecoverable SPI Flash Failure
1,3	Short in hinge cable tripped OCP1 (camera or touchpad)
1,4	Short in hinge cable tripped OCP2 (display)
1,5	EC unable to program i-Fuse
1,6	Generic catch-all for ungraceful EC code flow errors

Table 47. Diagnostic-light LED codes (continued)

Diagnostic light codes	Problem description
2,1	Processor failure
2,2	System board: BIOS or ROM (Read-Only Memory) failure
2,3	No memory or RAM (Random-Access Memory) detected
2,4	Memory or RAM (Random-Access Memory) failure
2,5	Invalid memory installed
2,6	System-board or chipset error
2,7	Display failure - SBIOS message
2,8	Display failure - EC detection of power rail failure
3,1	RTC power failure
3,2	PCI, video card or chip failure
3,3	Recovery image not found
3,4	Recovery image found but invalid
3,5	Power-rail failure
3,6	System BIOS Flash incomplete
3,7	Management Engine (ME) error

SupportAssist diagnostics

About this task

The SupportAssist diagnostics (previously known as ePSA diagnostics) performs a complete check of your hardware. The SupportAssist diagnostics is embedded in the BIOS and is launched by it internally. The SupportAssist diagnostics provides a set of options for particular devices or device groups. It allows you to:

- Run tests automatically or in an interactive mode.
- Repeat tests
- Display or save test results
- Run thorough tests to introduce additional test options and provide extra information about the failed device(s)
- View status messages that indicate if the tests are completed successfully
- View error messages that indicate if problems were encountered during the test

 **NOTE:** Some tests are meant for specific devices and require user interaction. Ensure that you are present in front of the computer when the diagnostic tests are performed.

For more information, see [SupportAssist Pre-Boot System Performance Check](#).

Recovering the operating system

When your computer is unable to boot to the operating system even after repeated attempts, it automatically starts Dell SupportAssist OS Recovery.

Dell SupportAssist OS Recovery is a stand-alone tool that is preinstalled in all Dell computers that are installed with the Windows operating system. It consists of tools to diagnose and troubleshoot issues that may occur before your computer boots to the operating system. It enables you to diagnose hardware issues, repair your computer, back up your files, or restore your computer to its factory state.

You can also download it from the Dell Support website to troubleshoot and fix your computer when it fails to boot into their primary operating system due to software or hardware failures.

For more information about the Dell SupportAssist OS Recovery, see *Dell SupportAssist OS Recovery User's Guide at Serviceability Tools at the Dell Support Site*. Click **SupportAssist** and then, click **SupportAssist OS Recovery**.

Backup media and recovery options

It is recommended to create a recovery drive to troubleshoot and fix problems that may occur with Windows. Dell proposes multiple options for recovering the Windows operating system on your Dell computer. For more information, see [Dell Windows Backup Media and Recovery Options](#).

Wi-Fi power cycle

About this task

If your computer is unable to access the Internet due to Wi-Fi connectivity issues a Wi-Fi power cycle procedure may be performed. The following procedure provides the instructions on how to conduct a Wi-Fi power cycle:

 **NOTE:** Some Internet Service Providers (ISPs) provide a modem or router combo device.

Steps

1. Turn off your computer.
2. Turn off the modem.
3. Turn off the wireless router.
4. Wait for 30 seconds.
5. Turn on the wireless router.
6. Turn on the modem.
7. Turn on your computer.

Drain residual flea power (perform hard reset)

About this task

Flea power is the residual static electricity that remains in the computer even after it has been powered off and the battery is removed.

For your safety, and to protect the sensitive electronic components in your computer, you are requested to drain residual flea power before removing or replacing any components in your computer.

Draining residual flea power, also known as a performing a "hard reset," is also a common troubleshooting step if your computer does not turn on or boot into the operating system.

Perform the following steps to drain the residual flea power:

Steps

1. Turn off your computer.
2. Disconnect the power adapter from your computer.
3. Remove the base cover.
4. Remove the battery.



CAUTION: The battery is a Field Replaceable Unit (FRU) and the removal/installation is intended for authorized service technicians only.

5. Press and hold the power button for 20 seconds to drain the flea power.
6. Install the battery.
7. Install the base cover.
8. Connect the power adapter to your computer.
9. Turn on your computer.



 **NOTE:** For more information about performing a hard reset, search in the Knowledge Base Resource at [Dell Support Site](#).

Getting help and contacting Alienware

Self-help resources

You can get information and help on Alienware products and services using these online self-help resources:

Table 48. Alienware products and online self-help resources

Self-help resources	Resource location
Information about Alienware products and services	Alienware Support Site
My Dell app	
Tips	
Contact Support	In Windows search, type Contact Support , and press Enter .
Online help for operating system	Windows Support Site
Access top solutions, diagnostics, drivers and downloads, and learn more about your computer through videos, manuals, and documents.	Your Alienware computer is uniquely identified by a Service Tag or Express Service Code. To view relevant support resources for your Dell computer, enter the Service Tag or Express Service Code at Dell Support Site . For more information about how to find the Service Tag for your computer, see Instructions on how to find your Service Tag or Serial Number .
Videos providing step-by-step instructions to service your computer	Alienware Support Channel

Contacting Alienware

To contact Alienware for sales, technical support, or customer service issues, see [Alienware Support Site](#).

 **NOTE:** Availability of the services may vary depending on the country or region, and product.

 **NOTE:** If you do not have an active Internet connection, you can find contact information about your purchase invoice, packing slip, bill, or Dell product catalog.