

Alienware x16 R2

Owner's Manual

Notes, cautions, and warnings

 **NOTE:** A NOTE indicates important information that helps you make better use of your product.

 **CAUTION:** A CAUTION indicates either potential damage to hardware or loss of data and tells you how to avoid the problem.

 **WARNING:** A WARNING indicates a potential for property damage, personal injury, or death.

Contents

Chapter 1: Views of Alienware x16 R2	7
Top	7
Front	8
Back	9
Bottom	10
Service Tag	10
Chapter 2: Set up your Alienware x16 R2	12
Chapter 3: Specifications of Alienware x16 R2	13
Dimensions and weight	13
Processor	13
Chipset	14
Operating system	14
Memory	15
External ports and slots	15
Internal slots	15
Wireless module	16
Audio	16
Storage	17
Media-card reader	17
Keyboard	17
Keyboard shortcuts	18
Camera	19
Touchpad	20
Power adapter	20
Battery	21
Display	22
GPU—Integrated	23
GPU—Discrete	23
External display support	23
Operating and storage environment	24
Dell low blue light display	24
Chapter 4: Alienware Command Center	25
Chapter 5: Working inside your computer	26
Safety instructions	26
Before working inside your computer	26
Safety precautions	27
Electrostatic discharge—ESD protection	27
ESD Field Service kit	28
Transporting sensitive components	29
After working inside your computer	29

Recommended tools.....	29
Screw list.....	29
Major components of Alienware x16 R2.....	31
Chapter 6: Removing and installing Customer Replaceable Units (CRUs).....	34
Base cover.....	34
Removing the base cover.....	34
Installing the base cover.....	37
Solid state drive.....	39
Removing the M.2 2230 solid state drive (SSD).....	39
Installing the M.2 2230 solid state drive (SSD).....	40
Removing the M.2 2280 solid state drive (SSD).....	41
Installing the M.2 2280 solid state drive (SSD).....	42
Solid state drive bracket.....	44
Removing the solid state drive bracket.....	44
Installing the solid state drive bracket.....	45
Wireless card.....	48
Removing the wireless card.....	48
Installing the wireless card.....	50
Rear I/O-cover.....	53
Removing the rear I/O-cover.....	53
Installing the rear I/O-cover.....	54
Chapter 7: Removing and installing Field Replaceable Units (FRUs).....	56
Battery.....	56
Rechargeable Li-ion battery precautions.....	56
Removing the battery.....	56
Installing the battery.....	58
Battery cable.....	59
Removing the battery cable.....	59
Installing the battery cable.....	60
Touchpad.....	61
Removing the touchpad.....	61
Installing the touchpad.....	64
Headset port.....	66
Removing the headset port.....	66
Installing the headset port.....	67
microSD-card reader.....	68
Removing the microSD-card reader.....	68
Installing the microSD-card reader.....	70
Keyboard-controller board.....	71
Removing the keyboard-controller board.....	71
Installing the keyboard-controller board.....	73
Display assembly.....	74
Removing the display assembly.....	74
Installing the display assembly.....	78
Antennas.....	82
Removing the antennas.....	82
Installing the antennas.....	83

Processor fan.....	84
Removing the processor fan.....	84
Installing the processor fan.....	85
Graphics-card fan.....	86
Removing the graphics-card fan.....	86
Installing the graphics-card fan.....	87
Power-adapter port.....	88
Removing the power-adapter port.....	88
Installing the power-adapter port.....	89
System board.....	90
Removing the system board.....	90
Installing the system board.....	97
Fan and heat-sink assembly.....	102
Removing the fan and heat-sink assembly.....	102
Installing the fan and heat-sink assembly.....	105
WLAN board.....	107
Removing the I/O board.....	107
Installing the I/O board.....	108
Power button.....	110
Removing the power button.....	110
Installing the power button.....	111
Palm-rest and keyboard assembly.....	112
Removing the palm-rest and keyboard assembly.....	112
Installing the palm-rest and keyboard assembly.....	114
Chapter 8: BIOS Setup.....	117
Entering BIOS Setup program.....	117
Navigation keys.....	117
F12 One Time Boot menu.....	117
System setup options.....	118
Updating the BIOS.....	131
Updating the BIOS in Windows.....	131
Updating the BIOS using the USB drive in Windows.....	131
Updating the BIOS in Linux and Ubuntu.....	132
Updating the BIOS from the One-Time boot menu.....	132
System and setup password.....	132
Assigning a System Setup password.....	133
Deleting or changing an existing system password or setup password.....	133
Clearing system and setup passwords.....	133
Chapter 9: Troubleshooting.....	134
Handling swollen rechargeable Li-ion batteries.....	134
Locating the Service Tag or Express Service Code of your Dell computer	134
Dell SupportAssist Pre-boot System Performance Check diagnostics.....	135
Running the SupportAssist Pre-Boot System Performance Check.....	135
Built-in self-test (BIST).....	135
(Motherboard Built-In Self-Test) M-BIST.....	135
Logical Built-in Self-test (L-BIST).....	136
LCD Built-in Self-Test (LCD-BIST).....	136

System-diagnostic lights..... 137
Network power cycle..... 138
Drain flea power (perform hard reset)..... 139

Chapter 10: Getting help and contacting Alienware..... 140

Views of Alienware x16 R2

Top



Figure 1. Top view

1. Power button

Press to turn on the computer if it is turned off, in sleep state, or in hibernate state.

Press to put the computer in sleep state if it is turned on.

When the computer is turned on, press the power button to put the computer into sleep state; press and hold the power button for four seconds to force shut-down the computer.

NOTE: You can customize the power-button behavior in Windows.

2. Right speaker

Provides audio output.

3. Right-click button

Press to right-click.

4. Left-click button

Press to left-click.

5. Touchpad

Move your finger on the touchpad to move the mouse pointer. Tap to left-click and two fingers tap to right-click.

NOTE: AlienFX lighting is available only on configurations that are shipped with an NVIDIA GeForce RTX 4080 or higher graphics card.

6. Left speaker

Provides audio output.

Front

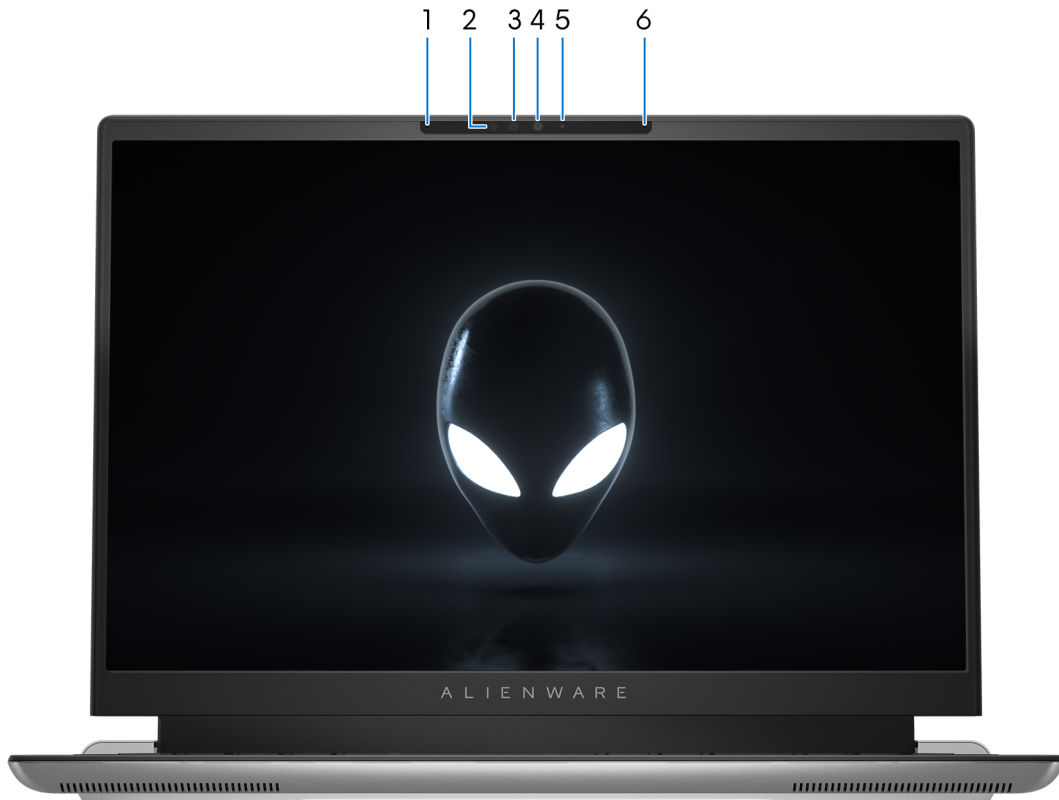

Figure 2. Front view

1. Left microphone

Provides digital sound input for audio recording and voice calls.

2. Infrared emitter

Emits infrared light, which enables the infrared camera to sense and track motion.

3. Infrared camera (optional)

Enhances security when paired with Windows Hello face authentication.

4. Camera

Enables you to video chat, capture photos, and record videos.

5. Camera-status light

Turns on when the camera is in use.

6. Right microphone

Provides digital sound input for audio recording and voice calls.

Back

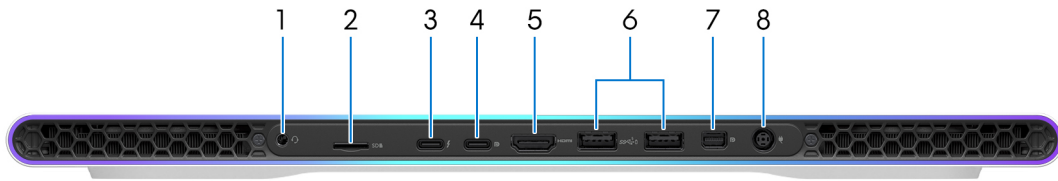

Figure 3. Back view

1. Headset port

Connect headphones or a headset (headphone and microphone combo).

2. microSD card slot

Reads from and writes to the microSD card. The computer supports the following card types:

- microSecure Digital (microSD)
- microSecure Digital High Capacity (microSDHC)
- microSecure Digital Extended Capacity (microSDXC)

3. Thunderbolt 4.0 port with Power Delivery and DisplayPort

Supports USB4, DisplayPort 2.1, Thunderbolt 4 and also enables you to connect to an external display using a display adapter. Provides data transfer rates of up to 40 Gbps for USB4 and Thunderbolt 4.

NOTE: A USB Type-C to DisplayPort adapter (sold separately) is required to connect a DisplayPort device.

NOTE: USB4 is backward compatible with USB 3.2, USB 2.0, and Thunderbolt 3.

NOTE: Thunderbolt 4 supports two 4K displays or one 8K display.

4. USB 3.2 Gen 2 (Type-C) port with DisplayPort

Connect devices such as external storage devices, printers, and external displays. It provides a data transfer rate of up to 10 Gbps and supports DisplayPort 1.4. It also enables you to connect an external display using a display adapter.

NOTE: A USB Type-C to DisplayPort adapter (sold separately) is required to connect a DisplayPort device.

5. HDMI 2.1 port

Connect to a TV, external display or another HDMI-in enabled device. It provides video and audio output.

6. USB 3.2 Gen 1 port with PowerShare (2)

Connect devices such as external storage devices and printers.

Provides data transfer speeds up to 5 Gbps. PowerShare enables you to charge your USB devices even when your computer is turned off.

NOTE: If your computer is turned off or in a hibernate state, you must connect the power adapter to charge your devices using the PowerShare port. You must enable this feature in the BIOS setup program.

NOTE: Certain USB devices may not charge when the computer is turned off or in a sleep state. In such cases, turn on the computer to charge the device.

7. Mini DisplayPort

Connect to a TV or another DisplayPort-in enabled device. Mini DisplayPort provides video and audio output.

8. Power-adapter port

Connect a power adapter to provide power to your computer and charge the battery.

Bottom

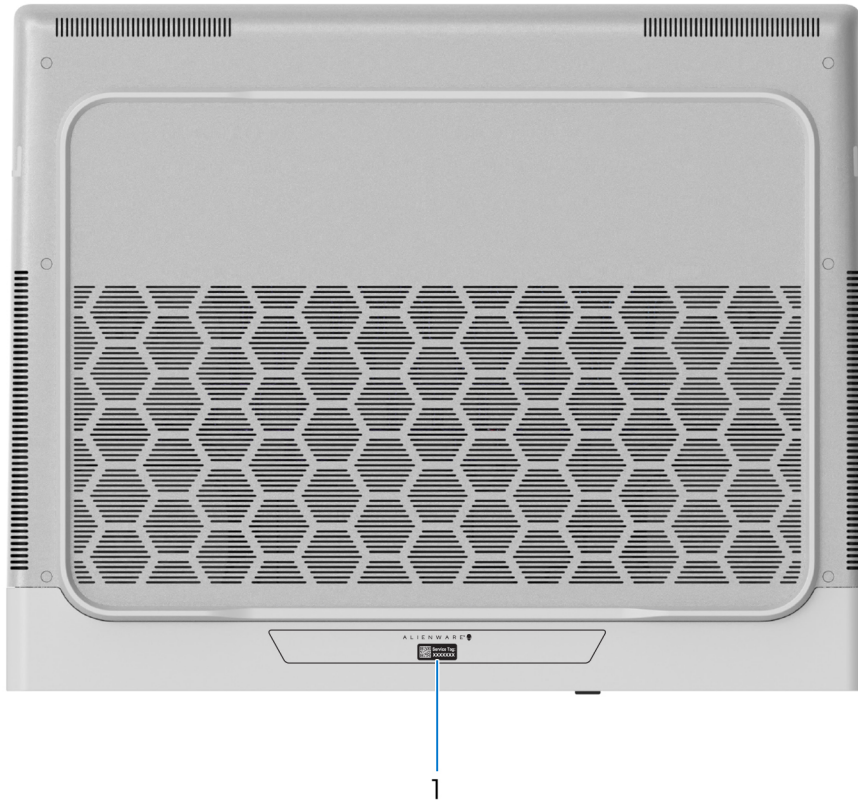

Figure 4. Bottom view

1. Service Tag label

The Service Tag is a unique alphanumeric identifier that enables Dell service technicians to identify the hardware components in your computer and access warranty information.

Service Tag

The service tag is a unique alphanumeric identifier that allows Dell service technicians to identify the hardware components in your computer and access warranty information.

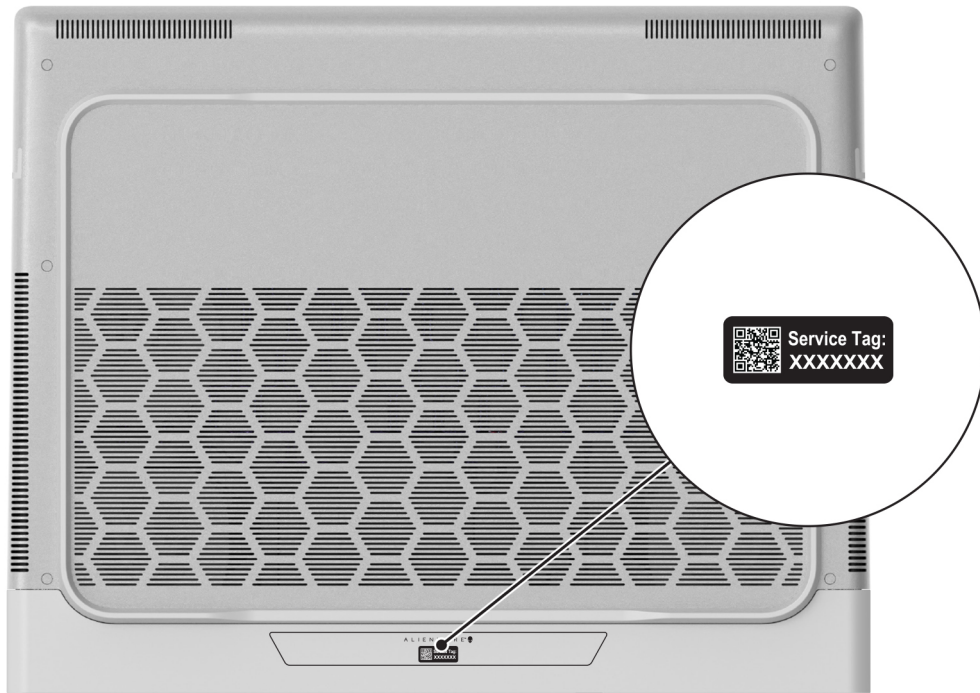

Figure 5. Service tag

Set up your Alienware x16 R2

About this task

i **NOTE:** The images in this document may differ from your computer depending on the configuration you ordered.

Steps

1. Connect the power adapter and press the power button.



Figure 6. Connect the power adapter and press the power button

2. Connect the USB Type-C Ethernet dongle to the Thunderbolt 4 port of your computer for wired network (optional).

i **NOTE:** Depending on the configuration ordered, this computer may be shipped with a USB Type-C Ethernet dongle.



Figure 7. Connect the USB Type-C Ethernet dongle

Specifications of Alienware x16 R2

Dimensions and weight

The following table lists the height, width, depth, and weight of your Alienware x16 R2.

Table 1. Dimensions and weight

Description	Values
Height:	
Front height	18.57 mm (0.73 in.)
Rear height	18.57 mm (0.73 in.)
Width	364.81 mm (14.36 in.)
Depth	289.98 mm (11.42 in.)
Weight  NOTE: The weight of your computer depends on the configuration that is offered.	<ul style="list-style-type: none">• 2.72 kg (6 lb)—maximum• 2.66 kg (5.86 lb)—minimum

Processor

The following table lists the details of the processors that are supported for your Alienware x16 R2.

Table 2. Processor

Description	Option one	Option two
Processor type	Intel Core Ultra 7 processor 155H	Intel Core Ultra 9 processor 185H
Processor wattage	45	45
Processor total core count	14	14
Performance-cores	6	6
Efficient-cores	8	8
Processor total thread counts <i>i</i> NOTE: Intel Hyper-Threading Technology is only available on Performance-cores.	20	20
Processor speed	Up to 4.80 GHz	Up to 5.10 GHz
Performance-cores frequency		
Processor base frequency	1.40 GHz	2.30 GHz
Maximum turbo frequency	4.80 GHz	5.10 GHz
Efficient-cores frequency		
Processor base frequency	1.40 GHz	1.80 GHz
Maximum turbo frequency	3.80 GHz	3.80 GHz
Processor cache	24 MB	24 MB
Integrated graphics	Intel Arc Graphics	Intel Arc Graphics

Chipset

The following table lists the details of the chipset that is supported in your Alienware x16 R2.

Table 3. Chipset

Description	Values
Chipset	Integrated in the processor
Processor	<ul style="list-style-type: none"> Intel Core Ultra 7 processor 155H Intel Core Ultra 9 processor 185H
DRAM bus width	128
Flash EPROM	48 MB
PCIe bus	Gen4

Operating system

Your Alienware x16 R2 supports the following operating systems:

- Windows 11 Home (64-bit)
- Windows 11 Pro (64-bit)

Memory

The following table lists the memory specifications of your Alienware x16 R2.

Table 4. Memory specifications

Description	Values
Memory slots	Onboard memory
Memory type	Dual-channel LPDDR5x
Memory speed	7467 MT/s
Maximum memory configuration	32 GB
Minimum memory configuration	16 GB
Memory configurations supported	<ul style="list-style-type: none"> • 32 GB LPDDR5x at 7467 MT/s • 16 GB LPDDR5x at 7467 MT/s

External ports and slots

The following table lists the external ports and slots on your Alienware x16 R2.

Table 5. External ports and slots

Description	Values
USB ports	<ul style="list-style-type: none"> • Two USB 3.2 Gen 1 ports with PowerShare • One USB-C 3.2 Gen 2 port with DisplayPort • One Thunderbolt 4 port with Power Delivery and DisplayPort
Audio port	One headset port - 3.5 mm Universal audio jack
Video port(s)	<ul style="list-style-type: none"> • One HDMI 2.1 port • One mini Displayport
Media-card reader	One microSD-card slot
Power-adaptor port	One 7.40 mm x 5.10 mm DC-in
Security-cable slot	Not supported

Internal slots

The following table lists the internal slots of your Alienware x16 R2.

Table 6. Internal slots

Description	Values
M.2	<ul style="list-style-type: none"> • One M.2 2230 slot for WiFi and Bluetooth combo card

Table 6. Internal slots

Description	Values
	<ul style="list-style-type: none"> Two M.2 2230/2280 slots for solid state drive <p>NOTE: To learn more about the features of different types of M.2 cards, search in the Knowledge Base Resource at Dell Support Site.</p>

Wireless module

The following table lists the Wireless Local Area Network (WLAN) module that is supported on your Alienware x16 R2.

Table 7. Wireless module specifications

Description	Values
Model number	Killer BE1750x
Transfer rate	Up to 5760 Mbps
Frequency bands supported	2.4 GHz/5 GHz/6 GHz
Wireless standards	<ul style="list-style-type: none"> WiFi 802.11a/b/g Wi-Fi 4 (WiFi 802.11n) Wi-Fi 5 (WiFi 802.11ac) Wi-Fi 6E (WiFi 802.11ax)
Encryption	<ul style="list-style-type: none"> 64-bit/128-bit WEP AES-CCMP TKIP
Bluetooth wireless card	Bluetooth 5.4

Audio

The following table lists the audio specifications of your Alienware x16 R2.

Table 8. Audio specifications

Description	Values
Audio controller	Realtek ALC3281
Stereo conversion	Supported
Internal audio interface	High definition audio interface
External audio interface	Universal Audio Jack
Number of speakers	6
Internal-speaker amplifier	Not supported
External volume controls	Keyboard shortcut controls
Speaker output:	

Table 8. Audio specifications (continued)

Description		Values
	Average	2 W
	Peak	3 W
Microphone		Digital-array microphones in camera assembly

Storage

This section lists the storage options on your Alienware x16 R2.

Your Alienware x16 R2 supports two M.2 2230/2280 solid state drives. The primary drive of your Alienware x16 R2 is slot 1.

(i) NOTE: Computers that are shipped with NVIDIA GeForce RTX 4060/4070 graphics card support one M.2 2230 and one M.2 2280 solid state drive slot, whereas computers shipped with NVIDIA GeForce RTX 4080/4090 graphics card support two M.2 2280 solid state drive slots.

Table 9. Storage specifications

Storage type	Interface type	Capacity
Two M.2 2230/2280 solid state drives	PCIe NVMe Gen4 x4, up to 64 Gbps	Up to 4 TB

Media-card reader

The following table provides the specification of media cards supported by your Alienware x16 R2.

Table 10. Media-card reader specifications

Description	Values
Media-card slot type	One microSD card slot
Media-cards supported	<ul style="list-style-type: none"> microSecure Digital (mSD) microSecure Digital High Capacity (mSDHC) microSecure Digital Extended Capacity (mSDXC)
(i) NOTE: The maximum capacity that is supported by the media-card reader varies depending on the standard of the media card that is installed on your computer.	

Keyboard

The following table lists the keyboard specifications of your Alienware x16 R2.

Table 11. Keyboard specifications

Description	Values
Keyboard type	<ul style="list-style-type: none"> Cherry mechanical backlit keyboard <p>(i) NOTE: The function row keys are not designed with mechanical switches.</p> <ul style="list-style-type: none"> RGB per-key backlit keyboard
Keyboard layout	QWERTY

Table 11. Keyboard specifications (continued)

Description	Values
Number of keys	<ul style="list-style-type: none"> English US, English International, Canada Bilingual MUI, Korean: 85 keys German, UK, French European: 86 keys Japanese: 89 keys
Keyboard size	X=19.05 mm key pitch Y=19.05 mm key pitch
Keyboard shortcuts	<p>Some keys on your keyboard have two symbols on them. These keys can be used to type alternate characters or to perform secondary functions. To type the alternate character, press Shift and the desired key. To perform secondary functions, press Fn and the desired key.</p> <p>NOTE: You can define the primary behavior of the function keys (F1–F12) changing Function Key Behavior in the BIOS setup program.</p> <p>NOTE: If Copilot in Windows is not available on your computer, pressing the Copilot key launches Windows search. For more information about Copilot in Windows, search in the Knowledge Base Resource at the Dell Support site.</p>

Keyboard shortcuts

NOTE: Keyboard characters may differ depending on the keyboard language configuration. Keys that are used for shortcuts remain the same across all language configurations.

Some keys on your keyboard have two symbols on them. These keys can be used to type alternate characters or to perform secondary functions. The symbol that is shown on the lower part of the key is the character that is typed out when the key is pressed. If you press shift and the key, the symbol that is shown on the upper part of the key is typed out. For example, if you press **2**, 2 is typed out; if you press **Shift + 2**, @ is typed out.

The keys F1–F12 at the top row of the keyboard are function keys for multimedia control, as indicated by the icon at the bottom of the key. Press the function key to invoke the task represented by the icon. For example, pressing F1 disable or enable performance boost (see the table below).

However, if the function keys F1–F12 are needed for specific software applications, multimedia functionality can be disabled by pressing **fn + Esc**. Later, multimedia control can be invoked by pressing **fn** and the respective function key. For example, disable or enable performance boost by pressing **fn + F1**.

NOTE: You can also define the primary behavior of the function keys (F1–F12) by changing **Function Key Behavior** in BIOS setup program.

Table 12. List of keyboard shortcuts

















Keys	Description
 + 	Disable or enable Performance Boost
 + 	Adjust keyboard backlight brightness
 + 	Switch to external display
 + 	Open Quick Settings

Table 12. List of keyboard shortcuts (continued)

Keys	Description
	Decrease display brightness
	Increase display brightness
	Disable or enable touchpad





Your computer comes with preprogrammable macro keys that enable you to perform multiple actions with a single key press.

Table 13. List of Macro keys

Keys	Description
	Macro keys ⓘ NOTE: You can configure modes and assign multiple tasks for the macro keys on the keyboard.
	
	
	
	

Your computer comes with dedicated keys that enable you to control specific features of the computer with a single key press.

Table 14. Keys to control specific features

Keys	Description
	Mute the microphone.
	Mute the speakers.
	Increase volume.
	Decrease volume.
	Disable or enable the Windows key which activates the Windows Start screen when the Windows key is pressed. ⓘ NOTE: Disabling the Windows key helps you to avoid accidental presses of the Windows key during gaming sessions.

Camera

The following table lists the camera specifications of your Alienware x16 R2.

Table 15. Camera specifications

Description	Values
Number of cameras	One

Table 15. Camera specifications (continued)

Description		Values
Camera type		FHD RGB+IR camera
Camera location		Front camera
Camera sensor type		CMOS sensor technology
Camera resolution:		
	Still image	2.07 megapixels
	Video	1920 x 1080 (FHD) at 30 fps
Infrared camera resolution:		
	Still image	0.23 megapixels
	Video	640 x 360 at 30 fps
Diagonal viewing angle:		
	Camera	80.2 degrees
	Infrared camera	86.6 degrees

Touchpad

The following table lists the touchpad specifications of your Alienware x16 R2.

Table 16. Touchpad specifications

Description		Values
Touchpad resolution:		
	Horizontal	1217
	Vertical	681
Touchpad dimensions:		
	Horizontal	112 mm (4.41 in.)
	Vertical	65 mm (2.56 in.)
Touchpad gestures		For more information about the touchpad gestures available on Windows, see the Microsoft Knowledge Base article at Microsoft Support Site .

Power adapter

The following table lists the power adapter specifications of your Alienware x16 R2.

Table 17. Power adapter specifications

Description	Option one	Option two	Option three
Type	SFF 240 W	SFF 330 W	SFF 360 W

Table 17. Power adapter specifications (continued)

Description	Option one	Option two	Option three
Power-adapter dimensions:			
Height	23 mm (0.91 in.)	25.40 mm (1 in.)	25.40 mm (1 in.)
Width	78 mm (3.07 in.)	86 mm (3.38 in.)	86 mm (3.38 in.)
Depth	152 mm (5.98 in.)	184 mm (7.24 in.)	189 mm (7.43 in.)
Input voltage	100 VAC–240 VAC	100 VAC–240 VAC	100 VAC–240 VAC
Input frequency	50 Hz–60 Hz	50 Hz–60 Hz	50 Hz–60 Hz
Input current (maximum)	3.50 A	4.40 A	4.80 A
Output current (continuous)	12.31 A	16.92 A	18.46 A
Rated output voltage	19.50 VDC	19.50 VDC	19.50 VDC
Temperature range:			
Operating	0°C to 40°C (32°F to 104°F)	0°C to 40°C (32°F to 104°F)	0°C to 40°C (32°F to 104°F)
Storage	-40°C to 70°C (-40°F to 158°F)	-40°C to 70°C (-40°F to 158°F)	-40°C to 70°C (-40°F to 158°F)
 CAUTION: Operating and storage temperature ranges may differ among components, so operating or storing the device outside these ranges may impact the performance of specific components.			

Battery

The following table lists the battery specifications of your Alienware x16 R2.

Table 18. Battery specifications

Description	Values
Battery type	6-cell 90 Whr Li-ion (polymer) battery
Battery voltage	11.40 VDC
Battery weight (maximum)	0.74 lb (0.33 kg)
Battery dimensions:	
Height	6.35 mm (0.25 in.)
Width	79.90 mm (3.15 in.)
Depth	334.50 mm (13.17 in.)
Temperature range:	
Operating	<ul style="list-style-type: none"> Charging: 0°C to 50°C (32°F to 122°F) Discharging: 0°C to 60°C (32°F to 140°F)
Storage	-20°C to 60°C (-4°F to 149°F)

Table 18. Battery specifications (continued)

Description	Values
Battery operating time	Varies depending on operating conditions and can significantly reduce under certain power-intensive conditions.
Battery charging time (approximate) NOTE: You can control the charging time, duration, start and end time, and so on, using the Dell Power Manager application. For more information about Dell Power Manager, search in the Knowledge Base Resource at Dell Support Site .	<ul style="list-style-type: none"> 0% to 35% in 20 minutes (ExpressCharge Boost) 0% to 80% in 1hr (Express charge) 0% to full in 2hr (Express charge) 0% to full in 3hr (Standard charge)
Coin-cell battery	Not supported
<p>CAUTION: Operating and storage temperature ranges may differ among components, so operating or storing the device outside these ranges may impact the performance of specific components.</p> <p>CAUTION: Dell Technologies recommends that you charge the battery regularly for optimal power consumption.</p>	

Display

The following table lists the display specifications of your Alienware x16 R2.

Table 19. Display specifications

Description	Option one	Option two
Display type	16 inch, Quad High Definition plus (QHD+)	16-inch, Full High Definition plus(FHD+)
Touch options	No	No
Display-panel technology	Wide Viewing Angle (WVA)	Wide Viewing Angle (WVA)
Display-panel dimensions (active area):		
	Height	215.42 mm (8.48 in.)
	Width	344.67 mm (13.56 in.)
	Diagonal	406.46 mm (16 in.)
Display-panel native resolution	2560 x 1600	1920 x 1200
Luminance (typical)	300 nits	300 nits
Megapixels	4.1 megapixels	2.3 megapixels
Color gamut	DCI P3 100% (typical)	DCI P3 100% (typical)
Pixels Per Inch (PPI)	188.7	188.7
Contrast ratio (typical)	1000:1	1000:1
Response time (typical)	<ul style="list-style-type: none"> 9 ms (typical), 12 ms (maximum) 3 ms gray to gray (with over drive) 7 ms gray to gray (without over drive) 	<ul style="list-style-type: none"> 9 ms (typical), 12 ms (maximum) 3 ms gray to gray (with over drive) 7 ms gray to gray (without over drive)
Refresh rate	240 Hz	480 Hz

Table 19. Display specifications (continued)

Description	Option one	Option two
Horizontal view angle	+/- 85 degrees	+/- 85 degrees
Vertical view angle	+/- 85 degrees	+/- 85 degrees
Pixel pitch	0.134 mm	0.179 mm
Power consumption (maximum)	7.2 W	6.75 W
Anti-glare vs glossy finish	Anti-glare	Anti-glare

GPU—Integrated

The following table lists the specifications of the integrated Graphics Processing Unit (GPU) supported by your Alienware x16 R2.

Table 20. GPU—Integrated

Controller	Memory size	Processor
Intel Arc Graphics	Shared system memory	Intel Ultra 7/ Ultra 9

GPU—Discrete

The following table lists the specifications of the discrete Graphics Processing Unit (GPU) supported by your Alienware x16 R2.

Table 21. GPU—Discrete

Controller	Memory size	Memory type
NVIDIA GeForce RTX 4060	8 GB	GDDR6
NVIDIA GeForce RTX 4070	8 GB	GDDR6
NVIDIA GeForce RTX 4080	12 GB	GDDR6
NVIDIA GeForce RTX 4090	16 GB	GDDR6

External display support

The following table lists the external display support for your Alienware x16 R2.

Table 22. External display support

Graphics card	Supported external displays with laptop display enabled	Supported external displays with laptop display disabled
Intel Arc Graphics	2	2
NVIDIA GeForce RTX 4060	2	2
NVIDIA GeForce RTX 4070	2	2
NVIDIA GeForce RTX 4080	2	2
NVIDIA GeForce RTX 4090	2	2

Operating and storage environment

This table lists the operating and storage specifications of your Alienware x16 R2.

Airborne contaminant level: G1 as defined by ISA-S71.04-1985

Table 23. Computer environment

Description	Operating	Storage
Temperature range	0°C to 35°C (32°F to 95°F)	-40°C to 65°C (-40°F to 149°F)
Relative humidity (maximum)	10% to 90% (non-condensing)	0% to 95% (non-condensing)
Vibration (maximum)*	0.66 GRMS	1.30 GRMS
Shock (maximum)	110 G†	160 G†
Altitude range	-15.2 m to 3048 m (-49.87 ft to 10000 ft)	-15.2 m to 10668 m (-49.87 ft to 35000 ft)
 CAUTION: Operating and storage temperature ranges may differ among components, so operating or storing the device outside these ranges may impact the performance of specific components.		

* Measured using a random vibration spectrum that simulates the user environment.

† Measured using a 2 ms half-sine pulse.

Dell low blue light display

 **WARNING: Prolonged exposure to blue light from the display may lead to long-term effects such as eye strain, eye fatigue, or damage to the eyes.**

Blue light is a color in the light spectrum which has a short wavelength and high energy. Chronic exposure to blue light, particularly from digital sources may disrupt sleep patterns and cause long-term effects such as eye strain, eye fatigue, or damage to the eyes.

The display on this computer is designed to minimize blue light and complies with TÜV Rheinland's requirement for low blue light displays.

Low blue light mode is enabled at the factory, so no further configuration is necessary.

To reduce the risk of eye strain, it is also recommended that you:

- Position the display at a comfortable viewing distance between 20 and 28 inches (50 cm and 70 cm) from your eyes.
- Blink frequently to moisten your eyes, wet your eyes with water, or apply suitable eye drops.
- Take an extended break for 20 minutes every two hours.
- Look away from your display, and gaze at a distant object at 20 ft (609.60 cm) away for at least 20 seconds during each break.

Alienware Command Center

Alienware Command Center (AWCC) provides a single interface to customize and enhance the gaming experience. The AWCC dashboard displays most recently played or added games, and provides game-specific information, themes, profiles, and access to computer settings. You can quickly access settings such as game-specific profiles and themes, lighting, macros, and audio that are critical to the gaming experience.

AWCC also supports AlienFX 2.0. AlienFX enables you to create, assign, and share game-specific lighting maps to enhance the gaming experience. It also enables you to create your own customized lighting effects and apply them to the computer or attached peripherals. AWCC embeds Peripheral Controls to ensure a unified experience and the ability to link these settings to your computer or game.

- Keyboard
- Alien head power button
- Alien head LED on the back of the display

 **NOTE:** Information about the location of AlienFX lighting zones on your computer is available in AWCC.

AWCC supports the following features:









- FX: Create and manage the AlienFX zones.
- Fusion: Fusion includes the ability to adjust game-specific Power Management, Sound Management, and Thermal Management features.
- Peripheral Management: Peripheral Management enables peripherals to appear in and be managed in Alienware Command Center. Supports key peripheral settings and associates with other functions such as profiles, macros, AlienFX, and game library.

AWCC also supports Sound Management, Thermal Controls, CPU, GPU, and Memory (RAM) monitoring. For more information about AWCC, see the *Alienware Command Center Online Help* or search in the Knowledge Base Resource at [Dell Support Site](#).

Working inside your computer



Safety instructions

Use the following safety guidelines to protect your computer from potential damage and to ensure your personal safety. Unless otherwise noted, each procedure in this document assumes that you have read the safety information that shipped with your computer.

-  **WARNING:** Before working inside your computer, read the safety information that is shipped with your computer. For more safety best practices, see [Dell Regulatory Compliance Home Page](#).
-  **WARNING:** Disconnect your computer from all power sources before opening the computer cover or panels. After you finish working inside the computer, replace all covers, panels, and screws before connecting your computer to an electrical outlet.
-  **CAUTION:** To avoid damaging the computer, ensure that the work surface is flat, dry, and clean.
-  **CAUTION:** You should only perform troubleshooting and repairs as authorized or directed by the Dell technical support team. Damage due to servicing that is not authorized by Dell is not covered by your warranty. See the safety instructions that is shipped with the product or at [Dell Regulatory Compliance Home Page](#).
-  **CAUTION:** Before touching anything inside your computer, ground yourself by touching an unpainted metal surface, such as the metal at the back of the computer. While you work, periodically touch an unpainted metal surface to dissipate static electricity which could harm internal components.
-  **CAUTION:** To avoid damaging the components and cards, handle them by their edges, and avoid touching the pins and the contacts.
-  **CAUTION:** When you disconnect a cable, pull it by its connector or its pull tab, not the cable itself. Some cables have connectors with locking tabs or thumbscrews that you must disengage before disconnecting the cable. When disconnecting cables, keep them evenly aligned to avoid bending the connector pins. When connecting cables, ensure that the connector on the cable is correctly oriented and aligned with the port.
-  **CAUTION:** Press and eject any installed card from the media-card reader.
-  **CAUTION:** Exercise caution when handling rechargeable Li-ion batteries in laptops. Swollen batteries should not be used and should be replaced and disposed properly.

Before working inside your computer

Steps

1. Save and close all open files and exit all open applications.
2. Shut down your computer. For Windows operating system, click **Start** >  **Power** > **Shut down**.
 -  **NOTE:** If you are using a different operating system, see the documentation of your operating system for shut-down instructions.
3. Disconnect your computer and all attached devices from their electrical outlets.
4. Disconnect all attached network devices and peripherals, such as keyboard, mouse, and monitor from your computer.
5. Remove any media card and optical disk from your computer, if applicable.
6. Enter the service mode, if you can turn on your computer.

Service Mode

Service Mode is used to cut off power, without disconnecting the battery cable from the system board prior to conducting repairs in the computer.

 **CAUTION:** If you are unable to turn on the computer to put it into Service Mode, or the computer does not support Service Mode, disconnect the battery cable. To disconnect the battery cable, follow the steps in [Removing the battery](#).

 **NOTE:** Ensure that your computer is shut down and the AC adapter is disconnected.

- a. Hold the key on the keyboard and press the power button for 3 seconds or until the Dell logo appears on the screen.
- b. Press any key to continue.
- c. If the AC adapter is not disconnected, a message prompting you to remove the AC adapter appears on the screen. Remove the AC adapter and then press any key to continue the **Service Mode** process. The **Service Mode** process automatically skips the following step if the **Owner Tag** of the computer is not set up in advance by the user.
- d. When the **ready-to-proceed** message appears on the screen, press any key to proceed. The computer emits three short beeps and shuts down immediately.
- e. Once the computer shuts down, it has successfully entered Service Mode.

 **NOTE:** If you are unable to turn on your computer or unable to enter Service Mode, skip this process.

Safety precautions

This section details the primary steps to be followed before performing any disassembly instructions.

Observe the following safety precautions before you perform any installation or break-fix procedures involving disassembly or reassembly:

- Turn off the computer and all attached peripherals.
- Disconnect the computer from AC power.
- Disconnect all network cables and peripherals from the computer.
- Use an ESD field service kit when working inside any notebook to avoid electrostatic discharge (ESD) damage.
- Place the removed component on an anti-static mat after removing it from the computer.
- Wear shoes with nonconductive rubber soles to reduce the chance of getting electrocuted.
- Unplugging, pressing, and holding the power button for 15 seconds should discharge residual power in the system board.

Standby power

Dell products with standby power must be unplugged before you open the back cover. Systems that are equipped with standby power are powered while turned off. The internal power enables the computer to be remotely turned on (Wake-on-LAN) and suspended into a sleep mode and has other advanced power management features.

Bonding

Bonding is a method for connecting two or more grounding conductors to the same electrical potential. This is done by using a field service electrostatic discharge (ESD) kit. When connecting a bonding wire, ensure that it is connected to bare metal and never to a painted or nonmetal surface. Ensure that the wrist strap is secure and in full contact with your skin. Remove all jewelry, watches, bracelets, or rings before grounding yourself and the equipment.

Electrostatic discharge—ESD protection

ESD is a major concern when you handle electronic components, especially sensitive components such as expansion cards, processors, memory modules, and system boards. A slight charge can damage circuits in ways that may not be obvious, such as intermittent problems or a shortened product life span. As the industry pushes for lower power requirements and increased density, ESD protection is an increasing concern.

Two recognized types of ESD damage are catastrophic and intermittent failures.

- **Catastrophic** – Catastrophic failures represent approximately 20 percent of ESD-related failures. The damage causes an immediate and complete loss of device functionality. An example of catastrophic failure is a memory module that has received a static shock and immediately generates a "No POST/No Video" symptom with a beep code that is emitted for missing or nonfunctional memory.
- **Intermittent** – Intermittent failures represent approximately 80 percent of ESD-related failures. The high rate of intermittent failures means that most of the time when damage occurs, it is not immediately recognizable. The memory module receives

a static shock, but the tracing is merely weakened and does not immediately produce outward symptoms that are related to the damage. The weakened trace may take weeks or months to melt, and in the meantime may cause degradation of memory integrity, intermittent memory errors, and so on.

Intermittent failures that are also called latent or "walking wounded" are difficult to detect and troubleshoot.

Perform the following steps to prevent ESD damage:

- Use a wired ESD wrist strap that is properly grounded. Wireless anti-static straps do not provide adequate protection. Touching the chassis before handling parts does not ensure adequate ESD protection on parts with increased sensitivity to ESD damage.
- Handle all static-sensitive components in a static-safe area. If possible, use anti-static floor pads and workbench pads.
- When unpacking a static-sensitive component from its shipping carton, do not remove the component from the anti-static packing material until you are ready to install the component. Before unwrapping the anti-static packaging, use the anti-static wrist strap to discharge the static electricity from your body. For more information about the wrist strap and ESD wrist strap tester, see [Components of an ESD Field Service Kit](#).
- Before transporting a static-sensitive component, place it in an anti-static container or packaging.

ESD Field Service kit

The unmonitored field service kit is the most commonly used service kit. Each Field Service kit includes three main components: anti-static mat, wrist strap, and bonding wire.

 **CAUTION: It is critical to keep ESD-sensitive devices away from internal parts that are insulated and often highly charged, such as plastic heat sink casings.**

Working Environment

Before deploying the ESD Field Service kit, assess the situation at the customer location. For example, deploying the kit for a server environment is different than for a desktop or laptop environment. Servers are typically installed in a rack within a data center; desktops or laptops are typically placed on office desks or cubicles. Always look for a large open flat work area that is free of clutter and large enough to deploy the ESD kit with additional space to accommodate the type of computer that is being repaired. The workspace should also be free of insulators that can cause an ESD event. On the work area, insulators such as styrofoam and other plastics should always be moved at least 12 inches or 30 centimeters away from sensitive parts before physically handling any hardware components.

ESD Packaging

All ESD-sensitive devices must be shipped and received in static-safe packaging. Metal, static-shielded bags are preferred. However, you should always return the damaged component using the same ESD bag and packaging that the new part arrived in. The ESD bag should be folded over and taped shut and all the same foam packing material should be used in the original box that the new part arrived in. ESD-sensitive devices should be removed from packaging only at an ESD-protected work surface, and parts should never be placed on top of the ESD bag because only the inside of the bag is shielded. Always place parts in your hand, on the anti-static mat, in the computer, or inside an ESD bag.

Components of an ESD Field Service kit

The components of an ESD Field Service kit are:

- **Anti-Static Mat** – The anti-static mat is dissipative and parts can be placed on it during service procedures. When using an anti-static mat, your wrist strap should be snug and the bonding wire should be connected to the anti-static mat and to any bare metal on the computer being worked on. Once deployed properly, service parts can be removed from the ESD bag and placed directly on the anti-static mat. ESD-sensitive items are safe in your hand, on the anti-static mat, in the computer, or inside an ESD bag.
- **Wrist Strap and Bonding Wire** – The wrist strap and bonding wire can be either directly connected between your wrist and bare metal on the hardware if the anti-static mat is not required, or connect to the anti-static mat to protect hardware that is temporarily placed on the mat. The physical connection of the wrist strap and bonding wire between your skin, the anti-static mat, and the hardware is known as bonding. Use only Field Service kits with a wrist strap, anti-static mat, and bonding wire. Never use wireless wrist straps. Always be cautious that the internal wires of a wrist strap are prone to damage from normal wear and tear, and must be checked regularly with a wrist strap tester in order to avoid accidental ESD hardware damage. It is recommended to test the wrist strap and bonding wire at least once per week.
- **ESD Wrist Strap Tester** – The wires inside an ESD strap are prone to damage over time. When using an unmonitored kit, it is a best practice to regularly test the strap prior to each service, and at a minimum, test once per week. A wrist strap tester is the best

method for doing this test. To perform the test, plug the bonding-wire of the wrist-strap into the tester while it is strapped to your wrist and push the button to test. A green LED is lit if the test is successful; a red LED is lit and an alarm sounds if the test fails.

NOTE: It is recommended to always use the traditional wired ESD grounding wrist strap and protective anti-static mat when servicing Dell products. In addition, it is critical to keep sensitive parts separate from all insulator parts while servicing the computer.

Transporting sensitive components

When transporting ESD sensitive components such as replacement parts or parts to be returned to Dell, it is critical to place these parts in anti-static bags for safe transport.

After working inside your computer

About this task

CAUTION: Leaving stray or loose screws inside your computer may severely damage your computer.

Steps

1. Replace all screws and ensure that no stray screws remain inside your computer.
2. Connect any external devices, peripherals, or cables you removed before working on your computer.
3. Replace any media cards, discs, or any other parts that you removed before working on your computer.
4. Connect your computer and all attached devices to their electrical outlets.
 - NOTE:** To exit service mode, ensure to connect the AC adapter to the power-adapter port on your computer.
5. Press the power button to turn on the computer. Your computer will automatically return to normal functioning mode.

Recommended tools

The procedures in this document may require the following tools:

- Phillips screwdriver #0
- Plastic scribe

Screw list

NOTE: When removing screws from a component, it is recommended to note the screw type and the quantity of screws, and then place them in a screw storage box. This is to ensure that the correct number of screws and correct screw type is restored when the component is replaced.

NOTE: Some computers have magnetic surfaces. Ensure that the screws are not left attached to such surfaces when replacing a component.

NOTE: Screw color may vary depending on the configuration ordered.

Table 24. Screw list

Component	Secured to	Screw type	Quantity	Screw image
Base cover	Palm-rest and keyboard assembly	M2.5x5	2	

Table 24. Screw list (continued)







Component	Secured to	Screw type	Quantity	Screw image
Base cover	Palm-rest and keyboard assembly	M2.5x5 (Captive screw)	4	
Battery	Palm-rest and keyboard assembly	M2x4	4	
Wireless-card thermal shield	Wireless card and palm-rest and keyboard assembly	M2x4	2	
Wireless-card bracket	Wireless card and palm-rest and keyboard assembly	M2x3	1	
Solid state drive thermal shield	Solid state drive and palm-rest and keyboard assembly	M2x4	1	
Solid state drive bracket	Palm-rest and keyboard assembly	M2x4	1	
Processor fan	Palm-rest and keyboard assembly	M2x4	2	
Graphics-card fan	Palm-rest and keyboard assembly	M2x4	2	
Rear I/O cover	Palm-rest and keyboard assembly	M2.5x5	2	
Antenna	Palm-rest and keyboard assembly	M1.6x3	4	
Left and right tron-light cables	Palm-rest and keyboard assembly	M1.6x3	4	
Power-adapter port bracket	Palm-rest and keyboard assembly	M2x2.5	2	
Headset port	Palm-rest and keyboard assembly	M1.6x3	1	
microSD-card reader	Palm-rest and keyboard assembly	M1.6x3	1	
Display assembly	Palm-rest and keyboard assembly	M2.5x4	8	
Display-cable holder	Palm-rest and keyboard assembly	M1.6x3	4	
Keyboard-controller board bracket	Palm-rest and keyboard assembly	M1.6x1.6	2	
Touchpad	Palm-rest and keyboard assembly	M1.6x1.8	9	
Display-cable bracket	System board and palm-rest and keyboard assembly	M2x2.5	2	

Table 24. Screw list (continued)

Component	Secured to	Screw type	Quantity	Screw image
System board	Palm-rest and keyboard assembly	M2x4	7	
Fan and heat-sink assembly	System board	M2x3	6	
I/O-board	Palm-rest and keyboard assembly	M2x2.5	4	
Power button	Palm-rest and keyboard assembly	M1.2x2	2	

Major components of Alienware x16 R2

The following image shows the major components of Alienware x16 R2.

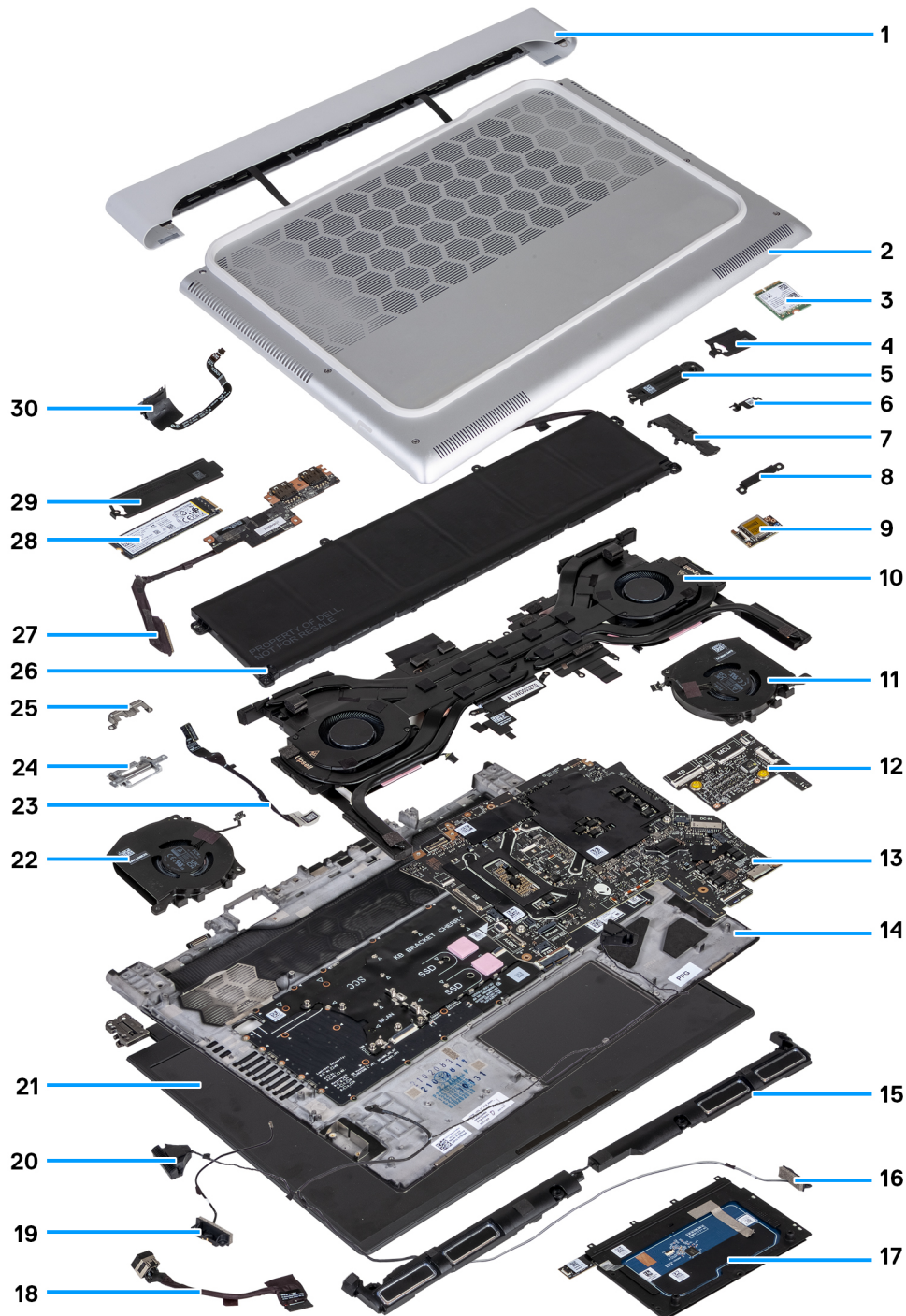

Figure 8. Exploded view of major components

1. Rear I/O-cover
2. Base cover
3. M.2 2330 solid state drive
4. M.2 2230 solid state drive thermal shield
5. Solid state drive mounting bracket
6. Wireless-card bracket
7. Solid state drive bracket
8. USB Type-C bracket
9. Wireless card
10. Fan and heat-sink assembly
11. Graphics-card fan

12. Keyboard-controller board
13. System board
14. Palm-rest and keyboard assembly
15. Speakers
16. Speaker cable
17. Touchpad
18. Power-adaptor port
19. Antenna
20. Tweeters
21. Display assembly
22. Processor fan
23. Headset port
24. Display-cable holder
25. Display-cable bracket
26. Battery
27. I/O board
28. M.2 2280 solid state drive
29. M.2 2280 solid state drive thermal shield
30. Power button

i **NOTE:** Dell provides a list of components and their part numbers for the original computer configuration purchased. These parts are available according to warranty coverage purchased by the customer. Contact your Dell sales representative for purchase options.

Removing and installing Customer Replaceable Units (CRUs)

The replaceable components in this chapter are Customer Replaceable Units (CRUs).

⚠ CAUTION: Customers can replace only the Customer Replaceable Units (CRUs) following the safety precautions and replacement procedures.

ⓘ NOTE: The images in this document may differ from your computer depending on the configuration you ordered.

Base cover

Removing the base cover

Prerequisites

1. Follow the procedure in [Before working inside your computer](#).

About this task

ⓘ NOTE: Before removing the base cover, ensure that there is no SD card that is installed in the SD card slot on your computer.

The following images indicate the location of the base cover and provide a visual representation of the removal procedure.



Figure 9. Loosen the captive screws

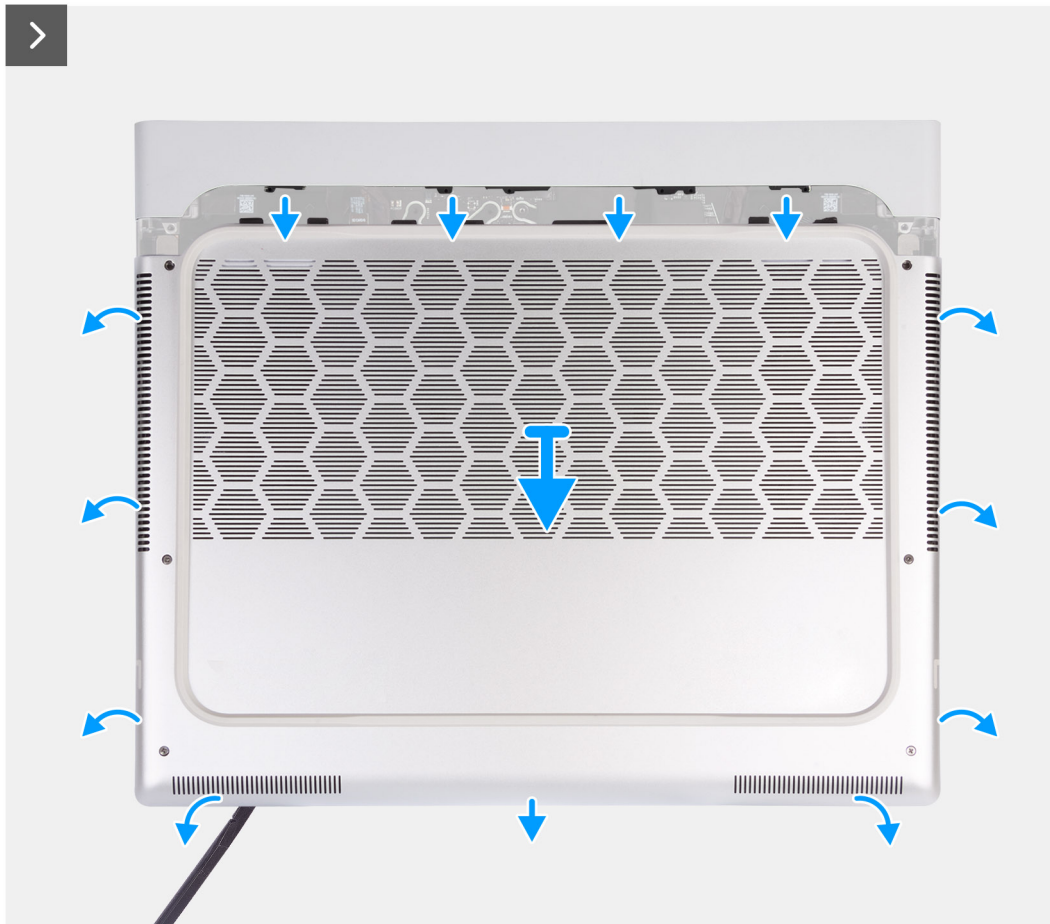

Figure 10. Removing the base cover

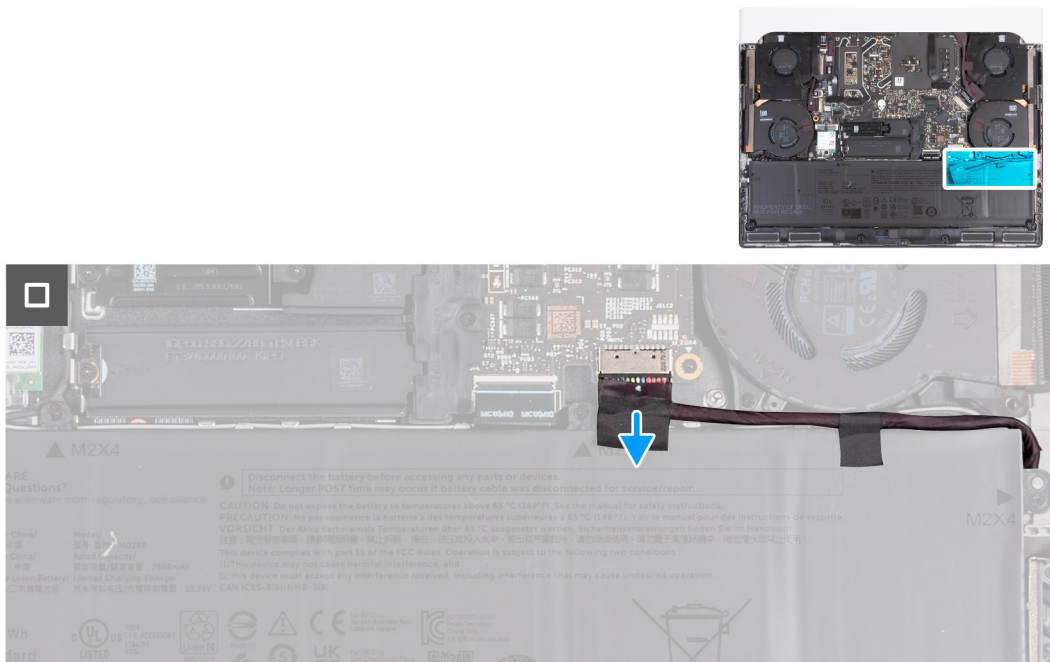

Figure 11. Disconnecting the battery cable

Steps

1. Remove the two screws (M2.5x5) that secure the base cover to the palm-rest and keyboard assembly.

2. Loosen the four captive screws (M2.5x5) that secure the base cover to the palm-rest and keyboard assembly.
3. Using a plastic scribe, pry the base cover from the gap that is created after loosening the captive screws in the bottom left and continue to work on the sides to open the base cover.
4. Lift the base cover by holding it in the center at the bottom and slide the base cover off the palm-rest and keyboard assembly.
5. Disconnect the battery cable from the system board.
6. Press and hold the power button for 20 seconds to ground the computer and drain the flea power.

Installing the base cover

Prerequisites

If you are replacing a component, remove the existing component before performing the installation process.

About this task

The following images indicate the location of the base cover and provide a visual representation of the installation procedure.



Figure 12. Connecting the battery cable

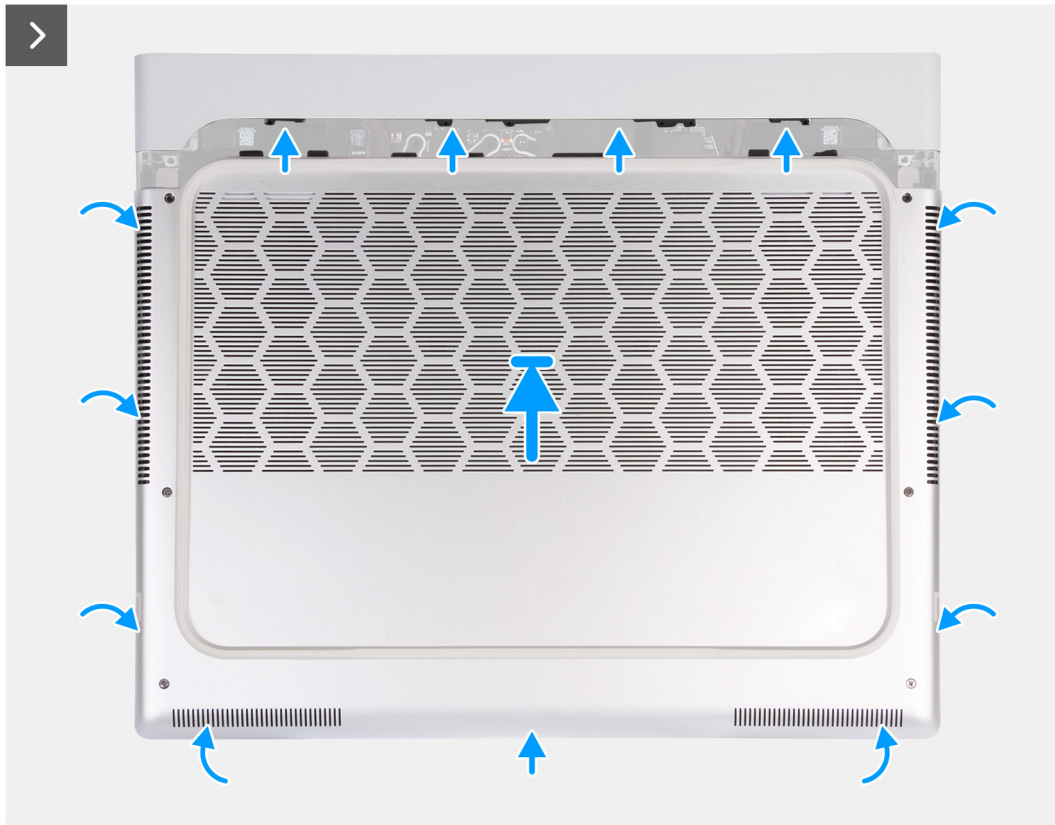

Figure 13. Placing the base cover

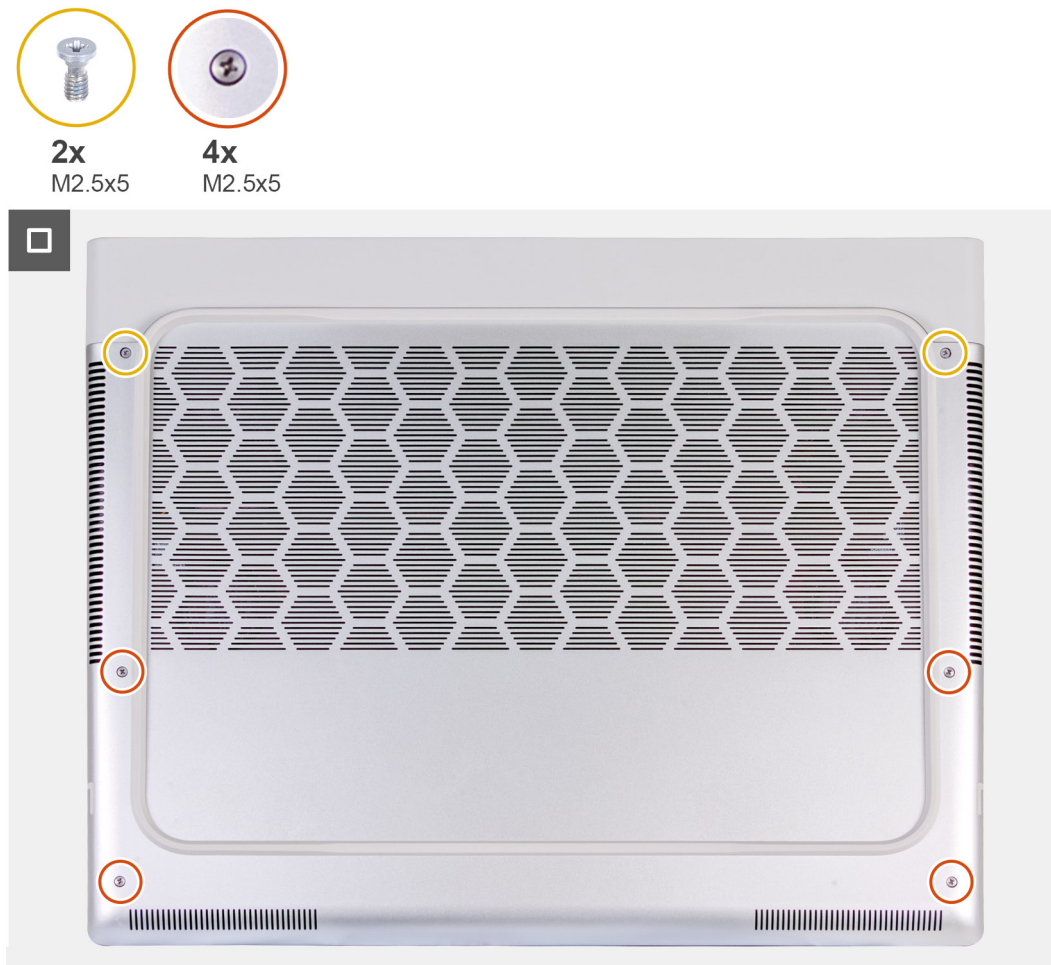

Figure 14. Tighten the captive screws

NOTE: If the battery is not a pre-requisite and if you have disconnected the battery cable, ensure to connect the battery cable. To connect the battery cable, follow step 1 and step 2 in the procedure.

Steps

1. Connect the battery cable to the system board.
2. Slide the tabs on the top of the base cover under the rear I/O-cover and snap the base cover to the palm-rest and keyboard assembly.
3. Tighten the four captive screws (M2.5x5) that secure the base cover to the palm-rest and keyboard assembly.
4. Replace the two screws (M2.5x5) that secure the base cover to the palm-rest and keyboard assembly.

Next steps

1. Follow the procedure in [After working inside your computer.](#)

Solid state drive

Removing the M.2 2230 solid state drive (SSD)

Prerequisites

1. Follow the procedure in [Before working inside your computer.](#)
2. Remove the [base cover.](#)

About this task

- NOTE:** The following procedure applies only to computers shipped with an M.2 2230 SSD.
- NOTE:** Computers that are shipped with NVIDIA GeForce RTX 4060/4070 graphics card support one M.2 2230 and one M.2 2280 solid state drive slot, whereas computers shipped with NVIDIA GeForce RTX 4080/4090 graphics card support two M.2 2280 solid state drive slots.

The following images indicate the location of the M.2 2230 SSD in SSD-2 and provide a visual representation of the removal procedure.

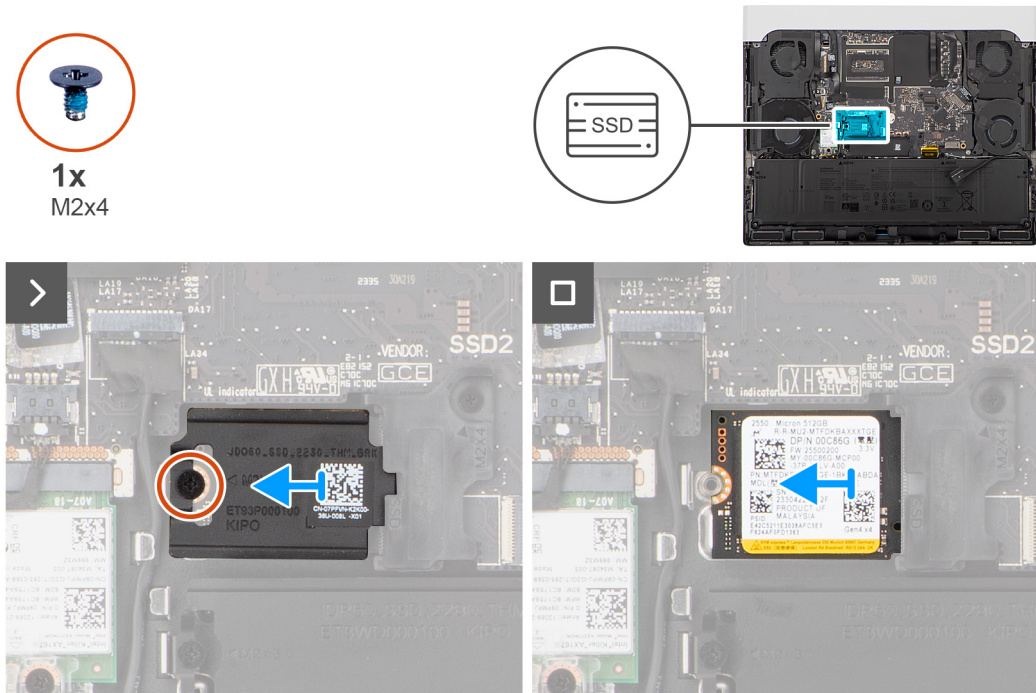

Figure 15. Removing the M.2 2230 SSD

Steps

1. Remove the screw (M2x4) that secures the SSD thermal shield to the SSD and palm-rest and keyboard assembly.
2. Remove the SSD thermal shield off the SSD.
3. Slide and remove the SSD from the SSD slot.

- NOTE:** Repeat step 1 to step 3 to remove the SSD on the SSD-1 slot on your computer.

Installing the M.2 2230 solid state drive (SSD)

Prerequisites

If you are replacing a component, remove the existing component before performing the installation process.

About this task

- NOTE:** The following procedure applies only to computers shipped with an M.2 2230 SSD.
- NOTE:** Computers that are shipped with NVIDIA GeForce RTX 4060/4070 graphics card support one M.2 2230 and one M.2 2280 solid state drive slot, whereas computers shipped with NVIDIA GeForce RTX 4080/4090 graphics card support two M.2 2280 solid state drive slots.

The following images indicate the location of the M.2 2230 SSD in SSD-2 and provide a visual representation of the installation procedure.

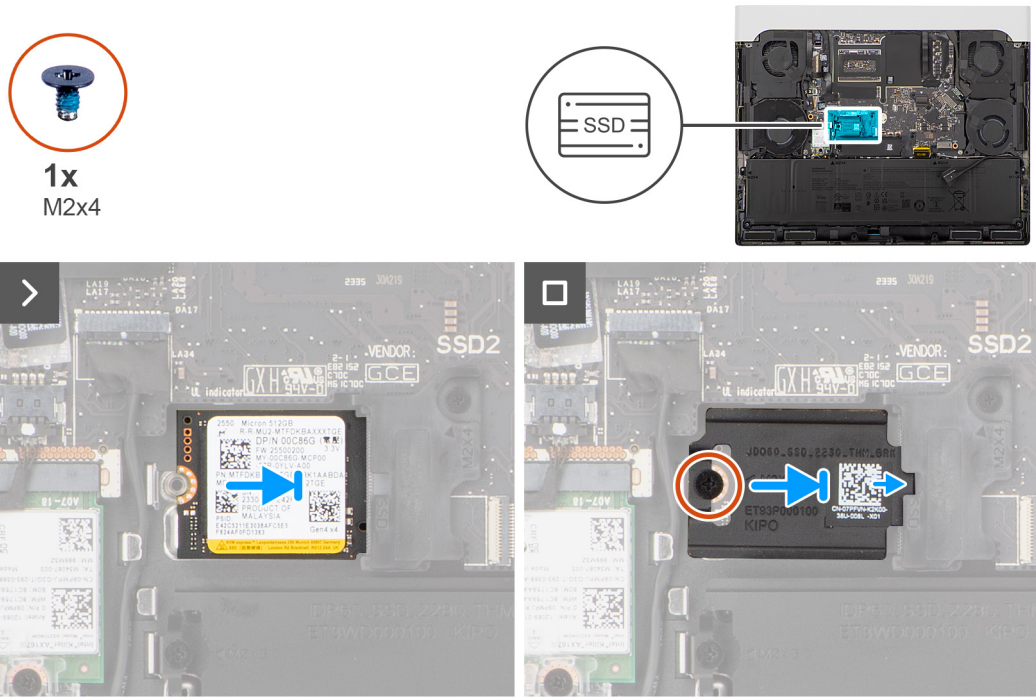

Figure 16. Installing the M.2 2230 SSD

Steps

1. Align the notch on the SSD with the tab on the SSD slot.
2. Slide the SSD into the SSD slot.
3. Slide the SSD thermal shield into the SSD slot.
4. Align the screw hole on the SSD thermal shield with the screw hole on the SSD and palm-rest and keyboard assembly.
5. Replace the screw (M2x4) that secures the M.2 2230 SSD thermal shield to the SSD and palm-rest and keyboard assembly.

NOTE: Repeat step 1 to step 5 to install the SSD on the SSD-1 slot on your computer.

Next steps

1. Install the [base cover](#).
2. Follow the procedure in [After working inside your computer](#).

Removing the M.2 2280 solid state drive (SSD)

Prerequisites

1. Follow the procedure in [Before working inside your computer](#).
2. Remove the [base cover](#).

About this task

NOTE: The following procedure applies only to computers shipped with an M.2 2280 SSD.

NOTE: Computers that are shipped with NVIDIA GeForce RTX 4060/4070 graphics card support one M.2 2230 and one M.2 2280 solid state drive slot, whereas computers shipped with NVIDIA GeForce RTX 4080/4090 graphics card support two M.2 2280 solid state drive slots.

The following images indicate the location of the M.2 2280 SSD in SSD-1 and provide a visual representation of the removal procedure.

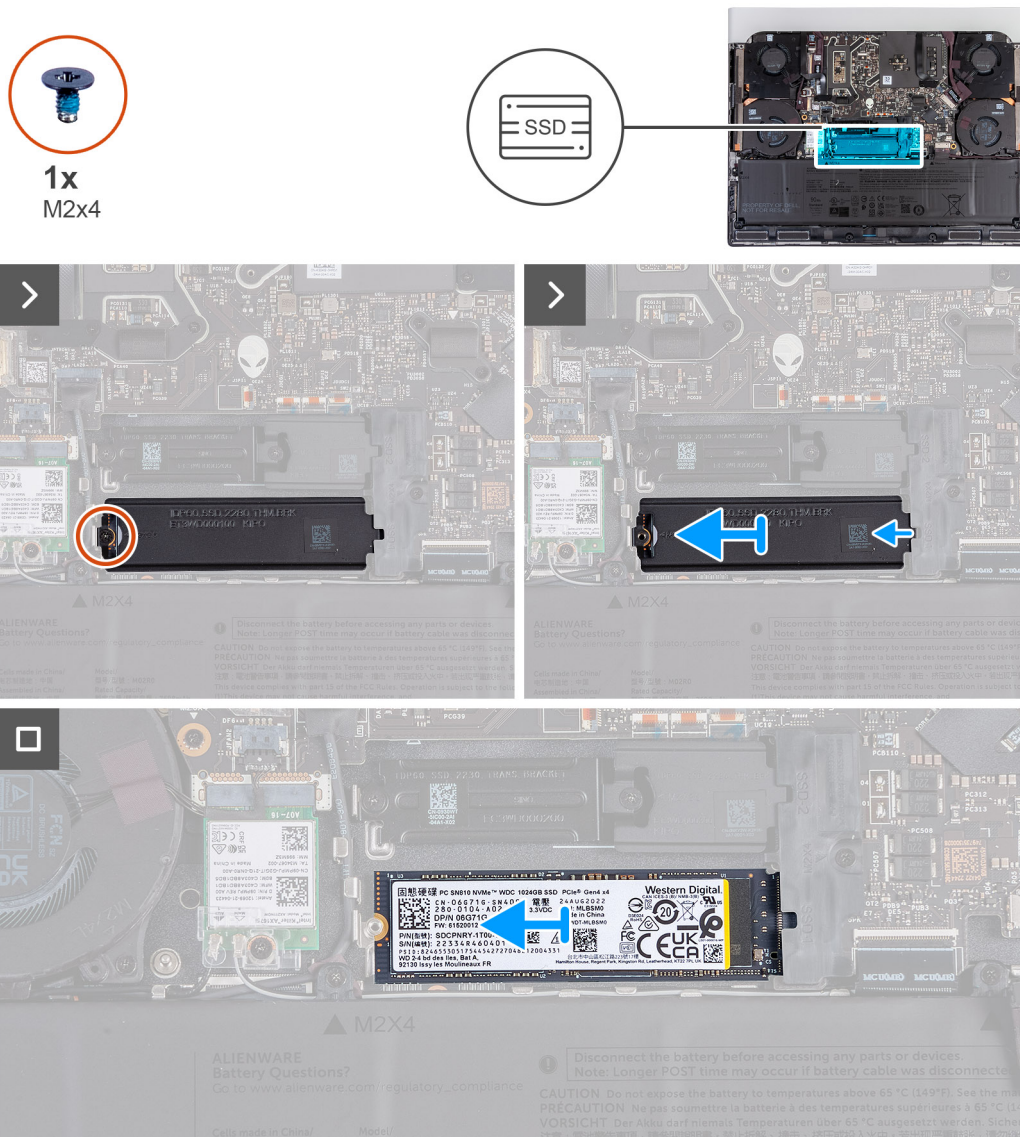

Figure 17. Removing M.2 2280 SSD in SSD-1

Steps

1. Remove the screw (M2x4) that secures the SSD thermal shield to the SSD and palm-rest and keyboard assembly.
2. Lift and remove the SSD thermal shield off the SSD.
3. Slide and remove the SSD from the SSD slot.

NOTE: Repeat step 1 to step 3 to remove the SSD on the SSD-2 slot on your computer.

Installing the M.2 2280 solid state drive (SSD)

Prerequisites

If you are replacing a component, remove the existing component before performing the installation process.

About this task

NOTE: The following procedure applies only to computers shipped with an M.2 2280 SSD.

NOTE: Computers that are shipped with NVIDIA GeForce RTX 4060/4070 graphics card support one M.2 2230 and one M.2 2280 solid state drive slot, whereas computers shipped with NVIDIA GeForce RTX 4080/4090 graphics card support two M.2 2280 solid state drive slots.

The following images indicate the location of the M.2 2280 SSD in SSD-1 and provide a visual representation of the installation procedure.

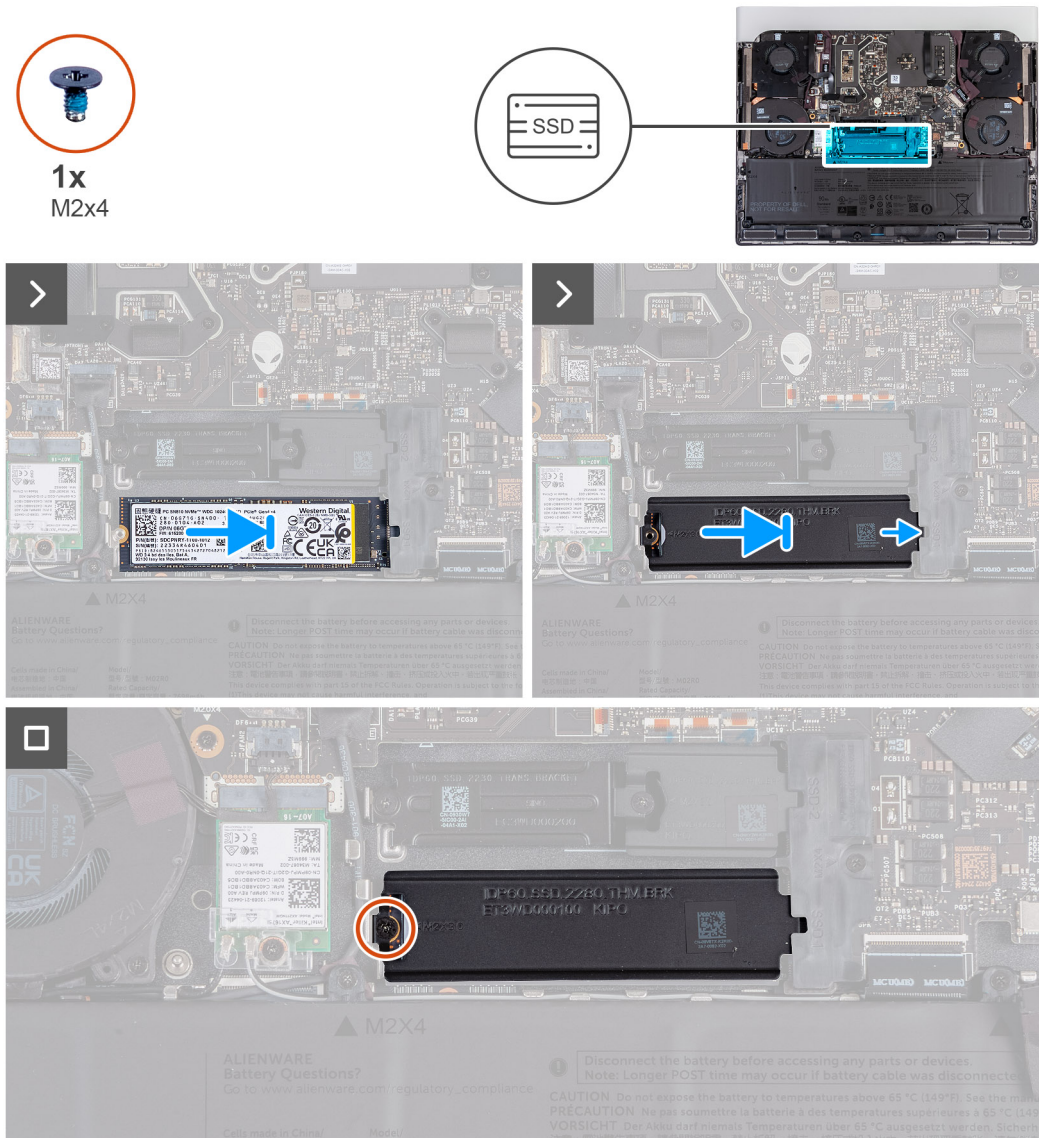

Figure 18. Installing M.2 2280 SSD

Steps

1. Align the notch on the SSD with the tab on the SSD slot.
2. Slide the SSD into the SSD slot.
3. Slide the SSD thermal shield into the SSD slot.
4. Align the screw hole on the SSD thermal shield with the screw hole on the SSD and palm-rest and keyboard assembly.
5. Replace the screw (M2x4) that secures the M.2 2280 SSD thermal shield to the SSD and palm-rest and keyboard assembly.

NOTE: Repeat step 1 to step 5 to install the SSD on the SSD-2 slot on your computer.

Next steps

1. Install the [base cover](#).

2. Follow the procedure in [After working inside your computer.](#)

Solid state drive bracket

Removing the solid state drive bracket

Prerequisites

1. Follow the procedure in [Before working inside your computer.](#)
2. Remove the [base cover.](#)
3. Remove the [M.2 2230 solid state drive](#) or [M.2 2280 solid state drive](#), as applicable.

About this task

The following images indicate the location of the solid state drive bracket and provide a visual representation of the removal procedure.

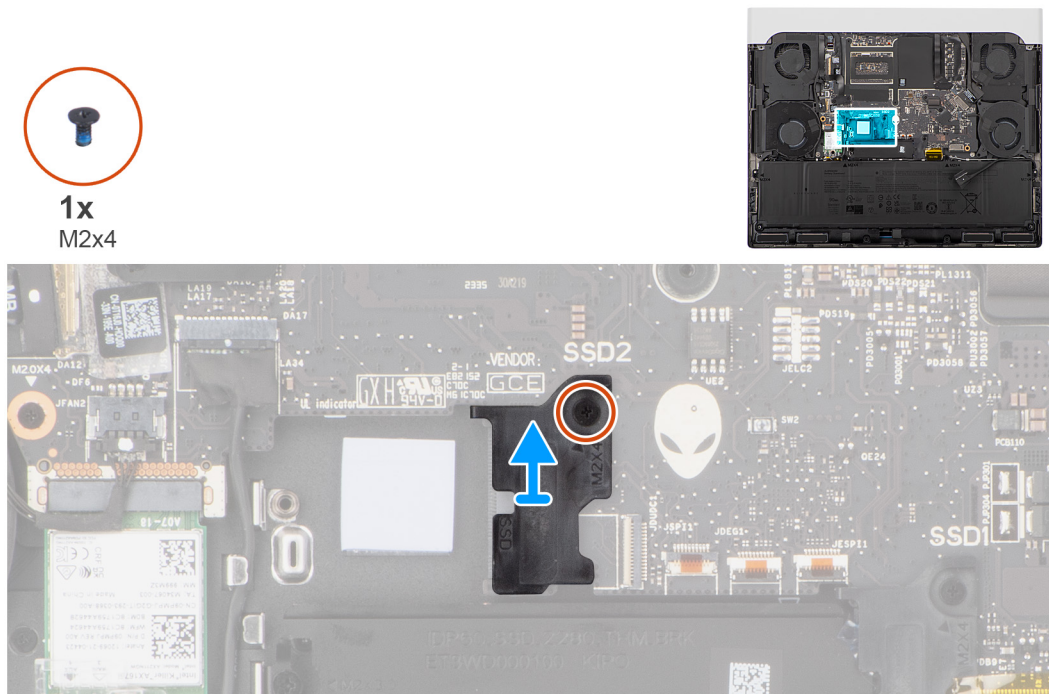

Figure 19. Removing the solid state drive bracket

Steps

1. Remove the screw (M2x4) that secures the solid state drive bracket to the palm-rest and keyboard assembly.
i **NOTE:** For computers shipped with an NVIDIA GeForce RTX 4060 or 4070 graphics card, remove the two screws (M2x4) that secures the solid state drive bracket to the palm-rest and keyboard assembly.

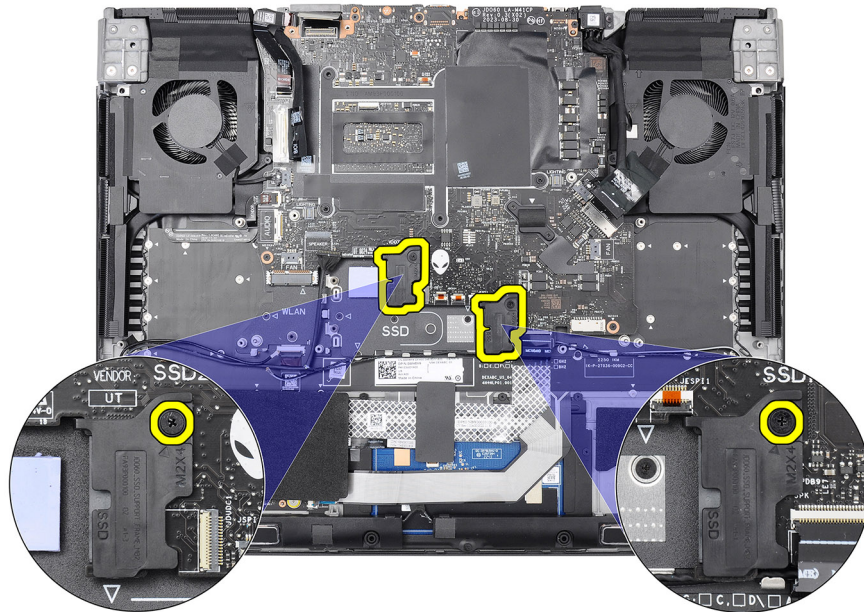

Figure 20. Solid state drive bracket

NOTE: For computers shipped with an NVIDIA GeForce RTX 4080 or 4090 graphics card, remove the single screw (M2x4) that secures the solid state drive bracket to the palm-rest and keyboard assembly.

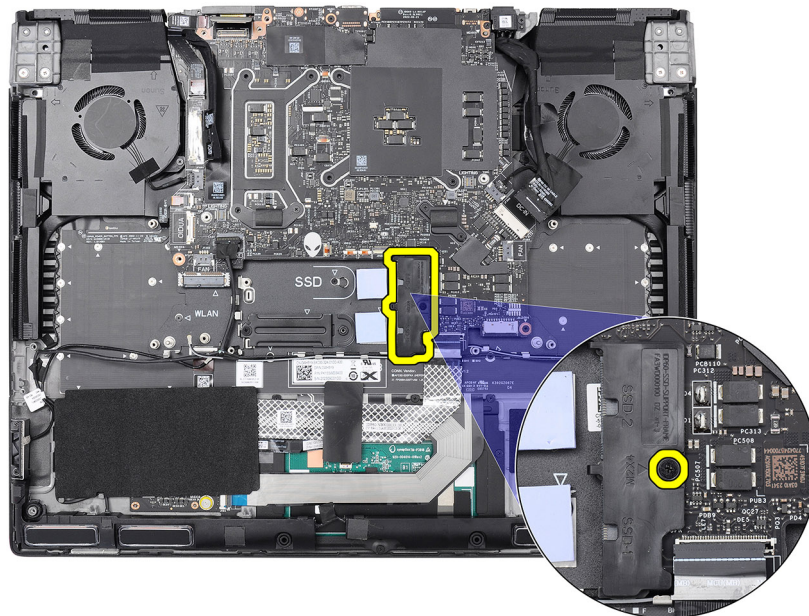

Figure 21. Solid state drive bracket

2. Lift the solid state drive bracket off the palm-rest and keyboard assembly.

Installing the solid state drive bracket

About this task

The following images indicate the location of the solid state drive bracket and provide a visual representation of the installation procedure.



1x
M2x4

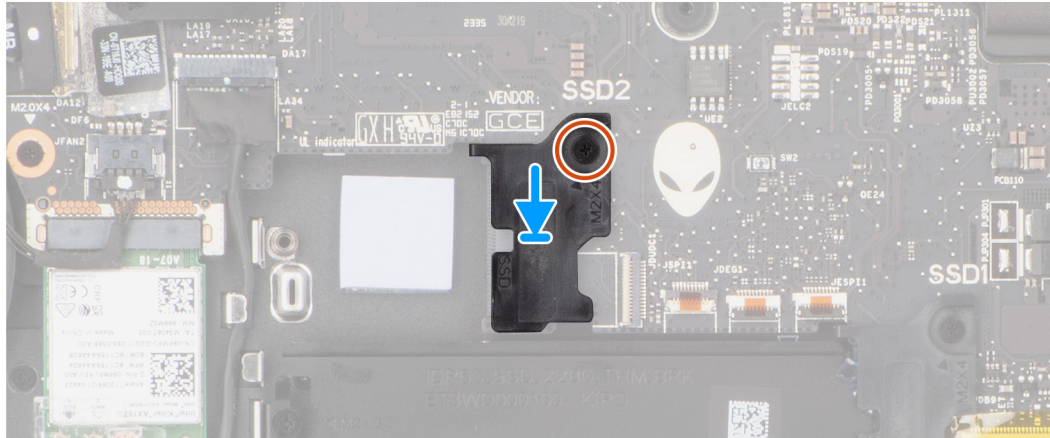
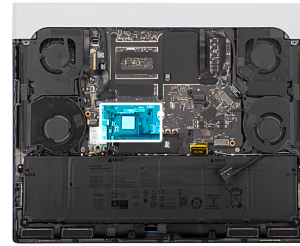

Figure 22. Installing the solid state drive bracket

Steps

1. Align the screw hole on the solid state drive bracket with the screw hole on the palm-rest and keyboard assembly.
 2. Replace the screw (M2x4) that secures the solid state drive bracket to the palm-rest and keyboard assembly.
- (i) NOTE:** For computers shipped with an NVIDIA GeForce RTX 4060 or 4070 graphics card, replace the two screws (M2x4) that secures the solid state drive bracket to the palm-rest and keyboard assembly.

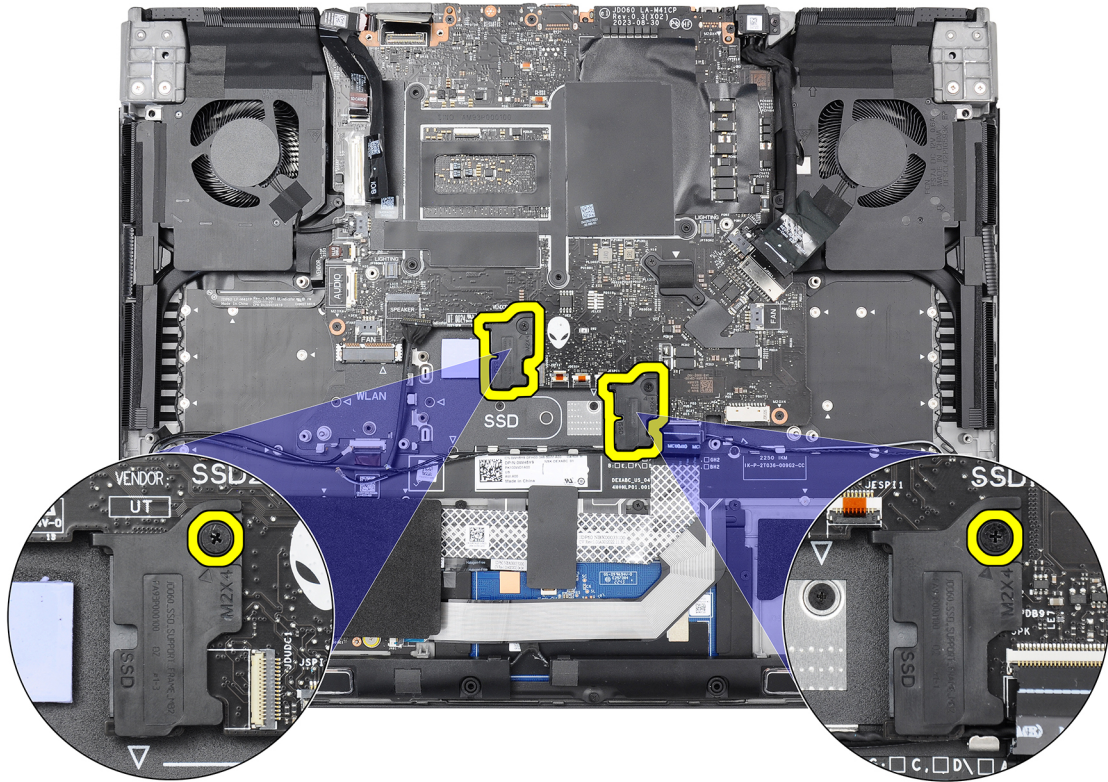

Figure 23. Solid state drive bracket

- i** **NOTE:** For computers shipped with an NVIDIA GeForce RTX 4080 or 4090 graphics card, replace the single screw (M2x4) that secures the solid state drive bracket to the palm-rest and keyboard assembly.

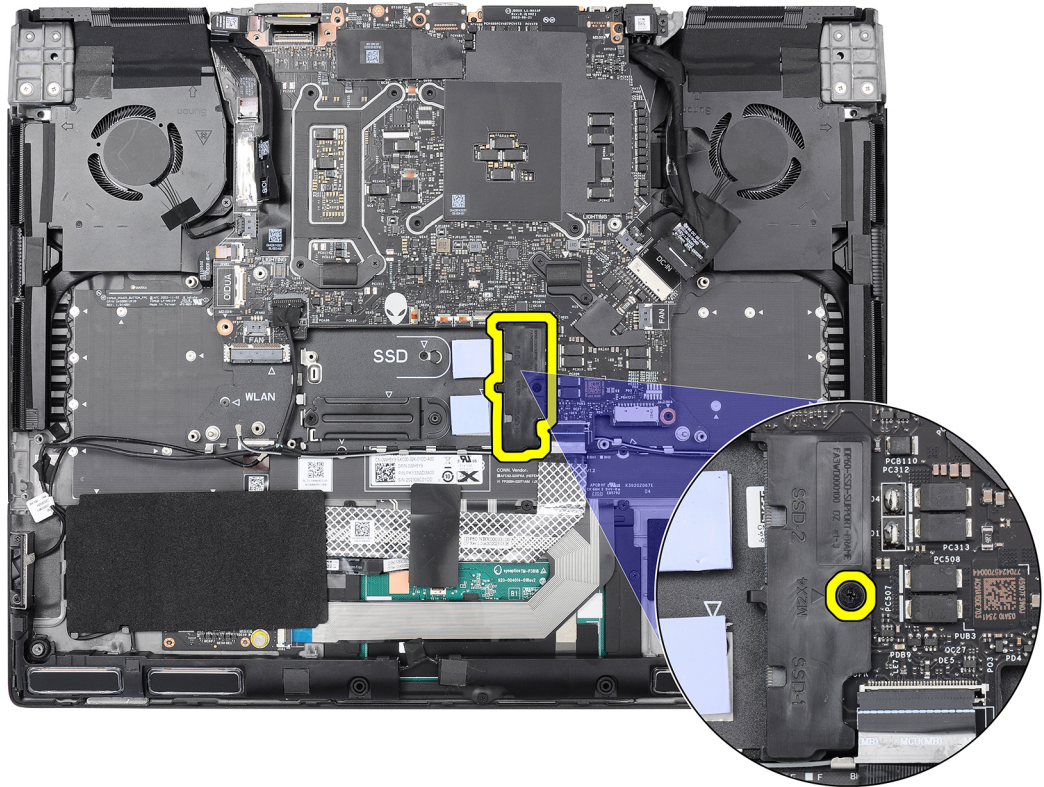

Figure 24. Solid state drive bracket

Next steps

1. Install the [M.2 2230 solid state drive](#) or [M.2 2280 solid state drive](#), as applicable.
2. Install the [base cover](#).
3. Follow the procedure in [After working inside your computer](#).

Wireless card

Removing the wireless card

Prerequisites

1. Follow the procedure in [Before working inside your computer](#).
2. Remove the [base cover](#).

About this task

The following images indicate the location of the wireless card and provide a visual representation of the removal procedure.



2x
M2x4

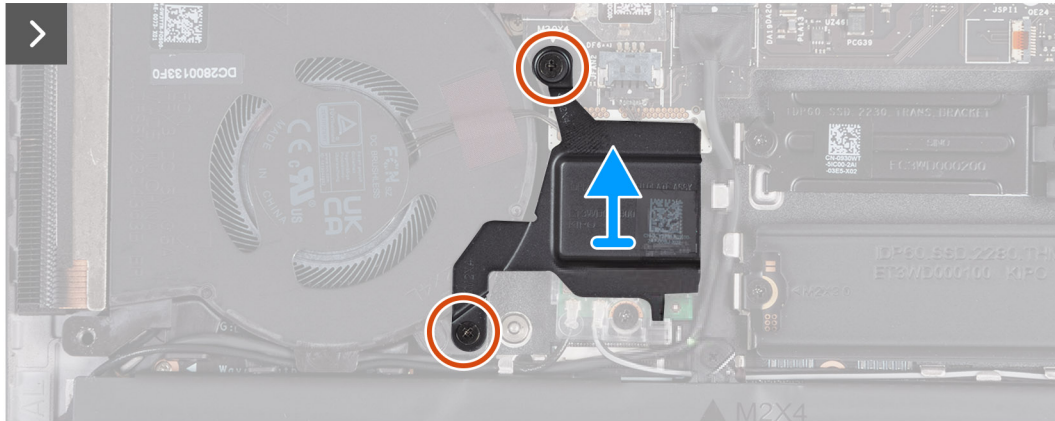

Figure 25. Removing the wireless card thermal shield

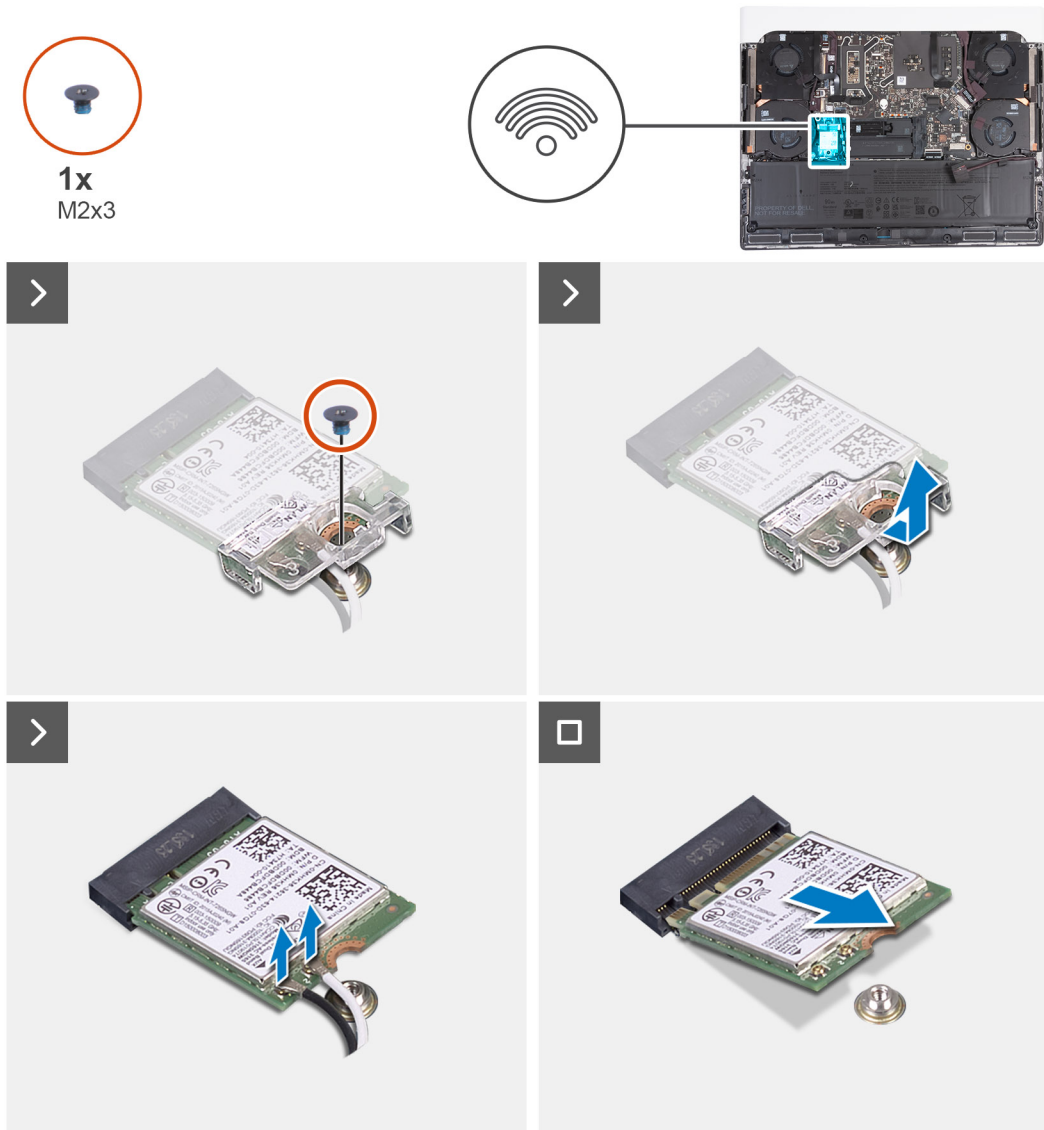

Figure 26. Removing the wireless card

Steps

1. Remove the two screws (M2x4) that secures the wireless card thermal shield to the wireless card and palm-rest and keyboard assembly.
 - ⓘ **NOTE:** The thermal shield is applicable for computers that are shipped with certain configurations only.
2. Lift the wireless card thermal shield off the palm-rest and keyboard assembly.
3. Remove the screw (M2x3) that secures the wireless-card bracket to the wireless card and palm-rest and keyboard assembly.
4. Slide and remove the wireless-card bracket off the wireless card.
5. Disconnect the antenna cables from the wireless card.
6. Slide and remove the wireless card from the wireless-card slot.

Installing the wireless card

Prerequisites

If you are replacing a component, remove the existing component before performing the installation process.

About this task

The following images indicate the location of the wireless card and provide a visual representation of the installation procedure.

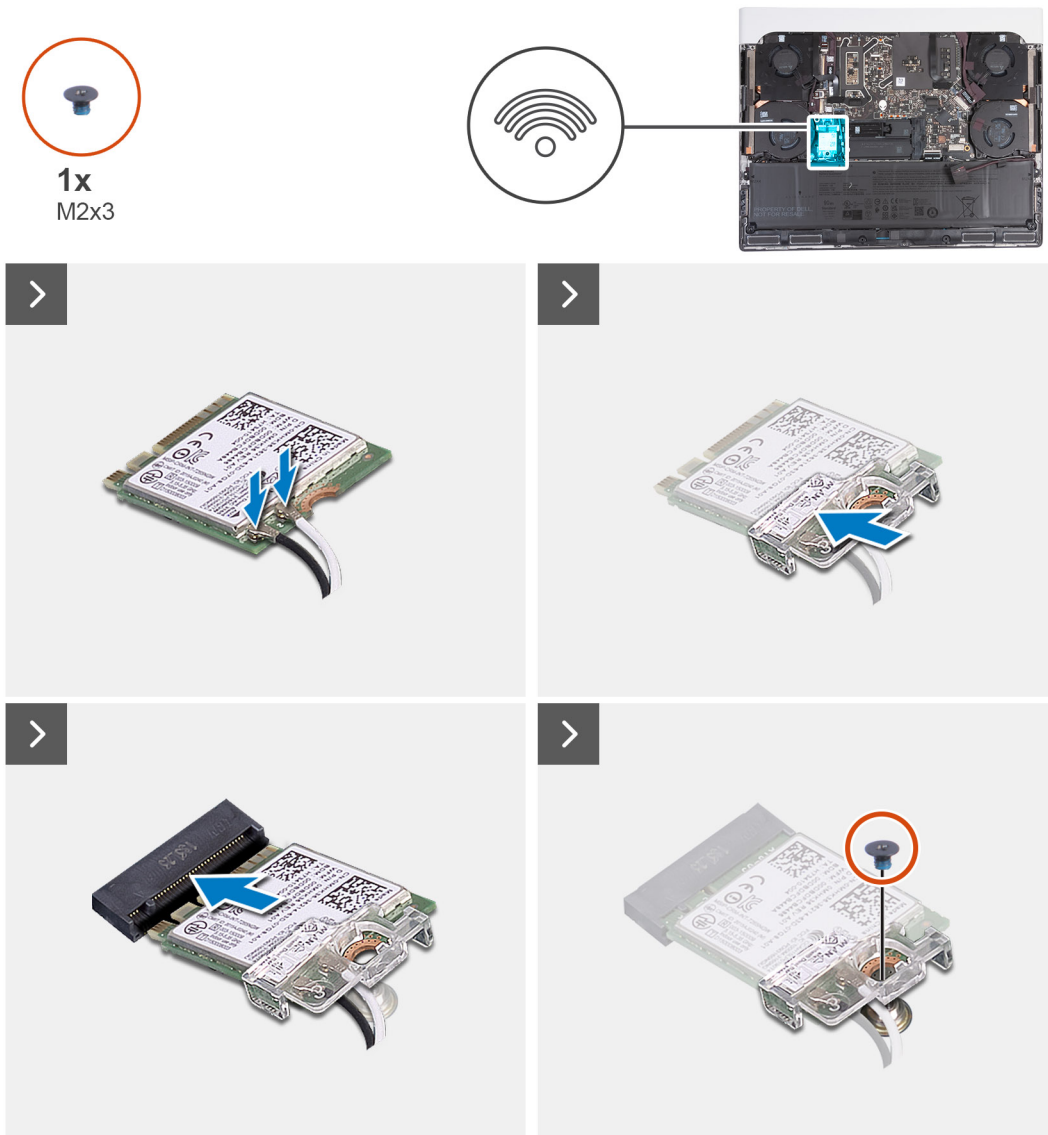

Figure 27. Installing the wireless card



2x
M2x4

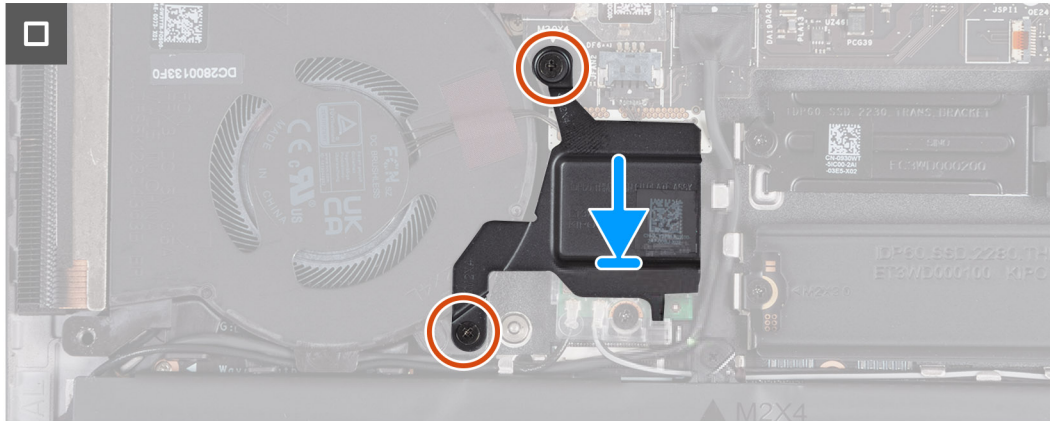

Figure 28. Installing the wireless card thermal shield

Steps

1. Connect the antenna cables to the wireless card.

The following table provides the antenna-cable color scheme for the wireless card that is supported by your computer.

Table 25. Antenna-cable color scheme

Connectors on the wireless card	Antenna-cable color	Silkscreen marking	
Main	White	MAIN	△ (white triangle)
Auxiliary	Black	AUX	▲ (black triangle)

2. Align the notch on the wireless card with the tab on the wireless-card slot and insert the wireless card at an angle into the wireless-card slot.
3. Align the screw hole on the wireless-card bracket with the screw hole on the wireless card and palm-rest and keyboard assembly.
4. Replace the screw (M2x3) that secures the wireless-card bracket to the wireless card and the palm-rest and keyboard assembly.
5. Align the screw hole on the wireless card thermal shield with the screw hole on the palm-rest and keyboard assembly.
6. Replace the two screws (M2x4) that secures the wireless card thermal shield to the wireless card and palm-rest and keyboard assembly.

NOTE: The thermal shield is applicable for computers that are shipped with certain configurations only.

Next steps

1. Install the [base cover](#).
2. Follow the procedure in [After working inside your computer](#).

Rear I/O-cover

Removing the rear I/O-cover

Prerequisites

1. Follow the procedure in [Before working inside your computer.](#)
2. Remove the [base cover.](#)

About this task

The following images indicate the location of the rear I/O-cover and provide a visual representation of the removal procedure.

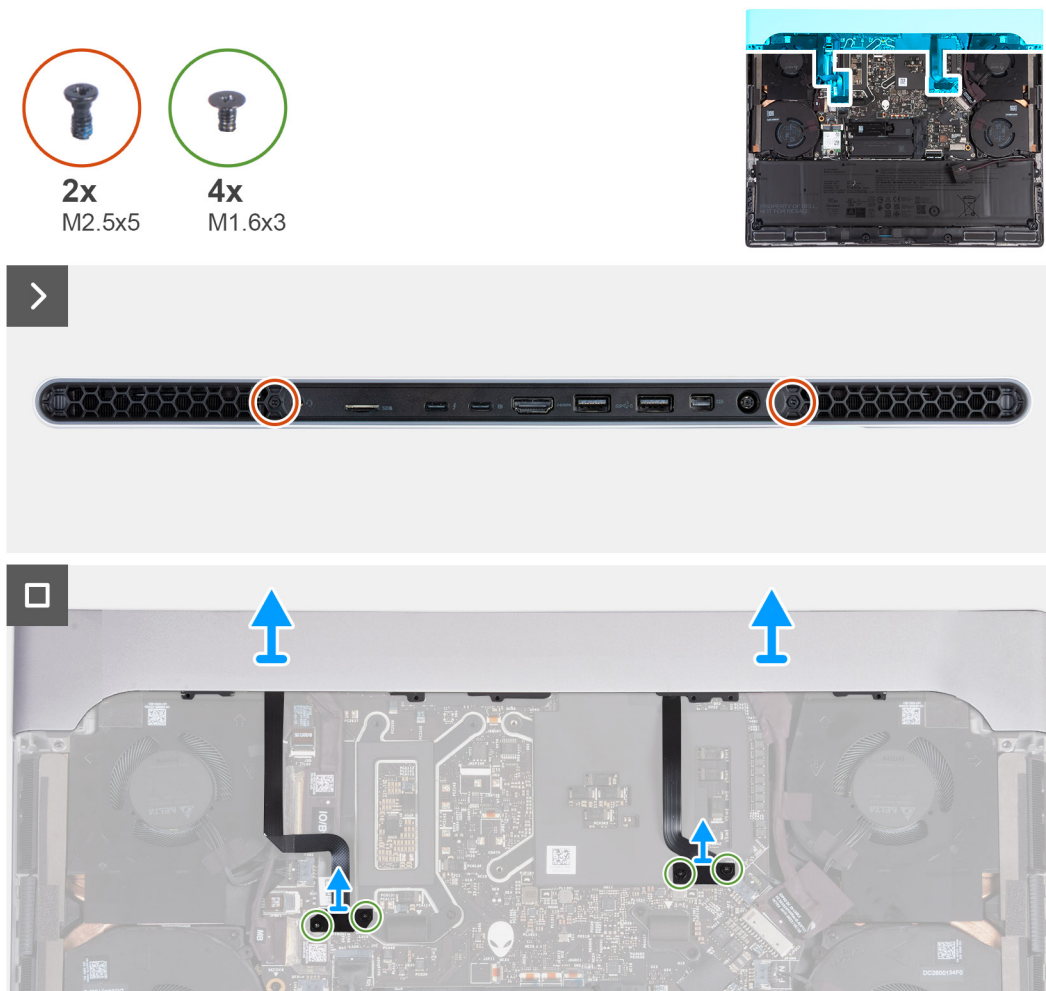

Figure 29. Removing the rear I/O cover

Steps

1. Remove the two screws (M2.5x5) that secure the rear I/O-cover to the palm-rest and keyboard assembly.
2. Remove the four screws (M1.6x3) that secure the left and right Tron-light cables to the palm-rest and keyboard assembly.
CAUTION: Do not pull at the bend points of the Tron-light cables and check for damage while removing and installing the rear I/O cover.
3. Disconnect the left and right Tron-light cables from the connectors on the system board.

NOTE: To prevent damaging your computer, ensure that the Tron-light cable has been disconnected from the system board before removing the rear I/O-cover. To see the location of the Tron-light cable, see system board components in [Removing the system board](#).

4. Firmly grasp the sides of your computer with both hands and push it outwards to remove the rear I/O-cover off the palm-rest and keyboard assembly.

Installing the rear I/O-cover

Prerequisites

If you are replacing a component, remove the existing component before performing the installation process.

About this task

The following images indicate the location of the rear I/O-cover and provide a visual representation of the installation procedure.

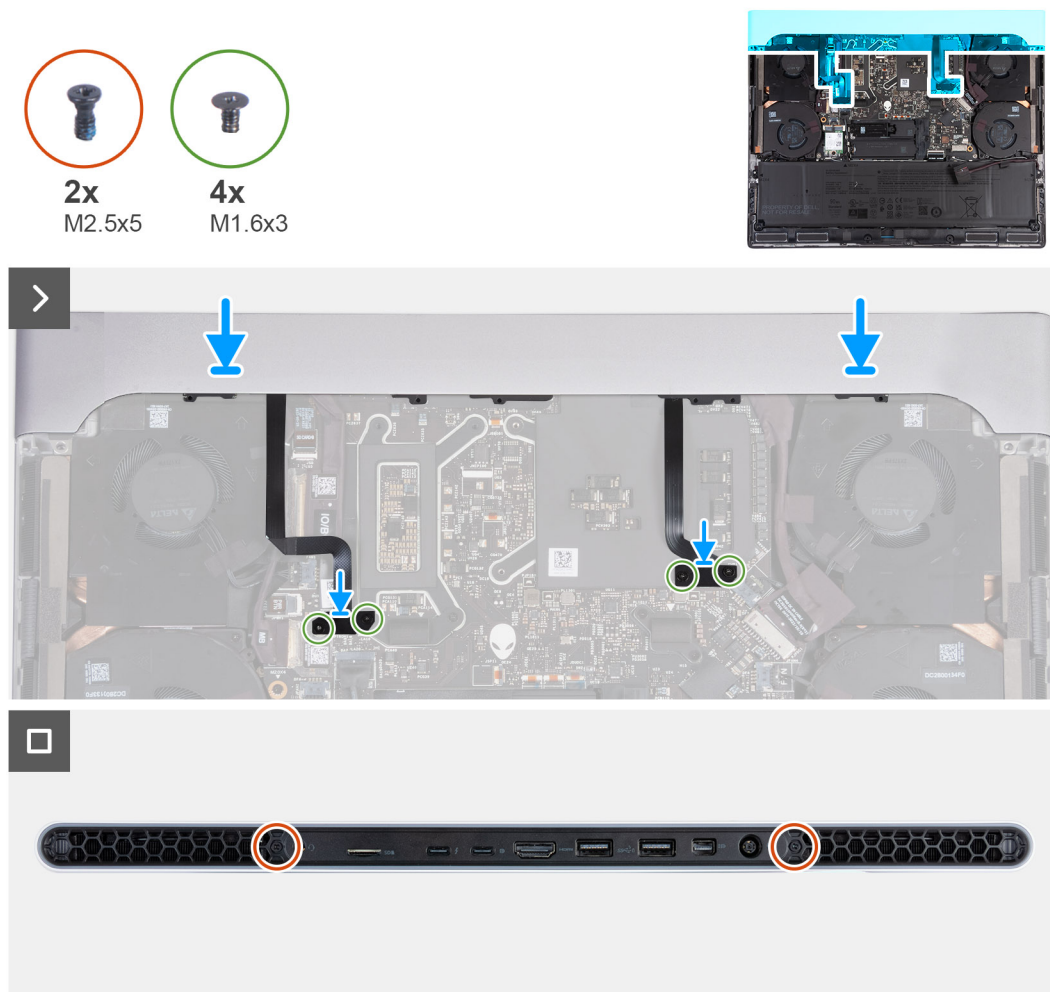

Figure 30. Installing the rear I/O cover

NOTE: To avoid damaging your computer, ensure that the Tron-light cable is not pinched when sliding the rear I/O-cover into the palm-rest and keyboard assembly.

Steps

1. With the correct orientation, slide the rear I/O-cover into the palm-rest and keyboard assembly, and snap it into place.
2. Connect the left and right Tron-light cable to the connectors on the system board.

3. Replace the four screws (M1.6x3) that secure the left and right Tron-light cables to the palm-rest and keyboard assembly.

 **CAUTION: Do not pull at the bend points of the Tron-light cables and check for damage while removing and installing the rear I/O cover.**

4. Replace the two screws (M2.5x5) that secure the rear I/O-cover to the palm-rest and keyboard assembly.

Next steps

1. Install the [base cover](#).
2. Follow the procedure in [After working inside your computer](#).

Removing and installing Field Replaceable Units (FRUs)

The replaceable components in this chapter are Field Replaceable Units (FRUs).

- △ **CAUTION:** The information in this section is intended for authorized service technicians only.
- △ **CAUTION:** To avoid any potential damage to the component or loss of data, ensure that an authorized service technician replaces the Field Replaceable Units (FRUs).
- △ **CAUTION:** Dell Technologies recommends that this set of repairs, if needed, to be conducted by trained technical repair specialists.
- △ **CAUTION:** As a reminder, your warranty does not cover damages that may occur during FRU repairs that are not authorized by Dell Technologies.
- ① **NOTE:** The images in this document may differ from your computer depending on the configuration you ordered.

Battery

Rechargeable Li-ion battery precautions

- △ **CAUTION:**
 - Exercise caution when handling rechargeable Li-ion batteries.
 - Discharge the battery completely before removing it. Disconnect the AC power adapter from the computer and operate the computer solely on battery power—the battery is fully discharged when the computer no longer turns on when the power button is pressed.
 - Do not crush, drop, mutilate, or penetrate the battery with foreign objects.
 - Do not expose the battery to high temperatures, or disassemble battery packs and cells.
 - Do not apply pressure to the surface of the battery.
 - Do not bend the battery.
 - Do not use tools of any kind to pry on or against the battery.
 - To prevent accidental puncture or damage to the battery and other components, ensure that no screws are lost or misplaced during the servicing of this product.
 - If the battery gets stuck inside your computer as a result of swelling, do not try to release it as puncturing, bending, or crushing a rechargeable Li-ion battery can be dangerous. In such an instance, contact Dell technical support for assistance. See [Contact Support at Dell Support Site](#).
 - Always purchase genuine batteries from [Dell Site](#) or authorized Dell partners and resellers.
 - Swollen batteries should not be used and should be replaced and disposed properly. For guidelines on how to handle and replace swollen rechargeable Li-ion batteries, see [Handling swollen rechargeable Li-ion batteries](#).

Removing the battery

- △ **CAUTION:** This computer is designed without a coin-cell battery. After a service incident where the computer battery is disconnected, when the battery is fully discharged, or when the computer is reassembled and turned on, an RTC reset cycle will occur. When an RTC reset cycle occurs, the computer turns on and off three times. An Invalid Configuration error message is displayed prompting you to enter the BIOS and configure the date and time. The computer starts functioning after setting the date and time.
- △ **CAUTION:** The information in this removal section is intended for authorized service technicians only.

Prerequisites

1. Follow the procedure in [Before working inside your computer.](#)
2. Remove the [base cover.](#)

About this task

⚠ **CAUTION: Removing the battery resets the BIOS setup settings to default. It is recommended that you note the BIOS setup settings before removing the battery.**

The following images indicate the location of the battery and provide a visual representation of the removal procedure.

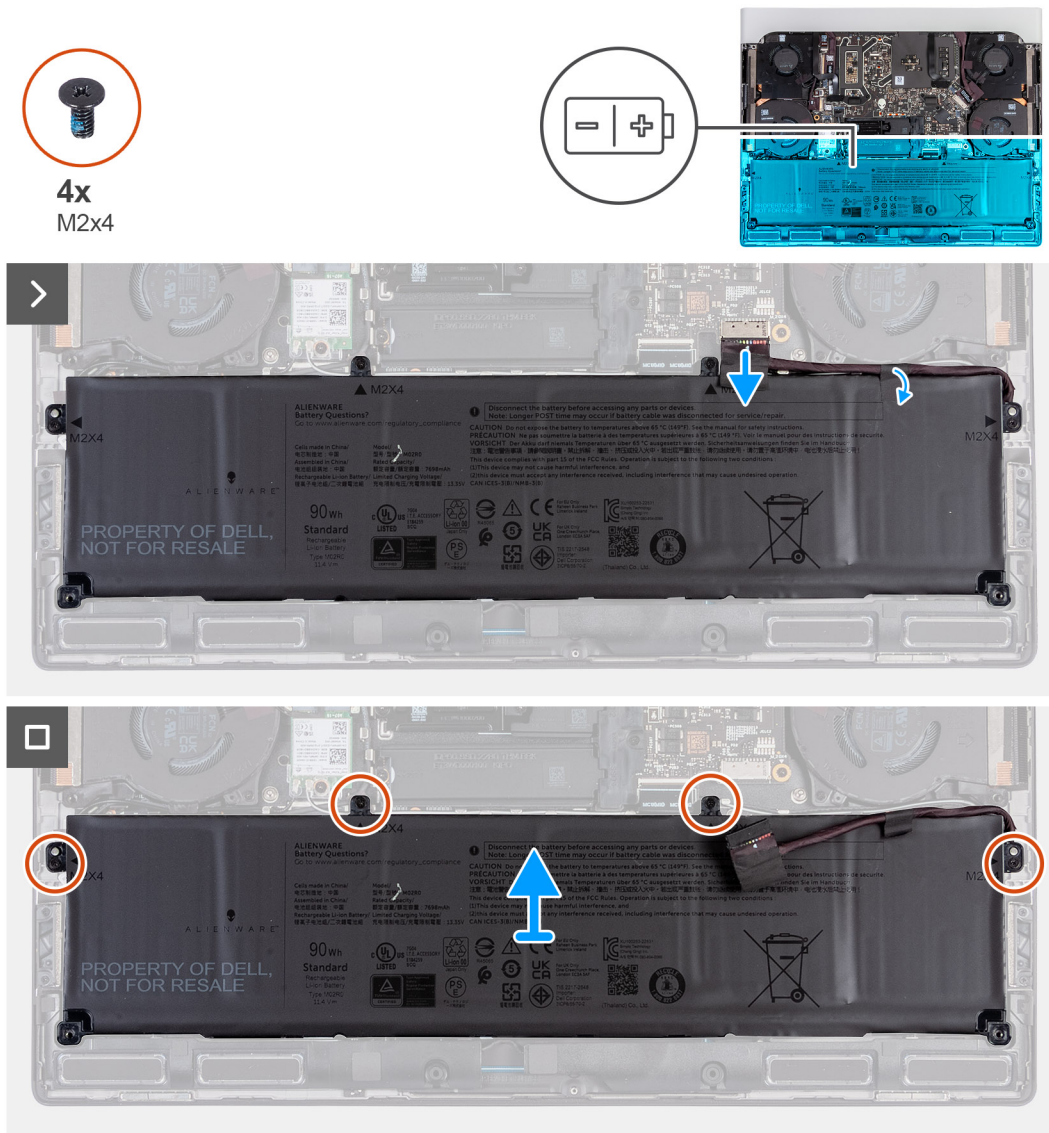

Figure 31. Removing the battery

Steps

1. Disconnect the battery cable from the system board (if not disconnected earlier).
2. Peel the tape that secures the battery cable to the battery.
3. Remove the four screws (M2x4) that secure the battery to the palm-rest and keyboard assembly.
4. Lift the battery off the palm-rest and keyboard assembly.

Installing the battery

CAUTION: The information in this installation section is intended for authorized service technicians only.

Prerequisites

If you are replacing a component, remove the existing component before performing the installation process.

About this task

The following images indicate the location of the battery and provide a visual representation of the installation procedure.

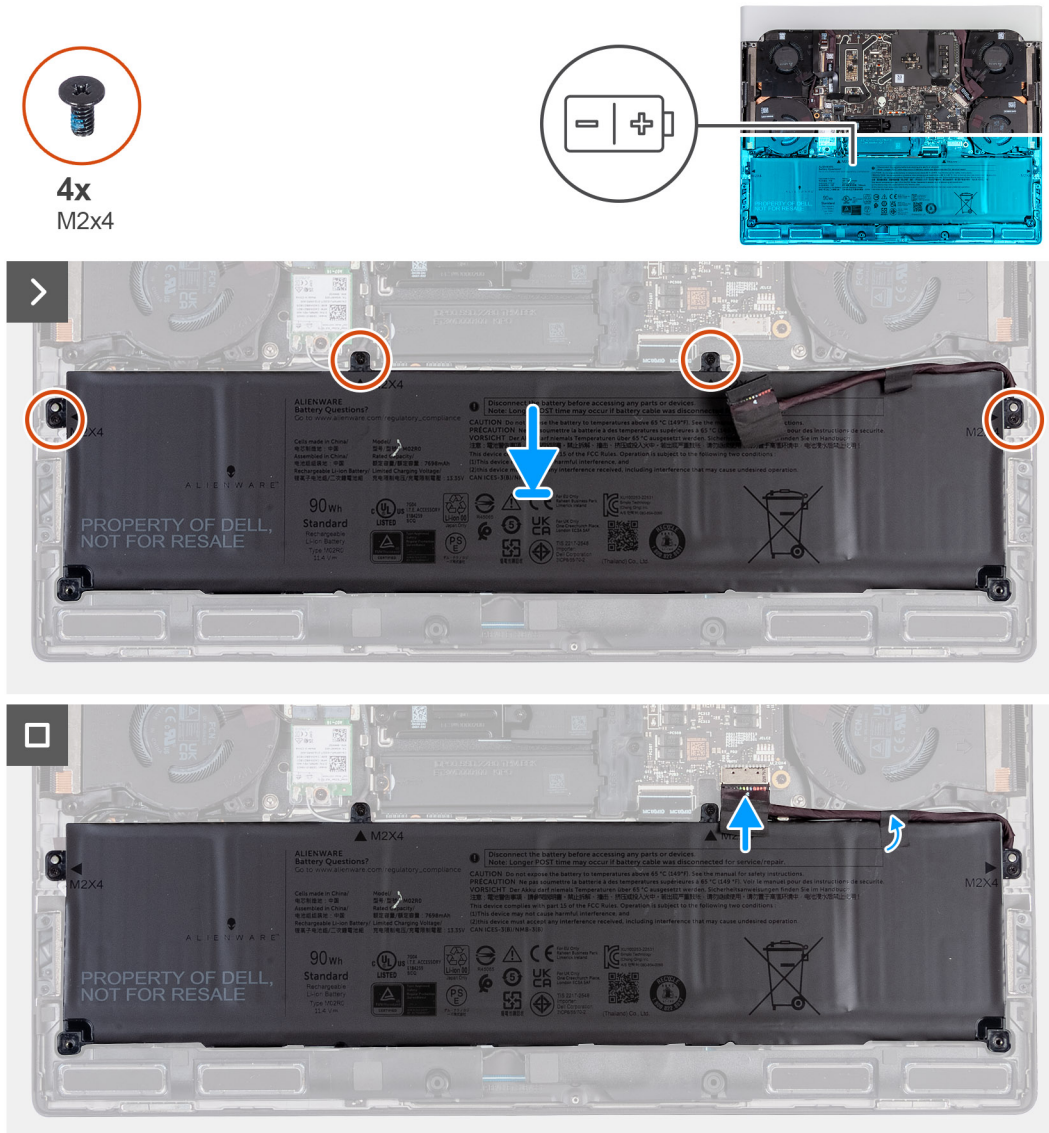

Figure 32. Installing the battery

Steps

1. Using the alignment posts, place the battery on the palm-rest and keyboard assembly.
2. Align the screw holes on the battery with the screw holes on the palm-rest and keyboard assembly.
3. Replace the four screws (M2x4) that secure the battery to the palm-rest and keyboard assembly.
4. Adhere the tape that secures the battery cable to the battery.
5. Connect the battery cable to the system board.

Next steps

1. Install the [base cover](#).
2. Follow the procedure in [After working inside your computer](#).

Battery cable

Removing the battery cable

 **CAUTION:** The information in this removal section is intended for authorized service technicians only.

Prerequisites

1. Follow the procedure in [Before working inside your computer](#).
2. Remove the [base cover](#).
3. Remove the [battery](#).

 **NOTE:** If the battery is disconnected from the system board for service, then there is a delay during boot as the computer undergoes RTC battery reset.

About this task

The following images indicate the location of the battery cable and provide a visual representation of the removal procedure.

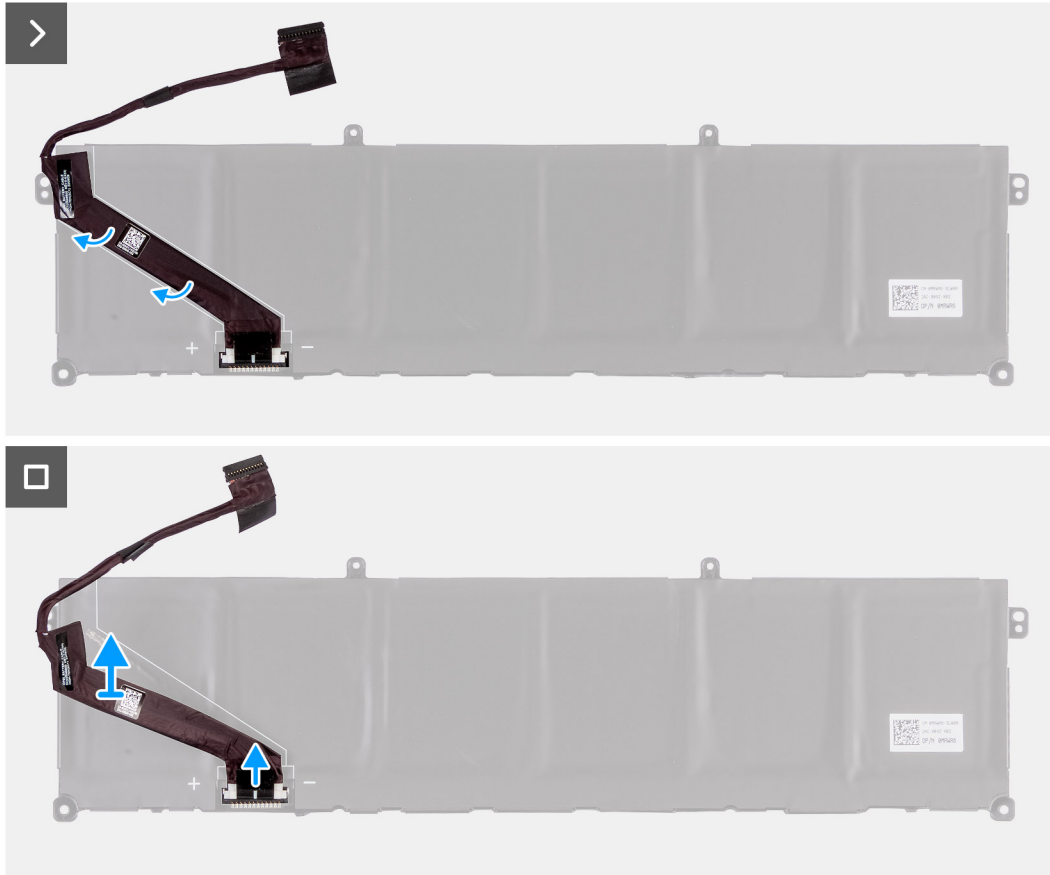

Figure 33. Removing the battery cable

Steps

1. Turn the battery over and peel the battery cable from the battery.
2. Disconnect the battery cable from the connector on the battery.
3. Lift the battery cable off the battery.

Installing the battery cable

⚠ CAUTION: The information in this installation section is intended for authorized service technicians only.

Prerequisites

If you are replacing a component, remove the existing component before performing the installation procedure.

About this task

The following images indicate the location of the battery cable and provide a visual representation of the installation procedure.

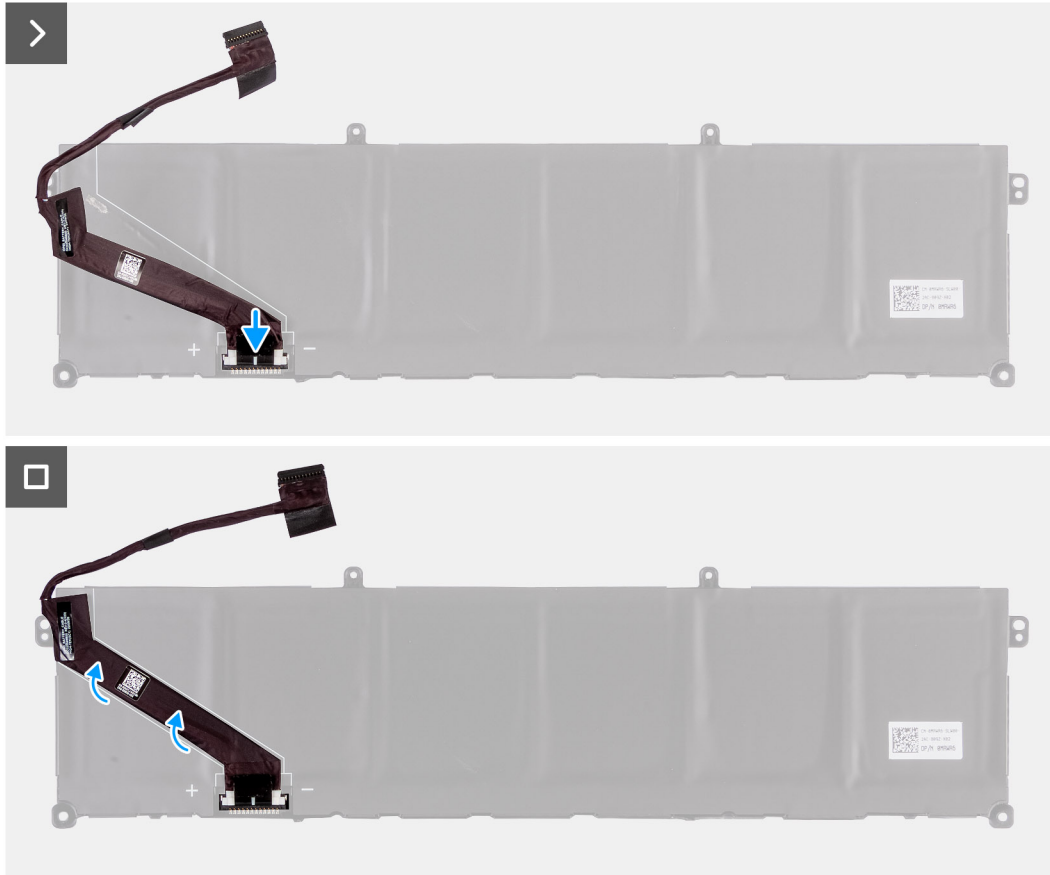

Figure 34. Installing the battery cable

Steps

1. Align and adhere the battery cable to the battery.
2. Connect the battery cable to the connector on the battery.

Next steps

1. Install the [battery](#).
2. Install the [base cover](#).
3. Follow the procedure in [After working inside your computer](#).

Touchpad

Removing the touchpad

Prerequisites

⚠ **CAUTION:** The information in this removal section is intended for authorized service technicians only.

1. Follow the procedure in [Before working inside your computer.](#)
2. Remove the [base cover.](#)
3. Remove the [battery.](#)

About this task

The following images indicate the location of the touchpad and provide a visual representation of the removal procedure.

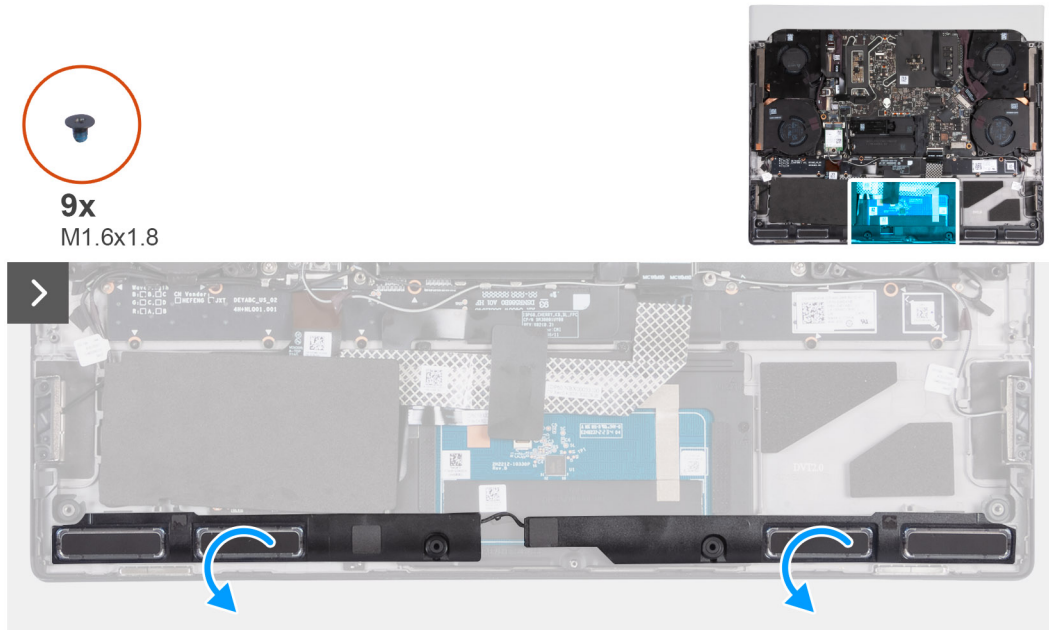

Figure 35. Removing the touchpad

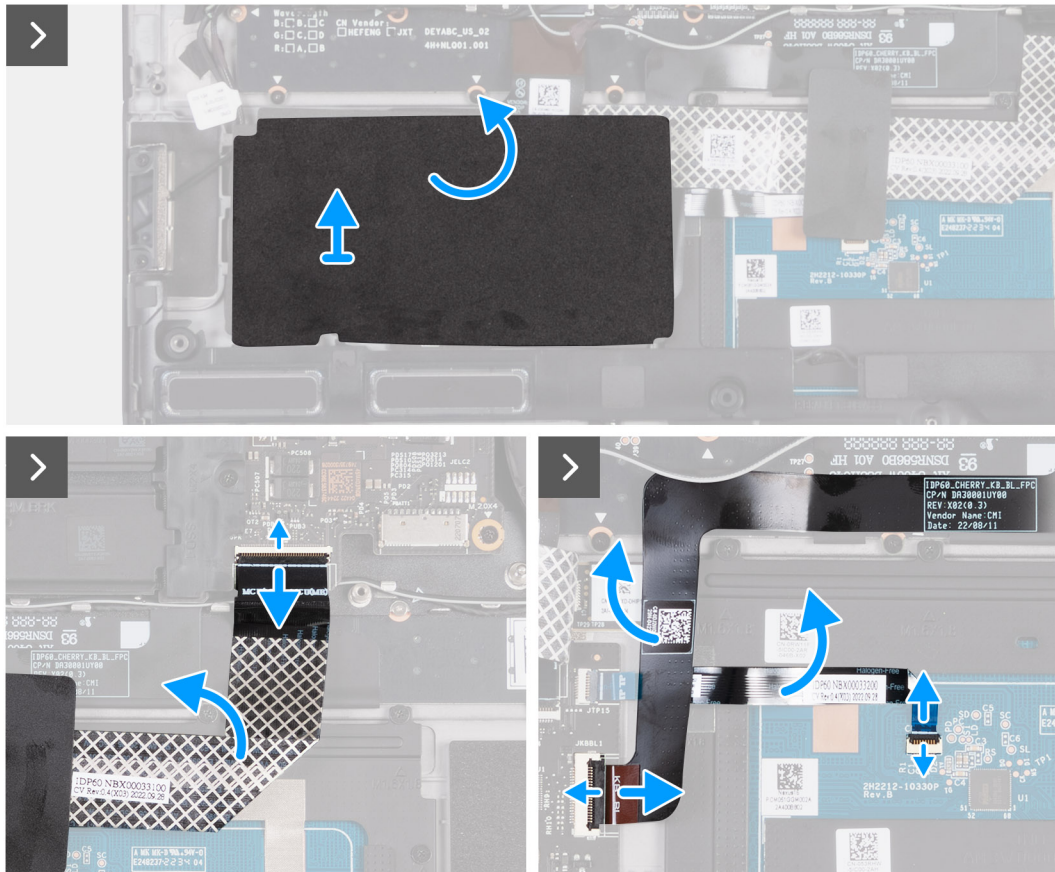

Figure 36. Removing the touchpad

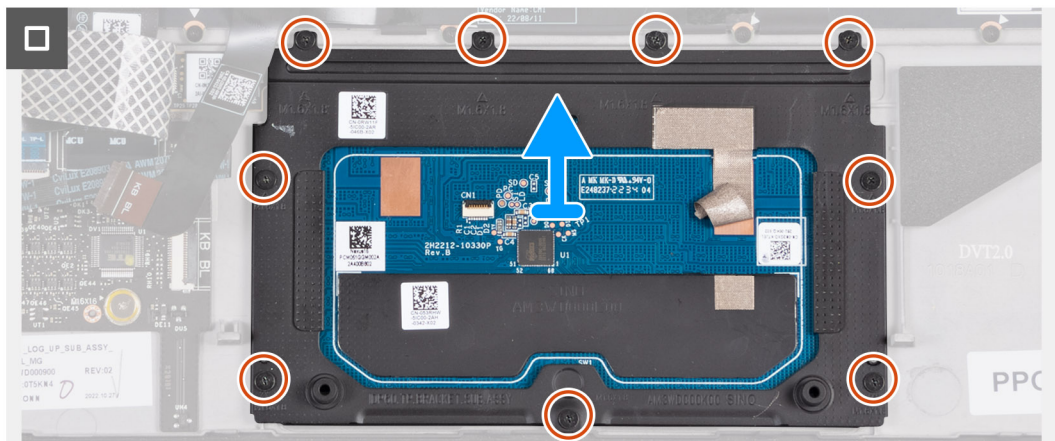

Figure 37. Removing the touchpad

Steps

1. Lift and place the two speakers off the palm-rest and keyboard assembly to access the touchpad.
 - ⓘ **NOTE:** Do not remove the speaker cables from the routing guides on the palm-rest and keyboard assembly.
2. Peel the Mylar and lift the Mylar off the keyboard-controller board.
3. Open the latch and disconnect the keyboard-controller board cable from the keyboard-controller board.
4. Fold up the keyboard-controller board cable.
5. Open the latch and disconnect the keyboard cable from the keyboard-controller board.
6. Fold up the keyboard cable.
7. Open the latch and disconnect the touchpad cable from the touchpad.

8. Fold up the touchpad cable.
9. Open the latch and disconnect the touchpad-light cable from the touchpad.
 - ⓘ **NOTE:** Your computer may be shipped with a touchpad-light cable depending on the configuration you have ordered.
10. Peel the tape that secures the touchpad to the palm-rest and keyboard assembly.
11. Remove the nine screws (M1.6x1.8) that secure the touchpad to the palm-rest and keyboard assembly.
12. Lift the touchpad off the palm-rest and keyboard assembly.

Installing the touchpad

⚠ **CAUTION:** The information in this installation section is intended for authorized service technicians only.

Prerequisites

If you are replacing a component, remove the existing component before performing the installation process.

About this task

The following images indicate the location of the touchpad and provide a visual representation of the installation procedure.

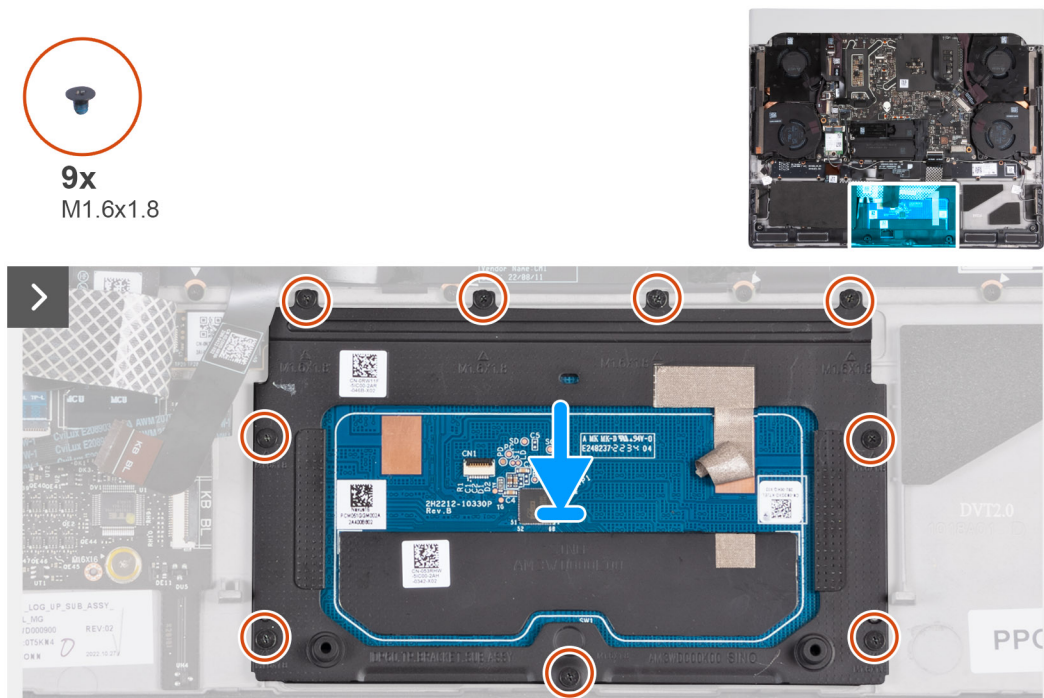

Figure 38. Installing the touchpad

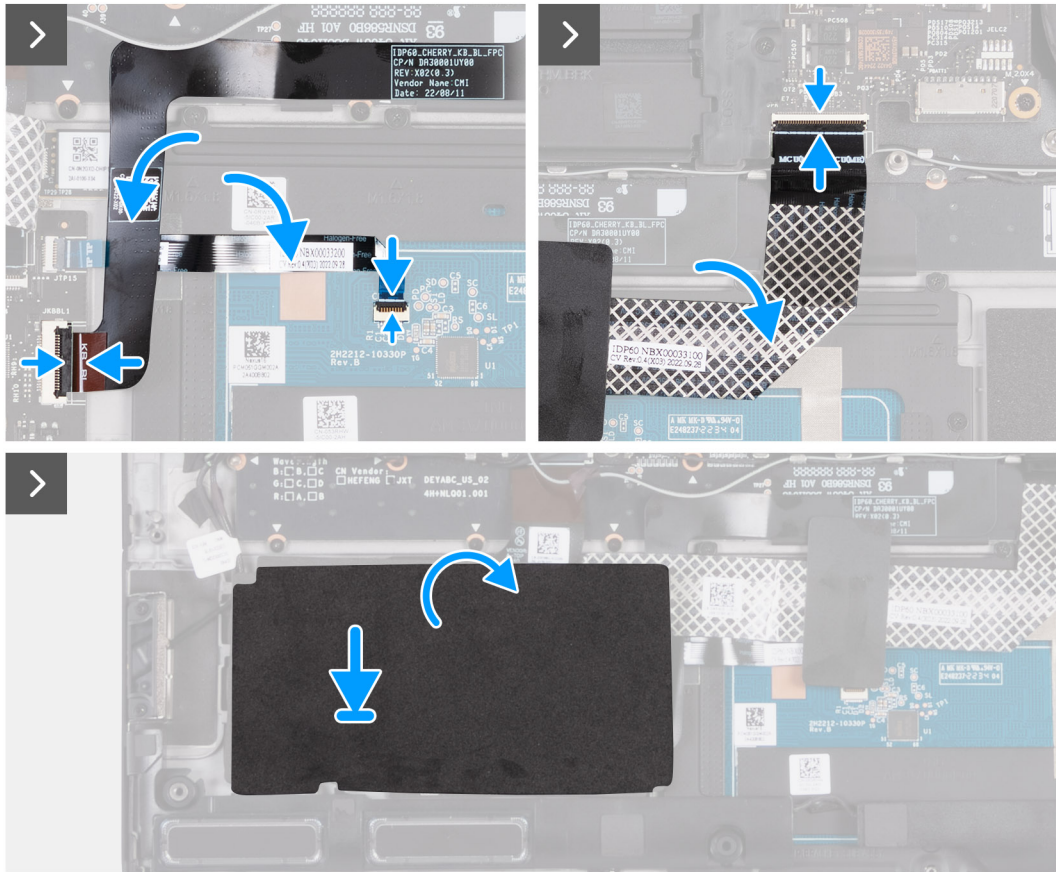

Figure 39. Installing the touchpad

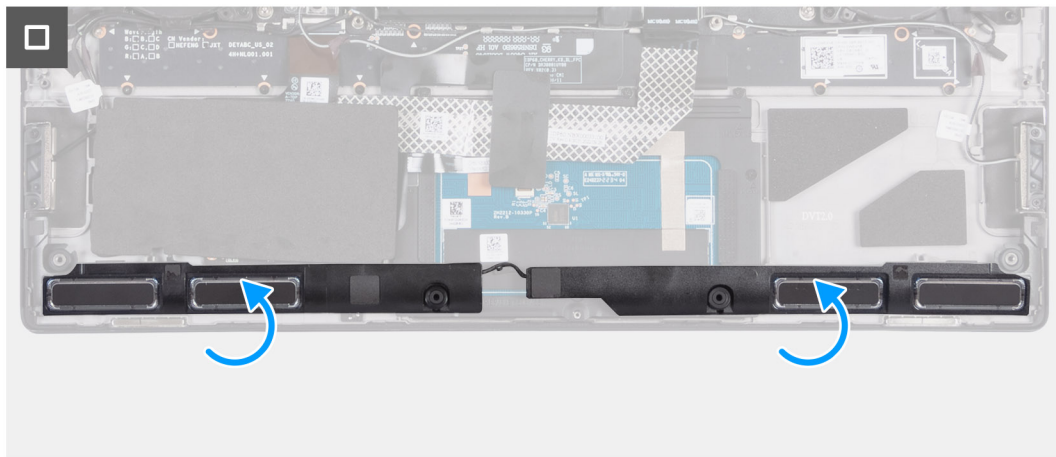

Figure 40. Installing the touchpad

Steps

1. Align and place the touchpad into the slot on the palm-rest and keyboard assembly.

(i) NOTE: Turn the computer over and open the display. Ensure that the touchpad is equally aligned along all four sides.

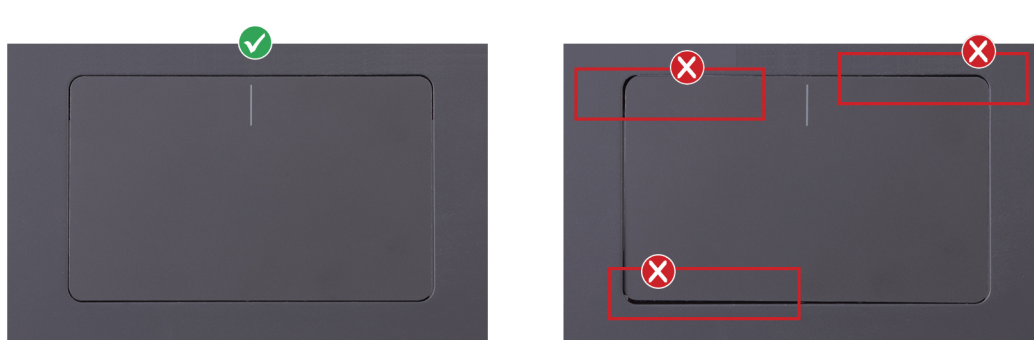

Figure 41. Proper touchpad alignment

2. Replace the nine screws (M1.6x1.8) that secure the touchpad to the palm-rest and keyboard assembly.
 3. Adhere the tape that secures the touchpad to the palm-rest and keyboard assembly.
 4. Fold down the touchpad cable.
 5. Slide the touchpad cable into its connector on the touchpad and close the latch to secure the cable.
 6. Slide the touchpad-light cable into its connector on the touchpad and close the latch to secure the cable.
- NOTE:** Your computer may be shipped with a touchpad-light cable depending on the configuration you have ordered.
7. Fold down the keyboard cable.
 8. Slide the keyboard cable into the connector on the keyboard-controller board and close the latch to secure the cable.
 9. Fold down the keyboard-controller board cable.
 10. Slide the keyboard-controller board cable into the connector on the keyboard-controller board and close the latch to secure the cable.
 11. Align and adhere the Mylar on the keyboard-controller board.
 12. Align and place the speakers onto the palm-rest and keyboard assembly.

Next steps

1. Install the [battery](#).
2. Install the [base cover](#).
3. Follow the procedure in [After working inside your computer](#).

Headset port

Removing the headset port

CAUTION: The information in this removal section is intended for authorized service technicians only.

Prerequisites

1. Follow the procedure in [Before working inside your computer](#).
2. Remove the [base cover](#).
3. Remove the [rear I/O-cover](#).

About this task

The following images indicate the location of the headset port and provide a visual representation of the removal procedure.

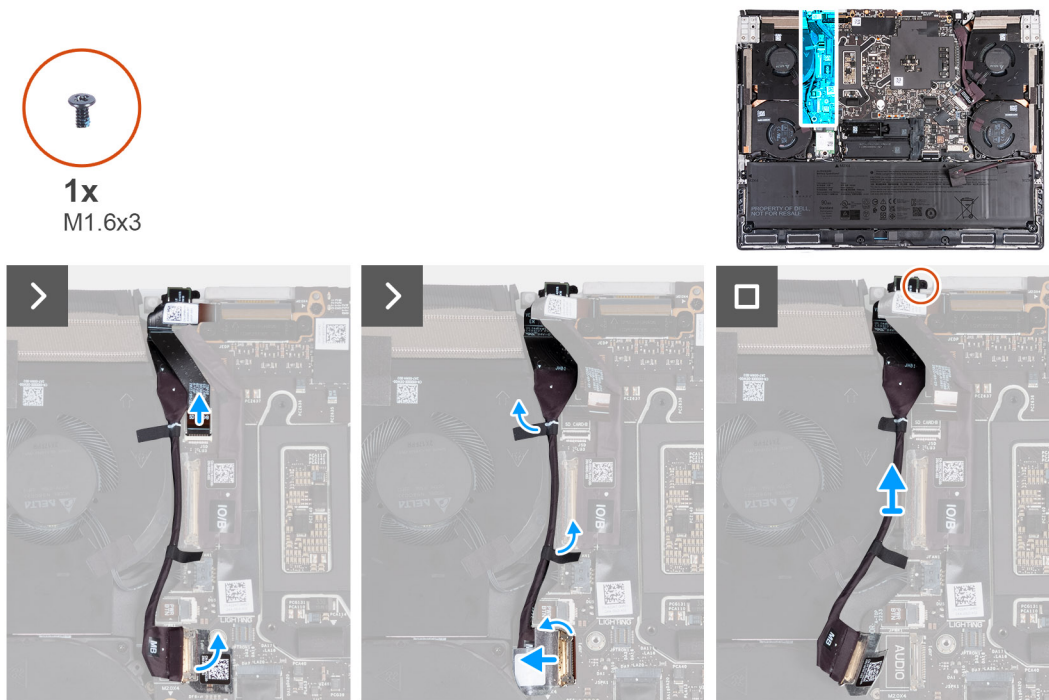

Figure 42. Removing the headset port

Steps

1. Disconnect the microSD-card reader cable from the system board.
2. Peel the tape that secures the headset-port cable to the system board.
3. Open the latch and disconnect the headset-port cable from the system board.
4. Peel the tape that secures the headset-port cable to the fan and heat-sink assembly.
5. Remove the screw (M1.6x3) that secures the headset port to the palm-rest and keyboard assembly.
6. Lift the headset port, along with its cable, from the slot on the palm-rest and keyboard assembly.

Installing the headset port

⚠ CAUTION: The information in this installation section is intended for authorized service technicians only.

Prerequisites

If you are replacing a component, remove the existing component before performing the installation process.

About this task

The following images indicate the location of the headset port and provide a visual representation of the installation procedure.



1x
M1.6x3

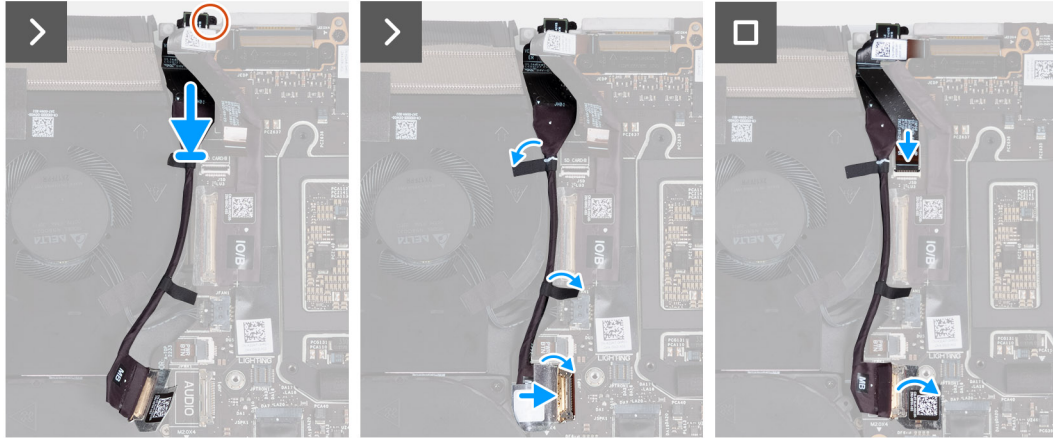
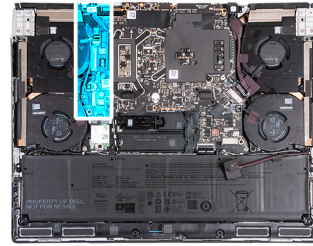

Figure 43. Installing the headset port

Steps

1. Align and place the headset port into the slot on the palm-rest and keyboard assembly.
2. Replace the screw (M1.6x3) that secures the headset port to the palm-rest and keyboard assembly.
3. Adhere the tape that secures the headset-port cable to the fan and heat-sink assembly.
4. Connect the headset-port cable to the system board.
5. Slide the I/O-board cable into the connector on the system board and close the latch to secure the cable.
6. Adhere the tape that secures the I/O-board cable to the system board.
7. Connect the microSD-card reader cable from the system board.

Next steps

1. Install the [rear I/O-cover](#).
2. Install the [base cover](#).
3. Follow the procedure in [After working inside your computer](#).

microSD-card reader

Removing the microSD-card reader

 **CAUTION:** The information in this removal section is intended for authorized service technicians only.

Prerequisites

1. Follow the procedure in [Before working inside your computer](#).
2. Remove the [base cover](#).
3. Remove the [rear I/O-cover](#).

About this task

The following images indicate the location of the microSD-card reader and provide a visual representation of the removal procedure.



2x
M2x2.5

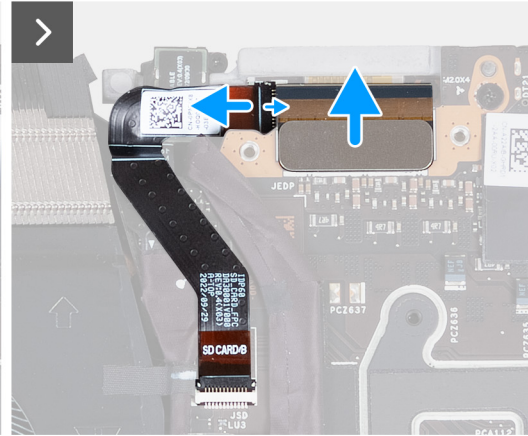
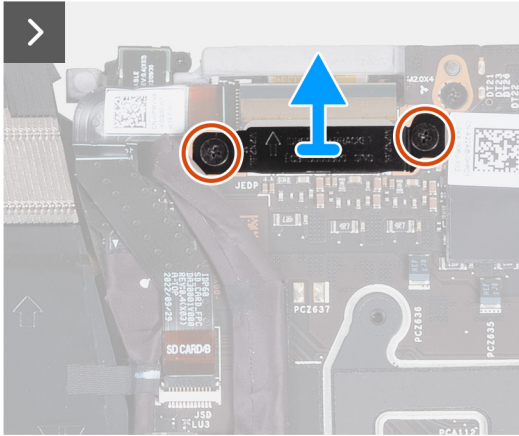
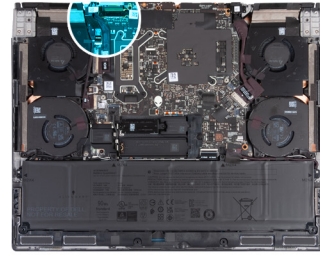

Figure 44. Removing the microSD-card reader



5x
M1.6x3

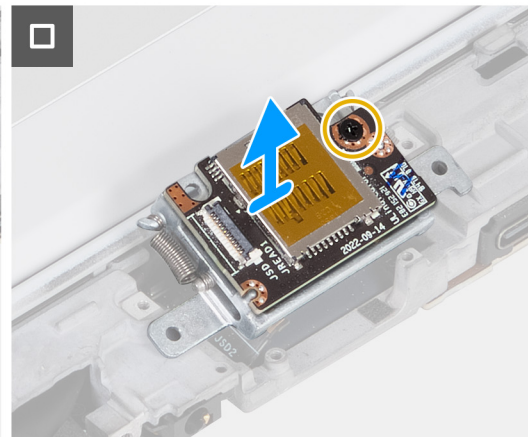
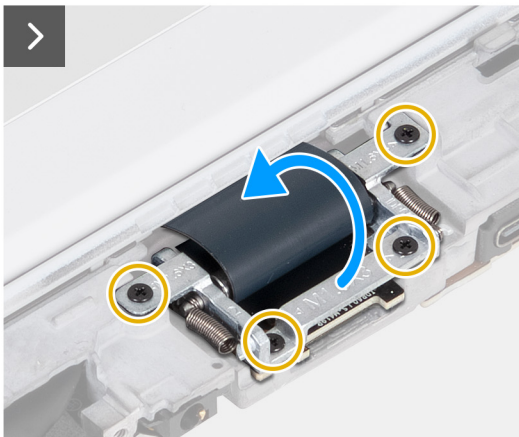

Figure 45. Removing the microSD-card reader

Steps

1. Remove the two screws (M2x2.5) that secures the display-cable bracket to the palm-rest and keyboard assembly.
2. Lift the display-cable bracket off the palm-rest and keyboard assembly.
3. Disconnect the microSD-card reader cable from the microSD-card reader board.
4. Disconnect the display cable from the system board.
5. Turn the computer over.
6. Remove the four screws (M1.6x3) that secure the display-cable holder to the palm-rest and keyboard assembly.

7. Lift the display-cable holder and rotate the display-cable holder to 180 degrees so that the microSD-card reader is visible.
8. Remove the screw (M1.6x3) that secures the microSD-card reader to the display-cable holder.
9. Remove the microSD-card reader from the display-cable holder.

Installing the microSD-card reader

CAUTION: The information in this installation section is intended for authorized service technicians only.

Prerequisites

If you are replacing a component, remove the existing component before performing the installation process.

About this task

The following images indicate the location of the microSD-card reader and provide a visual representation of the installation procedure.

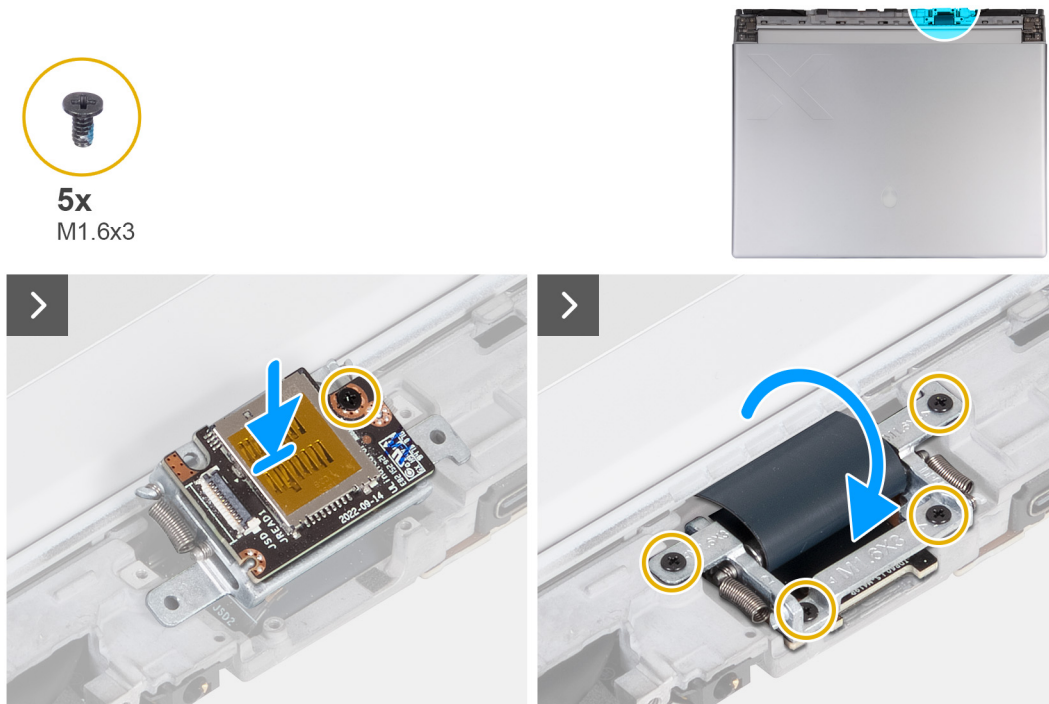

Figure 46. Installing the microSD-card reader

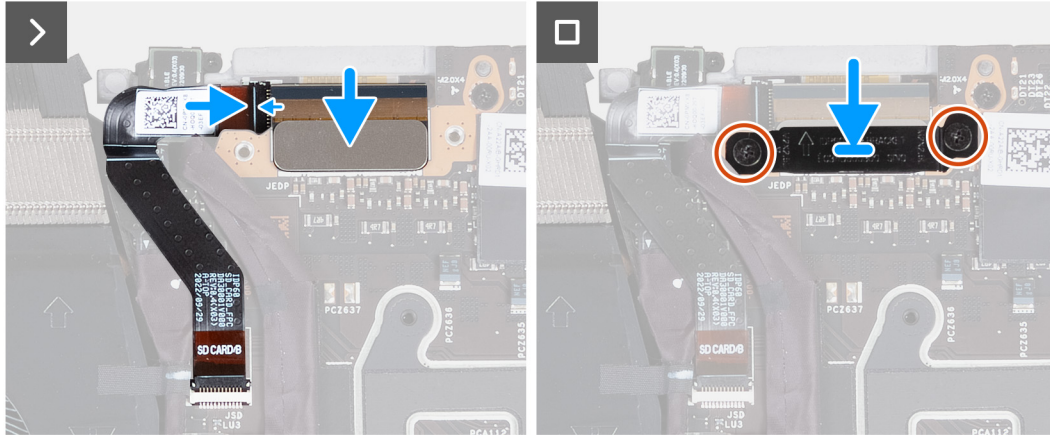
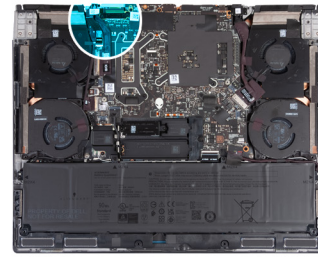

Figure 47. Installing the microSD-card reader

Steps

1. Align the screw hole on the microSD card-reader along with the screw hole on the display-cable holder.
2. Replace the screw (M1.6x3) that secure the microSD-card reader to the display-cable holder.
3. Rotate the display-cable holder to 180 degrees so that the microSD card-reader aligns with the microSD-card reader slot on the palm-rest and keyboard assembly.
4. Replace the four screws (M1.6x3) that secure the microSD-card reader to the display-cable holder.
5. Connect the display cable to the connector on the system board.
6. Connect the microSD-card reader cable to the connector on the microSD-card reader board and close the latch to secure the cable.
7. Align the screw hole on the display-cable bracket to the screw hole on the palm-rest and keyboard assembly.
8. Replace the two screws (M2x2.5) that secure the display-cable bracket to the palm-rest and keyboard assembly.

Next steps

1. Install the [rear I/O-cover](#).
2. Install the [base cover](#).
3. Follow the procedure in [After working inside your computer](#).

Keyboard-controller board

Removing the keyboard-controller board

 **CAUTION:** The information in this removal section is intended for authorized service technicians only.

Prerequisites

1. Follow the procedure in [Before working inside your computer](#).
2. Remove the [base cover](#).
3. Remove the [battery](#).

About this task

The following images indicate the location of the keyboard-controller board and provide a visual representation of the removal procedure.

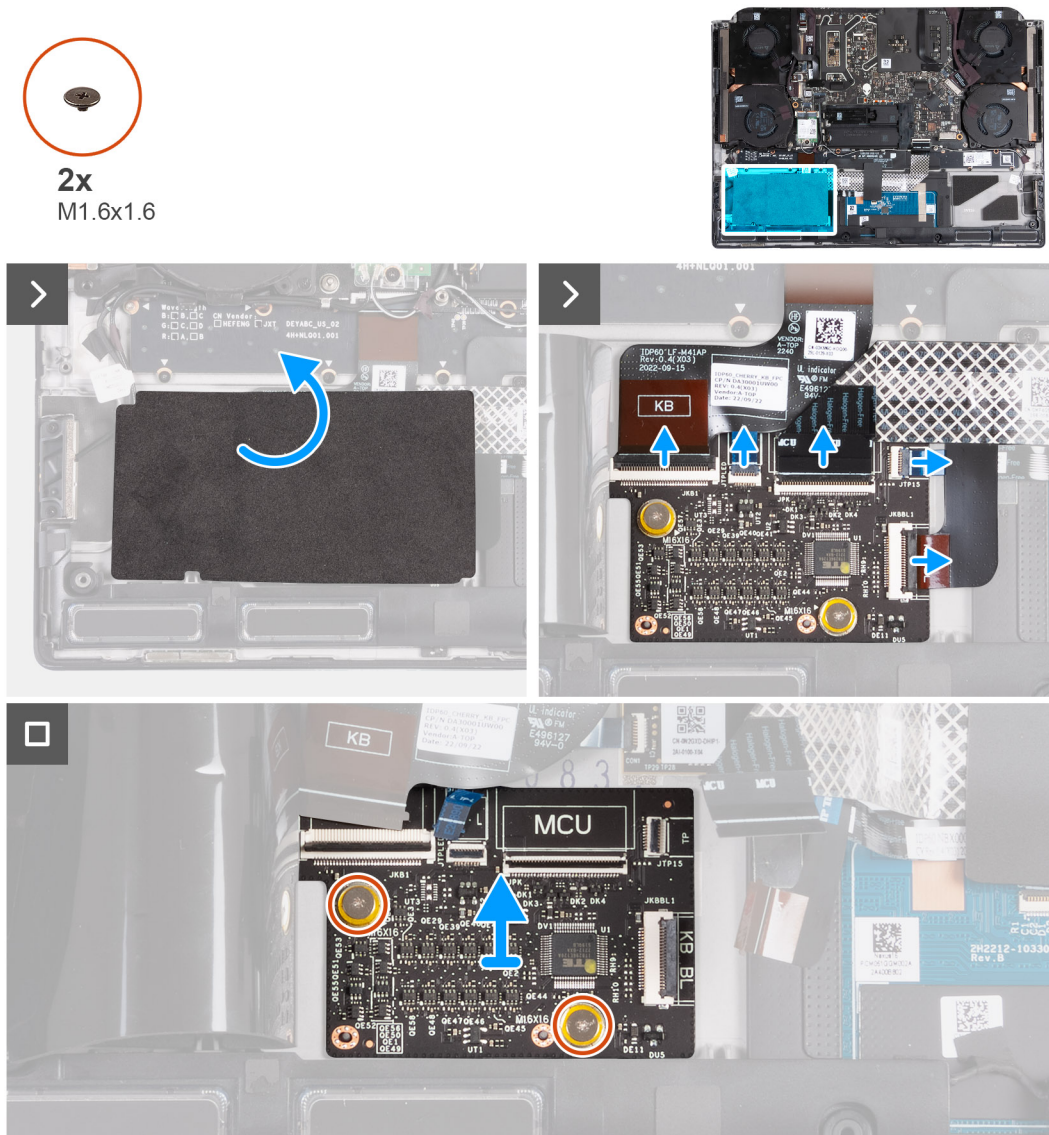

Figure 48. Removing the keyboard-controller board

NOTE: For models shipped with a per-key or mechanical keyboard, the computer will require a keyboard language and keyboard color setup after keyboard-controller board is replaced. When the computer is reassembled and turned on, an error message is displayed. Press F2 to go to the Keyboard section of the BIOS Setup Utility to set up the keyboard language and keyboard color. See the bundled tech sheet for details on configuring the keyboard language.

Steps

1. Lift the Mylar that secures the keyboard-controller board to the palm-rest and keyboard assembly.
2. Open the latch and disconnect the keyboard-backlight cable from the keyboard-controller board.
3. Open the latch and disconnect the touchpad-light cable from the keyboard-controller board.

NOTE: Your computer may be shipped with a touchpad-light cable depending on the configuration you have ordered.

4. Open the latch and disconnect the keyboard-controller board cable from the keyboard-controller board.
5. Open the latch and disconnect the touchpad cable from the keyboard-controller board.
6. Open the latch and disconnect the keyboard cable from the keyboard-controller board.

7. Remove the two screws (M1.6x1.6) that secure the keyboard-controller board to the palm-rest and keyboard assembly.
8. Lift the keyboard-controller board off the palm-rest and keyboard assembly.

Installing the keyboard-controller board

CAUTION: The information in this installation section is intended for authorized service technicians only.

Prerequisites

If you are replacing a component, remove the existing component before performing the installation process.

About this task

The following images indicate the location of the keyboard-controller board and provide a visual representation of the installation procedure.

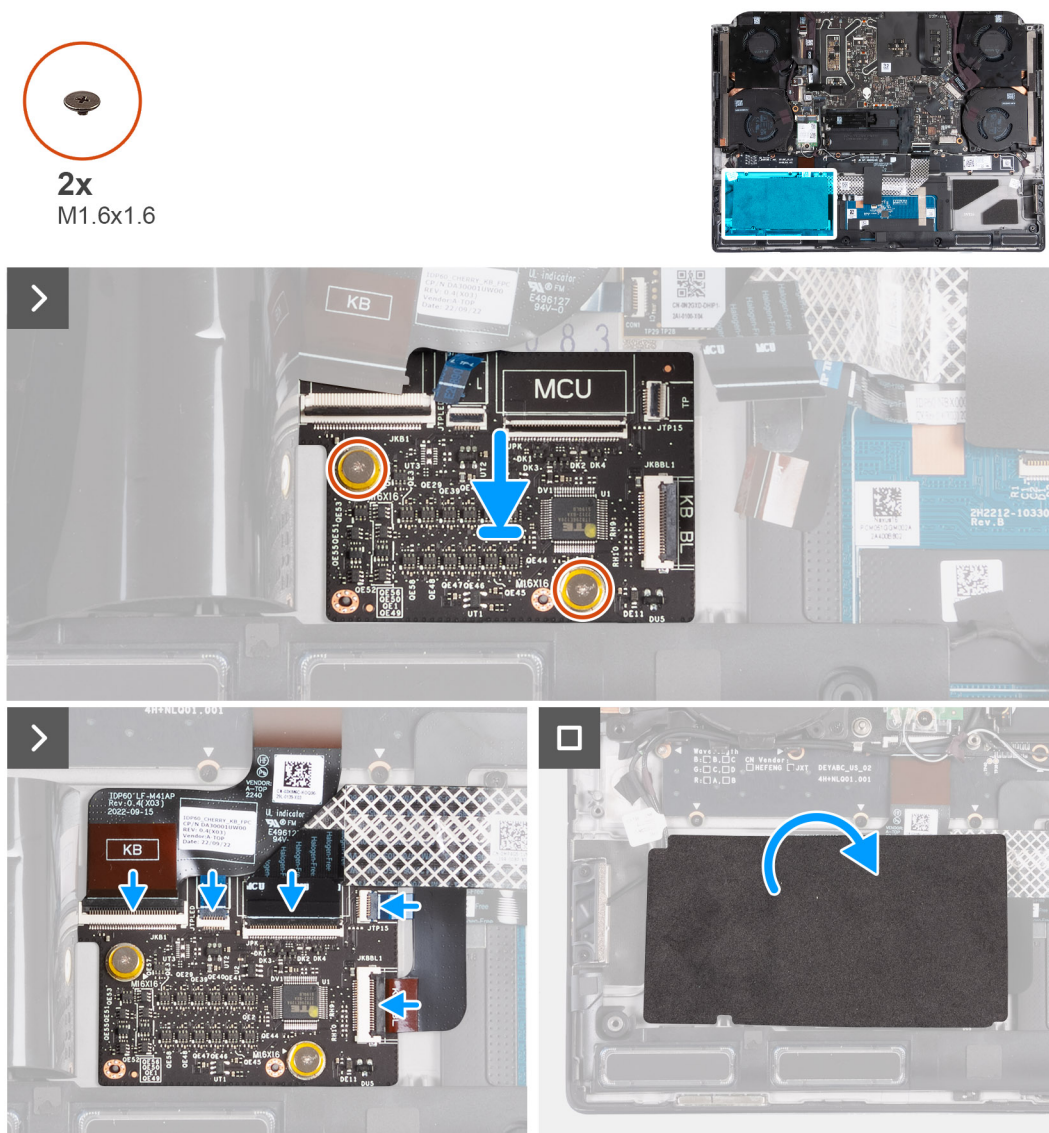

Figure 49. Installing the keyboard-controller board

Steps

1. Using the alignment posts, place the keyboard-controller board into the slot on the palm-rest and keyboard assembly.
2. Replace the two screws (M1.6x1.6) that secure the keyboard-controller board to the palm-rest and keyboard assembly.

3. Slide the keyboard cable into the connector on the keyboard-controller board and close the latch to secure the cable.
4. Slide the touchpad cable into the connector on the keyboard-controller board and close the latch to secure the cable.
5. Slide the keyboard-controller board cable into the connector on the keyboard-controller board and close the latch to secure the cable.
6. Slide the touchpad-light cable into the connector on the keyboard-controller board and close the latch to secure the cable.
i **NOTE:** Your computer may be shipped with a touchpad-light cable depending on the configuration you have ordered.
7. Slide the keyboard-backlight cable into the connector on the keyboard-controller board and close the latch to secure the cable.
8. Place the Mylar that secures the keyboard-controller board to the palm-rest and keyboard assembly.
i **NOTE:** For models shipped with a per-key or mechanical keyboard, the computer will require a keyboard language and keyboard color setup after keyboard-controller board is replaced. When the computer is reassembled and turned on, an error message is displayed. Press F2 to go to the Keyboard section of the BIOS Setup Utility to set up the keyboard language and keyboard color. See the bundled Tech Sheet for details on configuring the keyboard language.

Next steps

1. Install the [battery](#).
2. Install the [base cover](#).
3. Follow the procedure in [After working inside your computer](#).

Display assembly

Removing the display assembly

⚠ CAUTION: The information in this removal section is intended for authorized service technicians only.

Prerequisites

1. Follow the procedure in [Before working inside your computer](#).
2. Remove the [base cover](#).
3. Remove the [rear I/O-cover](#).

About this task

i **NOTE:** The display assembly is a Hinge-Up Display (HUD) and cannot be further disassembled.

The following images indicate the location of the display assembly and provide a visual representation of the removal procedure.



8x
M2.5x4



2x
M2x2.5

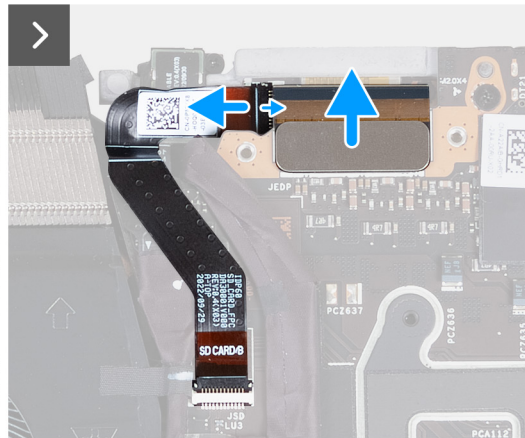
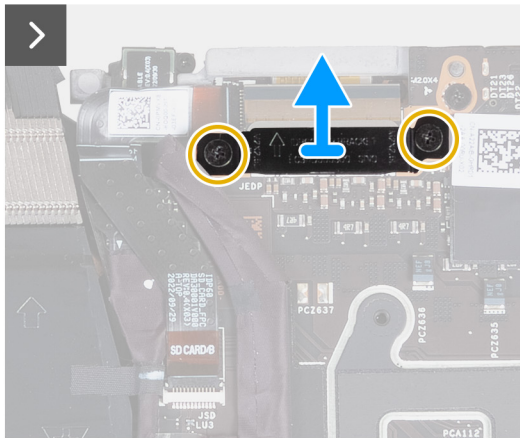
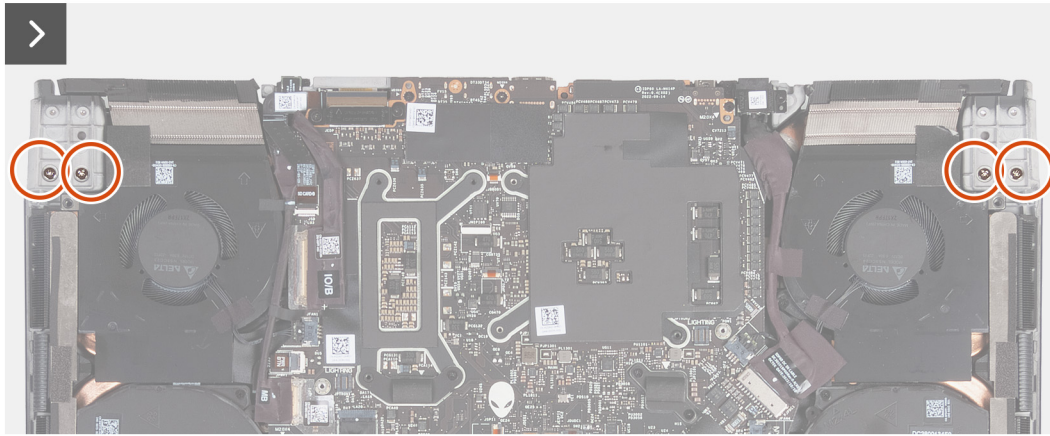
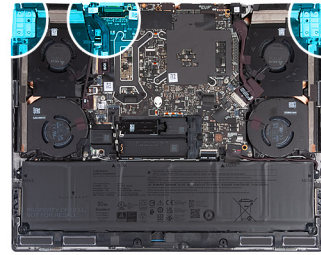

Figure 50. Removing the display assembly



5x
M1.6x3

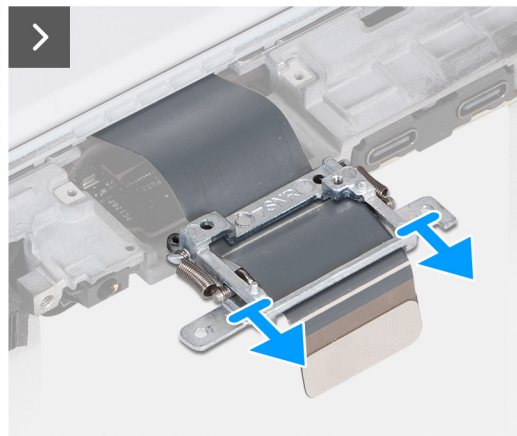
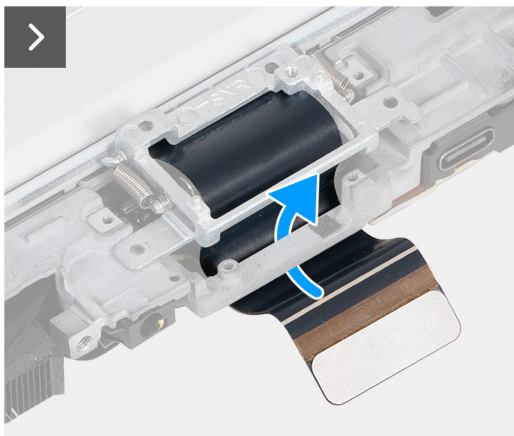
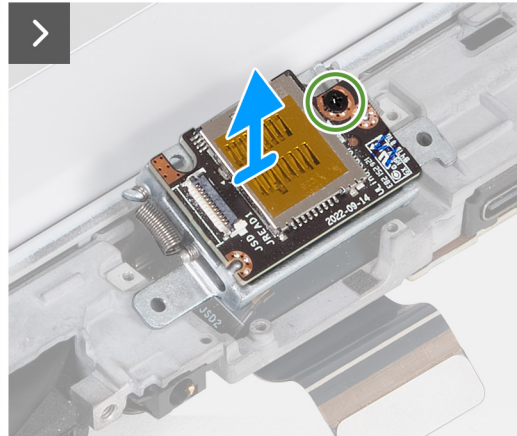
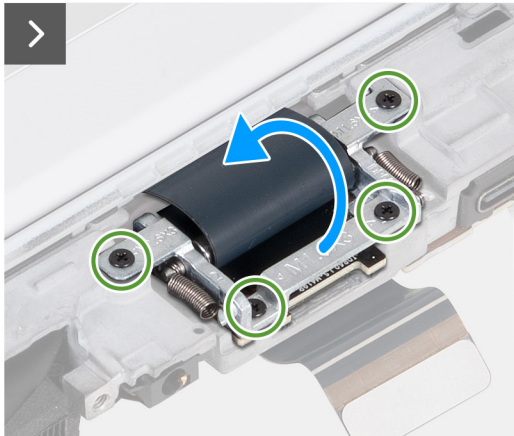

Figure 51. Removing the display assembly



Figure 52. Removing the display assembly

Steps

1. Remove the four screws (M2.5x4) that secure the left and right display hinge to the bottom side of the palm-rest and keyboard assembly.
2. Remove the two screws (M2x2.5) that secures the display-cable bracket to the palm-rest and keyboard assembly.
3. Lift the display-cable bracket off the palm-rest and keyboard assembly.
4. Disconnect the microSD-card reader cable from the microSD-card reader board.
5. Disconnect the display cable from the system board.
6. Turn the computer over.
7. Remove the four screws (M1.6x3) that secures the display-cable holder to the palm-rest and keyboard assembly.
8. Lift the display-cable holder and rotate the display-cable holder to 180 degrees so that the microSD-card reader is visible.
9. Remove the screw (M1.6x3) that secures the microSD-card reader to the display-cable holder.
10. Remove the microSD-card reader from the display-cable holder.
11. Slide and remove the display-cable holder off the palm-rest and keyboard assembly.

NOTE: While removing the display cable from the display cable holder, push open the spring-loaded bar separating the two slits in the middle of the display holder.

12. Route the display cable from the slot between the palm-rest and keyboard assembly and rear I/O cover.

13. Remove the four screws (M2.5x4) that secure the left and right display hinge to the top side of the palm-rest and keyboard assembly.
14. Lift the display assembly off the palm-rest and keyboard assembly.
15. After performing the steps above, you are left with the display assembly.



Figure 53. Display assembly

Installing the display assembly

△ **CAUTION:** The information in this installation section is intended for authorized service technicians only.

Prerequisites

If you are replacing a component, remove the existing component before performing the installation process.

About this task

△ **CAUTION:** Place the computer on a soft and clean surface to avoid scratching the display.

The following images indicate the location of the display assembly and provide a visual representation of the installation procedure.

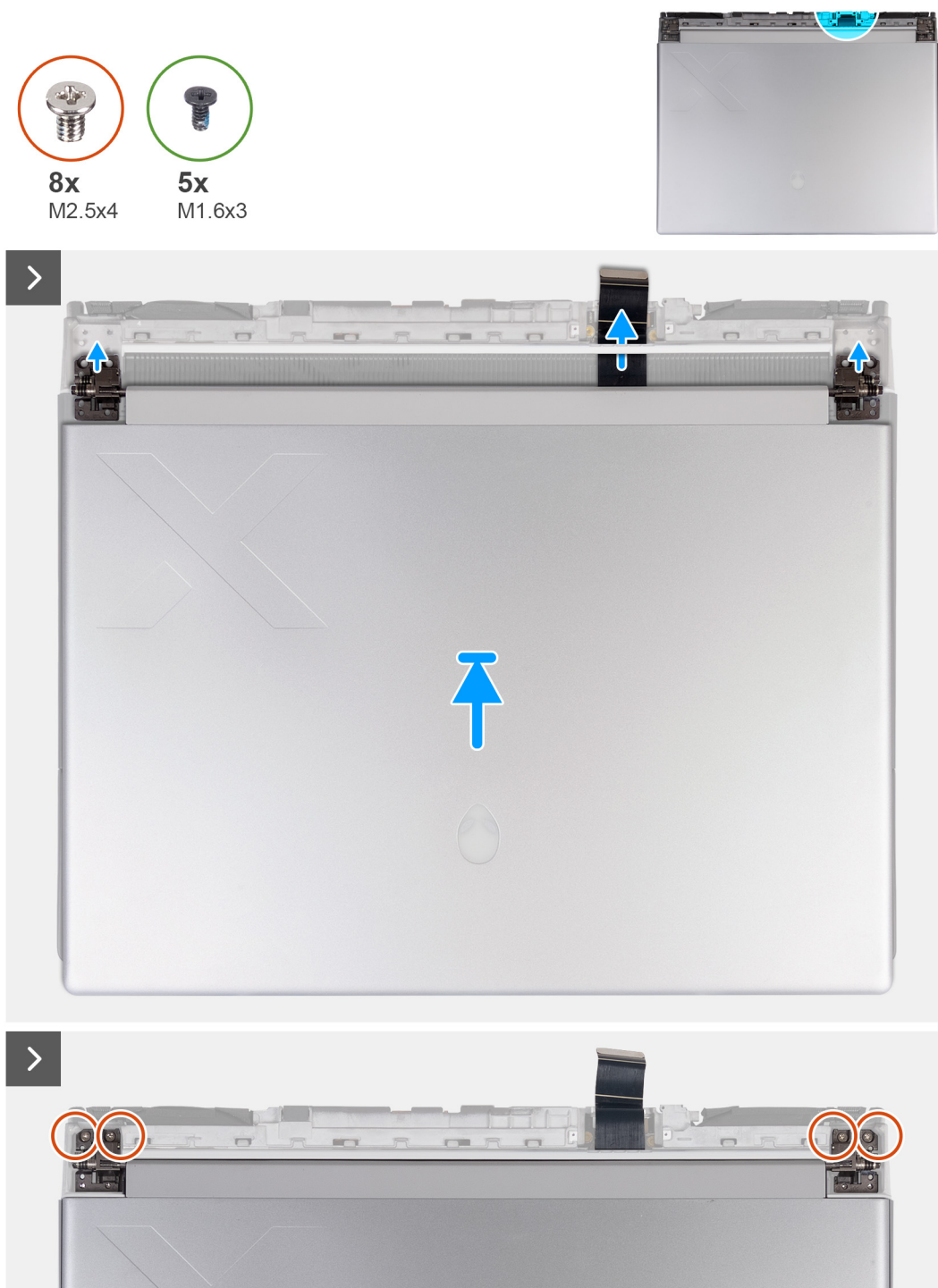

Figure 54. Installing the display assembly

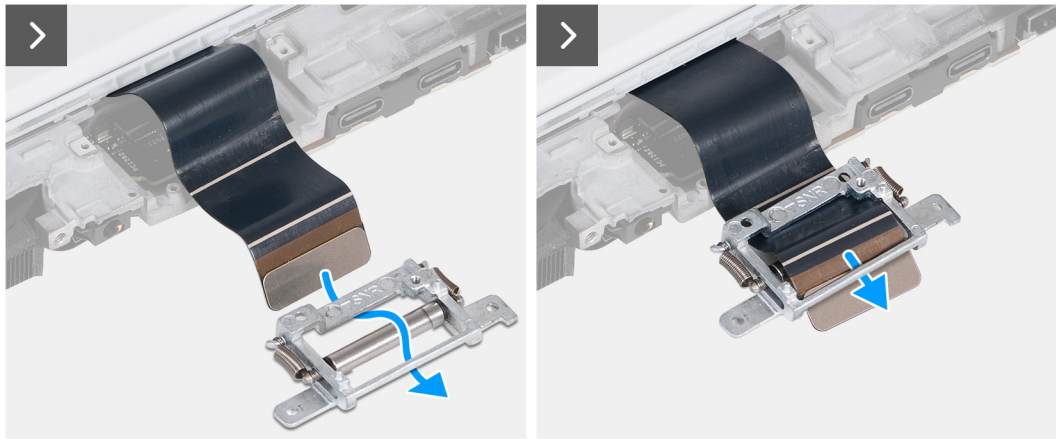

Figure 55. Installing the display assembly

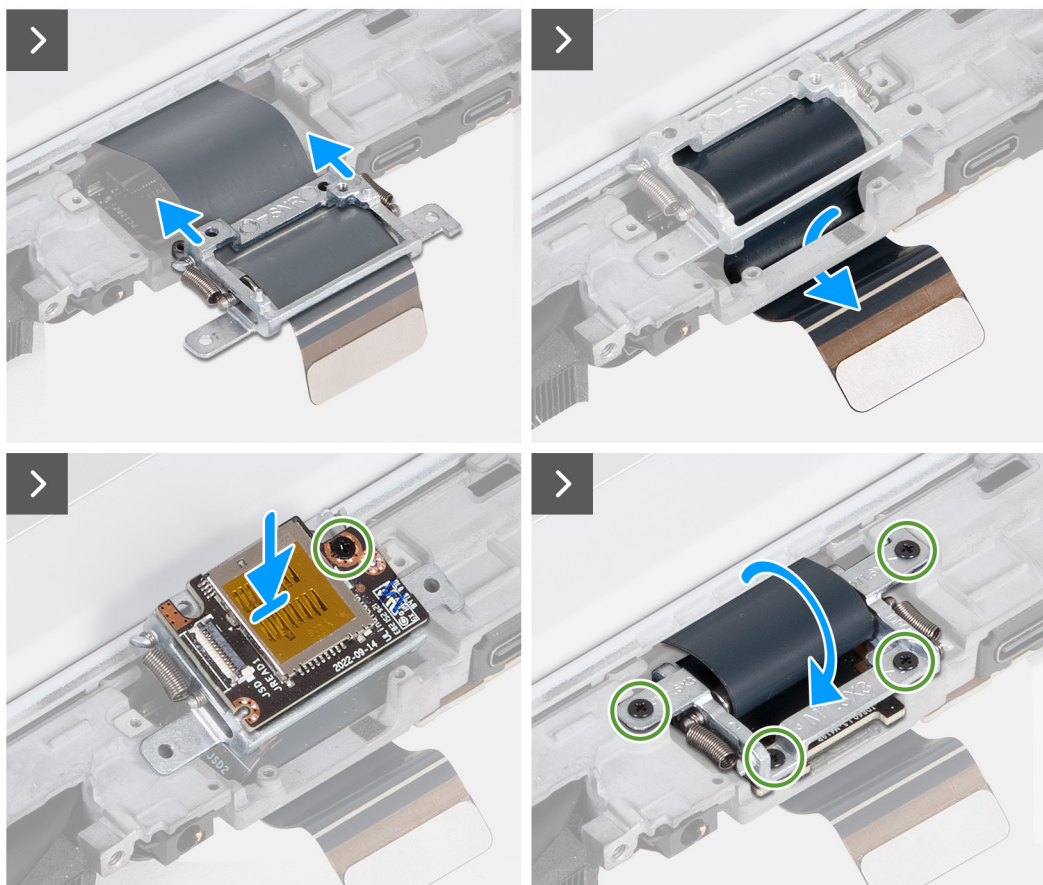

Figure 56. Installing the display assembly



2x
M2x2.5

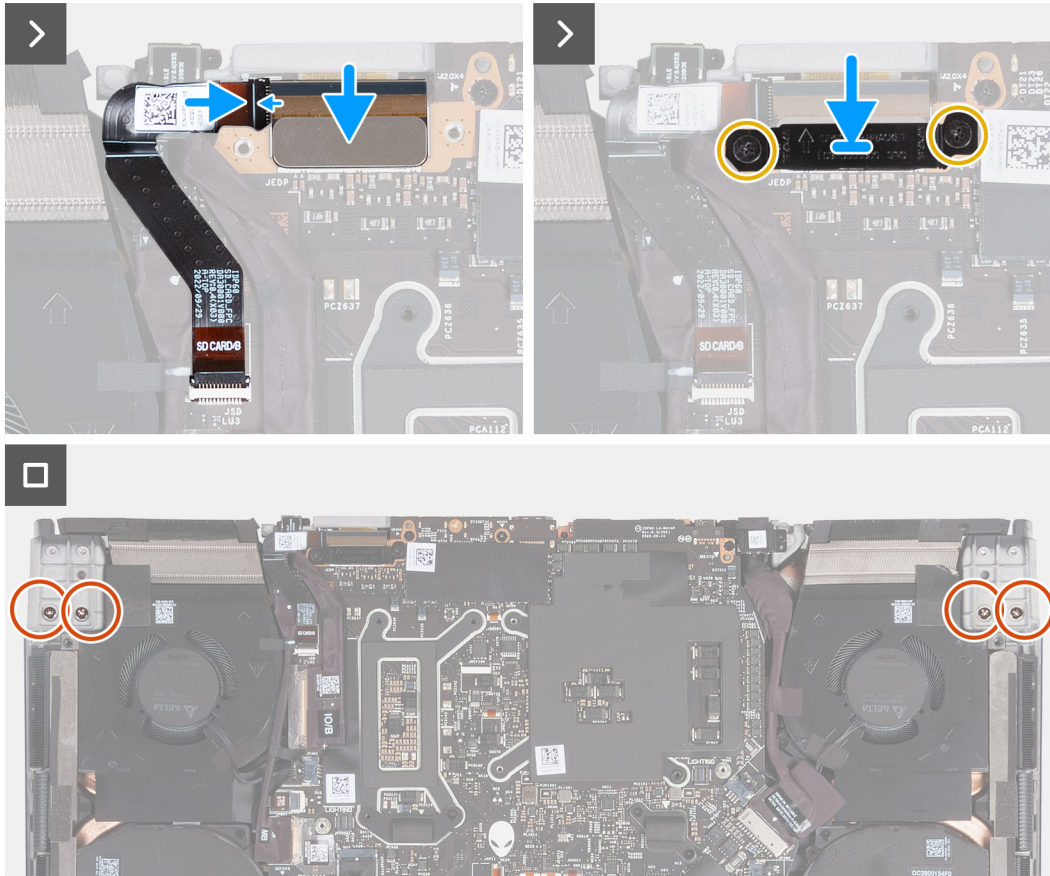
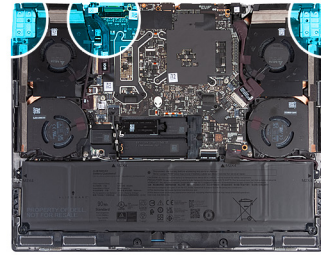



Figure 57. Installing the display assembly

NOTE: Place the computer on a soft and clean surface to avoid scratching the display.

Steps

1. Align the screw holes on the display assembly with the screw holes on the palm-rest and keyboard assembly.
2. Gently slide the display cable through the plastic strip between the palm-rest and keyboard assembly and rear-I/O cover.
3. Route the display cable through the slit on the other side of the rear-I/O cover.
NOTE: The display cable must be routed under the rear-I/O cover in order to properly install the display assembly. Failing to do so damages the display cable.
4. Replace the four screws (M2.5x4) that secure the left and right display hinge to the top side of the palm-rest and keyboard assembly.
NOTE: If the display is not fully closed, you cannot install the display-cable holder correctly.
5. Slide the display-cable holder so that the triangle mark on the display cable aligns with the triangle mark on the display-cable holder.
6. From the bottom of the display-cable holder, route the display cable into the opening that is next to the triangle mark.
7. Slide the display cable over the bar on the display-cable holder and into the opening on the other side of the holder.

8. Slide the display-cable holder towards the display assembly until the display-cable holder is aligned against the rear-I/O cover.
 9. Align the screw hole on the microSD card-reader along with the screw hole on the display-cable holder.
 10. Replace the screw (M1.6x3) that secures the microSD-card reader to the display-cable holder.
 11. Route the display cable through the opening on the rear side of the palm-rest and keyboard assembly.
 12. Rotate the display-cable holder to 180 degrees so that the microSD card-reader aligns with the microSD-card reader slot on the palm-rest and keyboard assembly.
 13. Place the display-cable holder on the slot of the palm-rest and keyboard assembly.
 14. Replace the four screws (M1.6x3) that secure the display-cable holder to the palm-rest and keyboard assembly.
 15. Turn the computer over.
 16. Slide the microSD card-reader cable onto the connector on the microSD-card reader board and close the latch to secure the cable.
 17. Align the screw holes on the display assembly with the screw holes on the left and right display hinge on the bottom side of the palm-rest and keyboard assembly.
 18. Replace the four screws (M2.5x4) that secure the left and right display hinge to the bottom side of the palm-rest and keyboard assembly.
 19. Slide the display cable onto the connector on the system board.
 20. Replace the two screws (M2x2.5) that secures the display-cable bracket to the palm-rest and keyboard assembly.
-  **NOTE:** Check to ensure that the display cable is routed and installed correctly with the display cable holder. If the display cable is visible between the gaps of the display assembly, the installation is incorrect.

Next steps

1. Install the [rear I/O-cover](#).
2. Install the [base cover](#).
3. Follow the procedure in [After working inside your computer](#).

Antennas

Removing the antennas

 **CAUTION:** The information in this removal section is intended for authorized service technicians only.

Prerequisites

1. Follow the procedure in [Before working inside your computer](#).
2. Remove the [base cover](#).
3. Remove the [battery](#).
4. Remove the [wireless card](#).

About this task

The following images indicate the location of the antennas and provide a visual representation of the removal procedure.



4x
M1.6x3

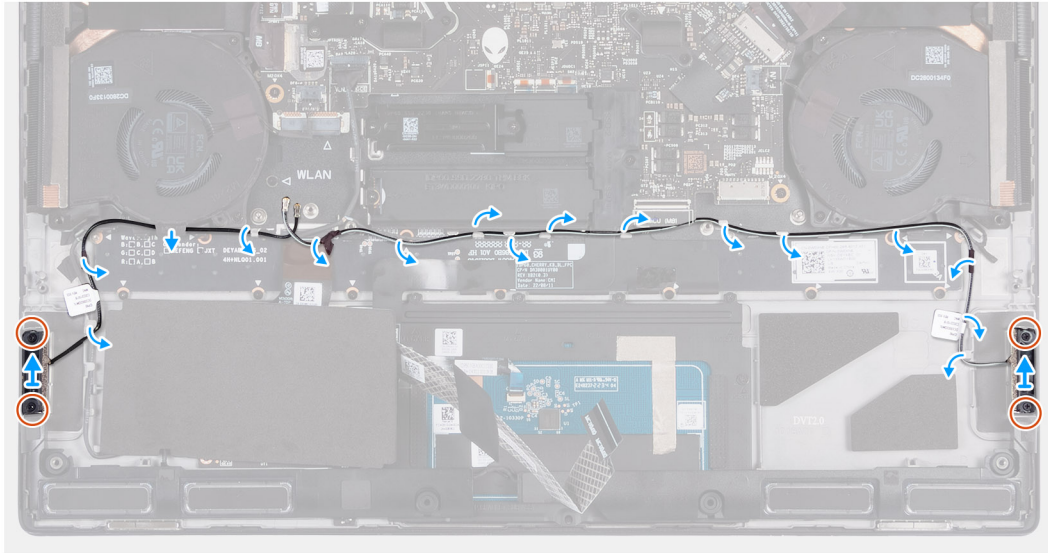
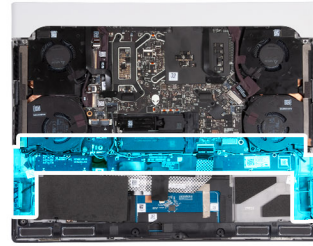

Figure 58. Removing the antennas

Steps

1. Remove the four screws (M1.6x3) that secures the left and right antennas to the palm-rest and keyboard assembly.
2. Peel the tape that secures the antenna cables to the palm-rest and keyboard assembly.
3. Remove the antenna cables from the routing guides on the palm-rest and keyboard assembly.
4. Lift the left and right antennas, along with the antenna cables, off the palm-rest and keyboard assembly.

Installing the antennas

⚠ CAUTION: The information in this installation section is intended for authorized service technicians only.

Prerequisites

If you are replacing a component, remove the existing component before performing the installation process.

About this task

The following images indicate the location of the antennas and provide a visual representation of the installation procedure.



4x
M1.6x3

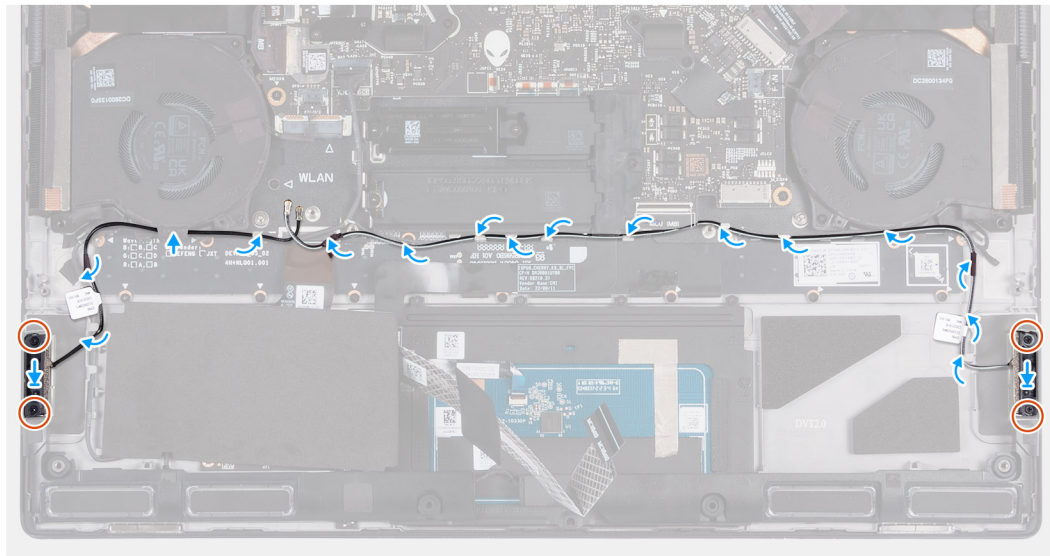
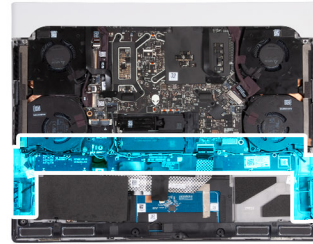

Figure 59. Installing the antennas

Steps

1. Align and place the left and right antennas on the slot on the palm-rest and keyboard assembly.
2. Route the antenna cables onto the routing guides on the palm-rest and keyboard assembly.
3. Adhere the tape that secures the antenna cables to the palm-rest and keyboard assembly.
4. Replace the four screws (M1.6x3) that secures the left and right antennas to the palm-rest and keyboard assembly.

Next steps

1. Install the [wireless card](#).
2. Install the [battery](#).
3. Install the [base cover](#).
4. Follow the procedure in [After working inside your computer](#).

Processor fan

Removing the processor fan

⚠ **CAUTION:** The information in this removal section is intended for authorized service technicians only.

Prerequisites

1. Follow the procedure in [Before working inside your computer](#).
2. Remove the [base cover](#).
3. Remove the [wireless card](#).

About this task

The following images indicate the location of the processor fan and provide a visual representation of the removal procedure.

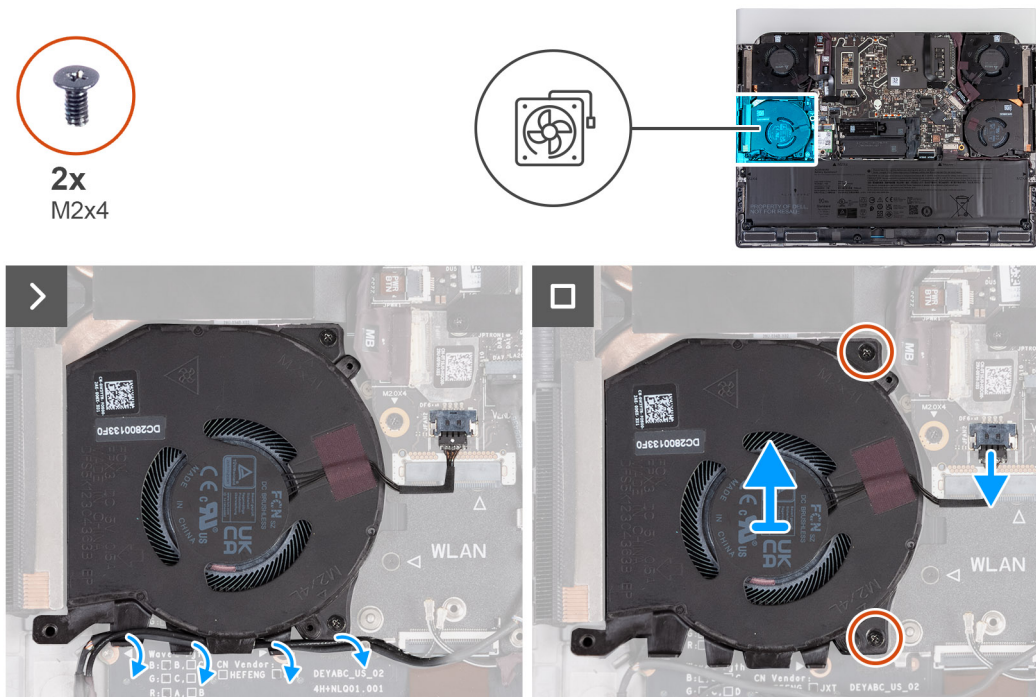

Figure 60. Removing the processor fan

Steps

1. Disconnect the processor-fan cable and speaker cable from the system board.
2. Remove the speaker cable and the antenna cables through the routing guides on the bottom of the processor fan.
3. Remove the two screws (M2x4) that secure the processor fan to the palm-rest and keyboard assembly.
4. Lift the processor fan off the palm-rest and keyboard assembly.

Installing the processor fan

CAUTION: The information in this installation section is intended for authorized service technicians only.

Prerequisites

If you are replacing a component, remove the existing component before performing the installation process.

About this task

The following images indicate the location of the processor fan and provide a visual representation of the installation procedure.

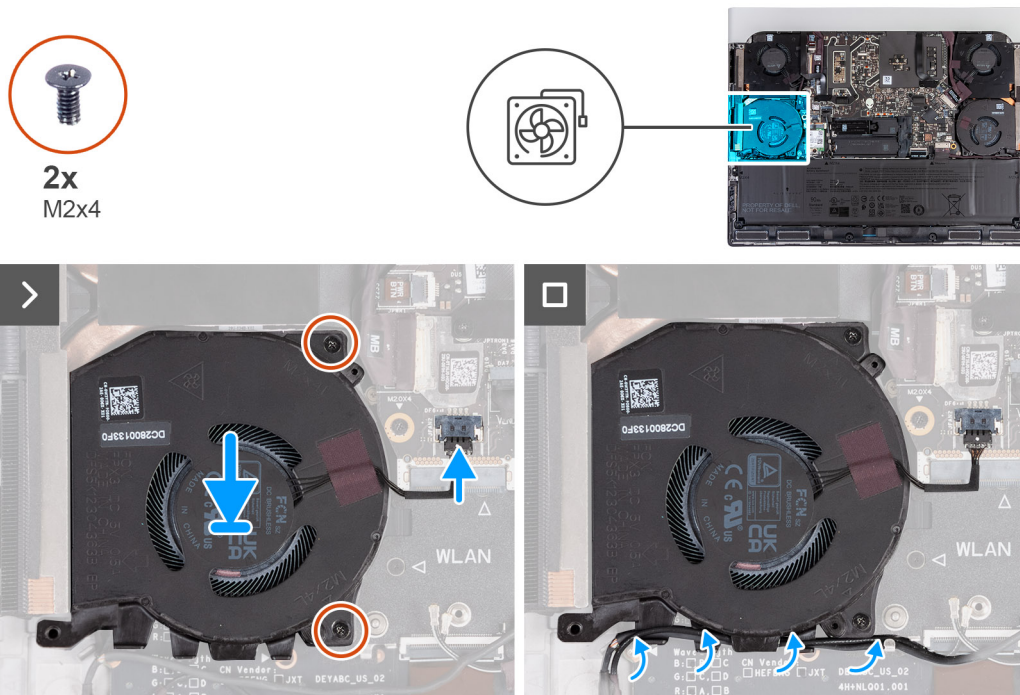

Figure 61. Installing the processor fan

Steps

1. Align and place the processor fan into the slot on the palm-rest and keyboard assembly.
2. Replace the two screws (M2x4) that secure the processor fan to the palm-rest and keyboard assembly.
3. Route the speaker cable and the antenna cable through the routing guides on the bottom of the processor fan.
4. Connect the processor-fan cable and speaker cable to the system board.

Next steps

1. Install the [wireless card](#).
2. Install the [base cover](#).
3. Follow the procedure in [After working inside your computer](#).

Graphics-card fan

Removing the graphics-card fan

⚠ CAUTION: The information in this removal section is intended for authorized service technicians only.

Prerequisites

1. Follow the procedure in [Before working inside your computer](#).
2. Remove the [base cover](#).

About this task

The following images indicate the location of the graphics-card fan and provide a visual representation of the removal procedure.

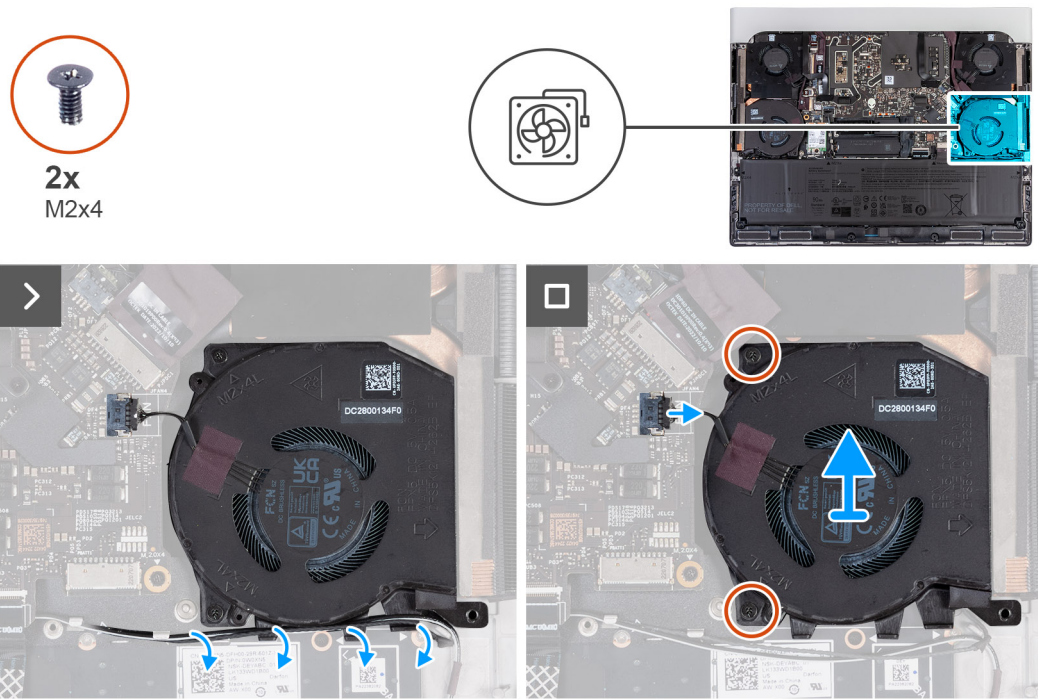

Figure 62. Removing the graphics-card fan

Steps

1. Disconnect the graphics-card fan cable from the system board.
2. Remove the speaker cable and antenna cables from the routing guides on the bottom of the graphics-card fan.
3. Remove the two screws (M2x4) that secure the graphics-card fan to the palm-rest and keyboard assembly.
4. Lift the graphics-card fan off the palm-rest and keyboard assembly.

Installing the graphics-card fan

⚠ CAUTION: The information in this installation section is intended for authorized service technicians only.

Prerequisites

If you are replacing a component, remove the existing component before performing the installation process.

About this task

The following images indicate the location of the graphics-card fan and provide a visual representation of the installation procedure.

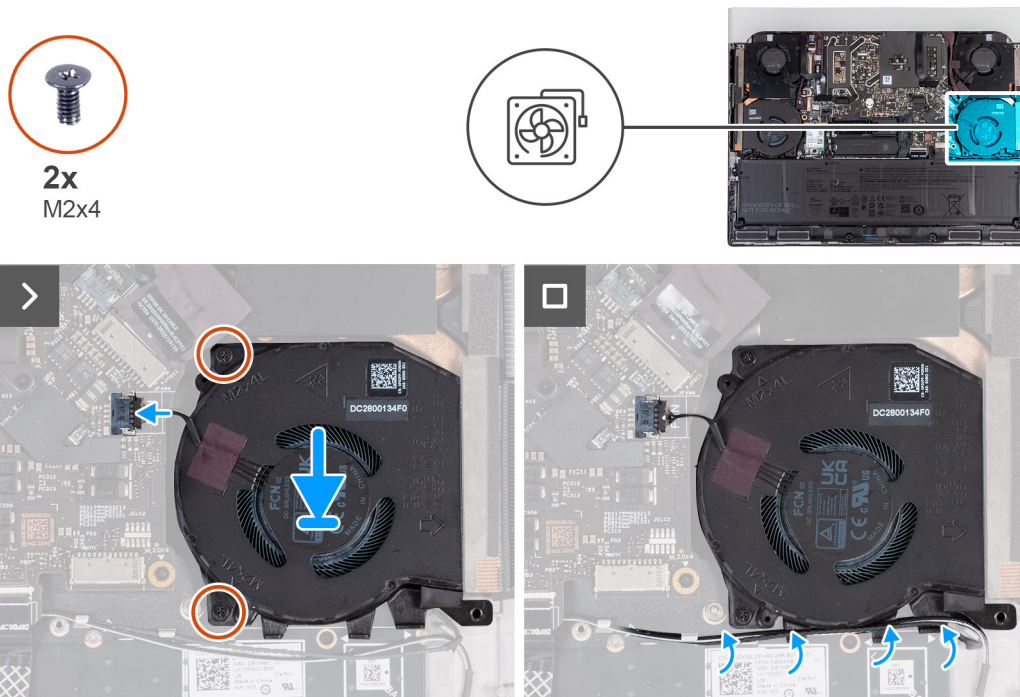

Figure 63. Installing the graphics-card fan

Steps

1. Align and place the graphics-card fan into the slot on the palm-rest and keyboard assembly.
2. Connect the graphics-card fan cable to the system board.
3. Replace the two screws (M2x4) that secure the graphics-card fan to the palm-rest and keyboard assembly.
4. Route the speaker cable and the antenna cable through the routing guides on the bottom of the graphics-card fan.

Next steps

1. Install the [base cover](#).
2. Follow the procedure in [After working inside your computer](#).

Power-adapter port

Removing the power-adapter port

CAUTION: The information in this removal section is intended for authorized service technicians only.

Prerequisites

1. Follow the procedure in [Before working inside your computer](#).
2. Remove the [base cover](#).
3. Remove the [rear I/O-cover](#).

About this task

The following images indicate the location of the power-adapter port and provide a visual representation of the removal procedure.

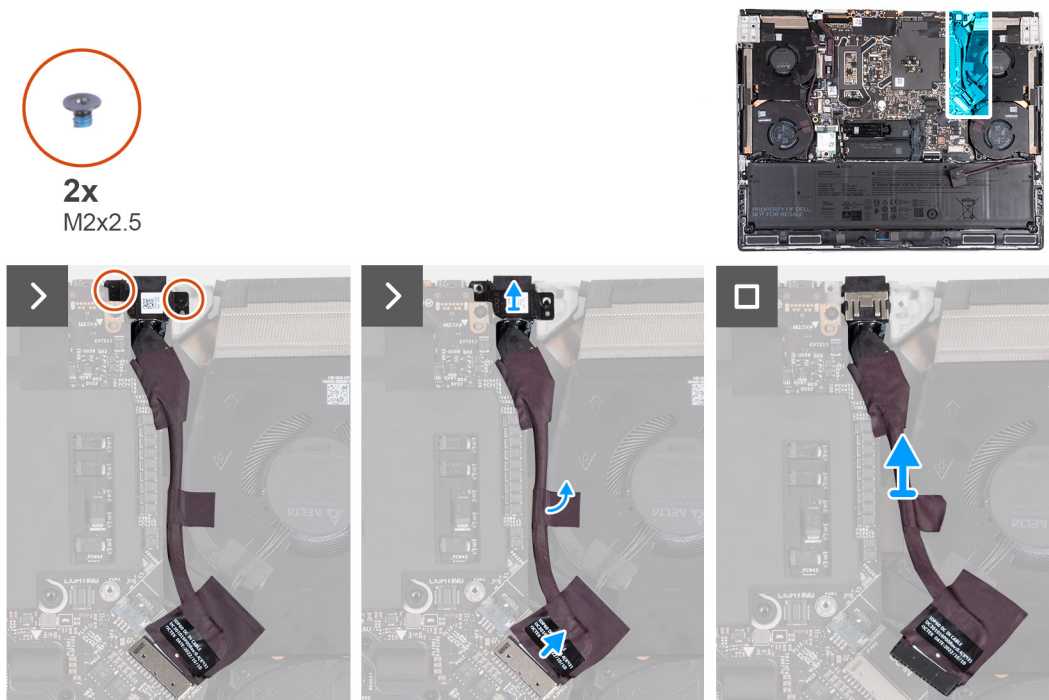

Figure 64. Removing the power-adapter port

Steps

1. Remove the two screws (M2x2.5) that secure the power-adapter port bracket to the palm-rest and keyboard assembly.
2. Lift the power-adapter port bracket off the palm-rest and keyboard assembly.
3. Using the pull tab, disconnect the power-adapter port cable from the system board.
4. Peel the tape that secures the power-adapter port cable to the fan and heat-sink assembly.
5. Lift the power-adapter port, along with its cable, off the palm-rest and keyboard assembly.

Installing the power-adapter port

CAUTION: The information in this installation section is intended for authorized service technicians only.

Prerequisites

If you are replacing a component, remove the existing component before performing the installation process.

About this task

The following images indicate the location of the power-adapter port and provide a visual representation of the installation procedure.

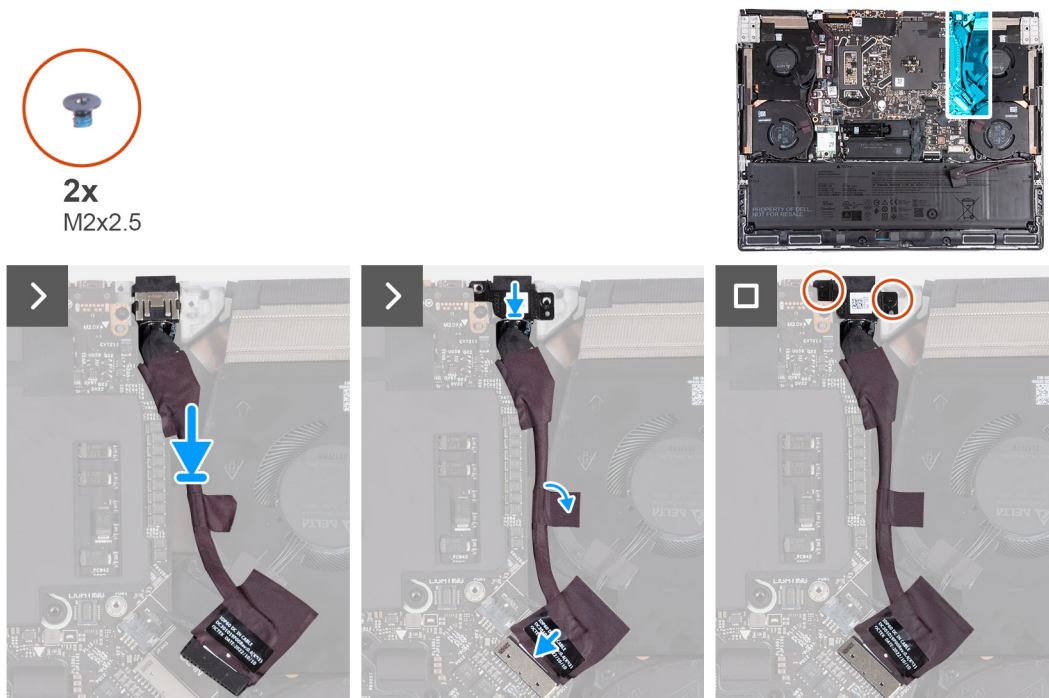

Figure 65. Installing the power-adapter port

Steps

1. Align and place the power-adapter port into the slot on the palm-rest and keyboard assembly.
2. Connect the power-adapter port cable to the system board.
3. Adhere the tape that secures the power-adapter port to the fan and heat-sink assembly.
4. Route the power-adapter port cable through the routing guides on the fan and heat-sink assembly.
5. Place the power-adapter port bracket on the power-adapter port.
6. Align the screw holes on the power-adapter port bracket with the screw holes on the palm-rest and keyboard assembly.
7. Replace the two screws (M2x2.5) that secure the power-adapter port bracket to the palm-rest and keyboard assembly.

Next steps

1. Install the [rear I/O-cover](#).
2. Install the [base cover](#).
3. Follow the procedure in [After working inside your computer](#).

System board

Removing the system board

CAUTION: The information in this removal section is intended for authorized service technicians only.

Prerequisites

1. Follow the procedure in [Before working inside your computer](#).
2. Remove the [base cover](#).
3. Remove the [battery](#).
4. Remove the [wireless card](#).
5. Remove the [M.2 2230 solid state drive](#) or [M.2 2280 solid state drive](#), as applicable.
6. Remove the [solid state drive bracket](#).
7. Remove the [processor fan](#).

8. Remove the [graphics-card fan](#).
9. Remove the [rear I/O-cover](#).
10. Remove the [power-adaptor port](#).

About this task

NOTE: When installing this component, see the tech sheet that is bundled with the service kit. The presence of Element 31 grease in the computer depends on the discrete Graphics Processing Unit (GPU) configuration installed.

To determine if your computer has Element 31 grease that is applied on the CPU or GPU, see the following table.

Table 26. CPU or GPU supporting Element 31 grease

GPU	Element 31 grease
NVIDIA GeForce RTX 4060	Present in GPU only
NVIDIA GeForce RTX 4070	Present in GPU only
NVIDIA GeForce RTX 4080	Present in both CPU and GPU
NVIDIA GeForce RTX 4090	Present in both CPU and GPU

NOTE: Computers that are shipped with NVIDIA GeForce RTX 4060/4070 graphics card support one M.2 2230 and one M.2 2280 solid state drive slot, whereas computers shipped with NVIDIA GeForce RTX 4080/4090 graphics card support two M.2 2280 solid state drive slots.

The following image indicates the connectors on your system board.

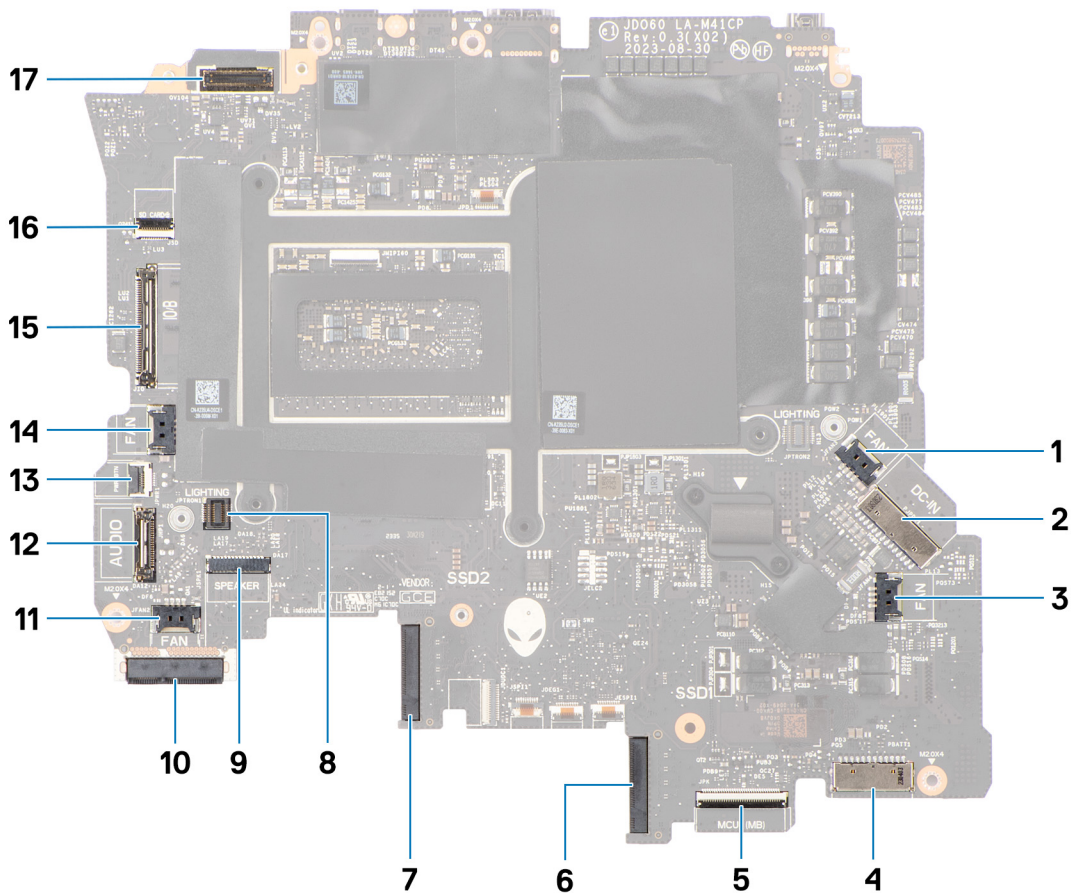

Figure 66. System board callout

1. Right-fan cable connector
2. Power-adapter port cable connector
3. Graphics-card fan cable connector
4. Battery-cable connector
5. Keyboard-controller board cable connector
6. Solid state drive slot 1 (SSD-1)
7. Solid state drive slot 2 (SSD-2)
8. Left tron-light cable connector
9. Speaker-cable connector
10. WLAN card
11. Processor-fan cable connector
12. Headset-port connector
13. Power-button cable connector
14. Left-fan cable connector
15. I/O-board cable connector
16. Micro-SD-card reader cable connector
17. Display-cable connector

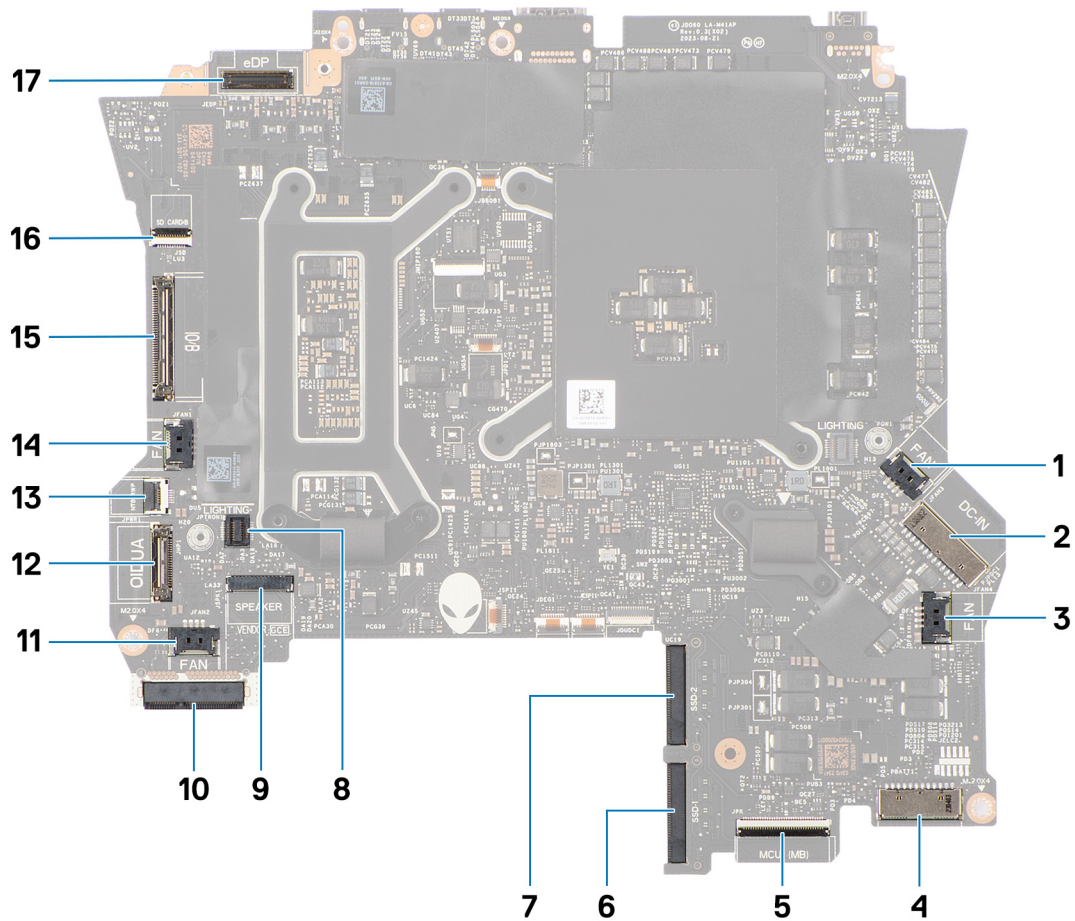

Figure 67. System board callout

1. Right-fan cable connector
2. Power-adapter port cable connector
3. Graphics-card fan cable connector
4. Battery-cable connector
5. Keyboard-controller board cable connector
6. Solid state drive slot 1 (SSD-1)

- 7. Solid state drive slot 2 (SSD-2)
- 8. Left tron-light cable connector
- 9. Speaker-cable connector
- 10. WLAN card
- 11. Processor-fan cable connector
- 12. Headset-port connector
- 13. Power-button cable connector
- 14. Left-fan cable connector
- 15. I/O-board cable connector
- 16. Micro-SD-card reader cable connector
- 17. Display-cable connector

The following images indicate the location of the system board and provide a visual representation of the removal procedure.

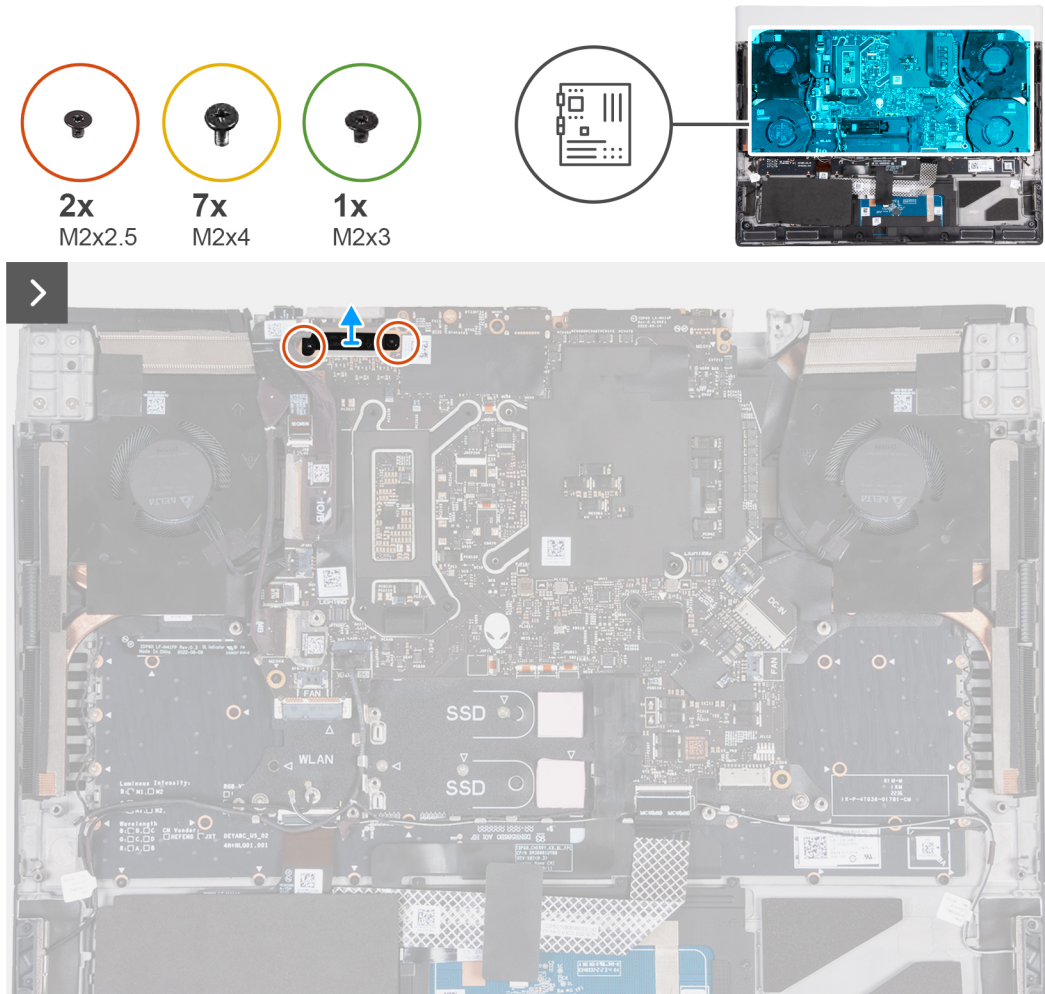

Figure 68. Removing the system board

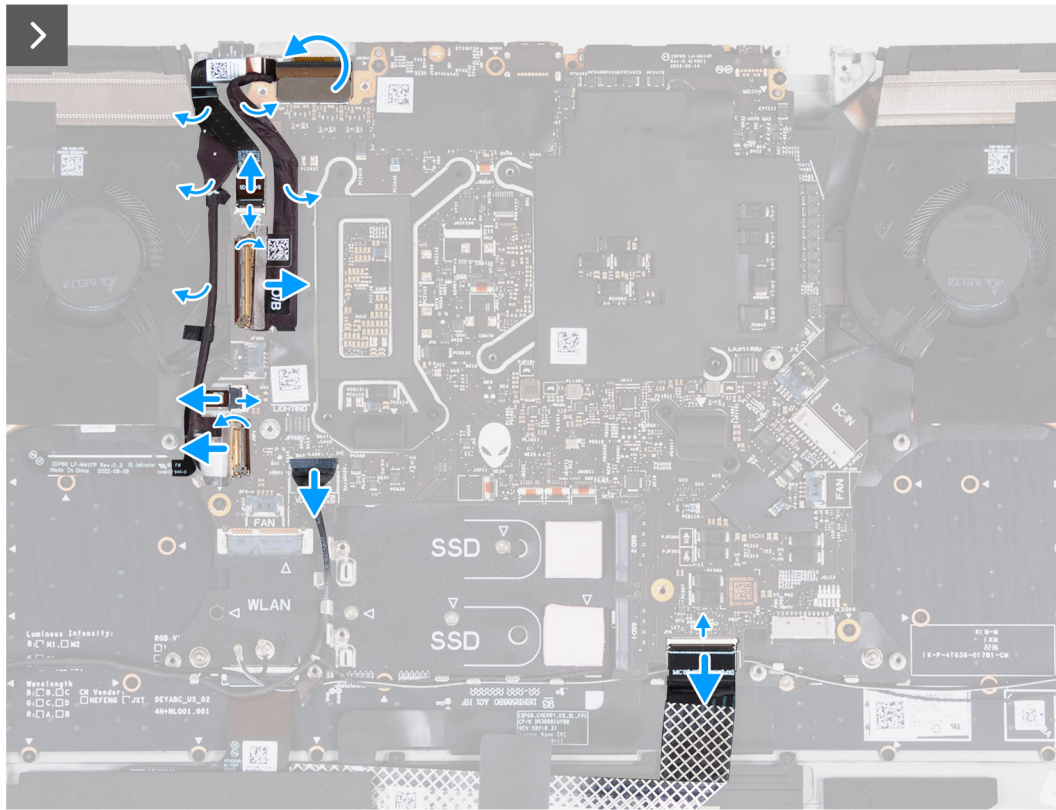

Figure 69. Removing the system board

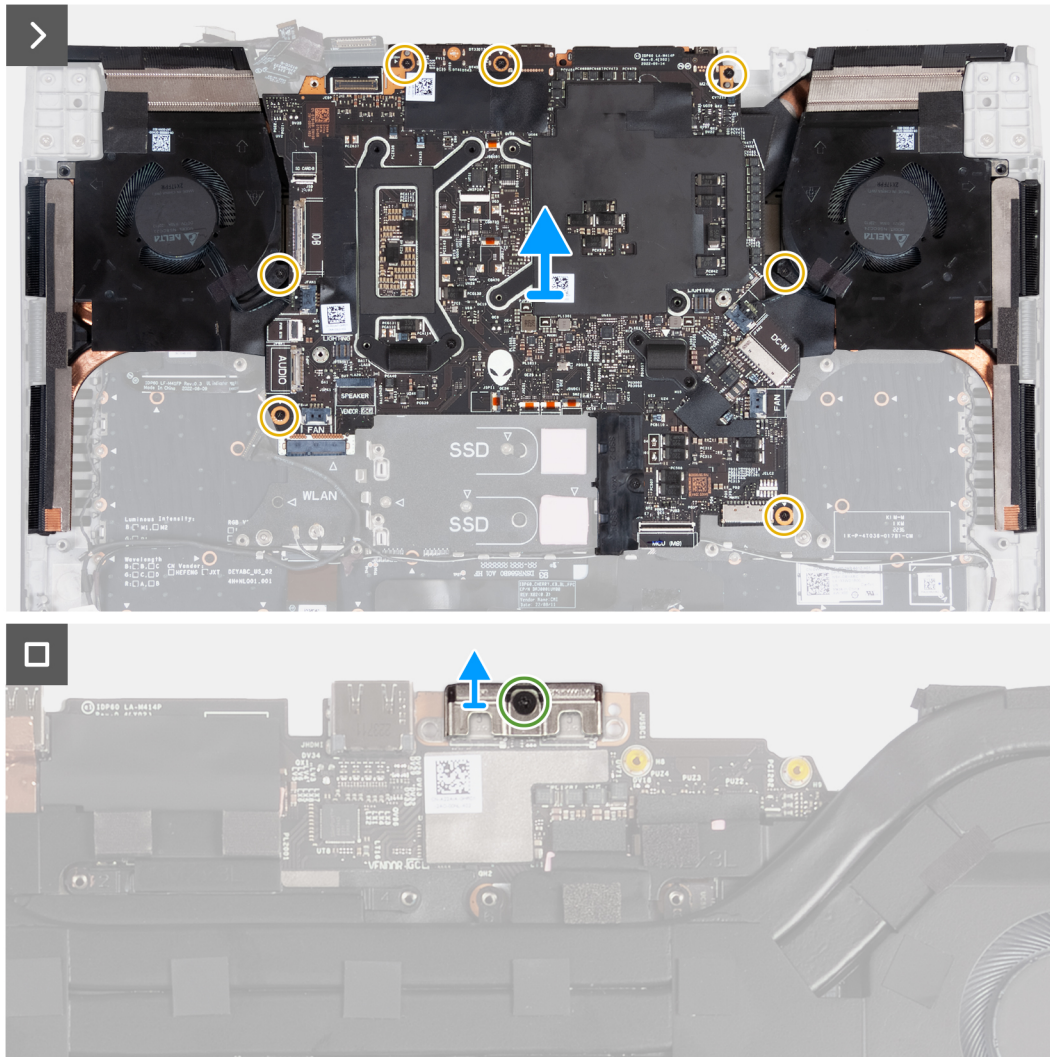

Figure 70. Removing the system board

Steps

1. Remove the two screws (M2x2.5) that secure the display-cable bracket to the system board and palm-rest and keyboard assembly.
2. Remove the display-cable bracket off the system board and palm-rest and keyboard assembly.
3. Open the latch and disconnect the microSD-card reader cable from the system board.
4. Peel the tape that secures the I/O-board cable to the system board.
5. Open the latch and disconnect the I/O-board cable from the system board.
6. Disconnect the left-fan cable from the system board.
7. Open the latch and disconnect the power-button cable from the system board.
8. Peel the tape that secures the headset port cable to the system board.
9. Open the latch and disconnect the headset port cable from the system board and remove it from the routing guides on the fan and heat-sink assembly.
10. Disconnect the speaker cable from the system board.
11. Open the latch and disconnect the keyboard-controller board cable from the system board.
12. Remove the power-adaptor port cable from the palm-rest and keyboard assembly and peel the power-adaptor port cable off the fan and heat-sink assembly.
13. Disconnect the right-fan cable from the system board.
14. Remove the seven screws (M2x4) that secure the system-board assembly to the palm-rest and keyboard assembly.
15. Grab the system-board assembly from the upper left and right side of the heat sink and lift the system-board assembly off the palm-rest and keyboard assembly.

16. Place the system-board assembly on a clean and flat surface.
17. Turn the system-board assembly over.
18. Remove the [fan and heat-sink assembly](#).
19. Remove the screw (M2x3) that secures the USB Type-C bracket to the system board.
20. Lift the USB Type-C bracket off the system board.

NOTE: The USB Type-C bracket on the bottom of the system board must be transferred to the replacement system board.

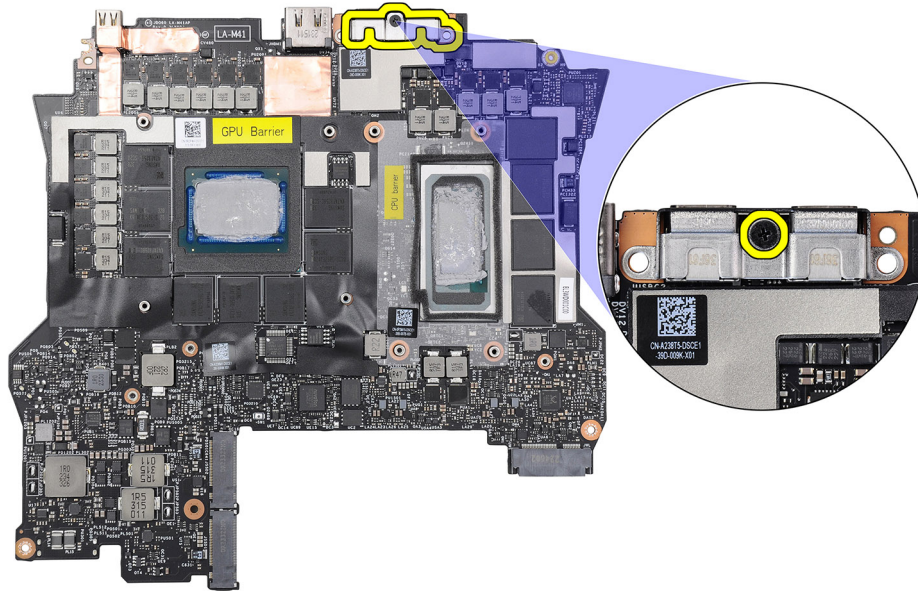

Figure 71. USB Type-C bracket

21. Turn the system-board assembly over.
22. After performing all the above steps, you are left with the system board.

NOTE: Before returning the faulty system board. Adhere the processor (CPU) sticker over the processor (CPU) chip and GPU sticker over the GPU and ensure that it covers the entire surface of it.

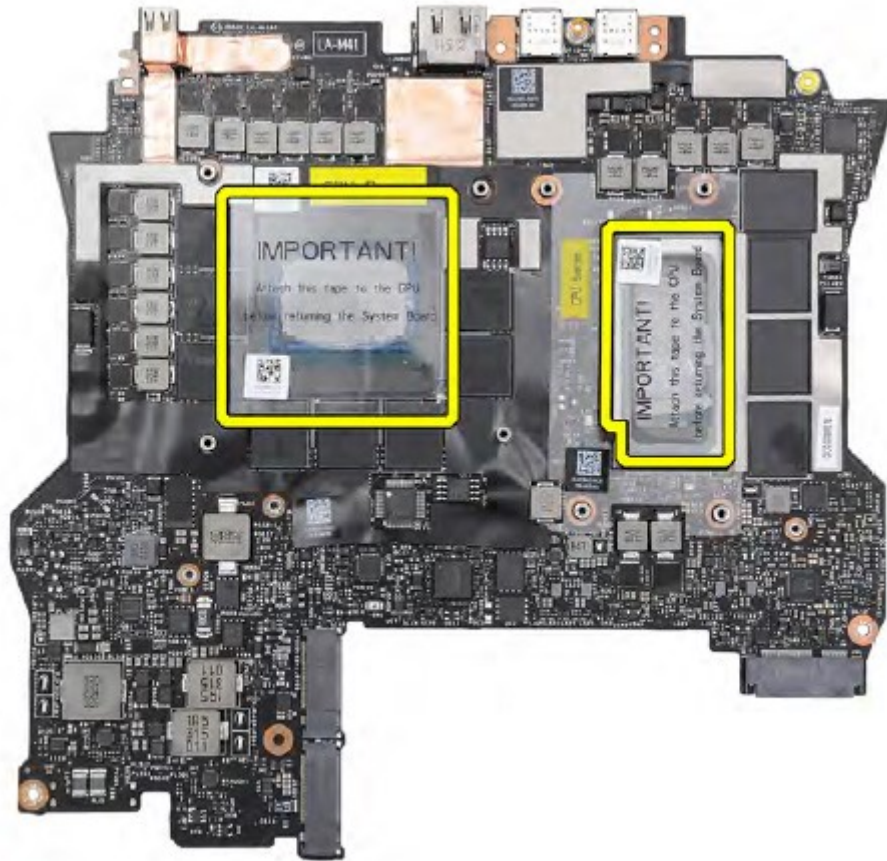

Figure 72. CPU/GPU Mylar

- ⚠ **CAUTION:** Once the system board assembly has been removed from the computer, follow the instructions in the tech sheet that is dispatched with the replacement system board assembly.
- ⚠ **CAUTION:** Do not use an alcohol wipe to clean the Element 31 thermal grease from the processor (CPU) chip which is surrounded by the processor (CPU) barrier sheet. The alcohol solution from the wipes dissolves the Element 31 grease into conductive metal particles. If these conductive metal particles come into contact with the surface of the system board, it causes an electrical short when your computer is turned on.

Installing the system board

- ⚠ **CAUTION:** The information in this installation section is intended for authorized service technicians only.

Prerequisites

If you are replacing a component, remove the existing component before performing the installation process.

About this task

- ⓘ **NOTE:** When installing this component, see the Tech Sheet that is bundled with the service kit. The presence of Element 31 grease in the computer depends on the discrete Graphics Processing Unit (GPU) configuration installed.

To determine if your computer has Element 31 grease that is applied on the CPU or GPU, see the following table.

Table 27. CPU or GPU supporting Element 31 grease

GPU	Element 31 grease
NVIDIA GeForce RTX 4060	Present in GPU only

Table 27. CPU or GPU supporting Element 31 grease (continued)

GPU	Element 31 grease
NVIDIA GeForce RTX 4070	Present in GPU only
NVIDIA GeForce RTX 4080	Present in both CPU and GPU
NVIDIA GeForce RTX 4090	Present in both CPU and GPU

NOTE: Computers that are shipped with NVIDIA GeForce RTX 4060/4070 graphics card support one M.2 2230 and one M.2 2280 solid state drive slot, whereas computers shipped with NVIDIA GeForce RTX 4080/4090 graphics card support two M.2 2280 solid state drive slots.

The following image indicates the connectors on your system board.

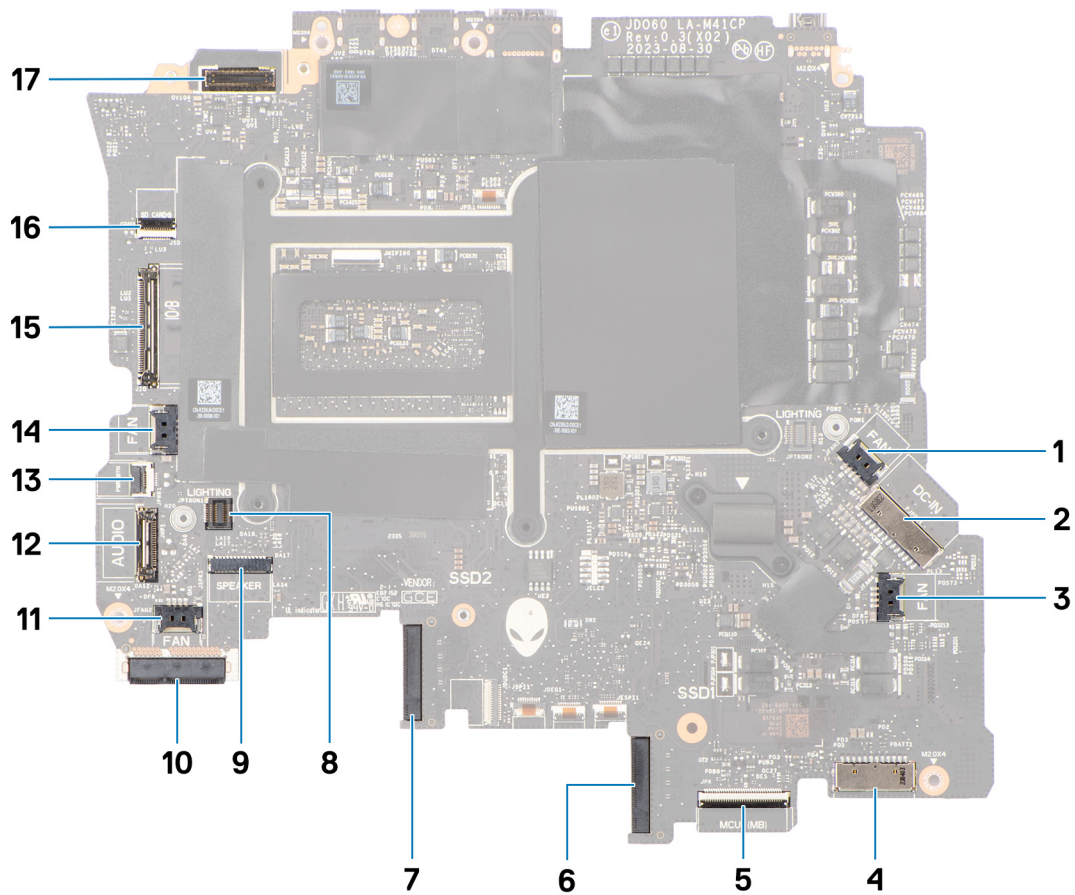

Figure 73. System board callout

1. Right-fan cable connector
2. Power-adapter port cable connector
3. Graphics-card fan cable connector
4. Battery-cable connector
5. Keyboard-controller board cable connector
6. Solid state drive slot 1 (SSD-1)
7. Solid state drive slot 2 (SSD-2)
8. Left tron-light cable connector
9. Speaker-cable connector
10. WLAN card
11. Processor-fan cable connector

- 12. Headset-port connector
- 13. Power-button cable connector
- 14. Left-fan cable connector
- 15. I/O-board cable connector
- 16. Micro-SD-card reader cable connector
- 17. Display-cable connector

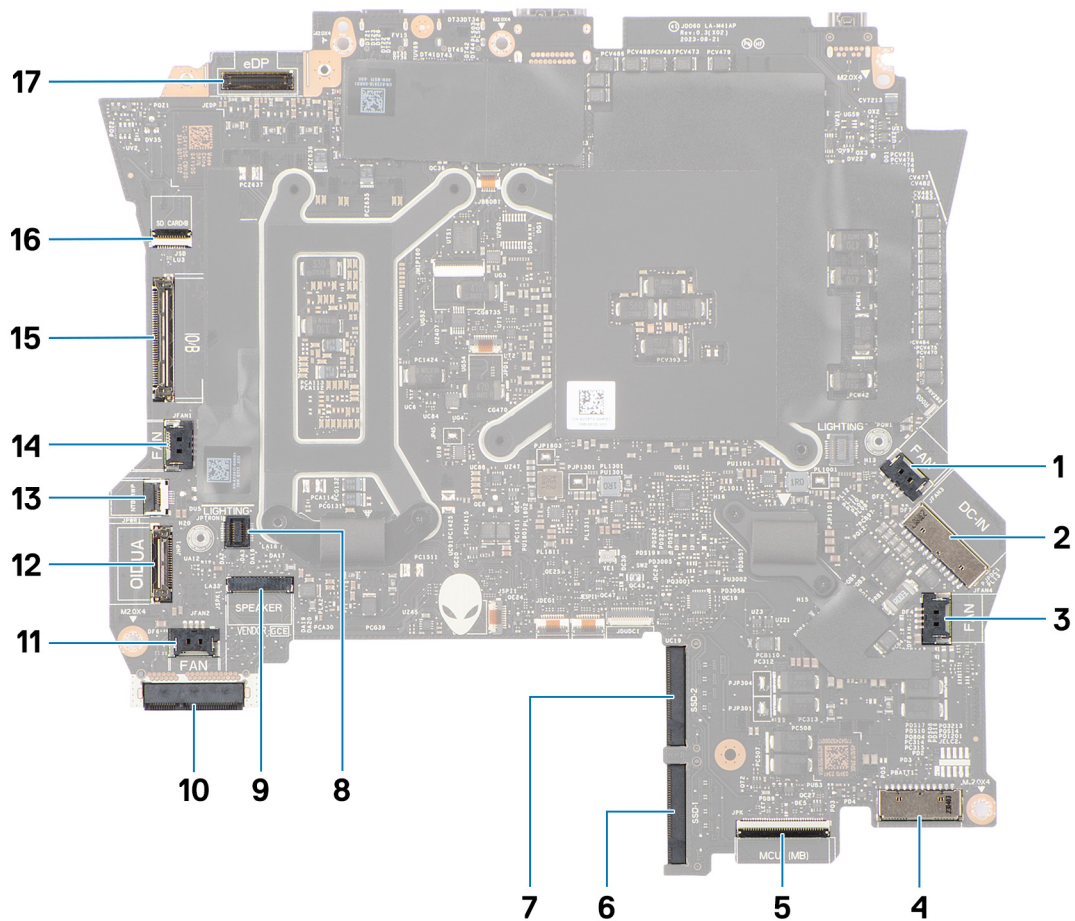

Figure 74. System board callout

- 1. Right-fan cable connector
- 2. Power-adaptor port cable connector
- 3. Graphics-card fan cable connector
- 4. Battery-cable connector
- 5. Keyboard-controller board cable connector
- 6. Solid state drive slot 1 (SSD-1)
- 7. Solid state drive slot 2 (SSD-2)
- 8. Left tron-light cable connector
- 9. Speaker-cable connector
- 10. WLAN card
- 11. Processor-fan cable connector
- 12. Headset-port connector
- 13. Power-button cable connector
- 14. Left-fan cable connector
- 15. I/O-board cable connector
- 16. Micro-SD-card reader cable connector
- 17. Display-cable connector

The following images indicate the location of the system board and provide a visual representation of the installation procedure.

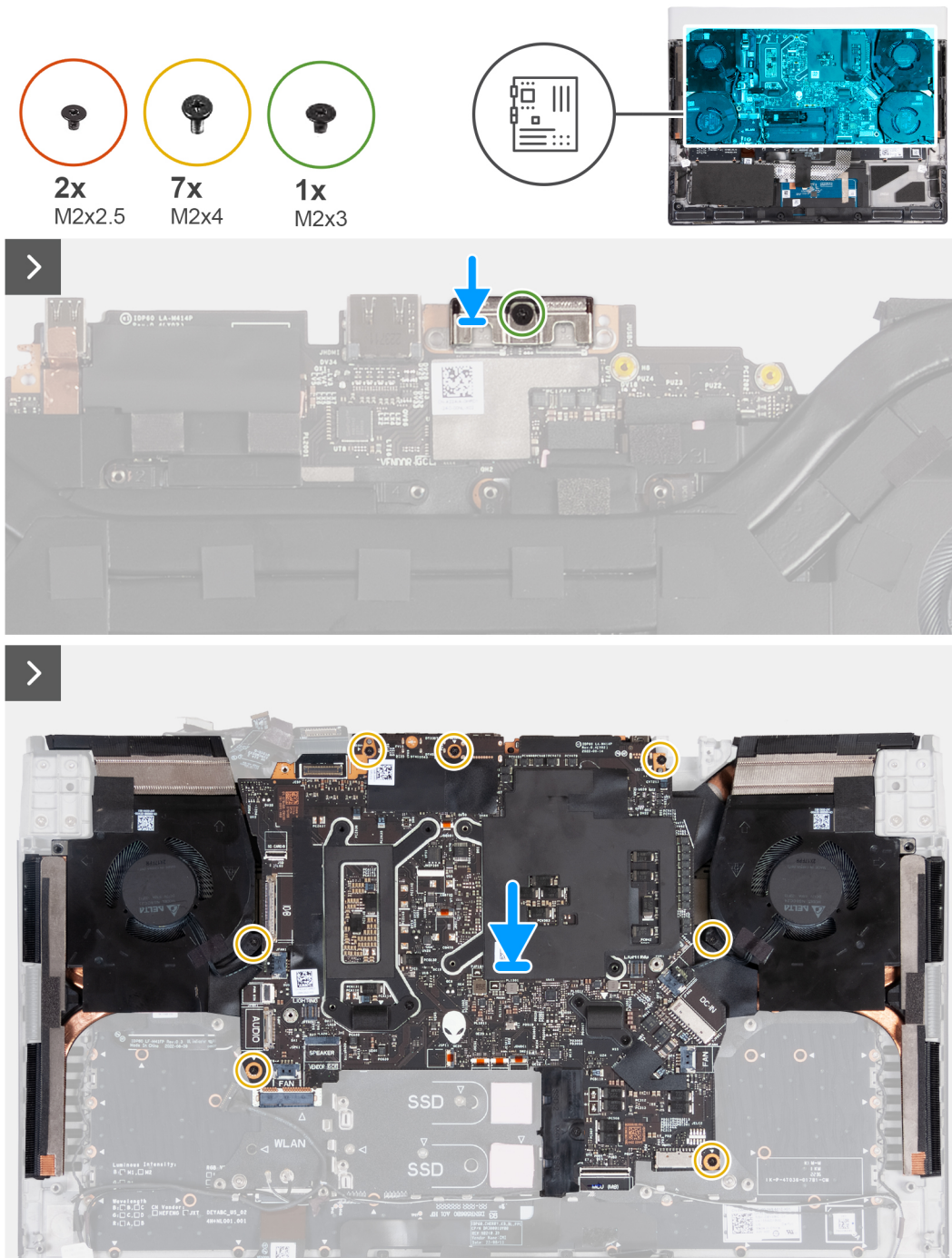

Figure 75. Installing the system board

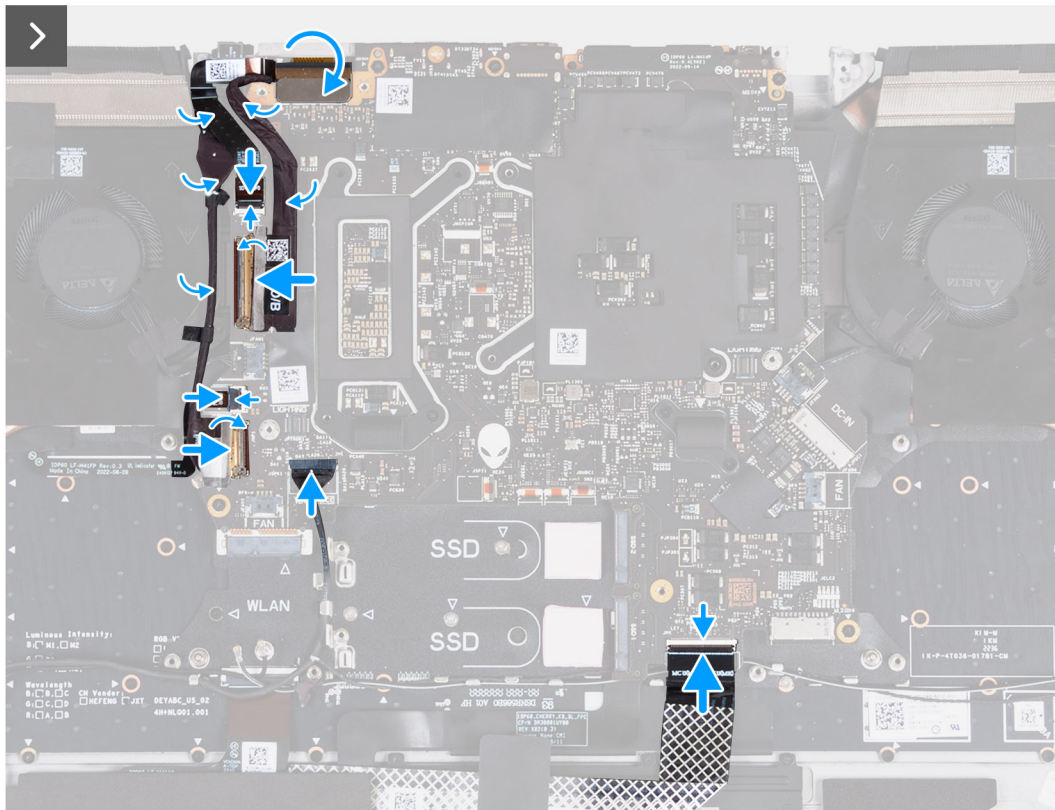

Figure 76. Installing the system board

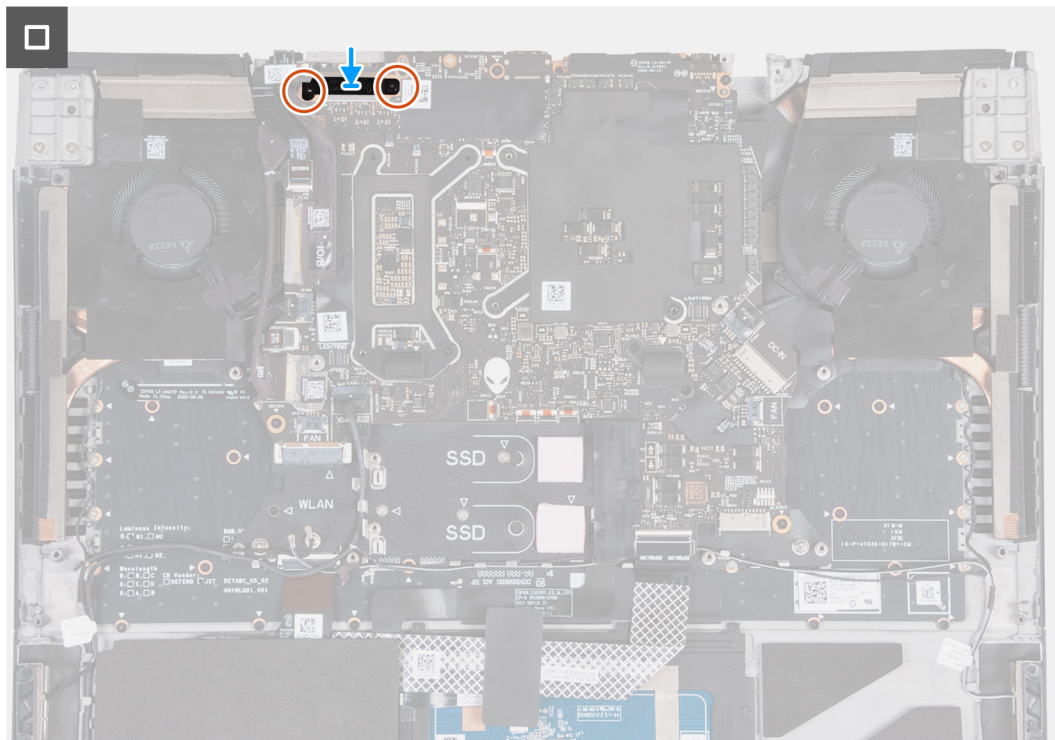

Figure 77. Installing the system board

Steps

1. Turn the system board over.
2. Align the screw hole on the USB Type-C bracket with the screw hole on the system board.

3. Replace the screw (M2x3) that secures the USB Type-C bracket to the system board.
4. Install the [fan and heat-sink assembly](#).
5. Turn the system-board assembly over and place the system-board assembly on the palm-rest and keyboard assembly.
 - ⓘ **NOTE:** When installing the system-board assembly, align the system-board assembly to the positioning pins on the palm-rest and keyboard assembly and the extensions of the heat sink to the top edge of the palm-rest and keyboard assembly.
6. Align the screw holes on the system-board assembly with the screw holes on the palm-rest and keyboard assembly.
7. Replace the seven screws (M2x4) that secure the system-board assembly to the palm-rest and keyboard assembly.
8. Slide the power-button cable into the connector on the system board and close the latch to secure the cable.
9. Slide the I/O-board cable into the connector on the system board and close the latch to secure the cable.
10. Adhere the tape that secures the I/O-board cable to the system board.
11. Connect the left-fan cable to the system board.
12. Slide the headset port cable into the connector on the system board and close the latch to secure the cable and route it through the routing guides on the fan and heat-sink assembly.
13. Adhere the tape that secures the headset port cable to the system board.
14. Slide the keyboard-controller board cable into the connector on the system board and close the latch to secure the cable.
15. Connect the headset port cable to the system board and route it through the routing guides on the fan and heat-sink assembly.
16. Connect the right fan cable to the system board.
17. Slide the microSD-card reader cable into the connector on the system board and close the latch to secure the cable.
18. Slide the display cable into the connector on the system board and close the latch to secure the cable.
19. Align the screw hole on the display-cable bracket with the screw hole on the system board.
20. Replace the two screws (M2x2.5) that secures the display-cable bracket to the system board.

Next steps

1. Install the [power-adaptor port](#).
2. Install the [rear I/O-cover](#).
3. Install the [graphics-card fan](#).
4. Install the [processor fan](#).
5. Install the [solid state drive bracket](#).
6. Install the [M.2 2230 solid state drive](#) or [M.2 2280 solid state drive](#), as applicable.
7. Install the [wireless card](#).
8. Install the [battery](#).
9. Install the [base cover](#).
10. Follow the procedure in [After working inside your computer](#).

Fan and heat-sink assembly

Removing the fan and heat-sink assembly

 **CAUTION:** The information in this removal section is intended for authorized service technicians only.

Prerequisites

1. Follow the procedure in [Before working inside your computer](#).
2. Remove the [base cover](#).
3. Remove the [battery](#).
4. Remove the [wireless card](#).
5. Remove the [M.2 2230 solid state drive](#) or [M.2 2280 solid state drive](#), as applicable.
6. Remove the [solid state drive bracket](#).
7. Remove the [processor fan](#).
8. Remove the [graphics-card fan](#).
9. Remove the [rear I/O-cover](#).

10. Follow the procedure from step 1 to step 17 in [Removing the system board](#).

About this task

NOTE: When installing this component, see the Tech Sheet that is bundled with the service kit. The presence of Element 31 grease in the computer depends on the discrete Graphics Processing Unit (GPU) configuration installed.

To determine if your computer has Element 31 grease applied on the CPU or GPU, see the following table.

Table 28. CPU or GPU supporting Element 31 grease

GPU	Element 31 grease
NVIDIA GeForce RTX 4060	Present in GPU only
NVIDIA GeForce RTX 4070	Present in GPU only
NVIDIA GeForce RTX 4080	Present in both CPU and GPU
NVIDIA GeForce RTX 4090	Present in both CPU and GPU

NOTE: The heat sink may become hot during normal operation. Allow sufficient time for the heat sink to cool before you touch it.

NOTE: For maximum cooling of the processor, do not touch the heat transfer areas on the heat sink. The oils in your skin can reduce the heat transfer capability of the thermal grease.

The following images indicate the location of the fan and heat-sink assembly and provide a visual representation of the removal procedure.



6x
M2x3

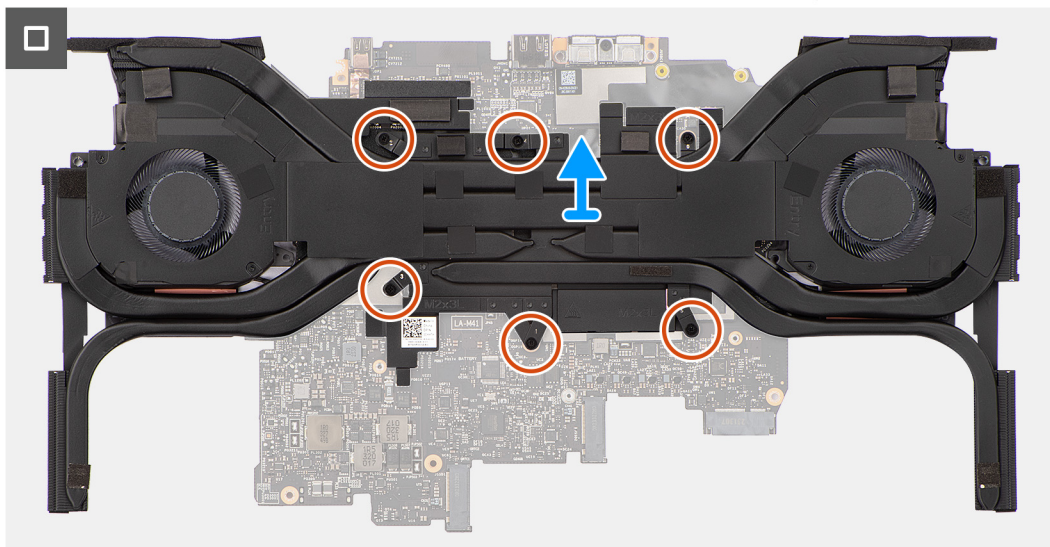
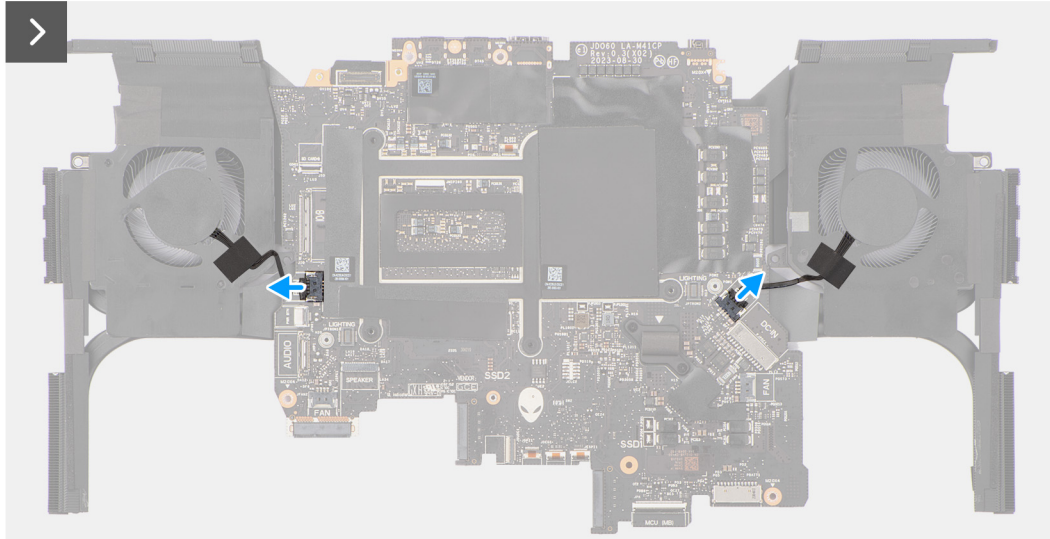
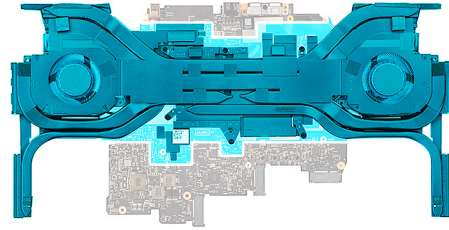

Figure 78. Removing the fan and heat-sink assembly

Steps

1. Disconnect the left and right fan cables from the system board.
2. Turn the system-board assembly over.
3. In the reverse sequential order (6>5>4>3>2>1), remove the six screws (M2x3) that secure the fan and heat-sink assembly to the system board.
4. Lift the fan and heat-sink assembly off the system board.

CAUTION: Do not use an alcohol wipe to clean the Element 31 thermal grease off the surface of the CPU or GPU, the alcohol solution from the wipes dissolve the Element 31 grease into conductive metal particles. If these conductive metal particles come into contact with the surface of the system board, it causes an electrical short when your computer is turned on.

Installing the fan and heat-sink assembly

CAUTION: The information in this installation section is intended for authorized service technicians only.

Prerequisites

If you are replacing a component, remove the existing component before performing the installation process.

About this task

NOTE: When installing this component, see the Tech Sheet that is bundled with the service kit. The presence of Element 31 grease in the computer depends on the discrete Graphics Processing Unit (GPU) configuration installed.

To determine if your computer has Element 31 grease applied on the CPU or GPU, see the following table.

Table 29. Service kit items

GPU	Element 31 grease
NVIDIA GeForce RTX 4060	Present in GPU only
NVIDIA GeForce RTX 4070	Present in GPU only
NVIDIA GeForce RTX 4080	Present in both CPU and GPU
NVIDIA GeForce RTX 4090	Present in both CPU and GPU

NOTE: Thermal grease is already pre-applied to the new thermal assembly. DO NOT apply additional thermal grease.

The following images indicate the location of the fan and heat-sink assembly and provide a visual representation of the installation procedure.

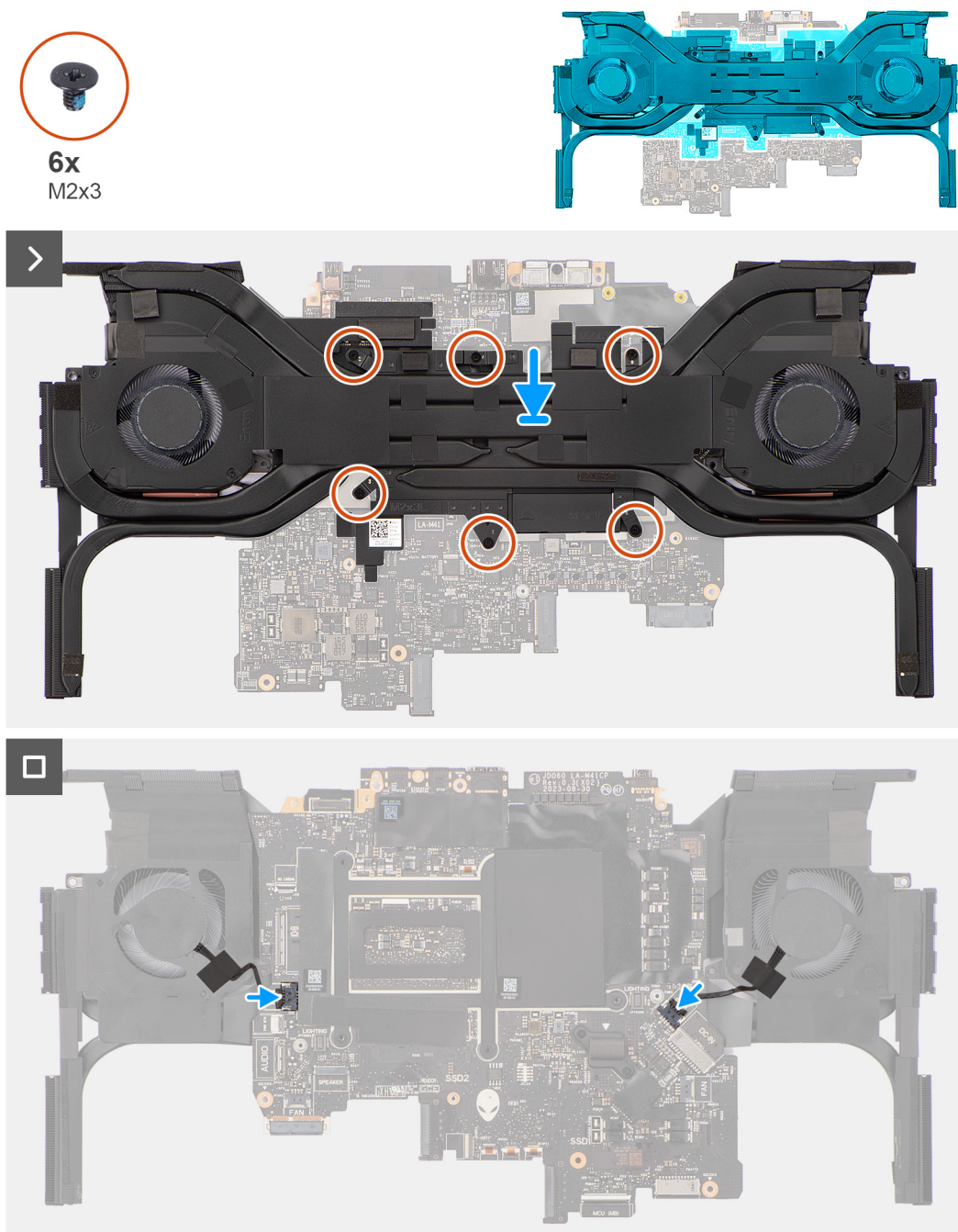

Figure 79. Installing the fan and heat-sink assembly

Steps

1. **CAUTION:** Do not use an alcohol wipe to clean the Element 31 thermal grease off the surface of the CPU or GPU, the alcohol solution from the wipes dissolve the Element 31 grease into conductive metal particles. If these conductive metal particles come into contact with the surface of the system board, it causes an electrical short when your computer is turned on.

Align and place the fan and heat-sink assembly on the system board.

2. Align the screw holes on the fan and heat-sink assembly to the screw holes on the system board.
3. In the sequential order (1>2>3>4>5>6), replace the six screws (M2x3) that secure the fan and heat-sink assembly to the system board.
4. Turn the system-board assembly over.

5. Connect the left fan and right fan cables to the system board.

Next steps

1. Follow the procedure from step 5 to step 20 in [Replacing the system board](#).

 **NOTE:** The system board can be removed and installed along with the heat sink. This simplifies the removal and installation procedure and avoids breaking the thermal bond between the system board and heat sink.

2. Install the [rear I/O-cover](#).
3. Install the [graphics-card fan](#).
4. Install the [processor fan](#).
5. Install the [solid state drive bracket](#).
6. Install the [M.2 2230 solid state drive](#) or [M.2 2280 solid state drive](#), as applicable.
7. Install the [wireless card](#).
8. Install the [battery](#).
9. Install the [base cover](#).
10. Follow the procedure in [After working inside your computer](#).

WLAN board

Removing the I/O board

 **CAUTION:** The information in this removal section is intended for authorized service technicians only.

Prerequisites

1. Remove the [base cover](#).
2. Remove the [battery](#).
3. Remove the [wireless card](#).
4. Remove the [M.2 2230 solid state drive](#) or [M.2 2280 solid state drive](#), as applicable.
5. Remove the [solid state drive bracket](#).
6. Remove the [processor fan](#).
7. Remove the [graphics-card fan](#).
8. Remove the [rear I/O-cover](#).
9. Remove the [display assembly](#).
10. Follow the procedure from step 1 to step 16 in [Removing the system board](#).

 **NOTE:** The system board can be removed and installed along with the heat sink. This simplifies the removal and installation procedure and avoids breaking the thermal bond between the system board and heat sink.

About this task

The following images indicate the location of the I/O board and provide a visual representation of the removal procedure.

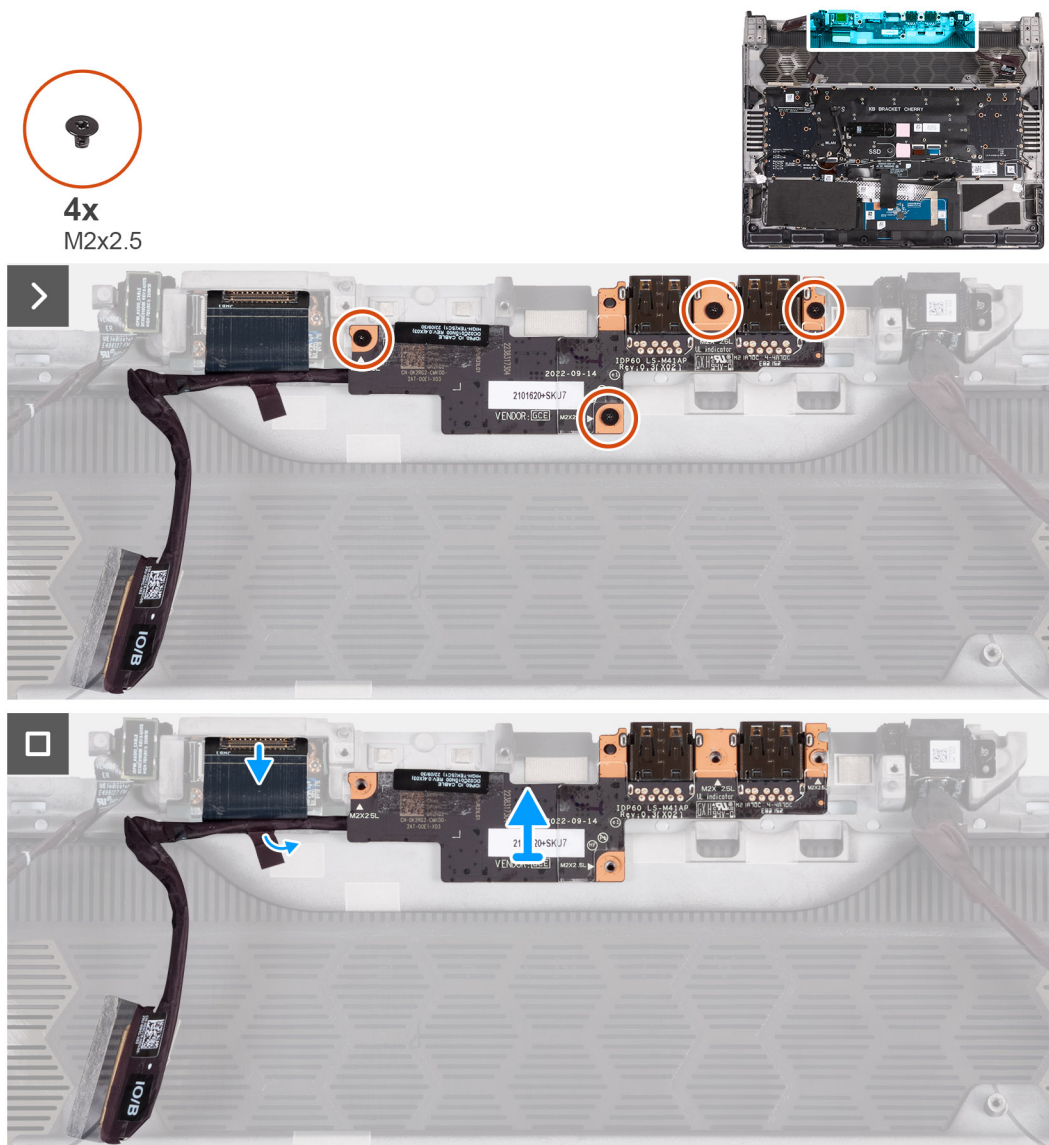

Figure 80. Removing the I/O board

Steps

1. Remove the four screws (M2x2.5) that secure the I/O board to the palm-rest and keyboard assembly.
2. Remove the tape that secures the I/O daughter board cable to the palm-rest and keyboard assembly.
3. Disconnect and remove the I/O daughter board cable from the I/O daughter board.
4. Lift the I/O board off the palm-rest and keyboard assembly.

Installing the I/O board

⚠ CAUTION: The information in this installation section is intended for authorized service technicians only.

Prerequisites

If you are replacing a component, remove the existing component before performing the installation process.

About this task

The following images indicate the location of the I/O board and provide a visual representation of the installation procedure.

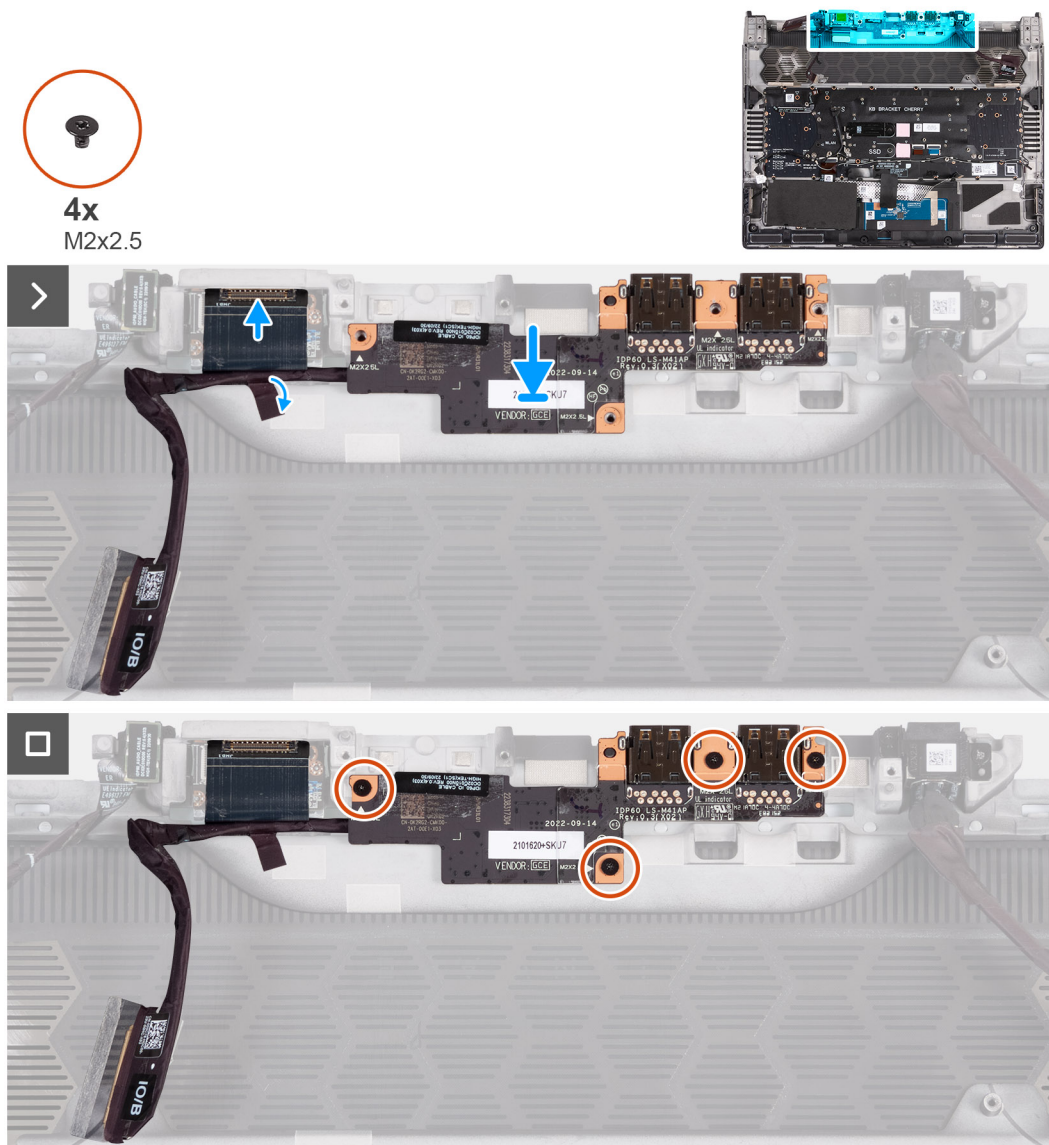

Figure 81. Installing the I/O board

Steps

1. Align the screw holes on the I/O board with the screw holes on the palm-rest and keyboard assembly.
2. Replace the four screws (M2x2.5) that secure the I/O board to the palm-rest and keyboard assembly.
3. Connect and remove the I/O daughter board cable from the I/O daughter board.
4. Adhere the tape that secures the I/O daughter board cable to the palm-rest and keyboard assembly.

Next steps

1. Follow the procedure from step 5 to step 20 in [Replacing the system board](#).

NOTE: The system board can be removed and installed along with the heat sink. This simplifies the removal and installation procedure and avoids breaking the thermal bond between the system board and heat sink.

2. Install the [display assembly](#).
3. Install the [rear I/O-cover](#).
4. Install the [graphics-card fan](#).
5. Install the [processor fan](#).
6. Install the [solid state drive bracket](#).
7. Install the [M.2 2230 solid state drive](#) or [M.2 2280 solid state drive](#), as applicable.

8. Install the [wireless card](#).
9. Install the [battery](#).
10. Install the [base cover](#).
11. Follow the procedure in [After working inside your computer](#).

Power button

Removing the power button

 **CAUTION:** The information in this removal section is intended for authorized service technicians only.

Prerequisites

1. Follow the procedure in [Before working inside your computer](#).
2. Remove the [base cover](#).
3. Remove the [battery](#).
4. Remove the [wireless card](#).
5. Remove the [M.2 2230 solid state drive](#) or [M.2 2280 solid state drive](#), as applicable.
6. Remove the [solid state drive bracket](#).
7. Remove the [rear I/O-cover](#).
8. Remove the [processor fan](#).
9. Remove the [graphics-card fan](#).
10. Remove the [power-adaptor port](#).
11. Follow the procedure from step 1 to step 16 in [Removing the system board](#).

 **NOTE:** The system board can be removed and installed along with the heat sink. This simplifies the removal and installation procedure and avoids breaking the thermal bond between the system board and heat sink.

About this task

The following images indicate the location of the power button and provide a visual representation of the removal procedure.

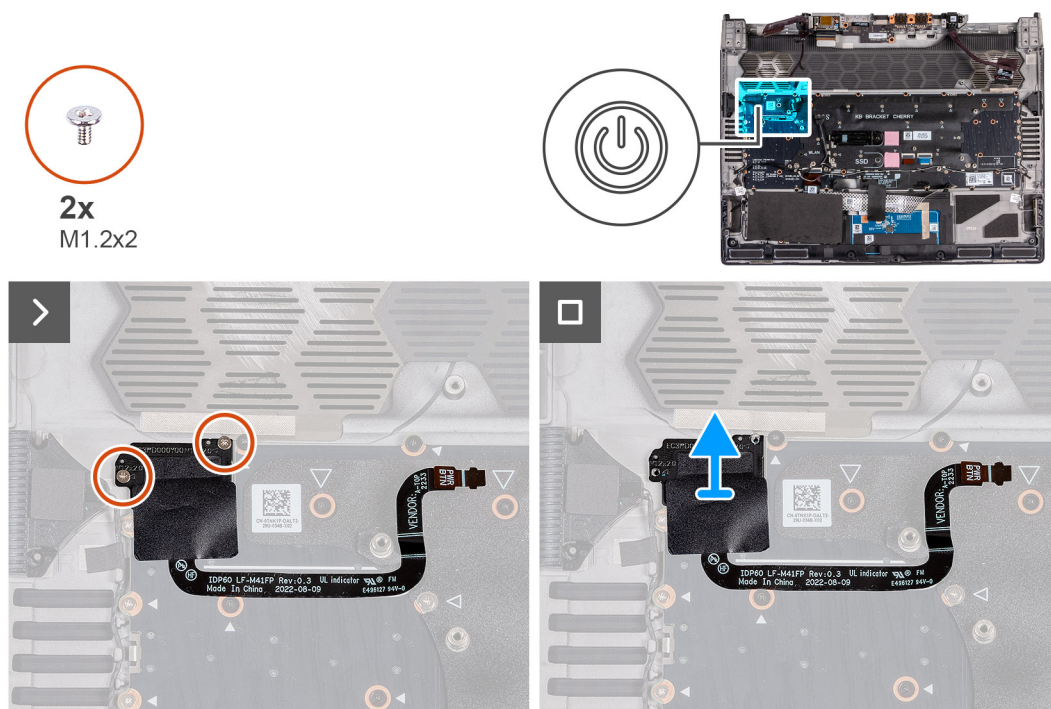

Figure 82. Removing the power button

Steps

1. Remove the two (M1.2x2) screws that secure the power button to the palm-rest and keyboard assembly.
2. Lift the power button, along with its cable, off the palm-rest and keyboard assembly.

Installing the power button

 **CAUTION:** The information in this installation section is intended for authorized service technicians only.

Prerequisites

If you are replacing a component, remove the existing component before performing the installation process.

About this task

The following images indicate the location of the power button and provide a visual representation of the installation procedure.

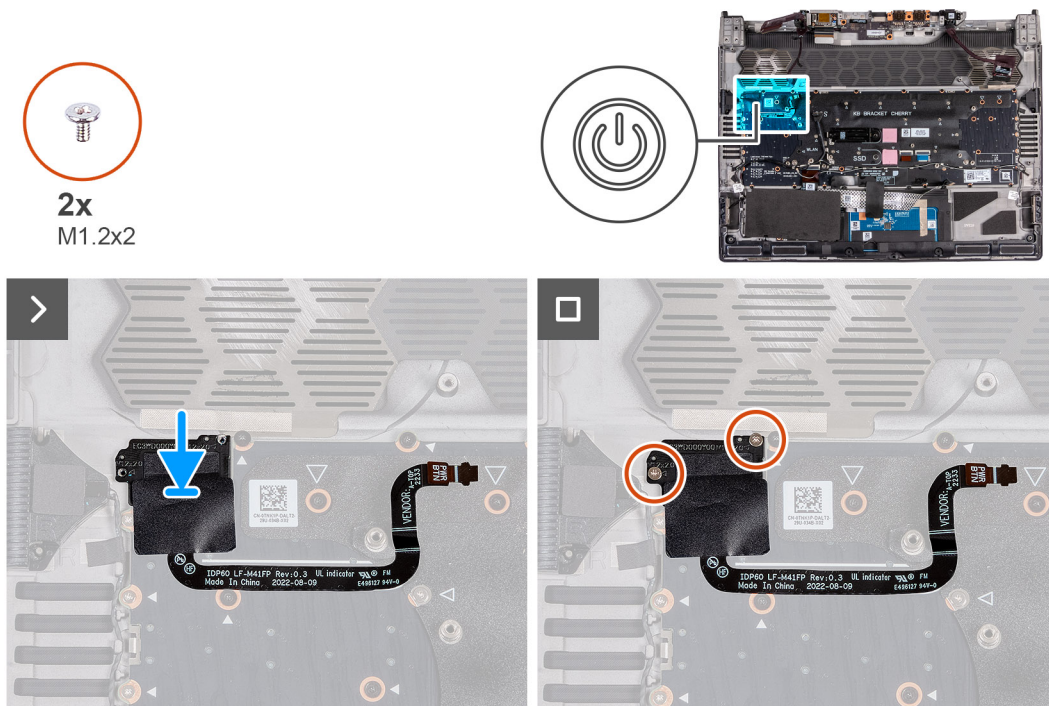



Figure 83. Installing the power button

Steps

1. Align and place the power button, along with its cable, into the slot on the palm-rest and keyboard assembly.
2. Replace the two screws (M1.2x2) that secure the power button to the palm-rest and keyboard assembly.

Next steps

1. Follow the procedure from step 5 to step 20 in [Replacing the system board](#).

 **NOTE:** The system board can be removed and installed along with the heat sink. This simplifies the removal and installation procedure and avoids breaking the thermal bond between the system board and heat sink.

2. Install the [power-adapter port](#).
3. Install the [rear I/O-cover](#).
4. Install the [graphics-card fan](#).
5. Install the [processor fan](#).
6. Install the [solid state drive bracket](#).
7. Install the [M.2 2230 solid state drive](#) or [M.2 2280 solid state drive](#), as applicable.

8. Install the [wireless card](#).
9. Install the [battery](#).
10. Install the [base cover](#).
11. Follow the procedure in [After working inside your computer](#).

Palm-rest and keyboard assembly

Removing the palm-rest and keyboard assembly

 **CAUTION:** The information in this removal section is intended for authorized service technicians only.

Prerequisites

1. Follow the procedure in [Before working inside your computer](#).
2. Remove the [base cover](#).
3. Remove the [battery](#).
4. Remove the [wireless card](#).
5. Remove the [M.2 2230 solid state drive](#) or [M.2 2280 solid state drive](#), as applicable.
6. Remove the [solid state drive bracket](#).
7. Remove the [processor fan](#).
8. Remove the [graphics-card fan](#).
9. Remove the [rear I/O-cover](#).
10. Remove the [power-adapter port](#).
11. Remove the [headset port](#).
12. Remove the [display assembly](#).
13. Remove the [touchpad](#).
14. Remove the [keyboard-controller board](#).
15. Follow the procedure from step 1 to step 16 in [Removing the system board](#).

 **NOTE:** The system board can be removed and installed along with the heat sink. This simplifies the removal and installation procedure and avoids breaking the thermal bond between the system board and heat sink.

16. Remove the [I/O board](#).
17. Remove the [power button](#).

Steps

After performing the pre-requisites, you are left with the palm-rest and keyboard assembly.

 **NOTE:** The left and right tweeters are adhered to the palm-rest and keyboard assembly with strong adhesive and should not be removed. The replacement palm-rest and keyboard assembly will be shipped with the speakers. Install the speakers and tweeters to the new palm-rest and keyboard assembly. For installing the speakers and tweeters, see step 1 to step 5 in [Installing the palm-rest and keyboard assembly](#).

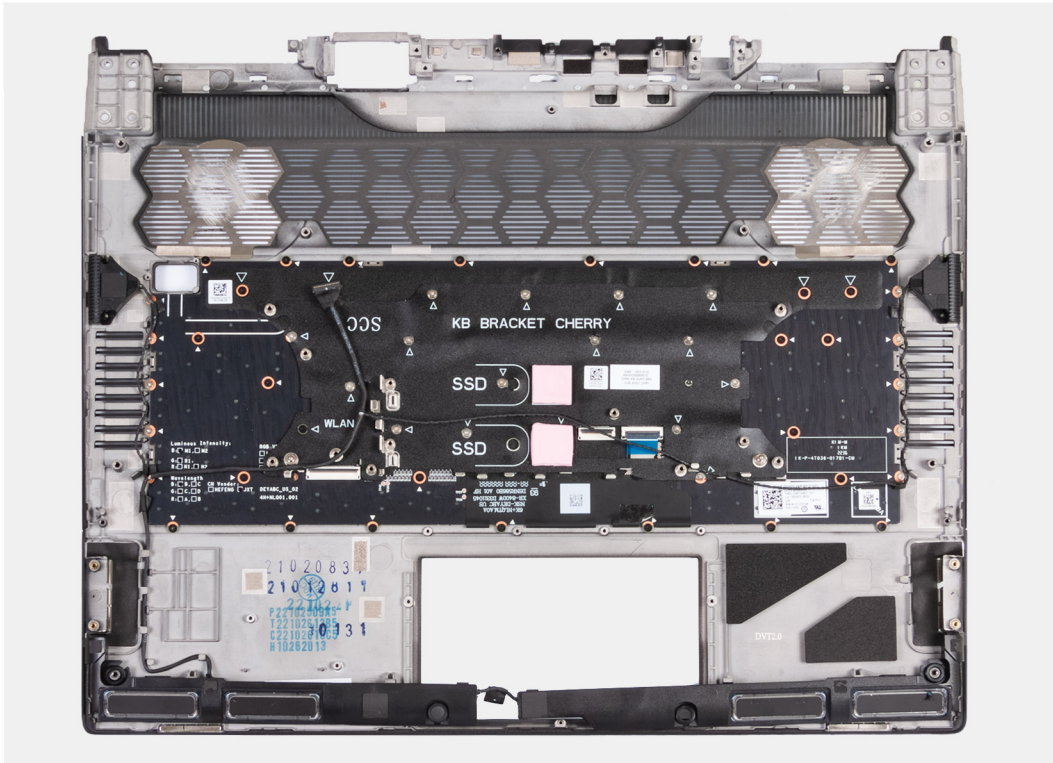

Figure 84. Removing the palm-rest and keyboard assembly

NOTE: When replacing the palm-rest and keyboard assembly for computers with a M.2 2230 solid state drive installed, ensure that the M.2 2230 solid state drive mounting bracket has been removed from the palm-rest and keyboard assembly and installed on the new palm-rest and keyboard assembly.

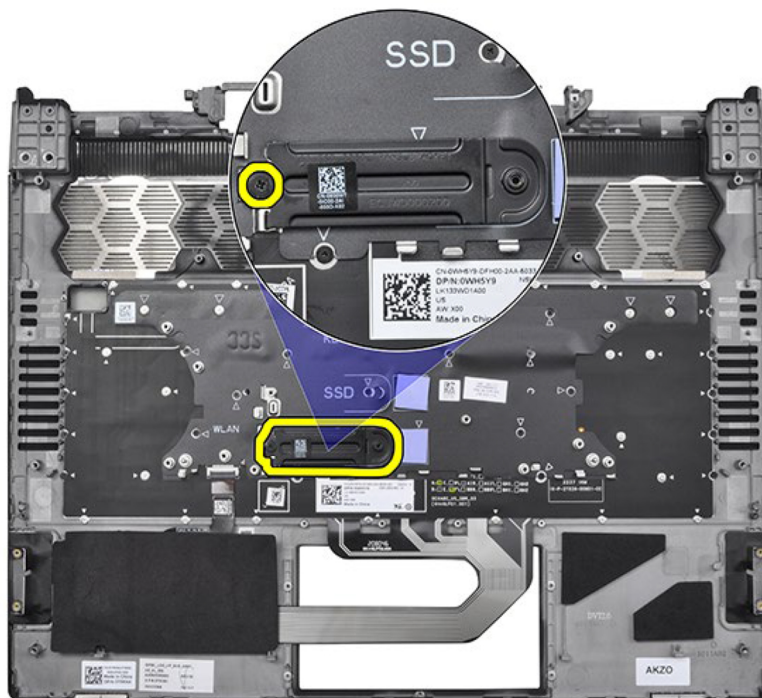

Figure 85. Removing the palm-rest and keyboard assembly

Installing the palm-rest and keyboard assembly

CAUTION: The information in this installation section is intended for authorized service technicians only.

Prerequisites

If you are replacing a component, remove the existing component before performing the installation process.

About this task

NOTE: When replacing the palm-rest and keyboard assembly for computers with a M.2 2230 solid state drive installed, ensure that the M.2 2230 solid state drive mounting bracket has been removed from the palm-rest and keyboard assembly and installed on the new palm-rest and keyboard assembly.

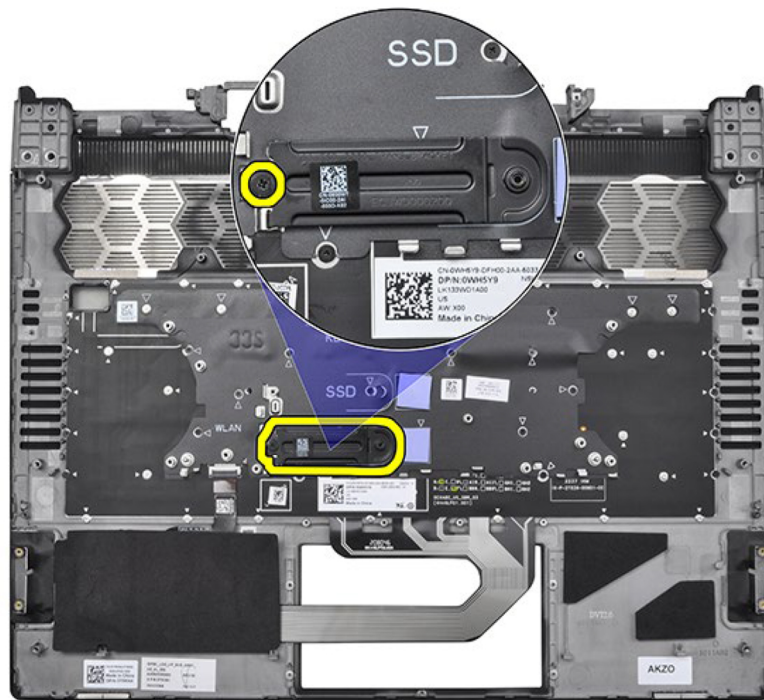

Figure 86. Installing the palm-rest and keyboard assembly

NOTE: The replacement palm-rest and keyboard assembly are shipped with the speakers which are not preassembled to the palm-rest and keyboard assembly. Before performing the prerequisites, follow step 1 to step 5 to install the speakers and tweeters to the new palm-rest and keyboard assembly.

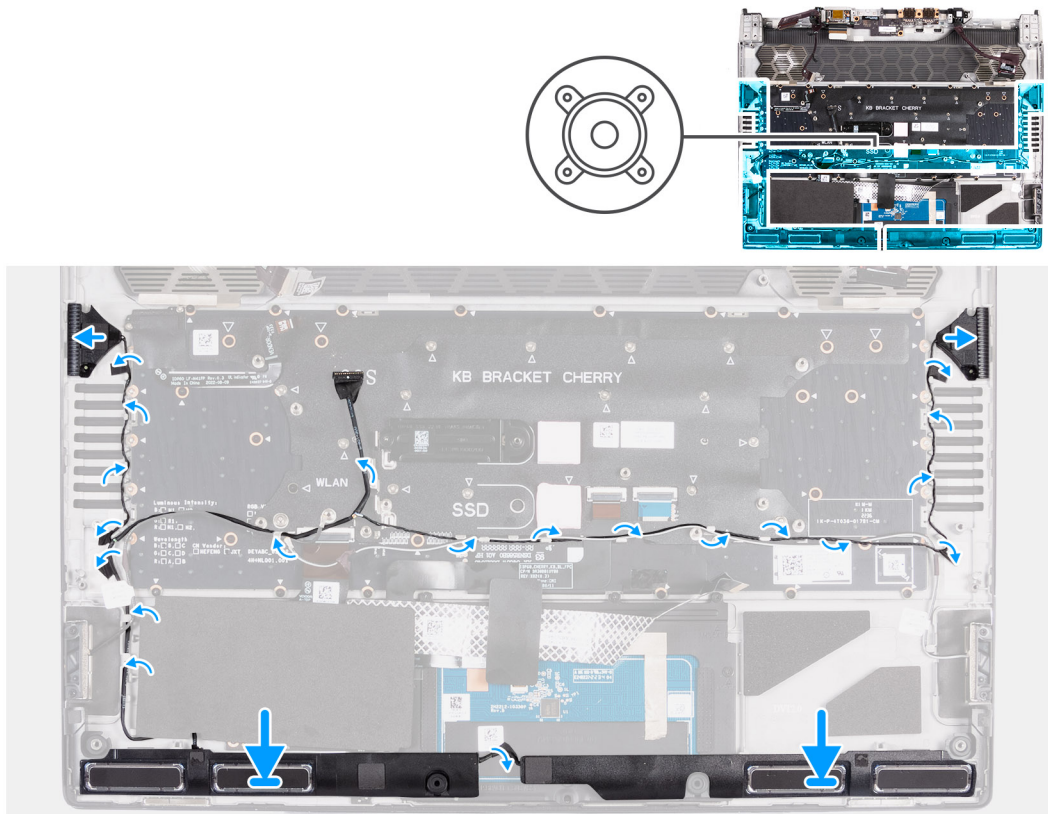

Figure 87. Installing speaker and tweeters

Steps

1. Using the alignment posts, place the left and right speakers into their slots on the palm-rest and keyboard assembly.
2. Peel off the protective film to expose the adhesive on the back of the tweeters.
3. Align and install the left and right tweeters into their slots on the palm-rest and keyboard assembly as shown in the image.
4. Route the speaker cable through the routing guides on the palm-rest and keyboard assembly as shown in the image.
5. Adhere the tape that secures the speaker cable to the palm-rest and keyboard assembly.
6. After installing the speakers, go to perform the prerequisites.

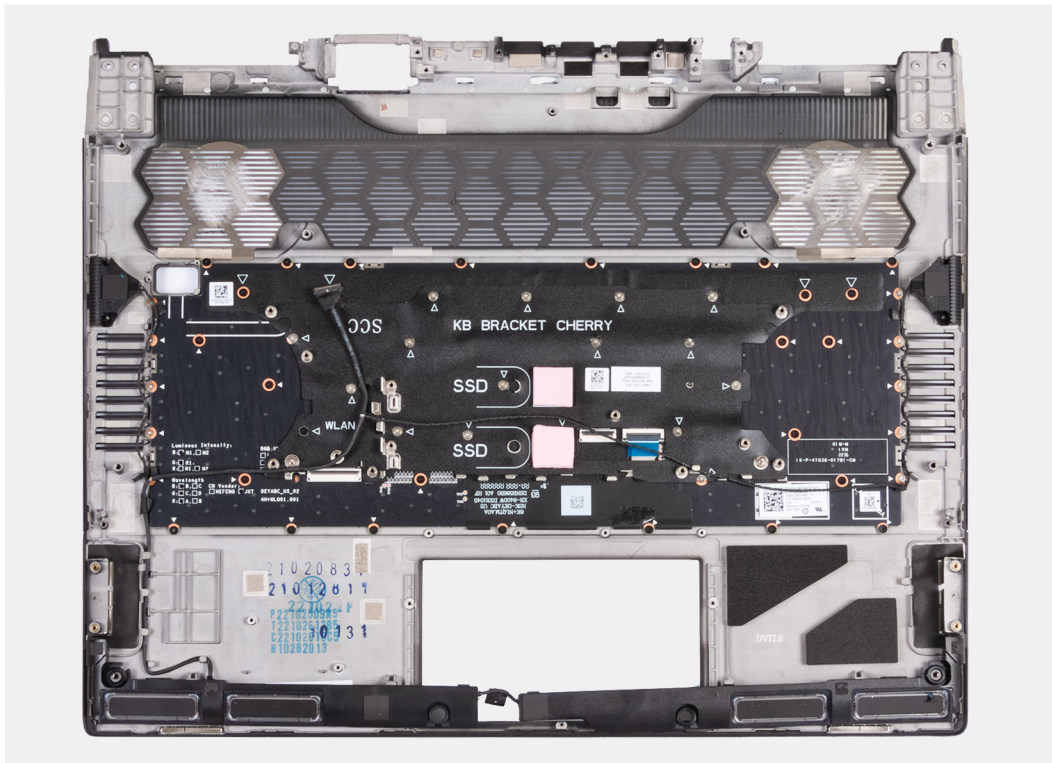

Figure 88. Installing the palm-rest and keyboard assembly

Next steps

1. Install the [power button](#).
2. Install the [I/O board](#).
3. Follow the procedure from step 5 to step 20 in [Replacing the system board](#).

NOTE: The system board can be removed and installed along with the heat sink. This simplifies the removal and installation procedure and avoids breaking the thermal bond between the system board and heat sink.

4. Install the [keyboard-controller board](#).
5. Install the [touchpad](#).
6. Install the [display assembly](#).
7. Install the [headset port](#).
8. Install the [power-adaptor port](#).
9. Install the [rear I/O-cover](#).
10. Install the [graphics-card fan](#).
11. Install the [processor fan](#).
12. Install the [solid state drive bracket](#).
13. Install the [M.2 2230 solid state drive](#) or [M.2 2280 solid state drive](#), as applicable.
14. Install the [wireless card](#).
15. Install the [battery](#).
16. Install the [base cover](#).
17. Follow the procedure in [After working inside your computer](#).

BIOS Setup

NOTE: Depending on the computer and the installed devices, the options that are listed in this section may or may not be displayed.

CAUTION: Certain changes can make your computer work incorrectly. Before you change the settings in BIOS Setup, it is recommended that you note down the original settings for future reference.

Use BIOS Setup for the following purposes:

- Get information about the hardware installed in your computer, such as the amount of RAM and the capacity of the storage device.
- Change the system configuration information.
- Set or change a user-selectable option, such as the user password, type of storage device installed, and enable or disable base devices.

Entering BIOS Setup program

About this task

Turn on (or restart) your computer and press F2 immediately.

Navigation keys

NOTE: For most of the BIOS Setup options, changes that you make are recorded but do not take effect until you restart the computer.

Table 30. Navigation keys

Keys	Navigation
Up arrow	Moves to the previous field.
Down arrow	Moves to the next field.
Enter	Selects a value in the selected field (if applicable) or follows the link in the field.
Spacebar	Expands or collapses a drop-down list, if applicable.
Tab	Moves to the next focus area.
Esc	Moves to the previous page until you view the main screen. Pressing Esc in the main screen displays a message that prompts you to save any unsaved changes and restart the computer.

F12 One Time Boot menu

To enter the One Time Boot menu, turn on or restart your computer, and then press F12 immediately.

NOTE: If you are unable to enter the One Time Boot menu, repeat the above action.

The One Time Boot menu displays the devices that you can boot from and also display the options to start diagnostics. The boot menu options are:

- Removable Drive (if available)
- STXXX Drive (if available)

NOTE: XXX denotes the SATA drive number.

- Optical Drive (if available)
- SATA Hard Drive (if available)
- Diagnostics

The One Time Boot menu screen also displays the option to access BIOS Setup.

System setup options

NOTE: Depending on your computer and its installed devices, the items that are listed in this section may or may not be displayed.

Table 31. System setup options—Overview menu

Overview	
Alienware x16 R2	
BIOS Version	Displays the BIOS version number.
Service Tag	Displays the Service Tag of the computer.
Asset Tag	Displays the Asset Tag of the computer.
Manufacture Date	Displays the manufacture date of the computer.
Ownership Date	Displays the ownership date of the computer.
Express Service Code	Displays the Express Service Code of the computer.
Ownership Tag	Displays the Ownership Tag of the computer.
Signed Firmware Update	Displays whether the Signed Firmware Update is enabled on your computer. By default, the Signed Firmware Update option is enabled.
Battery Information	
Primary	Displays the primary battery of the computer.
Battery Level	Displays the battery level of the computer.
Battery State	Displays the battery state of the computer.
Health	Displays the battery health of the computer.
AC Adapter	Displays whether an AC adapter is connected. If connected, displays the type of AC adapter that is connected.
Processor Information	
Processor Type	Displays the processor type.
Maximum Clock Speed	Displays the maximum processor clock speed.
Minimum Clock Speed	Displays the minimum processor clock speed.
Current Clock Speed	Displays the current processor clock speed.
Core Count	Displays the number of cores on the processor.
Processor ID	Displays the processor identification code.
Processor L2 Cache	Displays the processor L2 Cache size.
Processor L3 Cache	Displays the processor L3 Cache size.
Microcode Version	Displays the microcode version.
Intel Hyper-Threading Capable	Displays whether the processor is Hyper-Threading (HT) capable.
64-Bit Technology	Displays whether 64-bit technology is used.
Memory Information	

Table 31. System setup options—Overview menu (continued)

Overview	
Memory Installed	Displays the total computer memory installed.
Memory Available	Displays the total computer memory available.
Memory Speed	Displays the memory speed.
Memory Channel Mode	Displays single or dual channel mode.
Memory Technology	Displays the technology that is used for the memory.
Devices Information	
Panel Type	Displays the Panel Type of the computer.
Panel Resolution	Displays the Panel Resolution of the computer.
Video Controller	Displays the video controller type of the computer.
Video Memory	Displays the video memory information of the computer.
Wi-Fi Device	Displays the wireless device information of the computer.
Native Resolution	Displays the native resolution of the computer.
Video BIOS Version	Displays the video BIOS version of the computer.
Audio Controller	Displays the audio controller information of the computer.
Bluetooth Device	Displays the Bluetooth device information of the computer.
dGPU Graphics Controller	Displays the dGPU Graphics Controller information of the computer.

Table 32. System setup options—Boot Configuration menu

Boot Configuration	
Boot Sequence	
Boot Mode: UEFI only	Displays the boot mode of the computer.
Boot Sequence	Displays the boot sequence.
Secure Digital (SD) Card Boot	Enables or disables read-only boot from Secure Digital (SD) card. By default, the Secure Digital (SD) Card Boot option is enabled.
Secure Boot	Secure Boot is a method of guaranteeing the integrity of the boot path by performing additional validation of the operating system and PCI add-in cards. The computer stops booting to the operating system when a component is not authenticated during the boot process. Secure Boot can be enabled in BIOS setup or using management interfaces like Dell Command Configure, but can only be disabled from BIOS setup.
Enable Secure Boot	Enables the computer to boot using only validated boot software. By default, the Enable Secure Boot option is enabled. For additional security, Dell Technologies recommends keeping the Secure Boot option enabled to ensure that the UEFI firmware validates the operating system during the boot process. <div style="border-left: 1px solid black; padding-left: 10px; margin-left: 20px;"> <p>i NOTE: For Secure Boot to be enabled, the computer is required to be in UEFI boot mode and the Enable Legacy Option ROMs option is required to be turned off.</p> </div>
Secure Boot Mode	Enables or disables the Secure Boot operation mode. By default, the Deployed Mode is selected. <div style="border-left: 1px solid black; padding-left: 10px; margin-left: 20px;"> <p>i NOTE: Deployed Mode should be selected for normal operation of Secure Boot.</p> </div>

Table 32. System setup options—Boot Configuration menu (continued)

Boot Configuration	
Enable Microsoft UEFI CA	<p>When disabled, the UEFI CA is removed from the BIOS UEFI Secure Boot database.</p> <p>i NOTE: When disabled, the Microsoft UEFI CA could render your computer unable to boot, computer graphics may not function, some devices may not function properly, and the computer could become unrecoverable.</p> <p>By default, the Enable Microsoft UEFI CA option is enabled.</p> <p>For additional security, Dell Technologies recommends keeping the Microsoft UEFI CA option enabled to ensure the broadest compatibility with devices and operating systems.</p>
Expert Key Management	
Enable Custom Mode	<p>Enables or disables the keys in the PK, KEK, db, and dbx security key databases to be modified.</p> <p>By default, the Enable Custom Mode option is disabled.</p>
Custom Mode Key Management	<p>Selects the custom values for expert key management.</p> <p>By default, the PK option is selected.</p>

Table 33. System setup options—Integrated Devices menu

Integrated Devices	
Date/Time	
Date	Sets the computer date in MM/DD/YYYY format. Changes to the date format take effect immediately.
Time	Sets the computer time in HH/MM/SS 24-hour format. You can switch between a 12-hour and 24-hour clock. Changes to the time format take effect immediately.
Camera	
Enable Camera	<p>Enables the camera.</p> <p>By default, the Enable Camera option is enabled.</p> <p>i NOTE: Depending on the configuration ordered, the camera setup option may not be available.</p>
Audio	
Enable Audio	<p>Enables all integrated audio controller.</p> <p>By default, all the options are enabled.</p>
Enable Microphone	<p>Enables the microphone.</p> <p>By default, the Secure Digital (SD) Card Read-Only Mode option is disabled.</p> <p>ult, the Enable Microphone option is enabled.</p> <p>i NOTE: Depending on the configuration ordered, the microphone setup option may not be available.</p>
USB/Thunderbolt Configuration	
Enable USB Boot Support	<p>Enables booting from USB mass storage devices that are connected to external USB ports.</p> <p>By default, the Enable USB Boot Support option is enabled.</p>
Enable External USB Ports	<p>Enables the external USB ports.</p> <p>By default, the Enable External USB Ports option is enabled.</p>
Enable Thunderbolt Boot Support	

Table 33. System setup options—Integrated Devices menu (continued)

Integrated Devices	
Enable Thunderbolt Boot Support	Enables the Thunderbolt adapter-peripheral device and USB devices that are connected to the Thunderbolt adapter to be used during BIOS Preboot. By default, the Enable Thunderbolt Boot Support option is disabled.
Enable Thunderbolt (and PCIe behind TBT) pre-boot modules	Enables the PCIe devices that are connected through a Thunderbolt adapter to run the PCIe devices UEFI Option ROM (if present) during preboot. By default, the Enable Thunderbolt (and PCIe behind TBT) pre-boot modules option is disabled.

Table 34. System setup options—Storage menu

Storage	
SATA/NVMe Operation	
SATA/NVMe Operation	Sets the operating mode of the integrated SATA hard drive controller. By default, the AHCI/NVMe option is selected. The storage device is configured for AHCI/NVMe mode.
Storage Interface	
Port Enablement	Enables or disables the M.2 PCIe SSD option. By default, the M.2 PCIe SSD option is enabled.
SMART Reporting	
Enable SMART Reporting	When enabled, the BIOS can receive analytical information from integrated drives and send notifications during startup about possible future failure of the hard drive. By default, the Enable SMART Reporting option is disabled.
Drive Information	
Enable MediaCard	
Secure Digital (SD) Card	Enables or disables the SD card. By default, the Secure Digital (SD) Card option is enabled.
Secure Digital (SD) Card Read-Only Mode	Enables or disables the SD card read-only mode.

Table 35. System setup options—Display menu

Display	
Display Brightness	
Brightness on battery power	Enables to set the screen brightness when the computer is running on battery power. By default, the screen brightness is set to 50 when the computer is running on battery power.
Brightness on AC power	Enables to set the screen brightness when the computer is running on AC power. By default, the screen brightness is set to 100 when the computer is running on AC power.
Full Screen Logo	
Enables or disables the computer to display a full-screen logo, if the image matches screen resolution. By default, the Full Screen Logo option is disabled.	
Hybrid Graphics/ Advanced Optimus	
Allows both the integrates and discrete graphics controllers to work together for optimized capability and battery life. By default, the Hybrid Graphics/ Advanced Optimus option is enabled.	

Table 36. System setup options—Connection menu

Connection	
Wireless Device Enable	
WLAN	Enables or disables the internal WLAN device. By default, the WLAN option enabled.
Bluetooth	Enables or disables the internal Bluetooth device. By default, the Bluetooth option enabled.
Enable UEFI Network Stack	Enables or disables the UEFI Network Stack and controls the onboard LAN Controller. By default, the Enable UEFI Network Stack option is enabled.
HTTP(s) Boot Feature	

Table 37. System setup options—Power menu

Power	
Battery Configuration	Enables or disables the computer to run on battery during peak power usage hours. Use the table Custom Charge Start and Custom Charge Stop , to prevent AC power usage between certain times of each day. By default, the Adaptive option is selected. Battery settings are adaptively optimized based on your typical battery usage pattern.
Advanced Configuration	
Enable Advanced Battery Charge Configuration	Enables Advanced Battery Charge Configuration from the beginning of the day to a specified work period. When enabled, Advanced Battery Charged maximizes battery health while still supporting heavy use during the work day. By default, the Enable Advanced Battery Charge Configuration option is disabled.
Peak Shift	
Enable Peak Shift	Enables the computer to run on battery during peak power usage hours. By default, the Enable Peak Shift option is disabled.
Thermal Management	Enables or disables cooling of fan and manages processor heat to adjust the computer performance, noise, and temperature. By default, the Optimized option is selected. Standard setting for balanced performance, noise, and temperature.
USB PowerShare	
Wake on Dell USB-C Dock	When enabled, connecting a Dell USB-C Dock wakes the computer from Standby, Hibernate, and Power Off. By default, the Wake on Dell USB-C Dock option is enabled.
Block Sleep	Enables or disables the computer from entering Sleep (S3) mode in the operating system. By default, the Block Sleep option is disabled. i NOTE: When enabled, the computer does not go to Sleep, Intel Rapid Start is disabled automatically, and the operating system power option is blank if it was set to Sleep.
Lid Switch	
Enable Lid Switch	Enables or disables the Lid Switch. By default, the Enable Lid Switch option is enabled.

Table 37. System setup options—Power menu (continued)

Power	
Power On Lid Open	When enabled, it allows the computer to turn on from the off state whenever the lid is opened. By default, the Power On Lid Open option is enabled.
Intel Speed Shift Technology	Enables or disables the Intel Speed Shift Technology support. When enabled, the operating system selects the appropriate processor performance automatically. By default, the Intel Speed Shift Technology option is enabled.

Table 38. System setup options—Security menu



Security	
Intel Platform Trust Technology (PTT)	Intel PTT is a firmware-based Trusted Platform Module (fTPM) device that is part of Intel chipsets. It provides credential storage and key management that can replace the equivalent functionality of a discrete TPM chip.  NOTE: The options that are listed apply to computers with a discrete Trusted Platform Module (TPM) .
PTT On	Enables or disables the Intel PTT option. By default, the PTT On option is enabled. For additional security, Dell Technologies recommends keeping the PTT On option enabled.
Physical Presence Interface (PPI) Bypass for Clear Commands	The PPI Bypass for Clear Commands option allows the operating system to manage certain aspects of PTT. When enabled, you are not prompted to confirm changes to the PTT configuration. By default, the PPI Bypass for Clear Commands option is disabled. For additional security, Dell Technologies recommends keeping the PPI Bypass for Clear Commands option disabled.
Clear	When enabled, the Clear option clears the information that is stored in the PTT fTPM after exiting the computer's BIOS. This option returns to the disabled state when the computer restarts. By default, the Clear option is disabled. Dell Technologies recommends enabling the Clear option only when PTT fTPM data needs to be cleared.
SMM Security Mitigation	Enables or disables additional UEFI SMM Security Mitigation protections. This option uses the Windows SMM Security Mitigations Table (WSMT) to confirm to the operating system that security best practices have been implemented by the UEFI firmware. By default, the SMM Security Mitigation option is enabled. For additional security, Dell Technologies recommends keeping the SMM Security Mitigation option enabled unless you have a specific application which is not compatible.  NOTE: This feature may cause compatibility issues or loss of functionality with some legacy tools and applications.
Data Wipe on Next Boot	
Start Data Wipe	Data Wipe is a secure wipe operation that deletes information from a storage device.  CAUTION: The secure Data Wipe operation deletes information in a way that it cannot be reconstructed. Commands such as delete and format in the operating system may remove files from showing up in the file system. However, they can be reconstructed through forensic

Table 38. System setup options—Security menu (continued)

Security	
	<p>means as they are still represented on the physical media. Data Wipe prevents this reconstruction and is not recoverable.</p> <p>When enabled, the data wipe option will prompt to wipe any storage devices that are connected to the computer on the next boot.</p> <p>By default, the Start Data Wipe option is disabled.</p>
Absolute	<p>Absolute Software provides various cyber security solutions, some requiring software preloaded on Dell computers and integrated into the BIOS. To use these features, you must enable the Absolute BIOS setting and contact Absolute for configuration and activation.</p> <p>By default, the Absolute option is enabled.</p> <p>For additional security, Dell Technologies recommends keeping the Absolute option enabled.</p> <p>i NOTE: When the Absolute features are activated, the Absolute integration cannot be disabled from the BIOS setup screen.</p>
UEFI Boot Path Security	<p>Enables or disables the computer to prompt the user to enter the Administrator password (if set) when booting to a UEFI boot path device from the F12 boot menu.</p> <p>By default, the Always Except Internal HDD option is enabled.</p>
Firmware Device Tamper Detection	<p>Allows you to control the firmware device tamper detection feature. This feature notifies the user when the firmware device is tampered. When enabled, a screen warning messages are displayed on the computer and a tamper detection event is logged in the BIOS Events log. The computer fails to reboot until the event is cleared.</p> <p>By default, the Firmware Device Tamper Detection option is enabled.</p> <p>For additional security, Dell Technologies recommends keeping the Firmware Device Tamper Detection option enabled.</p>

Table 39. System setup options—Passwords menu

Passwords	
Administrator Password	<p>The Administrator Password prevents unauthorized access to the BIOS Setup options. Once the administrator password is set, the BIOS setup options can only be modified after providing the correct password.</p> <p>The following rules and dependencies apply to the Administrator Password -</p> <ul style="list-style-type: none"> • The administrator password cannot be set if computer and/or internal hard drive passwords are previously set. • The administrator password can be used in place of the computer and/or internal hard drive passwords. • When set, the administrator password must be provided during a firmware update. • Clearing the administrator password also clears the computer password (if set). <p>Dell Technologies recommends using an administrator password to prevent unauthorized changes to BIOS setup options.</p>
System Password	<p>The System Password prevents the computer from booting to an operating system without entering the correct password.</p> <p>The following rules and dependencies apply when the System Password is used -</p> <ul style="list-style-type: none"> • The computer shuts down when idle for approximately 10 minutes at the computer password prompt. • The computer shuts down after three incorrect attempts to enter the computer password.

Table 39. System setup options—Passwords menu (continued)

<p>Passwords</p>	<ul style="list-style-type: none"> • The computer shuts down when the Esc key is pressed at the System Password prompt. • The computer password is not prompted when the computer resumes from standby mode. <p>Dell Technologies recommends using the computer password in situations where it is likely that a computer may be lost or stolen.</p>
<p>Hard Drive Password</p>	<p>The Hard Drive Password can be set to prevent unauthorized access of the data stored on the hard drive. The computer prompts for the hard drive password during boot in order to unlock the drive. A password-secured hard drive stays locked even when removed from the computer or placed into another computer. It prevents an attacker from accessing data on the drive without authorization.</p> <p>The following rules and dependencies apply when the Hard Drive Password is used -</p> <ul style="list-style-type: none"> • The hard drive password option cannot be accessed when a hard drive is disabled in the BIOS setup. • The computer shuts down when idle for approximately 10 minutes at the hard drive password prompt. • The computer shuts down after three incorrect attempts to enter the hard drive password and treats the hard drive as not available. • The hard drive does not accept password unlock attempts after five incorrect attempts to enter the hard drive password from the BIOS Setup. The hard drive password must be reset for the new password unlock attempts. • The computer treats the hard drive as not available when the Esc key is pressed at the hard drive password prompt. • The hard drive password is not prompted when the computer resumes from standby mode. When the hard drive is unlocked by the user before the computer goes into standby mode, it remains unlocked after the computer resumes from standby mode. • If the computer and hard drive passwords are set to the same value, the hard drive unlocks after the correct computer password is entered. <p>Dell Technologies recommends using a hard drive password to protect unauthorized data access.</p>
<p>Owner Password</p>	<p>The Owner Password is typically used when a computer is loaned or leased, and the end user sets their own computer or hard drive password. The Owner Password can provide override access to unlock the computer when it is returned. The Owner Password cannot be set using BIOS Setup. System lessors are given a tool which enables them to configure the Owner Password.</p> <p>The following rules and dependencies apply when the Owner Password is used -</p> <ul style="list-style-type: none"> • The owner password cannot be set when the administrator password is already set. • The owner password can be used in place of the administrator, computer, or hard drive passwords. <p>NOTE: The hard drive password must have been set on the computer with the owner password.</p> <p>Dell Technologies recommends that only computer lessors use the owner password.</p>
<p>Strong Password</p>	<p>The Strong Password feature enforces stricter rules for administrator, owner, and computer passwords.</p> <p>When enabled, the following rules are enforced -</p> <ul style="list-style-type: none"> • The minimum length of the password is set to eight characters. • The password is required to include at least one upper case and one lower case character.

Table 39. System setup options—Passwords menu (continued)



Passwords	
	<p> NOTE: These requirements do not affect the hard drive password.</p> <p>By default, the Strong Password option is enabled.</p> <p>For additional security, Dell Technologies recommends keeping the Strong Password option enabled as it requires passwords to be more complex.</p>
Password Configuration	<p>The Password configuration page includes several options for changing the requirements of BIOS passwords. You can modify the minimum and maximum length of the passwords and require passwords to contain certain character classes (upper case, lower case, digit, special character).</p> <p>Dell Technologies recommends setting the minimum password length to at least eight characters.</p>
Password Bypass	<p>The Password Bypass option allows the computer to reboot from the operating system without entering the computer or hard drive password. If the computer has already booted to the operating system, it is presumed that the user has already entered the correct computer or hard drive password.</p> <p> NOTE: This option does not remove the requirement to enter the password after shutting down.</p> <p>By default, the Password Bypass option is enabled.</p> <p>For additional security, Dell Technologies recommends keeping the Password Bypass option enabled.</p>
Password Changes	
Allow Non-Admin Password Changes	<p>The Allow Non-Admin Password Changes option in BIOS setup allows an end user to set or change the computer or hard drive passwords without entering the administrator password. This gives an administrator control over the BIOS settings but enables an end user to provide their own password.</p> <p>By default, the Allow Non-Admin Password Changes option is disabled.</p> <p>For additional security, Dell Technologies recommends keeping the Allow Non-Admin Password Changes option disabled.</p>
Non-Admin Setup Changes	<p>The Non-Admin Setup Changes option allows an end user to configure the wireless devices without requiring the administrator password.</p> <p>By default, the Non-Admin Setup Changes option is disabled.</p> <p>For additional security, Dell Technologies recommends keeping the Non-Admin Setup Changes option disabled.</p>
Admin Setup Lockout	<p>The Admin Setup Lockout option prevents an end user from even viewing the BIOS setup configuration without first entering the administrator password (if set).</p> <p>By default, the Admin Setup Lockout option is disabled.</p> <p>For additional security, Dell Technologies recommends keeping the Admin Setup Lockout option disabled.</p>
Recovery Password	<p>The Recovery Password can be used when a system owner forgets the administrator, system, or hard drive password. You can get an unlock code from Dell Support over the phone after verifying ownership details. The unlock code overrides and removes the existing password.</p> <p> NOTE: When a hard drive password is overridden using this method, the data on the hard drive is erased if secure erase was enabled when setting the password.</p>
Master Password Lockout	
Enable Master Password Lockout	<p>The Master Password Lockout setting allows you to disable the Recovery Password feature. If the computer, administrator, or hard drive password is forgotten, the computer becomes unusable.</p>

Table 39. System setup options—Passwords menu (continued)

Passwords	
	<p>ⓘ NOTE: When the owner password is set, the Master Password Lockout option is not available.</p> <p>ⓘ NOTE: When an internal hard drive password is set, it must first be cleared before Master Password Lockout can be changed.</p> <p>By default, the Enable Master Password Lockout option is disabled.</p> <p>Dell does not recommend enabling the Master Password Lockout unless you have implemented your own password recovery computer.</p>

Table 40. System setup options—Update, Recovery menu

Update, Recovery	
UEFI Capsule Firmware Updates	
Enable UEFI Capsule Firmware Updates	<p>Enables or disables BIOS updates through UEFI capsule update packages.</p> <p>ⓘ NOTE: Disabling this option blocks the BIOS updates from services such as Microsoft Windows Update and Linux Vendor Firmware Service (LVFS).</p> <p>By default, the Enable UEFI Capsule Firmware Updates option is enabled.</p>
BIOS Recovery from Hard Drive	
	<p>Enables or disables the user to recover from certain corrupted BIOS conditions from a recovery file on the user primary hard drive or an external USB key.</p> <p>By default, the BIOS Recovery from Hard Drive option is enabled.</p> <p>ⓘ NOTE: BIOS Recovery from Hard Drive is not available for self-encrypting drives (SED).</p> <p>ⓘ NOTE: BIOS recovery is designed to fix the main BIOS block and cannot work if the Boot Block is damaged. In addition, this feature cannot work in the event of EC corruption, ME corruption, or a hardware issue. The recovery image must exist on an unencrypted partition on the drive.</p>
BIOS Downgrade	
Allow BIOS Downgrade	<p>Controls flashing of the computer firmware to previous revisions.</p> <p>By default, the Allow BIOS Downgrade option is enabled.</p>
SupportAssist OS Recovery	
	<p>Enables or disables the boot flow for SupportAssist OS Recovery tool in the event of certain computer errors.</p> <p>By default, the SupportAssist OS Recovery option is enabled.</p>
BIOSConnect	
	<p>Enables or disables cloud Service operating system recovery if the main operating system fails to boot with the number of failures equal to or greater than the value specified by the Auto operating system Recovery Threshold setup option and local Service operating system does not boot or is not installed.</p> <p>By default, the BIOSConnect option is enabled.</p>
Dell Auto OS Recovery Threshold	
	<p>Allows you to control the automatic boot flow for SupportAssist System Resolution Console and for Dell operating system Recovery Tool.</p> <p>By default, the Dell Auto OS Recovery Threshold value is set to 2.</p>

Table 41. System setup options—System Management menu

System Management	
Service Tag	Displays the Service Tag of the computer.
Asset Tag	Creates a computer Asset Tag that can be used by an IT administrator to uniquely identify a particular computer.

Table 41. System setup options—System Management menu (continued)

System Management	
 NOTE: Once set in BIOS, the Asset Tag cannot be changed.	
AC Behavior	
Wake on AC	<p>Enables or disables the computer to turn on and go to boot when AC power is supplied to the computer.</p> <p>By default, the Wake on AC option is disabled.</p>
Auto On Time	<p>Enable to set the computer to turn on automatically every day or on a preselected date and time. This option can be configured only if the Auto On Time is set to Everyday, Weekdays, or Selected Days.</p> <p>By default, the Auto On Time option is disabled.</p>
First Power On Date	
Set Ownership Date	<p>Allows you to set ownership date.</p> <p>By default, the First Power On Date option is disabled.</p>
Diagnostics	
OS Agent Requests	<p>When enabled, Dell OS Agent(s) will be capable of scheduling onboard diagnostics on a subsequent boot which can help assist in the prevention and resolution of hardware related issues.</p> <p>When disabled, Dell OS Agents(s) will not be capable of scheduling any onboard diagnostics and scans must be initiated manually in the pre-boot environment.</p>
Power-on-Self-Test Automatic Recovery	<p>When enabled, if the computer should become unresponsive before completing the BIOS Power-On-Self-Test (POST), the BIOS will attempt to automatically recover the computer.</p> <p>By default, the Power-on-Self-Test Automatic Recovery option is enabled.</p>

Table 42. System setup options—Keyboard menu

Keyboard	
Fn Lock Options	<p>Enables or disables the Fn Lock option.</p> <p>By default, the Fn Lock option is enabled.</p>
Lock Mode	<p>By default, the Lock Mode Secondary option is enabled. With this option, the F1-F12 keys scan the code for their secondary functions.</p>
RGB Per Key Keyboard Language	<p>Allows you to select the language that matches the keyboard installed on your system.</p>

Table 43. System setup options—Preboot Behavior menu

Preboot Behavior	
Adapter Warnings	
Enable Dock Warning Messages	<p>Enables the warning messages during boot when the adapters with less power capacity are detected.</p> <p>By default, the Enable Dock Warning Messages option is enabled.</p>
Warnings and Errors	<p>Enables or disables the action to be taken when a warning or error is encountered.</p> <p>By default, the Prompt on Warnings and Errors option is selected. Stop, prompt, and wait for user input when warnings or errors are detected.</p> <p> NOTE: Errors deemed critical to the operation of the computer hardware stop the functioning of the computer.</p>

Table 43. System setup options—Preboot Behavior menu (continued)

Preboot Behavior	
USB-C Warnings	
Enable Dock Warning Messages	Enables the warning messages during boot when the USB-C adapters with less power capacity are detected. By default, the Enable Dock Warning Messages option is enabled.
Fastboot	Allows you to configure the speed of the UEFI boot process. By default, the Thorough option is selected. Performs complete hardware and configuration initialization during boot.
Extend BIOS POST Time	Sets the BIOS POST (Power-On Self-Test) load time. By default, the 0 seconds option is selected.

Table 44. System setup options—Virtualization menu

Virtualization Support	
Intel Virtualization Technology	
Enable Intel Virtualization Technology (VT)	When enabled, the computer can run a Virtual Machine Monitor (VMM). By default, the Enable Intel Virtualization Technology (VT) option is enabled.
VT for Direct I/O	
Enable Intel VT for Direct I/O	When enabled, the computer can perform Virtualization Technology for Direct I/O (VT-d). VT-d is an Intel method that provides virtualization for memory map I/O. By default, the Enable Intel VT for Direct I/O option is enabled.
Intel Trusted Execution Technology (TXT)	Intel Trusted Execution Technology (TXT) is a set of hardware extensions to Intel processors and chipsets. It provides a hardware-based root of trust to ensure that a platform boots with a known good configuration of firmware, BIOS, virtual machine monitor, and operating system. The following must be enabled in order to enable Intel TXT - <ul style="list-style-type: none"> • Intel Virtualization Technology - X • Intel Virtualization Technology - Direct By default, the Intel Trusted Execution Technology (TXT) option is enabled. For additional security, Dell Technologies recommends keeping the Intel Trusted Execution Technology (TXT) option enabled.
DMA Protection	
Enable Pre-Boot DMA Support	Allows you to control the Pre-Boot DMA protection for both internal and external ports. This option does not directly enable DMA protection in the operating system. <i>i</i> NOTE: This option is not available when the virtualization setting for IOMMU is disabled (VT-d/AMD Vi). By default, the Enable Pre-Boot DMA Support option is enabled. For additional security, Dell Technologies recommends keeping the Enable Pre-Boot DMA Support option enabled. <i>i</i> NOTE: This option is provided only for compatibility purposes, since some older hardware is not DMA capable.
Enable OS Kernel DMA Support	Allows you to control the Kernel DMA protection for both internal and external ports. This option does not directly enable DMA protection in the operating system. For operating systems that support DMA protection, this setting indicates to the operating system that the BIOS supports the feature. <i>i</i> NOTE: This option is not available when the virtualization setting for IOMMU is disabled (VT-d/AMD Vi).

Table 44. System setup options—Virtualization menu (continued)

Virtualization Support	
	By default, the Enable OS Kernel DMA Support option is enabled.  NOTE: This option is provided only for compatibility purposes, since some older hardware is not DMA capable.

Table 45. System setup options—Performance menu

Performance	
Multi-Core Support	
Multiple Atom Cores	Enables to change the number of Atom cores available to the operating system. The default value is set to the maximum number of cores. By default, the All Cores option is selected.
Intel SpeedStep	
Enable Intel SpeedStep Technology	Enables the computer to dynamically adjust processor voltage and core frequency, decreasing average power consumption and heat production. By default, the Enable Intel SpeedStep Technology option is enabled.
C-State Control	
Enable C-State Control	Enables or disables the ability of the CPU to enter and exit low-power state. When disabled, it disables all C-states. When enabled, it enables all C-states that the chipset or platform allows. By default, the Enable C-State Control option is enabled.
Enable Adaptive C-States for Discrete Graphics	Enables the Adaptive C-States. When enabled, adaptive C-stated will allow for the system to dynamically detect high usage of a discrete graphics and adjust system parameters for higher performance during that time period. By default, the Enable Adaptive C-States for Discrete Graphics option is enabled.
Intel Turbo Boost Technology	
Enable Intel Turbo Boost Technology	Enables the Intel TurboBoost mode of the processor. When enabled, the Intel TurboBoost driver increases the performance of the CPU or graphics processor. By default, the Enable Intel Turbo Boost Technology option is enabled.
Intel Hyper-Threading Technology	
Enable Intel Hyper-Threading Technology	Enables the Intel Hyper-Threading mode of the processor. When enabled, the Intel Hyper-Threading increases the efficiency of the processor resources when multiple threads run on each core. By default, the Intel Hyper-Threading Technology option is enabled.
TCC Actication Offset	Allows you to adjust CPU's TCC offset. The higher TCC offset will moderate the CPU performance.

Table 46. System setup options—System Logs menu

System Logs	
BIOS Event Log	
Clear BIOS Event Log	Allows you to select option to keep or clear BIOS events logs. By default, the Keep Log option is selected.
Thermal Event Log	
Clear Thermal Event Log	Allows you to select option to keep or clear Thermal events logs.

Table 46. System setup options—System Logs menu (continued)

System Logs	
	By default, the Keep Log option is selected.
Power Event Log	
Clear Power Event Log	Allows you to select option to keep or clear Power events logs. By default, the Keep Log option is selected.

Updating the BIOS

Updating the BIOS in Windows

Steps

1. Go to [Dell Support Site](#).
2. Go to **Identify your product or search support**. In the box, enter the product identifier, model, service request or describe what you are looking for, and then click **Search**.
 **NOTE:** If you do not have the Service Tag, use the SupportAssist to automatically identify your computer. You can also use the product ID or manually browse for your computer model.
3. Click **Drivers & Downloads**. Expand **Find drivers**.
4. Select the operating system installed on your computer.
5. In the **Category** drop-down list, select **BIOS**.
6. Select the latest version of BIOS, and click **Download** to download the BIOS file for your computer.
7. After the download is complete, browse the folder where you saved the BIOS update file.
8. Double-click the BIOS update file icon and follow the on-screen instructions.
For more information about how to update the system BIOS, search in the Knowledge Base Resource at [Dell Support Site](#).

Updating the BIOS using the USB drive in Windows

Steps

1. Go to [Dell Support Site](#).
2. Go to **Identify your product or search support**. In the box, enter the product identifier, model, service request or describe what you are looking for, and then click **Search**.
 **NOTE:** If you do not have the Service Tag, use the SupportAssist to automatically identify your computer. You can also use the product ID or manually browse for your computer model.
3. Click **Drivers & Downloads**. Expand **Find drivers**.
4. Select the operating system installed on your computer.
5. In the **Category** drop-down list, select **BIOS**.
6. Select the latest version of BIOS, and click **Download** to download the BIOS file for your computer.
7. Create a bootable USB drive. For more information, search the Knowledge Base Resource at [Dell Support Site](#).
8. Copy the BIOS Setup program file to the bootable USB drive.
9. Connect the bootable USB drive to the computer that needs the BIOS update.
10. Restart the computer and press **F12**.
11. Select the USB drive from the **One Time Boot Menu**.
12. Type the BIOS Setup program filename and press **Enter**.
The **BIOS Update Utility** appears.
13. Follow the on-screen instructions to complete the BIOS update.

Updating the BIOS in Linux and Ubuntu

To update the system BIOS on a computer that is installed with Linux or Ubuntu, see the knowledge base article [000131486](#) at [Dell Support Site](#).

Updating the BIOS from the One-Time boot menu

You can run the BIOS flash update file from Windows using a bootable USB drive or you can also update the BIOS from the One-Time boot menu on the computer. To update your computers BIOS, copy the BIOS XXXX.exe file onto a USB drive formatted with the FAT32 file system. Then, restart your computer and boot from the USB drive using the One-Time Boot Menu.

About this task

BIOS Update

To confirm if the BIOS Flash Update is listed as a boot option you can boot your computer to the **One Time Boot** Menu. If the option is listed, then the BIOS can be updated using this method.

To update your BIOS from the One-Time boot menu, you need the following:

- USB drive formatted to the FAT32 file system (the drive does not have to be bootable)
- BIOS executable file that you downloaded from the Dell Support website and copied to the root of the USB drive
- AC power adapter must be connected to the computer
- A functional computer battery to flash the BIOS

Perform the following steps to update the BIOS from the One-Time boot menu:

 **CAUTION: Do not turn off the computer during the BIOS flash update process. The computer may not boot if you turn off your computer.**

Steps

1. Turn off the computer, insert the USB drive that contains the BIOS flash update file.
2. Turn on the computer and press **F12** to access the **One Time Boot** Menu. Select **BIOS Update** using the mouse or arrow keys then press Enter.
The flash BIOS menu is displayed.
3. Click **Flash from file**.
4. Select the external USB device.
5. Select the file and double-click the flash target file, and then click **Submit**.
6. Click **Update BIOS**. The computer restarts to flash the BIOS.
7. The computer will restart after the BIOS flash update is completed.

System and setup password

 **CAUTION: The password features provide a basic level of security for the data on your computer.**

 **CAUTION: Ensure that your computer is locked when it is not in use. Anyone can access the data that is stored on your computer, when left unattended.**

Table 47. System and setup password

Password type	Description
System password	Password that you must enter to boot to your operating system.
Setup password	Password that you must enter to access and change the BIOS settings of your computer.

You can create a system password and a setup password to secure your computer.

 **NOTE:** The System and setup password feature is disabled by default.

Assigning a System Setup password

Prerequisites

You can assign a new System or Admin Password only when the status is set to **Not Set**. To enter BIOS System Setup, press F2 immediately after a power-on or reboot.

Steps

1. In the **System BIOS** or **System Setup** screen, select **Security** and press Enter.
The **Security** screen is displayed.
2. Select **System/Admin Password** and create a password in the **Enter the new password** field.
Use the following guidelines to create the system password:
 - A password can have up to 32 characters.
 - A password can at least have one special character: "(! " # \$ % & ' * + , - . / : ; < = > ? @ [\] ^ _ ` { | })"
 - A password can have numbers 0 to 9.
 - A password can have an upper case letters from A to Z.
 - A password can have a lower case letters from a to z.
3. Type the system password that you entered earlier in the **Confirm new password** field and click **OK**.
4. Press Y to save the changes.
The computer restarts.

Deleting or changing an existing system password or setup password

Prerequisites

Ensure that the **Password Status** is Unlocked in the System Setup before attempting to delete or change the existing system password and/or setup password. You cannot delete or change an existing system password or setup password if the **Password Status** is Locked. To enter the System Setup, press F2 immediately after a power-on or reboot.

Steps

1. In the **System BIOS** or **System Setup** screen, select **System Security** and press Enter.
The **System Security** screen is displayed.
2. In the **System Security** screen, verify that the **Password Status** is Unlocked.
3. Select **System Password**. Update or delete the existing system password, and press Enter or Tab.
4. Select **Setup Password**. Update or delete the existing setup password, and press Enter or Tab.
 **NOTE:** If you change the system password and/or setup password, reenter the new password when prompted. If you delete the system password and/or setup password, confirm the deletion when prompted.
5. Press Esc. A message prompts you to save the changes.
6. Press Y to save the changes and exit from **System Setup**.
The computer restarts.

Clearing system and setup passwords

About this task

To clear the system or setup passwords, contact Dell technical support as described at [Contact Support](#).

-  **NOTE:** For information about how to reset Windows or application passwords, see the documentation accompanying Windows or your application.

Troubleshooting

Handling swollen rechargeable Li-ion batteries

Like most laptops, Dell laptops use Lithium-ion batteries. One type of Lithium-ion battery is the rechargeable Li-ion battery. Rechargeable Li-ion batteries have increased in popularity in recent years and have become a standard in the electronics industry due to customer preferences for a slim form factor (especially with newer ultra-thin laptops) and long battery life. Inherent to rechargeable Li-ion battery technology is the potential for swelling of the battery cells.

A swollen battery may impact the performance of the laptop. To prevent possible further damage to the device enclosure or internal components leading to malfunction, discontinue the use of the laptop and discharge it by disconnecting the AC adapter and letting the battery drain.

Swollen batteries should not be used and must be replaced and disposed of properly. We recommend contacting Dell Support for options to replace a swollen battery under the terms of the applicable warranty or service contract, including options for replacement by a Dell authorized service technician.

The guidelines for handling and replacing rechargeable Li-ion batteries are as follows:

- Exercise caution when handling rechargeable Li-ion batteries.
- Discharge the battery before removing it from the laptop. To discharge the battery, unplug the AC adapter from the computer and operate the computer only on battery power. The battery is fully discharged when the computer no longer turns on when the power button is pressed.
- Do not crush, drop, mutilate, or penetrate the battery with foreign objects.
- Do not expose the battery to high temperatures, or disassemble battery packs and cells.
- Do not apply pressure to the surface of the battery.
- Do not bend the battery.
- Do not use tools of any type to pry on or against the battery.
- If a battery gets stuck in a device as a result of swelling, do not try to free it as puncturing, bending, or crushing a battery can be dangerous.
- Do not attempt to reassemble a damaged or swollen battery into a laptop.
- Swollen batteries that are covered under warranty should be returned to Dell in an approved shipping container (provided by Dell)—this is to comply with transportation regulations. Swollen batteries that are not covered under warranty should be disposed of at an approved recycling center. Contact Dell Support at [Dell Support Site](#) for assistance and further instructions.
- Using a non-Dell or incompatible battery may increase the risk of fire or explosion. Replace the battery only with a compatible battery purchased from Dell that is designed to work with your Dell computer. Do not use a battery from other computers with your computer. Always purchase genuine batteries from [Dell Site](#) or otherwise directly from Dell.

Rechargeable Li-ion batteries can swell for various reasons such as age, number of charge cycles, or exposure to high heat. For more information about how to improve the performance and lifespan of the laptop battery and to minimize the possibility of occurrence of the issue, search Dell laptop battery in the Knowledge Base Resource at [Dell Support Site](#).

Locating the Service Tag or Express Service Code of your Dell computer

Your Dell computer is uniquely identified with a Service Tag or Express Service Code. To view relevant support resources for your Dell computer, we recommend entering the Service Tag or Express Service Code at [Dell Support Site](#).

For more information about how to find the Service Tag for your computer, see [Instructions on how to find your Service Tag or Serial Number](#).

Dell SupportAssist Pre-boot System Performance Check diagnostics

About this task

SupportAssist diagnostics (also known as system diagnostics) performs a complete check of your hardware. The Dell SupportAssist Pre-boot System Performance Check diagnostics is embedded within the BIOS and launched by the BIOS internally. The embedded system diagnostics provides options for particular devices or device groups allowing you to:

- Run tests automatically or in an interactive mode.
- Repeat the tests.
- Display or save test results.
- Run thorough tests to add more options and obtain details about any failed devices.
- View status messages that inform you when the tests are completed successfully.
- View error messages that inform you of problems encountered during testing.

NOTE: Some tests for specific devices require user interaction. Always ensure that you are present at the computer when the diagnostic tests are performed.

For more information, see the knowledge base article [000181163](#).

Running the SupportAssist Pre-Boot System Performance Check

Steps

1. Turn on your computer.
2. As the computer boots, press the F12 key.
3. On the boot menu screen, select **Diagnostics**.
The diagnostic quick test begins.

NOTE: For more information about running the SupportAssist Pre-Boot System Performance Check on a specific device, see [Dell Support Site](#),

4. If there are any issues, error codes are displayed.
Note the error code and validation number and contact Dell.

Built-in self-test (BIST)

(Motherboard Built-In Self-Test) M-BIST

M-BIST is the system board built-in self-test diagnostics tool that improves the diagnostics accuracy of system board Embedded Controller (EC) failures.

NOTE: M-BIST can be manually initiated before Power On Self-Test (POST).

How to run M-BIST

NOTE: Before initiating M-BIST, ensure that the computer is in a power-off state.

1. Press and hold both the **M** key and the power button to initiate M-BIST.
2. The battery indicator LED may exhibit two states:
 - Off: No fault was detected.
 - Amber and White: Indicates a problem with the system board.
3. If there is a failure with the system board, the battery status LED flashes one of the following error codes for 30 seconds:

Table 48. LED error codes

Blinking Pattern		Possible Problem
Amber	White	
2	1	CPU Failure
2	8	LCD Power Rail Failure
1	1	TPM Detection Failure
2	4	Memory/RAM failure

- If there is no failure with the system board, the LCD cycles through the solid color screens (that are described in the LCD-BIST) for 30 seconds and then turn off.

Logical Built-in Self-test (L-BIST)

L-BIST is an enhancement to the single LED error code diagnostics and is automatically initiated during POST. L-BIST will check the LCD power rail. If there is no power being supplied to the LCD (that is if the L-BIST circuit fails), the battery status LED flashes either an error code [2,8] or an error code [2,7].

NOTE: If L-BIST fails, LCD-BIST cannot function as no power will be supplied to the LCD.

How to invoke the L-BIST

- Turn on your computer.
- If the computer does not start up normally, look at the battery status LED:
 - If the battery status LED flashes an error code [2,7], the display cable may not be connected properly.
 - If the battery status LED flashes an error code [2,8], there is a failure on the LCD power rail of the system board, hence there is no power that is supplied to the LCD.
- For cases, when a [2,7] error code is shown, check to see if the display cable is properly connected.
- For cases when a [2,8] error code is shown, replace the system board.

LCD Built-in Self-Test (LCD-BIST)

Dell laptops have a built-in diagnostic tool that helps you determine if the screen abnormality you are experiencing is an inherent problem with the LCD (screen) of the Dell laptop or with the video card (GPU) and computer settings.

When you notice screen abnormalities like flickering, distortion, clarity issues, fuzzy or blurry image, horizontal or vertical lines, color fade, it is always a good practice to isolate the LCD (screen) by running the LCD-BIST.

How to invoke the LCD-BIST

- Turn off your computer.
- Disconnect any peripherals that are connected to the computer. Connect only the AC adapter (charger) to the computer.
- Ensure that the LCD (screen) is clean (no dust particles on the surface of the screen).
- Press and hold the **D** key and press the power button to enter LCD-BIST mode. Continue to hold the **D** key until the computer boots up.
- The screen displays solid colors and changes colors on the entire screen to white, black, red, green, and blue twice.
- Then it displays the colors white, black, and red.
- Carefully inspect the screen for abnormalities (any lines, fuzzy color, or distortion on the screen).
- At the end of the last solid color (red), the computer shuts down.

NOTE: Dell SupportAssist Preboot diagnostics upon launch initiates an LCD-BIST first, expecting a user intervention to confirm functionality of the LCD.

System-diagnostic lights

This section lists the system-diagnostic lights of your Alienware x16 R2.

Table 49. System-diagnostic lights

Blinking pattern		Problem description	Suggested resolution
Amber	White		
1	1	TPM detection failure	Replace the system board.
1	2	Unrecoverable SPI Flash Failure	Replace the system board.
1	5	EC unable to program i-Fuse	Replace the system board.
1	6	Generic catch-all for ungraceful EC code flow errors	Disconnect all power source (AC, battery, coin cell) and drain flea power by pressing and holding down the power button for 3~5 seconds.
2	1	CPU failure	<ul style="list-style-type: none"> Run the Dell SupportAssist or Dell Diagnostics tool. If the problem persists, replace the system board.
2	2	System board failure (included BIOS corruption or ROM error)	<ul style="list-style-type: none"> Flash latest BIOS version If the problem persists, replace the system board.
2	3	No memory or RAM detected	<ul style="list-style-type: none"> Confirm that the memory module is installed properly. If the problem persists, replace the memory module.
2	4	Memory or RAM failure	<ul style="list-style-type: none"> Reset and swap memory modules among the slots. If the problem persists, replace the memory module.
2	5	Invalid memory installed	<ul style="list-style-type: none"> Reset and swap memory modules among the slots. If the problem persists, replace the memory module.
2	6	System board or Chipset Error	Replace the system board.
2	7	LCD failure (SBIOS message)	Replace the LCD module.
2	8	LCD failure (EC detection of power rail failure)	Replace the system board.
3	1	CMOS battery failure	<ul style="list-style-type: none"> Reset the main battery connection. If the problem persists, replace the main battery.
3	2	PCI or Video card or chip failure	Replace the system board.

Table 49. System-diagnostic lights (continued)

Blinking pattern		Problem description	Suggested resolution
Amber	White		
3	3	BIOS Recovery image not found	<ul style="list-style-type: none"> Flash latest BIOS version If the problem persists, replace the system board.
3	4	BIOS Recovery image found but invalid	<ul style="list-style-type: none"> Flash latest BIOS version If the problem persists, replace the system board.
3	5	Power rail failure	Replace the system board.
3	6	Flash corruption is detected by SBIOS.	<ul style="list-style-type: none"> Press the power button for over 25 seconds to do RTC reset. If the problem persists, replace the system board. Disconnect all power source (AC, battery, coin cell) and drain flea power by pressing and holding down the power button 3~5 seconds to ensure all power are drained. Run "BIOS recovery from USB", and the instructions are in the website Dell support. If the problem persists, replace the system board.
3	7	Timeout waiting on ME to reply to HECI message.	Replace the system board.

NOTE: Blinking 3-3-3 LEDs on Lock LED (Caps-Lock or Num-Lock), Power button LED (without Fingerprint reader), and Diagnostic LED indicates failure to provide input during LCD panel test on Dell SupportAssist Pre-boot System Performance. Check diagnostics.

Network power cycle

About this task

If your computer is unable to access the Internet due to network connectivity issues, reset your network devices by performing the following steps:

Steps

1. Turn off the computer.
2. Turn off the modem.

NOTE: Some Internet service providers (ISPs) provide a modem and router combo device.

3. Turn off the wireless router.
4. Wait for 30 seconds.
5. Turn on the wireless router.
6. Turn on the modem.
7. Turn on the computer.

Drain flea power (perform hard reset)

About this task

Flea power is the residual static electricity that remains in the computer even after it has been powered off and the battery is removed.

For your safety, and to protect the sensitive electronic components in your computer, you must drain residual flea power before removing or replacing any components in your computer.

Draining flea power, also known as a performing a "hard reset," is also a common troubleshooting step if your computer does not turn on or boot into the operating system.

Perform the following steps to drain the flea power:

Steps

1. Turn off the computer.
2. Disconnect the power adapter from the computer.
3. Remove the base cover.
4. Remove the battery.



CAUTION: The battery is a Field Replaceable Unit (FRU) and the removal and installation procedures are intended for authorized service technicians only.

5. Press and hold the power button for 20 seconds to drain the flea power.
6. Install the battery.
7. Install the base cover.
8. Connect the power adapter to the computer.
9. Turn on the computer.



NOTE: For more information about performing a hard reset, go to [Dell Support Site](#). On the menu bar at the top of the Support page, select Support > Support Library. In the Search field on the Support Library page, type the keyword, topic, or model number, and then click or tap the search icon to view the related articles.

Getting help and contacting Alienware

Self-help resources

You can get information and help on Alienware products and services using these online self-help resources:

Table 50. Alienware products and online self-help resources

Self-help resources	Resource location
Information about Alienware products and services	Alienware Support Site
Contact Support	In Windows search, type Contact Support , and press Enter .
Online help for operating system	Windows Support Site
Access top solutions, diagnostics, drivers and downloads, and learn more about your computer through videos, manuals, and documents.	Your Alienware computer is uniquely identified by a Service Tag or Express Service Code. To view relevant support resources for your Dell computer, enter the Service Tag or Express Service Code at Dell Support Site . For more information about how to find the Service Tag for your computer, see Instructions on how to find your Service Tag or Serial Number .
Videos providing step-by-step instructions to service your computer	Alienware Support Channel

Contacting Alienware

To contact Alienware for sales, technical support, or customer service issues, see [Alienware Support Site](#).

- ① **NOTE:** Availability of the services may vary depending on the country or region, and product.
- ① **NOTE:** If you do not have an active Internet connection, you can find contact information about your purchase invoice, packing slip, bill, or Dell product catalog.