

# XPS 16 9640

## Owner's Manual

## Notes, cautions, and warnings

 **NOTE:** A NOTE indicates important information that helps you make better use of your product.

 **CAUTION:** A CAUTION indicates either potential damage to hardware or loss of data and tells you how to avoid the problem.

 **WARNING:** A WARNING indicates a potential for property damage, personal injury, or death.

<b>Chapter 1: Views of XPS 16 9640</b>	<b>6</b>
Left	6
Right	6
Top	8
Active areas of the touchpad	9
Front	10
Bottom	11
Service Tag	11
<b>Chapter 2: Set up your XPS 16 9640</b>	<b>13</b>
<b>Chapter 3: Specifications of XPS 16 9640</b>	<b>15</b>
Dimensions and weight	15
Processor	15
Chipset	16
Operating system	17
Memory	17
External ports	17
Internal slots	18
Wireless module	18
Audio	19
Storage	19
Media-card reader	20
Keyboard	20
Keyboard shortcuts of XPS 16 9640	21
Camera	21
Touchpad	22
Power adapter	22
Battery	23
Display	24
Fingerprint reader	25
Sensor	25
GPU—Integrated	25
GPU—Discrete	26
Multiple display support matrix	26
Hardware security	26
Operating and storage environment	27
Dell support policy	27
Dell low blue light display	27
<b>Chapter 4: Working inside your computer</b>	<b>29</b>
Safety instructions	29
Before working inside your computer	29
Safety precautions	30

Electrostatic discharge—ESD protection.....	30
ESD field service kit .....	31
Transporting sensitive components.....	32
After working inside your computer.....	32
BitLocker.....	32
Recommended tools.....	32
Screw list.....	33
Major components of XPS 16 9640.....	33

**Chapter 5: Removing and installing Field Replaceable Units (FRUs)..... 36**

Base cover.....	36
Removing the base cover.....	36
Installing the base cover.....	39
Battery.....	41
Rechargeable Li-ion battery precautions.....	41
Removing the battery.....	42
Installing the battery.....	43
Battery cable.....	44
Removing the battery cable.....	44
Installing the battery cable.....	45
Fan.....	46
Removing the GPU fan.....	46
Installing the GPU fan.....	47
Removing the CPU fan.....	48
Installing the CPU fan.....	49
Solid-state drive.....	50
Removing the solid-state drive.....	50
Installing the solid-state drive.....	52
Heat sink.....	53
Removing the heat sink—Integrated GPUs.....	53
Installing the heat sink—Integrated GPU.....	54
Removing the heat sink—Discrete GPU.....	55
Installing the heat sink—Discrete GPU.....	57
Wireless-module shield.....	58
Removing the wireless-module shield.....	58
Installing the wireless-module shield.....	59
Display assembly.....	60
Removing the display assembly.....	60
Installing the display assembly.....	63
Type-C bracket.....	65
Removing the Type-C brackets.....	65
Installing the Type-C brackets.....	66
System board.....	67
Removing the system board .....	67
Installing the system board .....	70
Speakers.....	73
Removing the speakers.....	73
Installing the speakers.....	74
Keyboard.....	76
Removing the keyboard.....	76

Installing the keyboard.....	78
Power button with fingerprint reader.....	81
Removing the power button with fingerprint reader.....	81
Installing the power button with fingerprint reader.....	82
Palm-rest assembly.....	83
Removing the palm-rest assembly.....	83
Installing the palm-rest assembly.....	84
<b>Chapter 6: Software.....</b>	<b>86</b>
Operating system.....	86
Drivers and downloads.....	86
<b>Chapter 7: BIOS Setup.....</b>	<b>87</b>
Entering BIOS Setup program.....	87
Navigation keys.....	87
F12 One Time Boot menu.....	87
System setup options.....	88
Updating the BIOS.....	104
Updating the BIOS in Windows.....	104
Updating the BIOS using the USB drive in Windows.....	104
Updating the BIOS from the F12 One Time Boot menu.....	105
System and setup password.....	105
Assigning a System Setup password.....	106
Deleting or changing an existing system setup password.....	106
Clearing BIOS (System Setup) and System passwords.....	107
<b>Chapter 8: Troubleshooting.....</b>	<b>108</b>
Handling swollen rechargeable Li-ion batteries.....	108
Locate the Service Tag or Express Service Code of your Dell computer .....	108
Dell SupportAssist Pre-boot System Performance Check diagnostics.....	109
Running the SupportAssist Pre-Boot System Performance Check.....	109
Built-in self-test (BIST).....	109
M-BIST.....	109
LCD Power rail test (L-BIST).....	110
LCD Built-in Self-Test (BIST).....	110
System-diagnostic lights.....	111
Recovering the operating system.....	111
Real-Time Clock (RTC Reset).....	112
Backup media and recovery options.....	112
Wi-Fi power cycle.....	112
Drain residual flea power (perform hard reset).....	112
<b>Chapter 9: Getting help and contacting Dell Technologies.....</b>	<b>114</b>

# Views of XPS 16 9640

## Left



Figure 1. Left view

### 1. Thunderbolt 4.0 port with Power Delivery and DisplayPort (2)

Supports USB4, DisplayPort 2.1, Thunderbolt 4 and also enables you to connect to an external display using a display adapter. Provides data transfer rates of up to 40 Gbps for USB4 and Thunderbolt 4.

**NOTE:** You can connect a Dell Docking Station to the Thunderbolt 4 ports. For more information, search in the Knowledge Base Resource at the [Dell Support Site](#).

**NOTE:** Use the supplied USB Type-C to USB Type A and DisplayPort dongle to connect to a DisplayPort device.

**NOTE:** USB4 is backward compatible with USB 3.2, USB 2.0, and Thunderbolt 3.

**NOTE:** Thunderbolt 4 supports two 4K displays or one 8K display.

## Right



Figure 2. Right view

**For computers shipped with integrated Intel Arc Graphics, NVIDIA GeForce RTX 4050, or NVIDIA GeForce RTX 4060 GPUs:**

### 1. microSD-card slot v6.0

The microSD-card slot reads from and writes to the microSD card. The computer supports the following card types:

- Micro Secure Digital (microSD)
- Micro Secure Digital High Capacity (microSDHC)
- Micro Secure Digital Extended Capacity (microSDXC)

### 2. Thunderbolt 4.0 port with Power Delivery and DisplayPort

Supports USB4, DisplayPort 2.1, Thunderbolt 4 and also enables you to connect to an external display using a display adapter. Provides data transfer rates of up to 40 Gbps for USB4 and Thunderbolt 4.

**NOTE:** You can connect a Dell Docking Station to the Thunderbolt 4 ports. For more information, search in the Knowledge Base Resource at the [Dell Support Site](#).

**NOTE:** Use the supplied USB Type-C to USB Type A and DisplayPort dongle to connect to a DisplayPort device.

**NOTE:** USB4 is backward compatible with USB 3.2, USB 2.0, and Thunderbolt 3.

**NOTE:** Thunderbolt 4 supports two 4K displays or one 8K display.

### 3. Headphone and speaker port

Connect headphones, a headset (headphone and microphone combo), or speakers.

#### For computers shipped with NVIDIA GeForce RTX 4070 GPUs:

##### 1. microSD-card slot v6.0

The microSD-card slot reads from and writes to the microSD card. The computer supports the following card types:

- Micro Secure Digital (microSD)
- Micro Secure Digital High Capacity (microSDHC)
- Micro Secure Digital Extended Capacity (microSDXC)

##### 2. USB 3.2 Gen 2 (Type-C) port with DisplayPort

Connect devices such as external storage devices, printers, and external displays. Provides data transfer rate of up to 10 Gbps.

Supports DisplayPort 1.4 and also enables you to connect an external display using a display adapter.

**NOTE:** Use the supplied USB Type-C to USB Type-A and DisplayPort dongle to connect a DisplayPort device.

##### 3. Headphone and speaker port

Connect headphones, a headset (headphone and microphone combo), or speakers.

# Top

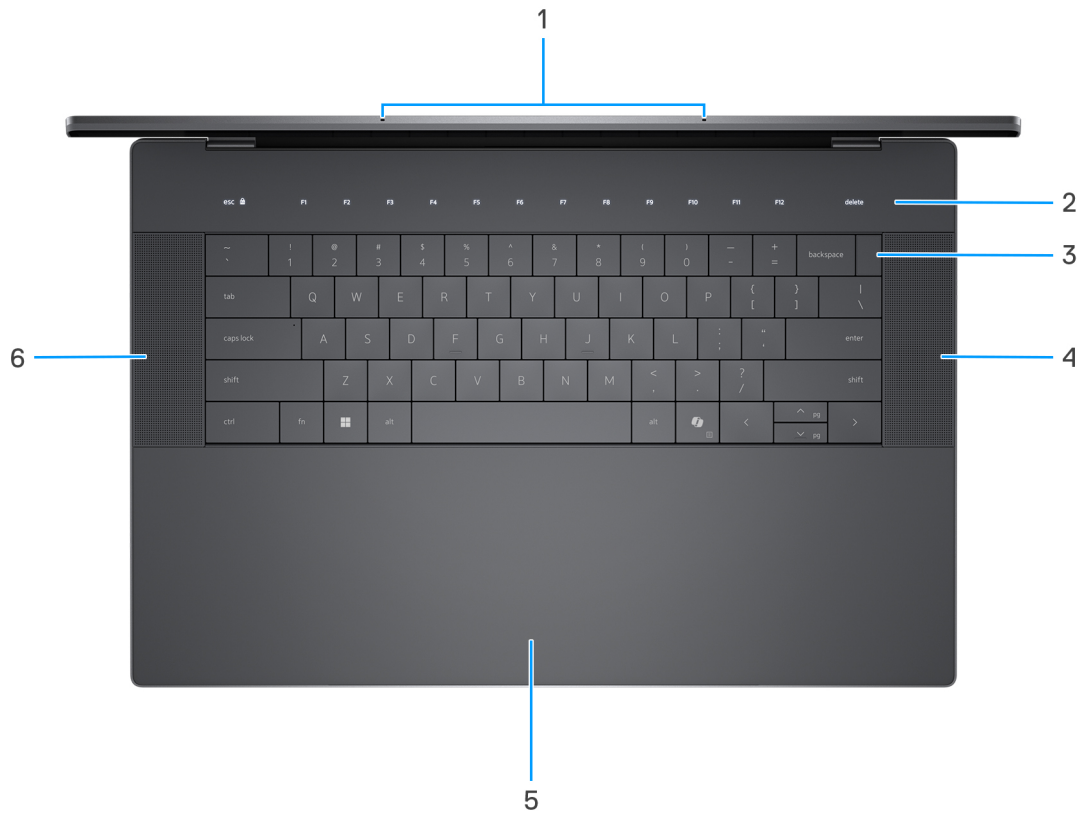

Figure 3. Top view

## 1. Microphones (2)

Provide digital sound input for audio recording, voice calls, and so on.

## 2. Capacitive touch function row

Displays media and display control keys or standard function keys, with the **esc** and **delete** keys.

Press and hold the **fn** key on the physical keyboard to switch to the next set of keys.

Press the **fn** key on the physical keyboard and the **esc** key on the capacitive touch function row to switch to the next set of keys and lock the mode of the panel.

## 3. Power button with fingerprint reader

Press to turn on the computer if it is turned off, in sleep state, or in a hibernating state. Place your finger on the power button steadily to log in.

When the computer is turned on, press the power button to put the computer into sleep state; press and hold the power button for 10 s to force shut-down the computer.

## 4. Right speaker

Provides audio output.

## 5. Touchpad

Move your finger on the touchpad to control the cursor. For more information about the active areas of the touchpad, see the section on [Active areas of the touchpad controls](#).

## 6. Left speaker

Provides audio output.



## Active areas of the touchpad

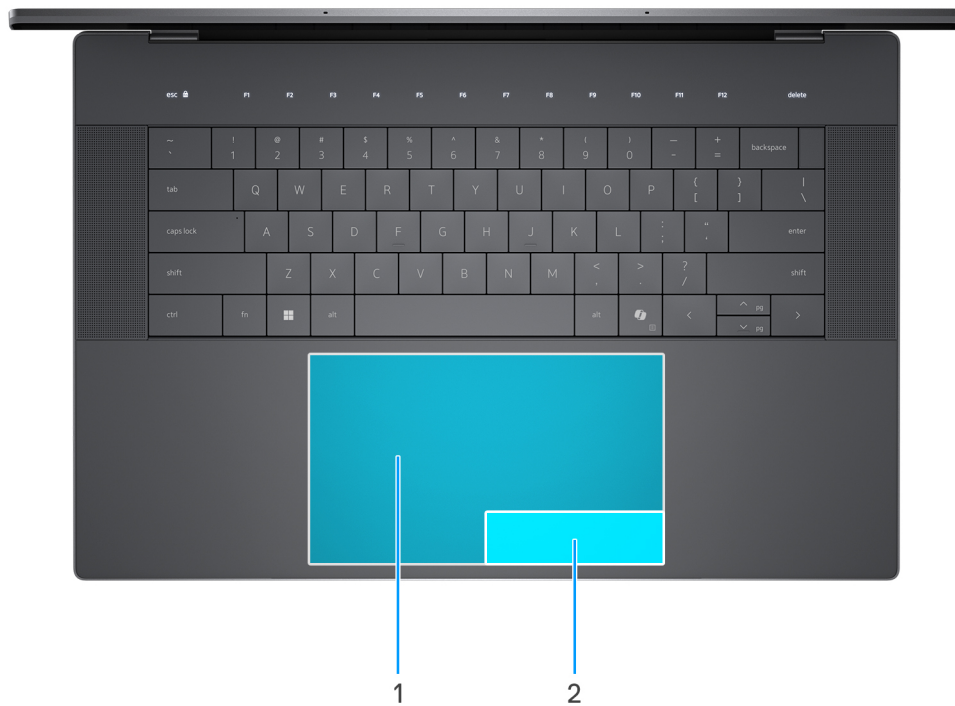

**Figure 4. Active areas of the touchpad**

**1. Left-click area of the touchpad**

Move your finger on the touchpad within this area to control the cursor. Tap this area to left-click.

**2. Right-click area of the touchpad**

Move your finger on the touchpad within this area to control the cursor. Tap this area to right-click.

# Front

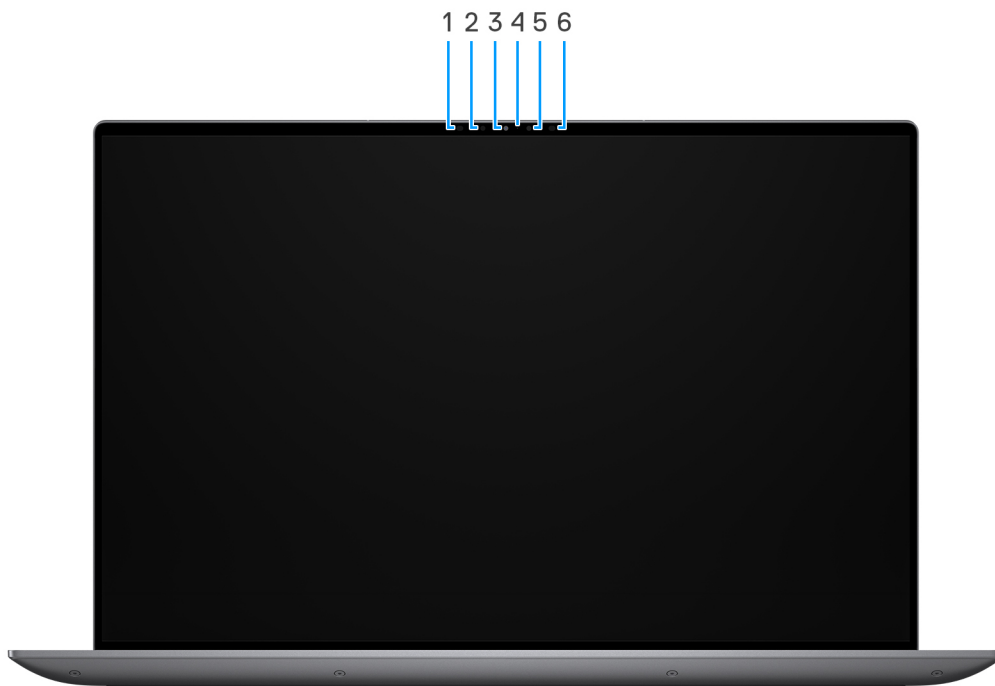

**Figure 5. Front view**

**1. Infrared emitter**

Emits infrared light, which enables the infrared camera to sense and track motion.

**2. Infrared camera**

Enhances security when paired with Windows Hello face authentication.

**3. Camera**

Enables you to video chat, capture photos, and record videos.

**4. Camera-status light**

Turns on when the camera is in use.

**5. Ambient-light sensor**

The sensor detects the ambient light and automatically adjusts the display brightness.

**6. Infrared emitter**

Emits infrared light, which enables the infrared camera to sense and track motion.

# Bottom

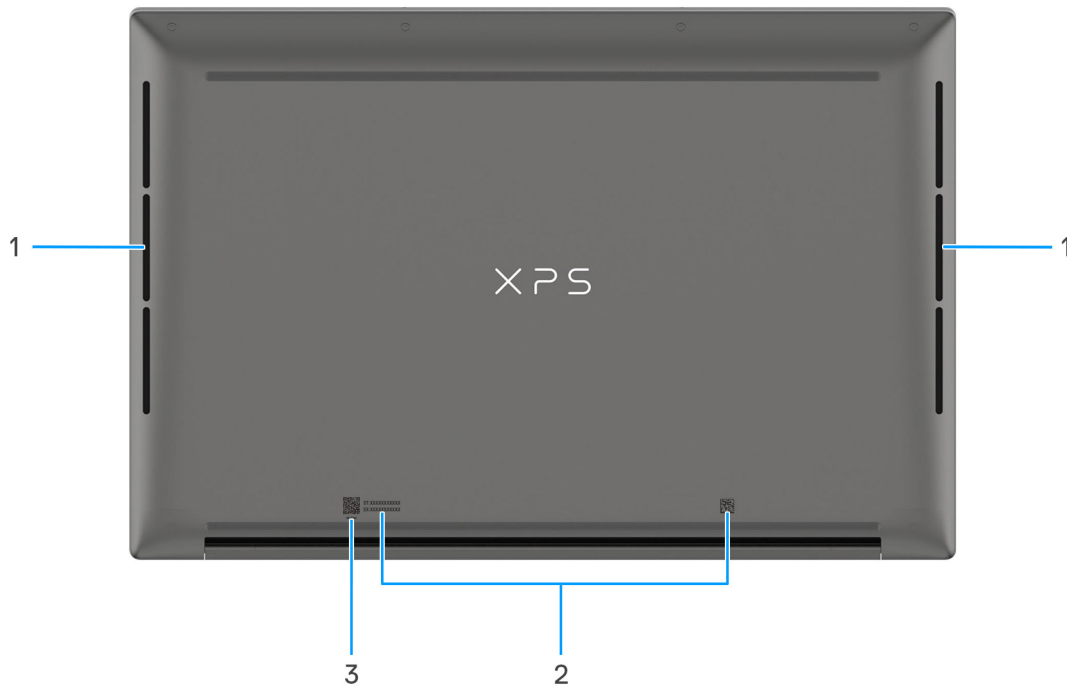

Figure 6. Bottom view

## 1. Speakers (2)

Provide audio output.

### Air vents

Air vents provide ventilation for your computer. Clogged air vents can cause overheating and can affect the performance of your computer and potentially cause hardware issues. Keep the air vents clear of obstructions and clean them regularly to prevent the build-up of dust and dirt. For more information about cleaning air vents, search for articles in the Knowledge Base Resource at the [Dell Support Site](#).

## 2. Service Tag label

The Service Tag is a unique alphanumeric identifier that enables Dell service technicians to identify the hardware components in your computer and access warranty information.

## 3. MyDell

MyDell provides a consolidated application experience housing capability that helps you get the most out of your computer. Intelligent, AI-based optimization features automatically fine-tune your computer for the best audio, video, battery, and performance. Each MyDell user experience is unique as the software learns and responds to the way you use your computer.

# Service Tag

The service tag is a unique alphanumeric identifier that allows Dell service technicians to identify the hardware components in your computer and access warranty information.



**Figure 7. Location of the Service Tag**

# Set up your XPS 16 9640

## About this task

**NOTE:** The images in this document may differ from your computer depending on the configuration you ordered.

## Steps

1. Connect the power adapter and press the power button.



**Figure 8. Connect the power adapter and press the power button**

**NOTE:** The battery may go into power-saving mode during shipment to conserve charge on the battery. Ensure that the power adapter is connected to your computer when it is turned on for the first time.

2. Finish the operating system setup.

### For Windows:

Follow the on-screen instructions to complete the setup. When setting up, Dell Technologies recommends that you:





- Connect to a network for Windows updates.

**NOTE:** If connecting to a secured wireless network, enter the password for the wireless network access when prompted.

- If connected to the Internet, sign in with or create a Microsoft account. If not connected to the Internet, create an offline account.
- On the **Support and Protection** screen, enter your contact details.

3. Locate and use Dell apps from the Windows Start menu—Recommended.

**Table 1. Locate Dell apps in Windows**

Resources	Description
 <p><b>Figure 9. My Dell</b></p>	<p><b>My Dell</b></p> <p>MyDell is a software application that offers you a single streamlined engagement platform including account access, device information, and hardware settings. This software delivers intelligent features that automatically fine-tune your computer for the best possible audio, power, and performance. Get the most out of your Dell device with intelligent, personalized technology from MyDell. Following are the key features of MyDell:</p> <ul style="list-style-type: none"> <li>● Application</li> <li>● Audio</li> <li>● Power</li> <li>● Color and Display</li> <li>● Presence detection</li> </ul> <p>For more information about how to use MyDell, see product guides at the <a href="#">Dell Support Site</a>.</p>
 <p><b>Figure 10. Dell Update</b></p>	<p><b>Dell Update</b></p> <p>Updates your computer with critical fixes and latest device drivers as they become available. For more information about using Dell Update, see the product guides and third-party license documents at the <a href="#">Dell Support site</a>.</p>
 <p><b>Figure 11. Dell Digital Delivery</b></p>	<p><b>Dell Digital Delivery</b></p> <p>Download software applications, which are purchased but not preinstalled on your computer. For more information about using Dell Digital Delivery, search in the Knowledge Base Resource at the <a href="#">Dell Support site</a>.</p>
 <p><b>Figure 12. Support Assist</b></p>	<p><b>SupportAssist</b></p> <p>SupportAssist proactively and predictively identifies hardware and software issues on your computer and automates the engagement process with Dell Technical support. It addresses performance and stabilization issues, prevents security threats, monitors, and detects hardware failures. For more information, see <i>SupportAssist for Home PCs User's Guide</i> at <a href="#">SupportAssist for Home PCs</a>.</p> <p><b>NOTE:</b> In SupportAssist, click the warranty expiry date to renew or upgrade your warranty.</p>

# Specifications of XPS 16 9640

## Dimensions and weight

The following table lists the height, width, depth, and weight of your XPS 16 9640.

**Table 2. Dimensions and weight**

Description	Values
Height	18.70 mm (0.74 in.)
Width	358.18 mm (14.10 in.)
Depth	240.05 mm (9.50 in.)
Weight  <b>NOTE:</b> The weight of your computer depends on the configuration that is ordered and manufacturing variability.	<ul style="list-style-type: none"> <li>• Minimum: 2.13 kg (4.70 lbs) for computers that are shipped with FHD+ panel</li> <li>• Minimum: 2.18 kg (4.80 lbs) for computers that are shipped with UHD+ panel</li> <li>• Maximum: 2.34 kg (5.15 lbs)</li> </ul>

## Processor

The following table lists the details of the processors that are supported for your XPS 16 9640.

**Table 3. Processor**

Description	Option one	Option two	Option three
Processor type	Intel Core Ultra 7 155H	Intel Core Ultra 7 165H	Intel Core Ultra 9 185H
Processor wattage	28 W	28 W	45 W
Processor total core count	16	16	16
Performance-cores	6	6	6
Efficient-cores	8	8	8
Processor total thread count  <b>NOTE:</b> Intel Hyper-Threading Technology is only available on Performance-cores.	22	22	22
Processor speed	Up to 4.8 GHz	Up to 5.0 GHz	Up to 5.1 GHz
Performance-cores frequency			
Processor base frequency	1.4 Ghz	1.4 Ghz	2.3 Ghz

**Table 3. Processor (continued)**

Description		Option one	Option two	Option three
	Maximum turbo frequency	4.8 Ghz	5.0 Ghz	5.1 Ghz
Efficient-cores frequency				
	Processor base frequency	0.9 Ghz	0.9 Ghz	1.8 Ghz
	Maximum turbo frequency	3.8 Ghz	3.8 Ghz	3.8 Ghz
Thermal Mode/Thermal Design Power (TDP)				
	Cool	<ul style="list-style-type: none"> <li>Type 4: 20 W + 20 W</li> <li>Type 3: 20 W + 20 W</li> <li>UMA: 30 W</li> </ul>	<ul style="list-style-type: none"> <li>Type 4: 20 W + 20 W</li> <li>Type 3: 20 W + 20 W</li> <li>UMA: 30 W</li> </ul>	<ul style="list-style-type: none"> <li>Type 4: 20 W + 20 W</li> <li>Type 3: 20 W + 20 W</li> <li>UMA: 30 W</li> </ul>
	Optimized	<ul style="list-style-type: none"> <li>Type 4: 20 W + 50 W</li> <li>Type 3: 20 W + 40 W</li> <li>UMA: 45 W</li> </ul>	<ul style="list-style-type: none"> <li>Type 4: 20 W + 50 W</li> <li>Type 3: 20 W + 40 W</li> <li>UMA: 45 W</li> </ul>	<ul style="list-style-type: none"> <li>Type 4: 20 W + 50 W</li> <li>Type 3: 20 W + 40 W</li> <li>UMA: 45 W</li> </ul>
	Quiet	<ul style="list-style-type: none"> <li>Type 4: 20 W + 40 W</li> <li>Type 3: 20 W + 30 W</li> <li>UMA: 30 W</li> </ul>	<ul style="list-style-type: none"> <li>Type 4: 20 W + 40 W</li> <li>Type 3: 20 W + 30 W</li> <li>UMA: 30 W</li> </ul>	<ul style="list-style-type: none"> <li>Type 4: 20 W + 40 W</li> <li>Type 3: 20 W + 30 W</li> <li>UMA: 30 W</li> </ul>
	Ultra Performance	<ul style="list-style-type: none"> <li>Type 4: 20 W + 60 W</li> <li>Type 3: 20 W + 50 W</li> <li>UMA: 55 W</li> </ul>	<ul style="list-style-type: none"> <li>Type 4: 20 W + 60 W</li> <li>Type 3: 20 W + 50 W</li> <li>UMA: 55 W</li> </ul>	<ul style="list-style-type: none"> <li>Type 4: 20 W + 60 W</li> <li>Type 3: 20 W + 50 W</li> <li>UMA: 55 W</li> </ul>
		<i>i</i> <b>NOTE:</b> Processor clock speeds and thermal design power differ according to the thermal mode selected in the My Dell app on your computer.		
	Processor cache	24 MB	24 MB	24 MB
	Integrated graphics	Intel Arc Graphics <i>i</i> <b>NOTE:</b> Requires 128-bit (Two-channel) memory populated	Intel Arc Graphics <i>i</i> <b>NOTE:</b> Requires 128-bit (Two-channel) memory populated	Intel Arc Graphics <i>i</i> <b>NOTE:</b> Requires 128-bit (Two-channel) memory populated

## Chipset

The following table lists the details of the chipset that is supported for your XPS 16 9640.

**Table 4. Chipset**

Description	Values
Chipset	Integrated with the processor
Processor	Intel Core Ultra 7 and 9 processors
DRAM bus width	128-bit (per 64-bit channel)
Flash EPROM	64 MB
PCIe bus	Up to Gen 5.0



# Operating system

Your XPS 16 9640 supports the following operating systems:

- Windows 11 Home, 64-bit
- Windows 11 Pro, 64-bit

# Memory

The following table lists the memory specifications of your XPS 16 9640.

**Table 5. Memory specifications**

Description	For computers shipped with Intel Arc Graphics	For computers shipped with NVIDIA GeForce RTX 4050 or NVIDIA GeForce RTX 4060 GPUs:	For computers shipped with NVIDIA GeForce RTX 4070 GPUs:
Memory slots	Onboard	Onboard	Onboard
Memory type	LPDDR5x	LPDDR5x	LPDDR5x
Memory speed	6400 MT/s	6400 MT/s	7467 MT/s
Maximum memory configuration	16 GB	64 GB	64 GB
Minimum memory configuration	16 GB	16 GB	32 GB
Memory configurations supported	16 GB: LPDDR5x, 6400 MT/s (onboard)	<ul style="list-style-type: none"> <li>• 16 GB: LPDDR5x, 6400 MT/s (onboard)</li> <li>• 32 GB: LPDDR5x, 6400 MT/s (onboard)</li> <li>• 64 GB: LPDDR5x, 6400 MT/s (onboard)</li> </ul>	<ul style="list-style-type: none"> <li>• 32 GB: LPDDR5x, 7467 MT/s (onboard)</li> <li>• 64 GB: LPDDR5x, 7467 MT/s (onboard)</li> </ul>

# External ports

The following table lists the external ports of your XPS 16 9640.

**Table 6. External ports**

Description	Values
Network port	Not supported
USB ports	<p>For computers that are shipped with integrated Intel Arc Graphics, NVIDIA GeForce RTX 4050, or NVIDIA GeForce RTX 4060 GPUs:</p> <ul style="list-style-type: none"> <li>• Three Thunderbolt 4 Gen 2 Type-C ports with DisplayPort Alt Mode/USB4 and PowerDelivery</li> </ul> <p>For computers that are shipped with NVIDIA GeForce RTX 4070 GPUs:</p> <ul style="list-style-type: none"> <li>• Two Thunderbolt 4 Gen 2 Type-C ports with DisplayPort Alt Mode/USB4 and PowerDelivery (Left side)</li> <li>• One USB 3.2 Gen 2 Type-C port with Power Delivery and DisplayPort (Right side)</li> </ul>
Audio port	One headphone/microphone combo jack (3.5mm)
Video port	Via Thunderbolt 4 (USB Type-C) ports

**Table 6. External ports (continued)**

Description	Values
Media-card reader	One microSD card slot v6.0
Power-adaptor port	USB Type-C
Security-cable slot	Not supported

## Internal slots

The following table lists the internal slots of your XPS 16 9640.

**Table 7. Internal slots**

Description	Values
M.2	One slot for M.2 2230 and M.2 2280 solid-state drive  <b>NOTE:</b> To learn more about the features of different types of M.2 cards, search in the Knowledge Base Resource at <a href="#">Dell Support Site</a> .

## Wireless module

The following table lists the Wireless Local Area Network (WLAN) module that is supported on your XPS 16 9640.

**Table 8. Wireless module specifications**

Description	Values
Model number	Intel Wi-Fi 7 BE200
Transfer rate	Up to 5760 Mbps
Frequency bands supported	2.4 GHz/5 GHz/6 GHz
Wireless standards	<ul style="list-style-type: none"> <li>• Wi-Fi 802.11a/b/g</li> <li>• Wi-Fi 4 (WiFi 802.11n)</li> <li>• Wi-Fi 5 (WiFi 802.11ac)</li> <li>• Wi-Fi 6E (WiFi 802.11ax)</li> <li>• Wi-Fi 7 (WiFi 802.11be)</li> </ul>
Encryption	<ul style="list-style-type: none"> <li>• 128-bit AES-CCMP</li> <li>• 256-bit AES-GCMP</li> </ul>
Bluetooth wireless card	Bluetooth 5.4
	 <b>NOTE:</b> The version of the Bluetooth wireless card may vary depending on the operating system that is installed on your computer.

# Audio

The following table lists the audio specifications of your XPS 16 9640.

**Table 9. Audio specifications**

Description		Values
Audio controller		Cirrus Logic CS42L43
Stereo conversion		Supported
Internal audio interface		SoundWire
External audio interface		Universal audio jack
Number of speakers		<ul style="list-style-type: none"><li>• 2 x Woofers</li><li>• 2 x Tweeters</li></ul>
Internal-speaker amplifier		Cirrus Logic CS35L56
External volume controls		Keyboard shortcut controls
Speaker output:		
	Average speaker output	<ul style="list-style-type: none"><li>• Woofer: 2 x 3 W</li><li>• Tweeters: 2 x 2 W</li></ul>
	Peak speaker output	<ul style="list-style-type: none"><li>• Woofer: 2 x 3.5 W</li><li>• Tweeters: 2 x 2.5 W</li></ul>
Subwoofer output		Not supported
Microphone		Digital-array microphones

# Storage

This section lists the storage options on your XPS 16 9640.

**Table 10. Storage specifications**

Storage type	Interface type	Capacity
M.2 2230, Class 35 solid-state drive	PCIe NVMe Gen4 x4	512 GB
M.2 2280, Class 40 solid-state drive	PCIe NVMe Gen4 x4	1 TB
M.2 2280, Class 40 solid-state drive	PCIe NVMe Gen4 x4	2 TB
M.2 2280, Class 40 solid-state drive	PCIe NVMe Gen4 x4	4 TB

## Media-card reader

The following table lists the media cards that are supported on your XPS 16 9640.

**Table 11. Media-card reader specifications**

Description	Values
Media-card type	One microSD card slot v6.0
Media-cards supported	<ul style="list-style-type: none"> <li>• Micro Secure Digital (microSD)</li> <li>• Micro Secure Digital High Capacity (microSDHC)</li> <li>• Micro Secure Digital Extended Capacity (microSDXC)</li> </ul>
<p><b>NOTE:</b> The maximum capacity that is supported by the media-card reader varies depending on the standard of the media card that is installed on your computer.</p>	

## Keyboard

The following table lists the keyboard specifications of your XPS 16 9640.

**Table 12. Keyboard specifications**

Description	Values
Keyboard type	Standard backlit <p><b>NOTE:</b> The top row of the keyboard is a capacitive touch panel which displays standard function keys or media and display control keys.</p>
Keyboard layout	QWERTY
Number of keys	<ul style="list-style-type: none"> <li>• United States and Canada: 64 keys</li> <li>• United Kingdom: 65 keys</li> <li>• Japan: 68 keys</li> </ul>
Keyboard size	X = 19.05 mm key pitch Y = 18.05 mm key pitch
Keyboard shortcuts	<p>Some keys on your keyboard have two symbols on them. These keys can be used to type alternate characters or to perform secondary functions. To type the alternate character, press Shift and the desired key. To perform secondary functions, press Fn and the desired key.</p> <p><b>NOTE:</b> You can define the primary behavior of the function keys (F1–F12) changing <b>Function Key Behavior</b> in BIOS setup program.</p> <p><b>NOTE:</b> If Copilot in Windows is not available on your computer, the Copilot key launches Windows Search. For more information about Copilot in Windows, search in the Knowledge Base Resource at <a href="#">dell support</a>.</p>

## Keyboard shortcuts of XPS 16 9640

**NOTE:** Keyboard characters may differ depending on the keyboard language configuration. Keys that are used for shortcuts remain the same across all language configurations.

Some keys on your keyboard have two symbols on them. These keys can be used to type alternate characters or to perform secondary functions. The symbol that is shown on the lower part of the key refers to the character that is typed out when the key is pressed. If you press **shift** and the key, the symbol that is shown on the upper part of the key is typed out. For example, if you press **2**, **2** is typed out; if you press **Shift + 2**, **@** is typed out.

The top row of the keyboard is a capacitive touch panel. The **fn** mechanical key toggles between the keys **F1-F12** and keys for multimedia control. Releasing the **fn** key switches back to the previous mode.

Pressing the **fn** key and the **esc** key locks the "mode" of the capacitive touch panel. If the computer restarts, the default mode is the last mode set by the user before the computer is restarted.

The **fn** key is also used with selected keys on the keyboard to invoke other secondary functions.

**Table 13. List of keyboard shortcuts**

Keyboard shortcut	Behavior
fn	Switch between modes of the capacitive touch panel
fn + B	Pause
fn + S	Toggle scroll lock
fn + R	System request
fn + ctrl + B	Break
fn + esc	Lock the mode of the capacitive touch panel
fn + left arrow	Home
fn + right arrow	End
Copilot	Launch Copilot in Windows <b>NOTE:</b> If Copilot in Windows is not available on your computer, the Copilot key launches Windows Search. For more information about Copilot in Windows, search in the Knowledge Base Resource at the <a href="#">Dell Support Site</a> .

## Camera

The following table lists the camera specifications of your XPS 16 9640.

**Table 14. Camera specifications**

Description	Values
Number of cameras	Two
Camera type	<ul style="list-style-type: none"> <li>FHD RGB camera</li> <li>IR camera</li> </ul>
Camera location	Front camera
Camera sensor type	CMOS sensor technology
Camera resolution:	
Still image	2.07 megapixel
Video	1920 x 1080 (FHD) at 30 fps

**Table 14. Camera specifications (continued)**

Description		Values
Infrared camera resolution:		
	Still image	0.23 megapixels
	Video	640 x 360 at 15 fps
Diagonal viewing angle:		
	Camera	81.30 degrees
	Infrared camera	78.10 degrees

## Touchpad

The following table lists the touchpad specifications of your XPS 16 9640.

**Table 15. Touchpad specifications**

Description		Values
Touchpad resolution:		> 300 DPI
Touchpad dimensions:		
	Horizontal	148 mm (5.83 in.)
	Vertical	90 mm (3.54 in.)
Touchpad gestures		For more information about touchpad gestures available on Windows, see the Microsoft Knowledge Base article at <a href="#">Microsoft Support Site</a> .

## Power adapter

The following table lists the power adapter specifications of your XPS 16 9640.

**Table 16. Power adapter specifications**

Description		Values
Type		130W AC small form factor adapter, USB Type-C, E5
Power-adapter dimensions:		
	Height	22 mm (0.87 in.)
	Width	55 mm (2.17 in.)
	Depth	128 mm (5.04 in.)
Input voltage		100 VAC to 240 VAC
Input frequency		50 to 60 Hz
Input current (maximum)		1.80 A
Output current (continuous)		<ul style="list-style-type: none"> <li>5 V/3 A</li> </ul>

**Table 16. Power adapter specifications (continued)**

Description		Values
		<ul style="list-style-type: none"> <li>9 V/3 A</li> <li>15 V/3 A</li> <li>20 V/6.5 A</li> </ul>
Rated output voltage		<ul style="list-style-type: none"> <li>5 VDC</li> <li>9 VDC</li> <li>15 VDC</li> <li>20 VDC</li> </ul>
Temperature range:		
	Operating	0°C to 35°C (32°F to 95°F)
	Storage	-40°C to 70°C (-40°F to 158°F)
 <b>CAUTION:</b> Operating and storage temperature ranges may differ among components, so operating or storing the device outside these ranges may impact the performance of specific components.		

## Battery

The following table lists the battery specifications of your XPS 16 9640.

**Table 17. Battery specifications**

Description		Values
Battery type		6-cell, 99.5 Wh lithium-polymer, ExpressCharge
Battery voltage		11.70 VDC
Battery weight (maximum)		0.38 kg (0.84 lb)
Battery dimensions:		
	Height	7.26 mm (0.29 in.)
	Width	289.00 mm (11.40 in.)
	Depth	84.40 mm (3.32 in.)
Temperature range:		
	Operating	<ul style="list-style-type: none"> <li>Charge: 0°C to 45°C (32°F to 113°F)</li> <li>Discharge: 0°C to 70°C (32°F to 158°F)</li> </ul>
	Storage	-20°C to 65°C (-4°F to 149°F)
Battery operating time		Varies depending on operating conditions and can significantly reduce under certain power-intensive conditions.
Battery charging time (approximate)  <b>NOTE:</b> Control the charging time, duration, start and end time, and so on, using the Dell Power Manager application. For more information about Dell Power Manager, search in the Knowledge Base Resource at <a href="#">Dell Support Site</a> .		<ul style="list-style-type: none"> <li>Standard charge, 0°C to 50°C (32°F to 122°F): 4 hours</li> <li>ExpressCharge, 0°C to 15°C (32°F to 59°F): 4 hours</li> <li>ExpressCharge, 16°C to 45°C (60.80°F to 113°F): 2 hours</li> <li>ExpressCharge, 46°C to 50°C (114.80°F to 122°F): 3 hours</li> </ul>

**Table 17. Battery specifications (continued)**

Description	Values
Coin-cell battery	Not supported
<p><b>⚠ CAUTION: Operating and storage temperature ranges may differ among components, so operating or storing the device outside these ranges may impact the performance of specific components.</b></p> <p><b>⚠ CAUTION: Dell Technologies recommends that you charge the battery regularly for optimal power consumption. If your battery charge is depleted, connect the power adapter, turn on your computer, and then restart your computer to reduce the power consumption.</b></p>	

## Display

The following table lists the display specifications of your XPS 16 9640.

**Table 18. Display specifications**

Description	Option one	Option two
Display type	White Light Emitting Diode Full High Definition Plus (WLED FHD+), InfinityEdge, Eyesafe technology, low blue light display (hardware solution)	Organic-Light Emitting Diode Ultra High Definition Plus (OLED UHD+), InfinityEdge, Eyesafe technology, low blue light display (hardware solution)
Touch options	No	Pen support, Passive pen
Display-panel technology	Wide Viewing Angle (WVA)	Wide Viewing Angle (WVA)
Display-panel dimensions (active area):		
	Height	219.17 mm (8.63 in.)
	Width	350.67 mm (13.81 in.)
	Diagonal	413.51 mm (16.28 in.)
Display-panel native resolution	1920 x 1200	3840 x 2400
Luminance (typical)	500 nits typical	400 nits typical
Megapixels	2.07	9.20
Color gamut	sRGB 100% typical	DCI-P3 100% typical
Pixels Per Inch (PPI)	139	278.10
Contrast ratio (minimum)	2000:1 typical	1,000,000:1 typical with SR-UL2
Response time (maximum)	35 ms	<ul style="list-style-type: none"> <li>● 1 ms typical</li> <li>● 2 ms maximum</li> </ul>
Refresh rate	30 to 120 Hz	48 to 90 Hz
Horizontal view angle	+/- 88 degrees typical	+/- 89 degrees typical
Vertical view angle	+/- 88 degrees typical	+/- 89 degrees typical
Pixel pitch	0.18 mm	0.09 mm



**Table 18. Display specifications (continued)**

Description	Option one	Option two
Power consumption (maximum)	<ul style="list-style-type: none"><li>4.21 W @120 Hz</li><li>3.51 W @60 Hz</li></ul>	<ul style="list-style-type: none"><li>9.70 W @90 Hz typical</li><li>11.71 W @90 Hz maximum</li></ul>
Anti-glare vs glossy finish	Anti-glare	Anti-reflective, Anti-smudge

## Fingerprint reader

The following table lists the fingerprint-reader specifications of your XPS 16 9640.

 **NOTE:** The fingerprint reader is on the power button.

**Table 19. Fingerprint reader specifications**

Description	Values
Fingerprint-reader sensor technology	Capacitive
Fingerprint-reader sensor resolution	500 dpi
Fingerprint-reader sensor pixel size	108 x 88

## Sensor

The following table lists the sensor of your XPS 16 9640.

**Table 20. Sensor**

Sensor support
Accelerometer in the base: ST Micro LIS2DW12TR
Ambient Light Sensor (ALS) for the panel backlight control: ams-OSRAM TCS35303

## GPU—Integrated

The following table lists the specifications of the integrated Graphics Processing Unit (GPU) supported by your XPS 16 9640.

**Table 21. GPU—Integrated**

Controller	Memory size	Processor
Intel Arc Graphics	Shared system memory	<ul style="list-style-type: none"><li>Intel Core Ultra 7 155H</li><li>Intel Core Ultra 7 165H</li><li>Intel Core Ultra 9 185H</li></ul>

# GPU—Discrete

The following table lists the specifications of the discrete Graphics Processing Unit (GPU) supported by your XPS 16 9640.

**Table 22. GPU—Discrete**

Controller	Memory size	Memory type
NVIDIA GeForce RTX 4050	6 GB	GDDR6
NVIDIA GeForce RTX 4060	8 GB	GDDR6
NVIDIA GeForce RTX 4070	8 GB	GDDR6

# Multiple display support matrix

The following table lists the multiple display support matrix for your XPS 16 9640.

**Table 23. Multiple display support matrix**

Graphics Card	Discrete Graphics Controller Direct Output Mode	Supported external displays with computer internal display on	Supported external displays with computer internal display off
NVIDIA GeForce RTX 4050 and 4060	Not supported	<ul style="list-style-type: none"> <li>Three connected displays with DisplayPort support up to 4K/ 60 Hz.</li> <li>One connected display with DisplayPort supports up to 8K/ 60 Hz:                             <ul style="list-style-type: none"> <li>One DisplayPort cable supports up to 8K/ 30 Hz, and</li> <li>Two DisplayPort cables support up to 8K/ 60Hz.</li> </ul> </li> </ul>	<ul style="list-style-type: none"> <li>Four connected displays with DisplayPort support up to 4K/ 60 Hz.</li> <li>Two connected displays with DisplayPort support up to 8K/ 60 Hz:                             <ul style="list-style-type: none"> <li>One DisplayPort cable supports up to 8K/ 30 Hz, and</li> <li>Two DisplayPort cables support up to 8K/ 60 Hz.</li> </ul> </li> </ul>
NVIDIA GeForce RTX 4070	Supported	<ul style="list-style-type: none"> <li>Three connected displays with DisplayPort support up to 4K/ 60 Hz.</li> <li>One connected display with DisplayPort supports up to 8K/ 60 Hz:                             <ul style="list-style-type: none"> <li>One DisplayPort cable supports up to 8K/ 30 Hz, and</li> <li>Two DisplayPort cables support up to 8K/ 60Hz.</li> </ul> </li> </ul>	<ul style="list-style-type: none"> <li>Four connected displays with DisplayPort support up to 4K/ 60 Hz.</li> <li>Two connected displays with DisplayPort support up to 8K/ 60 Hz:                             <ul style="list-style-type: none"> <li>One DisplayPort cable supports up to 8K/ 30 Hz, and</li> <li>Two DisplayPort cables support up to 8K/ 60 Hz.</li> </ul> </li> </ul>

# Hardware security

The following table lists the hardware security of your XPS 16 9640.

**Table 24. Hardware security**

Hardware security
Trusted Platform Module (TPM) 2.0
FIPS 140-2 Certified for TPM

**Table 24. Hardware security (continued)**

Hardware security
TCG Certification for TPM (Trusted Computing Group)
Windows Hello-compliant fingerprint reader in power button
Windows Hello camera in upper bezel

## Operating and storage environment

This table lists the operating and storage specifications of your XPS 16 9640.

**Airborne contaminant level:** G1 as defined by ISA-S71.04-1985

**Table 25. Computer environment**

Description	Operating	Storage
Temperature range	0°C to 35°C (32°F to 95°F)	-40°C to 65°C (-40°F to 149°F)
Relative humidity (maximum)	10% to 90% (non-condensing)	0% to 95% (non-condensing)
Vibration (maximum)*	0.66 GRMS	1.30 GRMS
Shock (maximum)	110 G†	160 G†
Altitude range	-15.2 m to 3048 m (4.64 ft to 5518.4 ft)	-15.2 m to 10668 m (4.64 ft to 19234.4 ft)
 <b>CAUTION: Operating and storage temperature ranges may differ among components, so operating or storing the device outside these ranges may impact the performance of specific components.</b>		

\* Measured using a random vibration spectrum that simulates the user environment.

† Measured using a 2 ms half-sine pulse.

## Dell support policy

For information about Dell support policy, search in the Knowledge Base Resource at [Dell Support Site](#).

## Dell low blue light display

 **WARNING: Prolonged exposure to blue light from the display may lead to long-term effects such as eye strain, eye fatigue, or damage to the eyes.**

Blue light is a color in the light spectrum which has a short wavelength and high energy. Chronic exposure to blue light, particularly from digital sources may disrupt sleep patterns and cause long-term effects such as eye strain, eye fatigue, or damage to the eyes.

The display on this computer is designed to minimize blue light and complies with TÜV Rheinland's requirement for low blue light (hardware solution) displays.

Low blue light (hardware solution) mode is enabled at the factory, so no further configuration is necessary.

To reduce the risk of eye strain, it is also recommended that you:











- Position the display at a comfortable viewing distance between 20 and 28 inches (50 cm and 70 cm) from your eyes.
- Blink frequently to moisten your eyes, wet your eyes with water, or apply suitable eye drops.
- Look away from your display, and gaze at a distant object at 20 ft (609.60 cm) away for at least 20 seconds during each break.

- Take an extended break for 20 minutes every two hours.

# Working inside your computer



## Safety instructions

Use the following safety guidelines to protect your computer from potential damage and to ensure your personal safety. Unless otherwise noted, each procedure in this document assumes that you have read the safety information that shipped with your computer.

-  **WARNING:** Before working inside your computer, read the safety information that is shipped with your computer. For more safety best practices, see [Dell Regulatory Compliance Home Page](#).
-  **WARNING:** Disconnect your computer from all power sources before opening the computer cover or panels. After you finish working inside the computer, replace all covers, panels, and screws before connecting your computer to an electrical outlet.
-  **CAUTION:** To avoid damaging the computer, ensure that the work surface is flat, dry, and clean.
-  **CAUTION:** To avoid damaging the components and cards, handle them by their edges, and avoid touching the pins and the contacts.
-  **CAUTION:** You should only perform troubleshooting and repairs as authorized or directed by the Dell technical assistance team. Damage due to servicing that is not authorized by Dell is not covered by your warranty. See the safety instructions that is shipped with the product or at [Dell Regulatory Compliance Home Page](#).
-  **CAUTION:** Before touching anything inside your computer, ground yourself by touching an unpainted metal surface, such as the metal at the back of the computer. While you work, periodically touch an unpainted metal surface to dissipate static electricity which could harm internal components.
-  **CAUTION:** When you disconnect a cable, pull it by its connector or its pull tab, not the cable itself. Some cables have connectors with locking tabs or thumbscrews that you must disengage before disconnecting the cable. When disconnecting cables, keep them evenly aligned to avoid bending the connector pins. When connecting cables, ensure that the ports and the connectors are correctly oriented and aligned.
-  **CAUTION:** Press and eject any installed card from the media-card reader.
-  **CAUTION:** Exercise caution when handling rechargeable Li-ion batteries in laptops. Swollen batteries should not be used and should be replaced and disposed properly.
-  **NOTE:** The color of your computer and certain components may differ from what is shown in this document.

## Before working inside your computer

### Steps

1. Save and close all open files and exit all open applications.
2. Shut down your computer. For Windows operating system, click **Start** >  **Power** > **Shut down**.
  -  **NOTE:** If you are using a different operating system, see the documentation of your operating system for shut-down instructions.
3. Disconnect your computer and all attached devices from their electrical outlets.
4. Disconnect all attached network devices and peripherals, such as keyboard, mouse, and monitor from your computer.
5. Remove any media card and optical disk from your computer, if applicable.

6. Enter the service mode, if you are able to power on your computer.

### Service Mode

Service Mode is used to cut-off power, without disconnecting battery cable from system board prior conducting repairs in the computer.

 **CAUTION:** If you are unable to turn on the computer to put it into Service Mode or the computer does not support Service Mode then proceed to disconnect the battery cable. To disconnect the battery cable, follow the steps in [Removing the battery](#).

 **NOTE:** Ensure that your computer is shut down and the AC adapter is disconnected.

- a. Hold **<B>** key on the keyboard and press the power button for 3 seconds or until the Dell logo appears on the screen.
- b. Press any key to continue.
- c. If the AC adapter is not disconnected, a message prompting you to remove the AC adapter appears on the screen. Remove the AC adapter and then press any key to continue the **Service Mode** procedure. The **Service Mode** procedure automatically skips the following step if the **Owner Tag** of the computer is not set up in advance by the user.
- d. When the ready-to-proceed message appears on the screen, press any key to proceed. The computer emits three short beeps and shuts down immediately.
- e. Once the computer shuts down, it has successfully entered Service Mode.

 **NOTE:** If you are unable to power on your computer or unable to enter service mode skip this process.

## Safety precautions

The safety precautions chapter details the primary steps to be taken before performing any disassembly instructions.

Observe the following safety precautions before you perform any installation or break-fix procedures involving disassembly or reassembly:

- Turn off the computer and all attached peripherals.
- Disconnect the computer and all attached peripherals from AC power.
- Disconnect all network cables, telephone, and telecommunications lines from the computer.
- Use an ESD field service kit when working inside any to avoid electrostatic discharge (ESD) damage.
- After removing any computer component, carefully place the removed component on an anti-static mat.
- Wear shoes with non-conductive rubber soles to reduce the chance of getting electrocuted.
- Unplugging, pressing, and holding the power button for 15 seconds should discharge residual power in the system board.

## Standby power

Dell products with standby power must be unplugged before you open the case. Systems that incorporate standby power are powered while turned off. The internal power enables the computer to be remotely turned on (Wake-on-LAN) and suspended into a sleep mode and has other advanced power management features.

## Bonding

Bonding is a method for connecting two or more grounding conductors to the same electrical potential. This is done by using a field service electrostatic discharge (ESD) kit. When connecting a bonding wire, ensure that it is connected to bare metal and never to a painted or nonmetal surface. The wrist strap should be secure and in full contact with your skin, and ensure that you remove all jewelry such as watches, bracelets, or rings prior to bonding yourself and the equipment.

## Electrostatic discharge—ESD protection

ESD is a major concern when you handle electronic components, especially sensitive components such as expansion cards, processors, memory DIMMs, and system boards. Slight charges can damage circuits in ways that may not be obvious, such as intermittent problems or a shortened product life span. As the industry pushes for lower power requirements and increased density, ESD protection is an increasing concern.

Due to the increased density of semiconductors used in recent Dell products, the sensitivity to static damage is now higher than in previous Dell products. For this reason, some previously approved methods of handling parts are no longer applicable.

Two recognized types of ESD damage are catastrophic and intermittent failures.

- **Catastrophic** – Catastrophic failures represent approximately 20 percent of ESD-related failures. The damage causes an immediate and complete loss of device functionality. An example of catastrophic failure is a memory DIMM that has received a static shock and immediately generates a "No POST/No Video" symptom with a beep code that is emitted for missing or nonfunctional memory.
- **Intermittent** – Intermittent failures represent approximately 80 percent of ESD-related failures. The high rate of intermittent failures means that most of the time when damage occurs, it is not immediately recognizable. The DIMM receives a static shock, but the tracing is merely weakened and does not immediately produce outward symptoms that are related to the damage. The weakened trace may take weeks or months to melt, and in the meantime may cause degradation of memory integrity, intermittent memory errors, and so on.

The more difficult type of damage to recognize and troubleshoot is the intermittent (also called latent or "walking wounded") failure.

Perform the following steps to prevent ESD damage:

- Use a wired ESD wrist strap that is properly grounded. The use of wireless anti-static straps is no longer allowed; they do not provide adequate protection. Touching the chassis before handling parts does not ensure adequate ESD protection on parts with increased sensitivity to ESD damage.
- Handle all static-sensitive components in a static-safe area. If possible, use anti-static floor pads and workbench pads.
- When unpacking a static-sensitive component from its shipping carton, do not remove the component from the anti-static packing material until you are ready to install the component. Before unwrapping the anti-static packaging, ensure that you discharge static electricity from your body.
- Before transporting a static-sensitive component, place it in an anti-static container or packaging.

## ESD field service kit

The unmonitored Field Service kit is the most commonly used service kit. Each Field Service kit includes three main components: anti-static mat, wrist strap, and bonding wire.

### Components of an ESD field service kit

The components of an ESD field service kit are:

- **Anti-Static Mat** – The anti-static mat is dissipative and parts can be placed on it during service procedures. When using an anti-static mat, your wrist strap should be snug and the bonding wire should be connected to the mat and to any bare metal on the computer being worked on. Once deployed properly, service parts can be removed from the ESD bag and placed directly on the mat. ESD-sensitive items are safe in your hand, on the ESD mat, in the computer, or inside a bag.
- **Wrist Strap and Bonding Wire** – The wrist strap and bonding wire can be either directly connected between your wrist and bare metal on the hardware if the ESD mat is not required, or connected to the anti-static mat to protect hardware that is temporarily placed on the mat. The physical connection of the wrist strap and bonding wire between your skin, the ESD mat, and the hardware is known as bonding. Use only Field Service kits with a wrist strap, mat, and bonding wire. Never use wireless wrist straps. Always be aware that the internal wires of a wrist strap are prone to damage from normal wear and tear, and must be checked regularly with a wrist strap tester in order to avoid accidental ESD hardware damage. It is recommended to test the wrist strap and bonding wire at least once per week.
- **ESD Wrist Strap Tester** – The wires inside an ESD strap are prone to damage over time. When using an unmonitored kit, it is a best practice to regularly test the strap prior to each service call, and at a minimum, test once per week. A wrist strap tester is the best method for doing this test. If you do not have your own wrist strap tester, check with your regional office to find out if they have one. To perform the test, plug the wrist-strap's bonding-wire into the tester while it is strapped to your wrist and push the button to test. A green LED is lit if the test is successful; a red LED is lit and an alarm sounds if the test fails.
- **Insulator Elements** – It is critical to keep ESD sensitive devices, such as plastic heat sink casings, away from internal parts that are insulators and often highly charged.
- **Working Environment** – Before deploying the ESD Field Service kit, assess the situation at the customer location. For example, deploying the kit for a server environment is different than for a desktop or laptop environment. Servers are typically installed in a rack within a data center; desktops or laptops are typically placed on office desks or cubicles. Always look for a large open flat work area that is free of clutter and large enough to deploy the ESD kit with additional space to accommodate the type of computer that is being repaired. The workspace should also be free of insulators that can cause an ESD event. On the work area, insulators such as Styrofoam and other plastics should always be moved at least 12 inches or 30 centimeters away from sensitive parts before physically handling any hardware components.

- **ESD Packaging** – All ESD-sensitive devices must be shipped and received in static-safe packaging. Metal, static-shielded bags are preferred. However, you should always return the damaged part using the same ESD bag and packaging that the new part arrived in. The ESD bag should be folded over and taped shut and all the same foam packing material should be used in the original box that the new part arrived in. ESD-sensitive devices should be removed from packaging only at an ESD-protected work surface, and parts should never be placed on top of the ESD bag because only the inside the bag is shielded. Always place parts in your hand, on the ESD mat, in the computer, or inside an anti-static bag.
- **Transporting Sensitive Components** – When transporting ESD sensitive components such as replacement parts or parts to be returned to Dell, it is critical to place these parts in anti-static bags for safe transport.

## ESD protection summary

It is recommended to use the traditional wired ESD grounding wrist strap and protective anti-static mat always when servicing Dell products. In addition, it is critical to keep sensitive parts separate from all insulator parts while performing service and that they use anti-static bags for transporting sensitive components.

## Transporting sensitive components

When transporting ESD sensitive components such as replacement parts or parts to be returned to Dell, it is critical to place these parts in anti-static bags for safe transport.

## After working inside your computer

### About this task

 **CAUTION:** Leaving stray or loose screws inside your computer may severely damage your computer.

### Steps

1. Replace all screws and ensure that no stray screws remain inside your computer.
2. Connect any external devices, peripherals, or cables you removed before working on your computer.
3. Replace any media cards, discs, or any other parts that you removed before working on your computer.
4. Connect your computer and all attached devices to their electrical outlets.
  -  **NOTE:** To exit service mode, ensure to connect the AC adapter to the power-adapter port on your computer.
5. Press the power button to turn on the computer. Your computer will automatically return to normal functioning mode.

## BitLocker

 **CAUTION:** If BitLocker is not suspended before updating the BIOS, the next time you reboot the system it will not recognize the BitLocker key. You will then be prompted to enter the recovery key to progress, and the system will ask for the recovery key on each reboot. If the recovery key is not known, this can result in data loss or an unnecessary operating system reinstall. For more information about this subject, see Knowledge Article: [updating the BIOS on Dell systems with BitLocker enabled](#).

The installation of the following components triggers BitLocker:

- Hard disk drive or solid-state drive
- System board

## Recommended tools

The procedures in this document may require the following tools:















- Phillips screwdriver #0
- Torx #5 (T5) screwdriver
- Plastic scribe



# Screw list

- NOTE:** When removing screws from a component, it is recommended to note the screw type, and the quantity of screws, and then place them in a screw storage box. This is to ensure that the correct number of screws and correct screw type is restored when the component is replaced.
- NOTE:** Some computers have magnetic surfaces. Ensure that the screws are not left attached to such surfaces when replacing a component.
- NOTE:** Screw color may vary with the configuration ordered.

**Table 26. Screw list**

Component	Screw type	Quantity	Screw image
Base cover	M2x4, T5	8	
Battery	M2x4.5	6	
Solid state drive thermal shield	M2x3	3	
CPU fan	M2x4.5	3	
GPU fan	M2x4.5	3	
Right hinge	M2.5x6	2	
Left hinge	M2.5x6	2	
Power button with fingerprint reader	M1.4x1.5	4	
Right Type-C bracket	M2x4.5	2	
Left Type C bracket	M2x4.5	3	
WLAN bracket	M2x3	1	
System board	M2x4.5	4	
Display-assembly cable bracket holder	M1.4x1.3	2	
Display-assembly cable bracket	M2x3	2	

## Major components of XPS 16 9640

The following image shows the major components of XPS 16 9640.

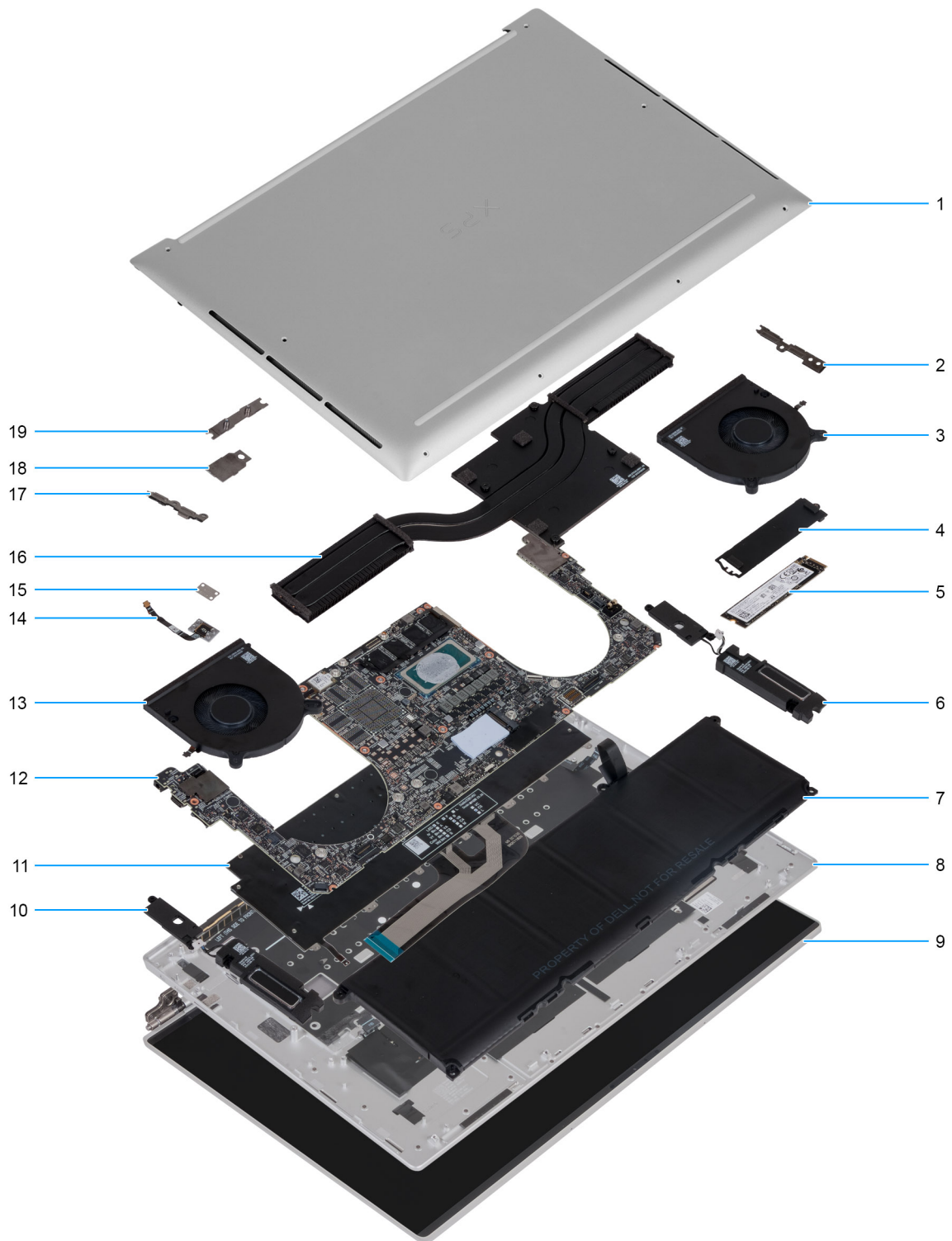

**Figure 13. Major components of XPS 16 9640**

- 1. Base cover
- 2. Left Type-C bracket
- 3. CPU fan
- 4. Solid-state drive thermal shield
- 5. Solid-state drive
- 6. Speaker (L)
- 7. Battery

8. Palm rest
9. Display assembly
10. Speaker (R)
11. Keyboard
12. System board
13. GPU fan
14. Power button with fingerprint reader
15. Power button shield
16. Heat sink
17. Right Type-C bracket
18. Wireless-module shield
19. Display cable connector bracket

 **NOTE:** Dell provides a list of components and their part numbers for the original computer configuration purchased. These parts are available according to warranty coverage purchased by the customer. Contact your Dell sales representative for purchase options.

# Removing and installing Field Replaceable Units (FRUs)

The replaceable components in this chapter are Field Replaceable Units (FRUs).

**CAUTION:** The information in this section is intended for authorized service technicians only.

**CAUTION:** To avoid any potential damage to the component or loss of data, ensure that an authorized service technician replaces the Field Replaceable Units (FRUs).

**CAUTION:** Dell Technologies recommends that this set of repairs, if needed, to be conducted by trained technical repair specialists.

**CAUTION:** As a reminder, your warranty does not cover damages that may occur during FRU repairs that are not authorized by Dell Technologies.

**NOTE:** The images in this document may differ from your computer depending on the configuration you ordered.

## Base cover

### Removing the base cover

**CAUTION:** The information in this removal section is intended for authorized service technicians only.

#### Prerequisites

1. Follow the procedure in [Before working inside your computer](#).

**NOTE:** Ensure that your computer is in Service Mode. For more information, see [Before working inside your computer](#).

**CAUTION:** If you are unable to turn on the computer, if your computer is unable to enter Service Mode, or the computer does not support Service Mode, then disconnect the battery cable.

#### About this task

**NOTE:** Before removing the base cover, ensure that there is no microSD card installed in the microSD card slot on your computer.

The following images indicate the location of the base cover and provide a visual representation of the removal procedure.



**8x**  
M2x4, T5



Figure 14. Removing the base cover



Figure 15. Removing the base cover



**Figure 16. Removing the base cover**

**Steps**

1. Remove the eight screws (M2x4, T5) that secure the base cover to the palm rest and keyboard assembly.
2. Place your thumbs and fingers into the recess at the top edge of the base cover.
3. Use both thumbs to pry the base cover to release it from the palm-rest assembly.
4. Lift the base cover off the palm rest and keyboard assembly.

**NOTE:** Ensure that your computer is in Service Mode. If your computer is unable to enter Service Mode, disconnect the battery cable from the system board.

5. Disconnect the battery cable from the connector (BATT) on the system board.
6. Press and hold the power button for five seconds to ground the computer and drain the flea power.

## Installing the base cover

**Prerequisites**

If you are replacing a component, remove the existing component before performing the installation process.

**About this task**

The following images indicate the location of the base cover and provide a visual representation of the installation procedure.



**8x**  
M2x4, T5



**Figure 17. Installing the base cover**



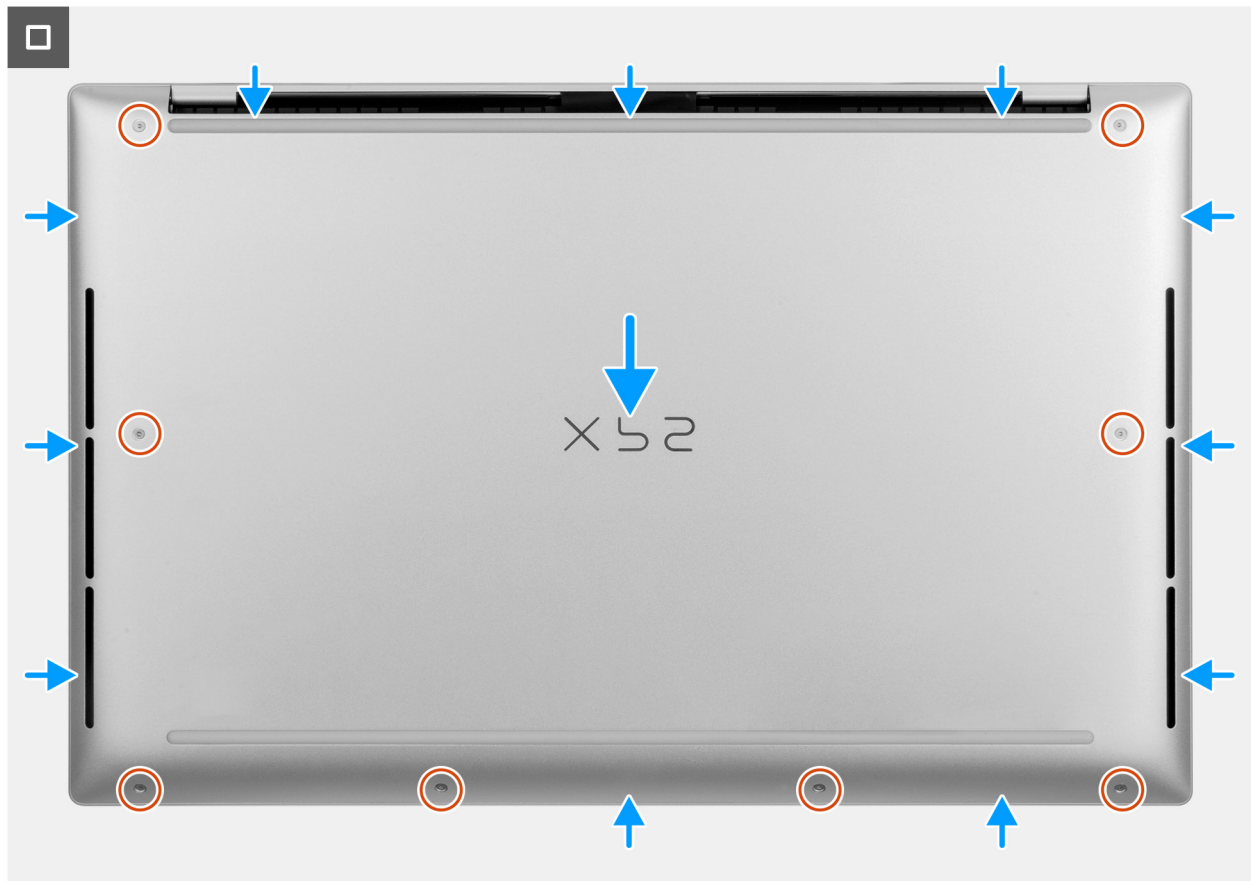

Figure 18. Installing the base cover

**NOTE:** If the battery is not a pre-requisite and if you have disconnected the battery cable, ensure to connect the battery cable. To connect the battery cable, follow step 1 and step 2 in the procedure.

#### Steps

1. Connect the battery cable to the connector (BATT) on the system board.
2. Align and place the base cover into the slots on the palm-rest assembly.
3. Replace the eight screws (M2x4, T5) that secure the base cover to the palm rest and keyboard assembly.

#### Next steps

1. Follow the procedure in [After working inside your computer](#).

**NOTE:** Ensure that your computer is in Service Mode. For more information, see [Before working inside your computer](#).

## Battery

### Rechargeable Li-ion battery precautions

#### CAUTION:

- Exercise caution when handling rechargeable Li-ion batteries.
- Discharge the battery completely before removing it. Disconnect the AC power adapter from the computer and operate the computer solely on battery power—the battery is fully discharged when the computer no longer turns on when the power button is pressed.
- Do not crush, drop, mutilate, or penetrate the battery with foreign objects.

- Do not expose the battery to high temperatures, or disassemble battery packs and cells.
- Do not apply pressure to the surface of the battery.
- Do not bend the battery.
- Do not use tools of any kind to pry on or against the battery.
- Ensure any screws during the servicing of this product are not lost or misplaced, to prevent accidental puncture or damage to the battery and other computer components.
- If the battery gets stuck inside your computer as a result of swelling, do not try to release it as puncturing, bending, or crushing a rechargeable Li-ion battery can be dangerous. In such an instance, contact Dell technical support for assistance. See [Contact Support at Dell Support Site](#).
- Always purchase genuine batteries from [Dell Site](#) or authorized Dell partners and resellers.
- Swollen batteries should not be used and should be replaced and disposed properly. For guidelines on how to handle and replace swollen rechargeable Li-ion batteries, see [Handling swollen rechargeable Li-ion batteries](#).

## Removing the battery

 **CAUTION:** The information in this removal section is intended for authorized service technicians only.

### Prerequisites

1. Follow the procedure in [Before working inside your computer](#).
2. Remove the [base cover](#).

### About this task

 **CAUTION:** Removing the battery resets the BIOS setup settings to default. It is recommended that you note the BIOS setup settings before removing the battery.

The following image indicates the location of the battery and provides a visual representation of the removal procedure.



6x  
M2x4.5

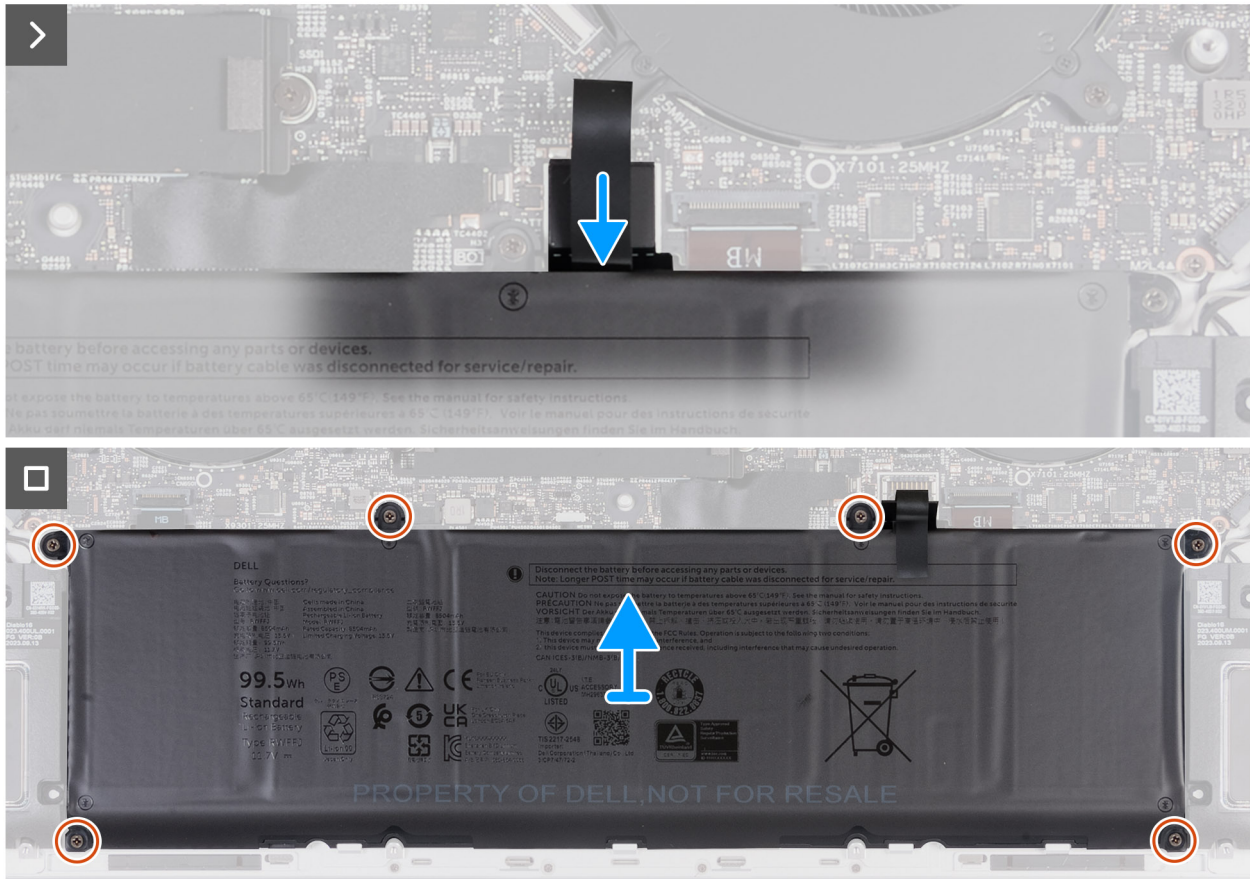
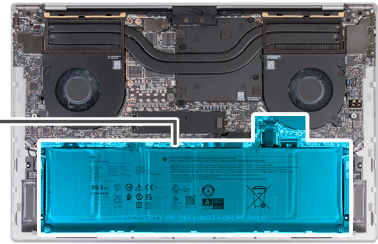
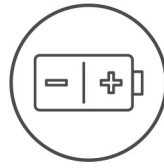

Figure 19. Removing the battery

### Steps

1. Disconnect the battery cable from the connector (BATT) on the system board, if not disconnected earlier.
2. Remove the six screws (M2x4.5) that secure the battery to the system board and palm-rest assembly.
3. Lift the battery off the palm-rest assembly.

## Installing the battery

**CAUTION:** The information in this installation section is intended for authorized service technicians only.

### Prerequisites

If you are replacing a component, remove the existing component before performing the installation process.

### About this task

The following image indicates the location of the battery and provides a visual representation of the installation procedure.

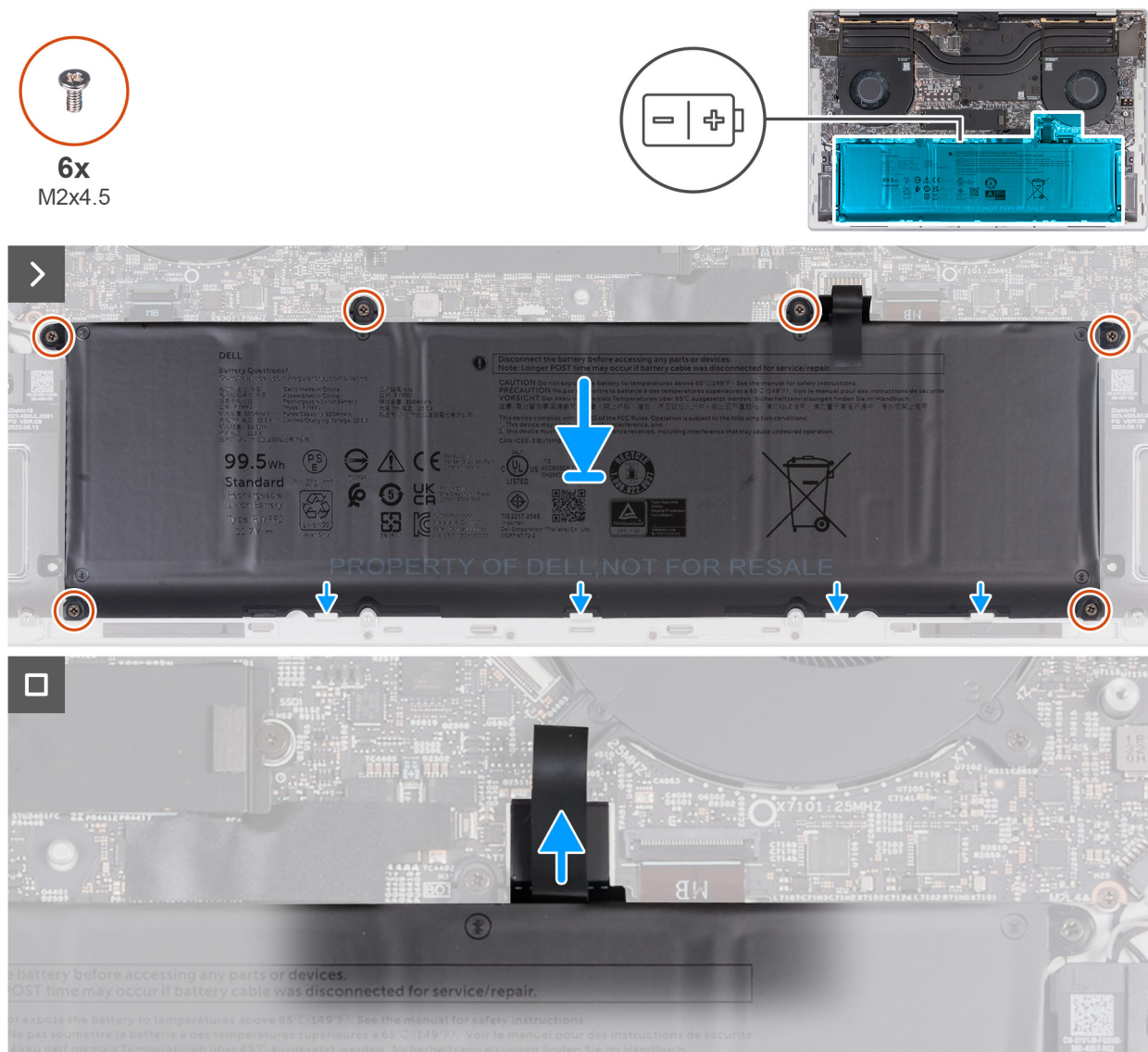

**Figure 20. Installing the battery**

### Steps

1. Using the alignment posts, place the battery on the palm-rest assembly.
2. Align the screw holes on the battery with the screw holes on the system board and palm-rest assembly.
3. Replace the six screws (M2x4.5) that secure the battery to the system board and palm-rest assembly.
4. Connect the battery cable to the connector (BATT) on the system board.

### Next steps

1. Install the [base cover](#).
2. Follow the procedure in [After working inside your computer](#).

## Battery cable

### Removing the battery cable

**CAUTION:** The information in this removal section is intended for authorized service technicians only.

### Prerequisites

1. Follow the procedure in [Before working inside your computer](#).
2. Remove the [base cover](#).
3. Remove the [battery](#).

### About this task

**NOTE:** If the battery is disconnected from the system board for service, there is a delay during boot as the computer undergoes an RTC battery reset.

The following image(s) indicate the location of the battery cable and provides a visual representation of the removal procedure.

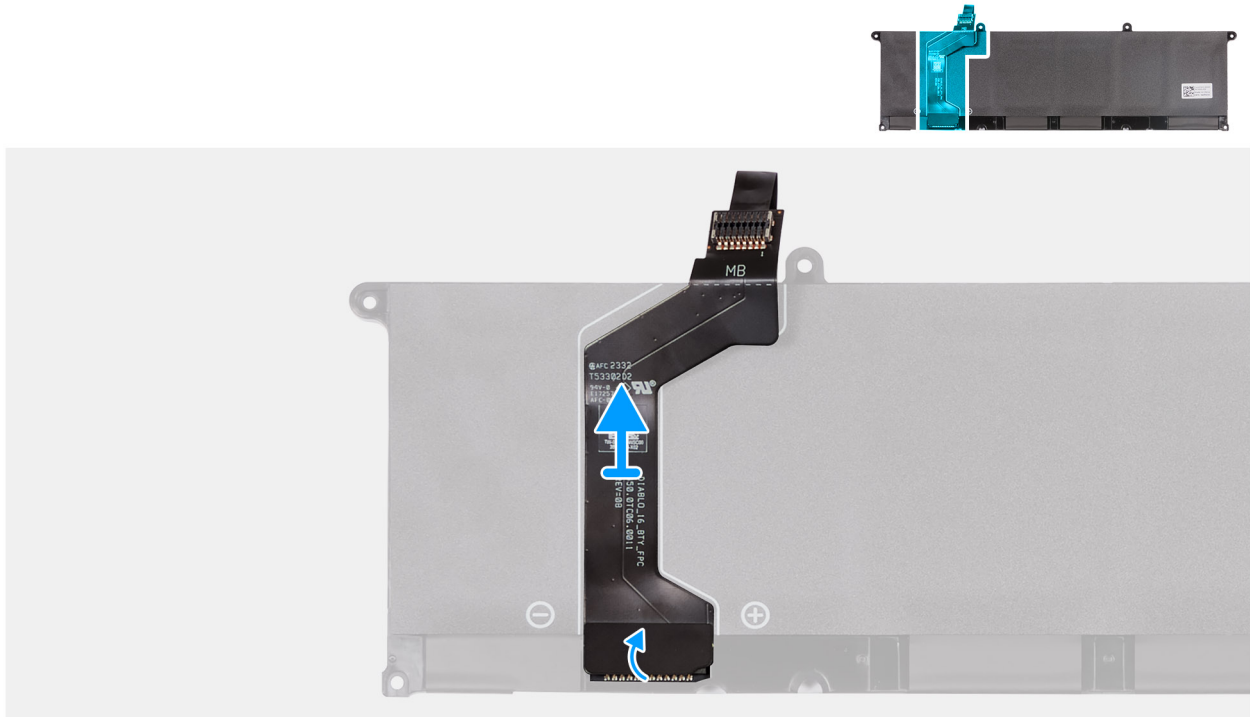

Figure 21. Removing the battery cable

### Steps

1. Turn the battery over.
2. Peel the battery cable from the battery until you reach the end where it connects the cable to the battery.
3. Grasp the battery cable near the connector and lift to disconnect it from the battery.

## Installing the battery cable

**CAUTION:** The information in this installation section is intended for authorized service technicians only.

### Prerequisites

If you are replacing a component, remove the existing component before performing the installation process.

### About this task

The following image(s) indicate the location of the battery cable and provides a visual representation of the installation procedure.





3x  
M2x4.5

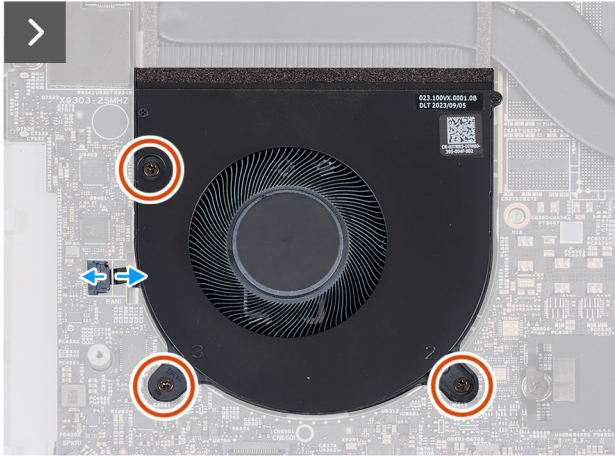
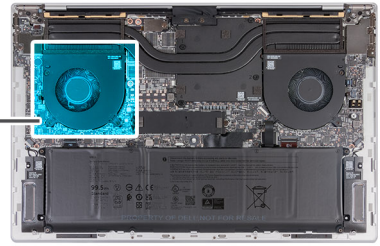
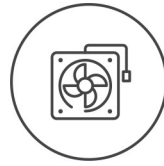

Figure 23. Removing the GPU fan

#### Steps

1. Remove the three screws (M2x4.5) that secure the fan to the system board and palm rest and keyboard assembly.

 **CAUTION:** Do not hold the fan assembly at the center, as it may damage the center bearing.

2. Open the latch and disconnect the fan cable from the connector (FAN1) on the system board.
3. Lift the fan off the palm rest and keyboard assembly.

## Installing the GPU fan

 **CAUTION:** The information in this removal section is intended for authorized service technicians only.

#### Prerequisites

#### About this task

The following image indicates the location of the GPU fan and provides a visual representation of the installation procedure.

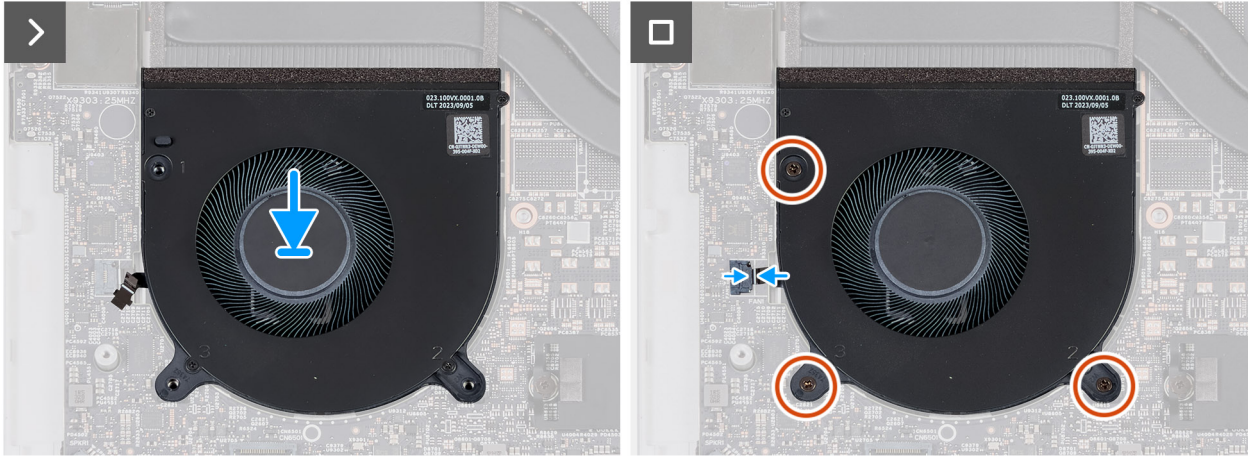
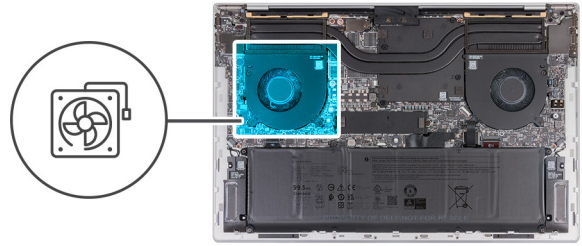

Figure 24. Installing the GPU fan

#### Steps

1. Align the screw holes on the fan with the screw holes on the system board and palm rest and keyboard assembly.
2. Replace the three screws (M2x4.5) that secure the fan to the system board and palm rest and keyboard assembly.
3. Connect the fan cable to the connector (FAN1) on the system board then close the latch.

#### Next steps

1. Install the [base cover](#).
2. Follow the procedure in [After working inside your computer](#).

## Removing the CPU fan

 **CAUTION:** The information in this removal section is intended for authorized service technicians only.

#### Prerequisites

1. Follow the procedure in [Before working inside your computer](#).
2. Remove the [base cover](#).

#### About this task

The following image indicates the location of the CPU fan and provides a visual representation of the removal procedure.





3x  
M2x4.5

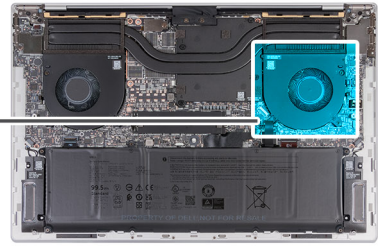
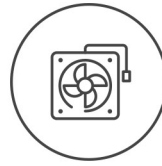



Figure 25. Removing the CPU fan

### Steps

1. Remove the three screws (M2x4.5) that secure the fan to the system board and palm rest and keyboard assembly.

 **CAUTION:** Do not hold the fan assembly at the center, as it may damage the center bearing.

2. Open the latch and disconnect the fan cable from the connector (FAN2) on the system board.
3. Lift the fan off the palm rest and keyboard assembly.

## Installing the CPU fan

 **CAUTION:** The information in this removal section is intended for authorized service technicians only.

### Prerequisites

### About this task

The following images indicate the location of the CPU fan and provides a visual representation of the installation procedure.



3x  
M2x4.5

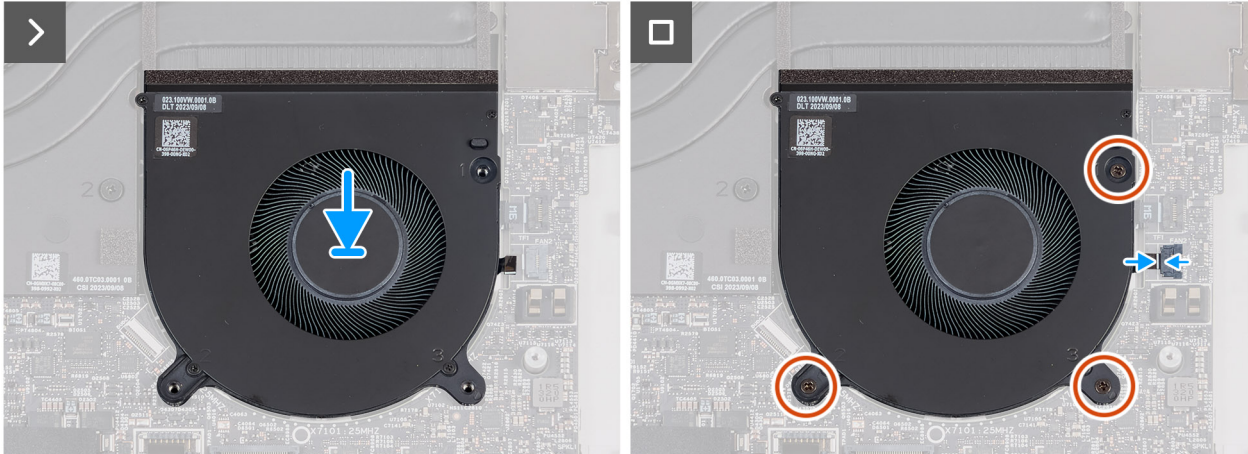
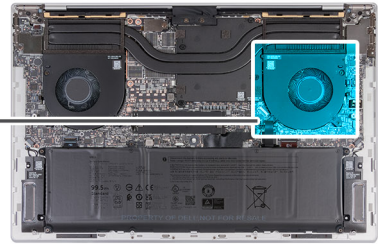
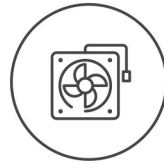

Figure 26. Installing the CPU fan

#### Steps

1. Align the screw holes on the fan with the screw holes on the system board and palm rest and keyboard assembly.
2. Replace the three screws (M2x4.5) that secure the fan to the system board and palm rest and keyboard assembly.
3. Connect the fan cable to the connector (FAN1) on the system board and close the latch.

#### Next steps

1. Install the [base cover](#).
2. Follow the procedure in [After working inside your computer](#).

## Solid-state drive

### Removing the solid-state drive

 **CAUTION:** The information in this removal section is intended for authorized service technicians only.

#### Prerequisites

1. Follow the procedure in [Before working inside your computer](#).
2. Remove the [base cover](#).

#### About this task

The following image(s) indicate the location of the solid-state drive and provides a visual representation of the removal procedure.



2x  
M2x3

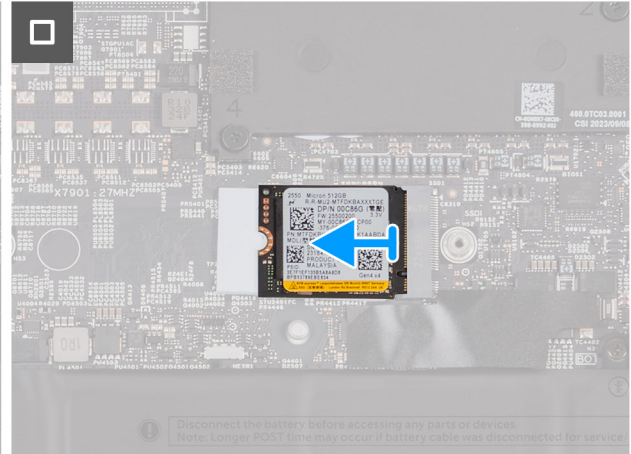
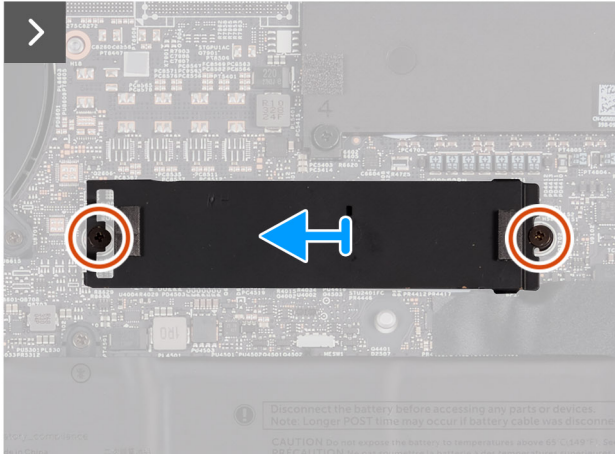
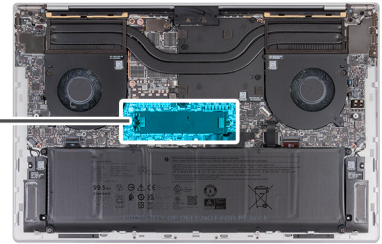

Figure 27. Removing the M.2 2230 solid-state drive



2x  
M2x3

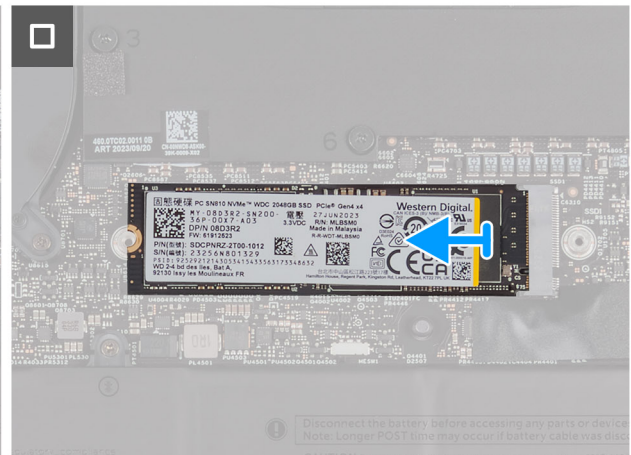
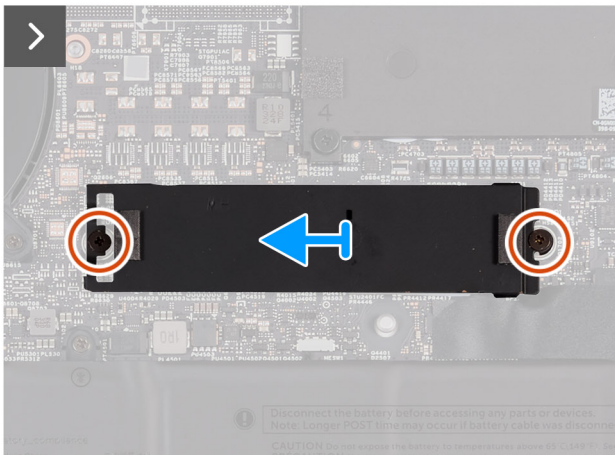
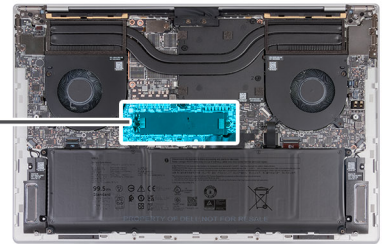

Figure 28. Removing the M.2 2280 solid-state drive

### Steps

1. Remove the two screws (M2x3) that secure the thermal shield to the system board.
2. Lift the thermal shield off the solid-state drive.
3. Slide and lift the solid state drive from the solid-state drive slot (SSD1) on the system board.

# Installing the solid-state drive

**CAUTION:** The information in this removal section is intended for authorized service technicians only.

## Prerequisites

If you are replacing a component, remove the existing component before performing the installation process.

## About this task

The following image(s) indicate the location of the solid-state drive slot and provides a visual representation of the installation procedure.

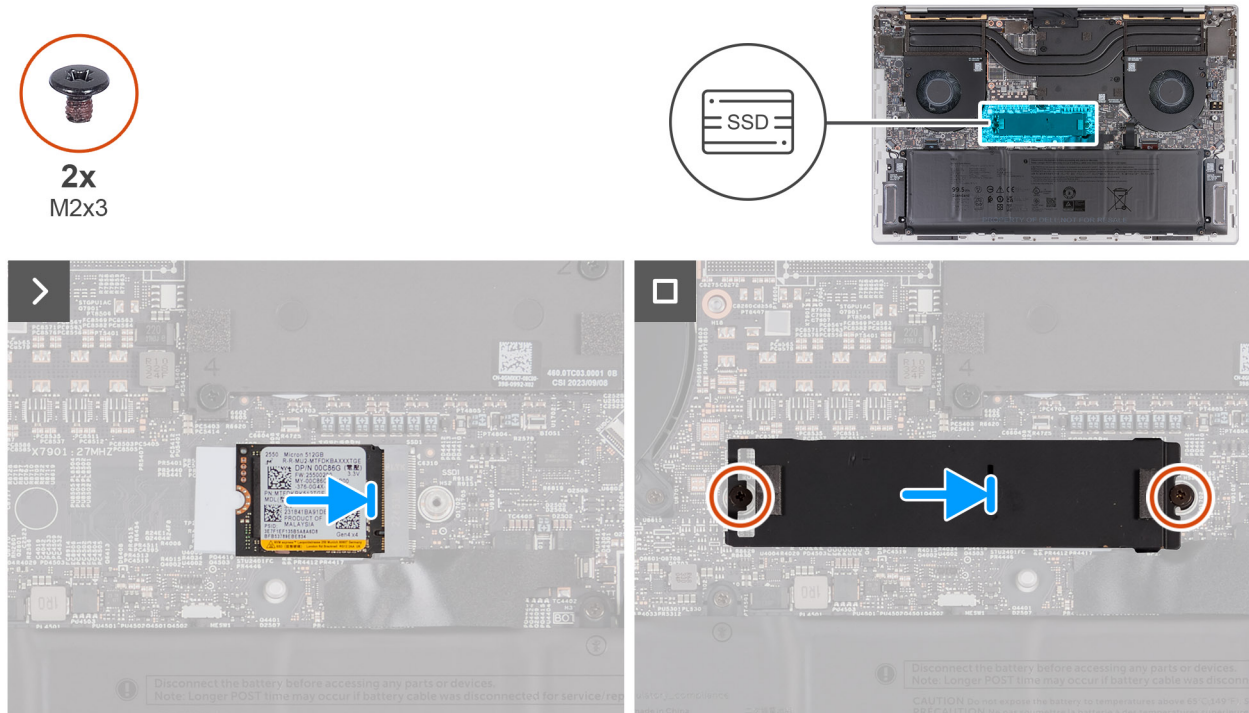

Figure 29. Installing the M.2 2230 solid-state drive



2x  
M2x3

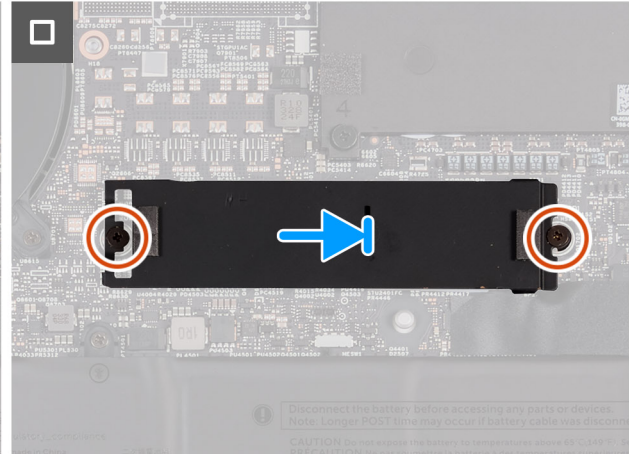
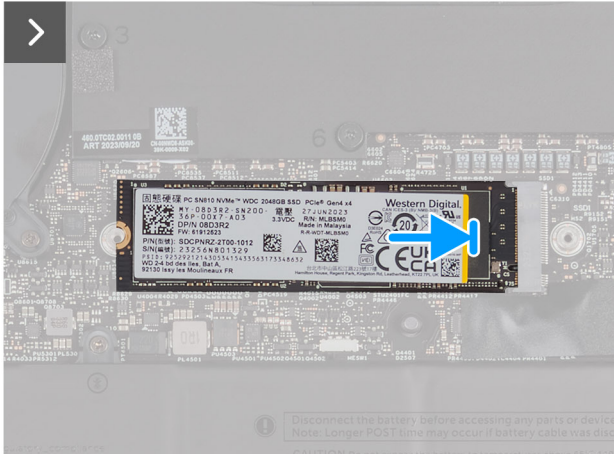
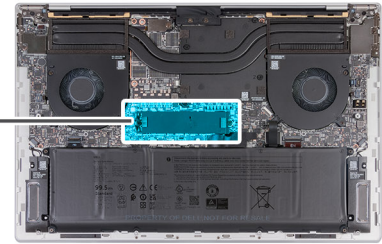
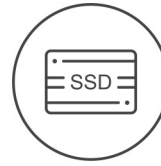

Figure 30. Installing the M.2 2280 solid-state drive

#### Steps

1. Align the notch on the solid-state drive with the tab on the solid-state drive slot (SSD1) on the system board.
2. Slide the solid-state drive into the solid-state drive slot (SSD1) on the system board.
3. Align the screw holes on the thermal shield with the screw holes on the system board.
4. Replace the two screws (M2x3) that secure the thermal shield to the system board.

#### Next steps

1. Install the [base cover](#).
2. Follow the procedure in [After working inside your computer](#).

## Heat sink

### Removing the heat sink—Integrated GPUs

**CAUTION:** The information in this removal section is intended for authorized service technicians only.

#### Prerequisites

1. Follow the procedure in [Before working inside your computer](#).
2. Remove the [base cover](#).

#### About this task

**CAUTION:** The heat sink may become hot during normal operation. Allow sufficient time for the heat sink to cool before you touch it.

**NOTE:** For maximum cooling of the processor, do not touch the heat transfer areas on the heat sink. The oils in your skin can reduce the heat transfer capability of the thermal grease.

The following image(s) indicate the location of the heat sink on computers that are shipped with integrated GPUs and provides a visual representation of the removal procedure.

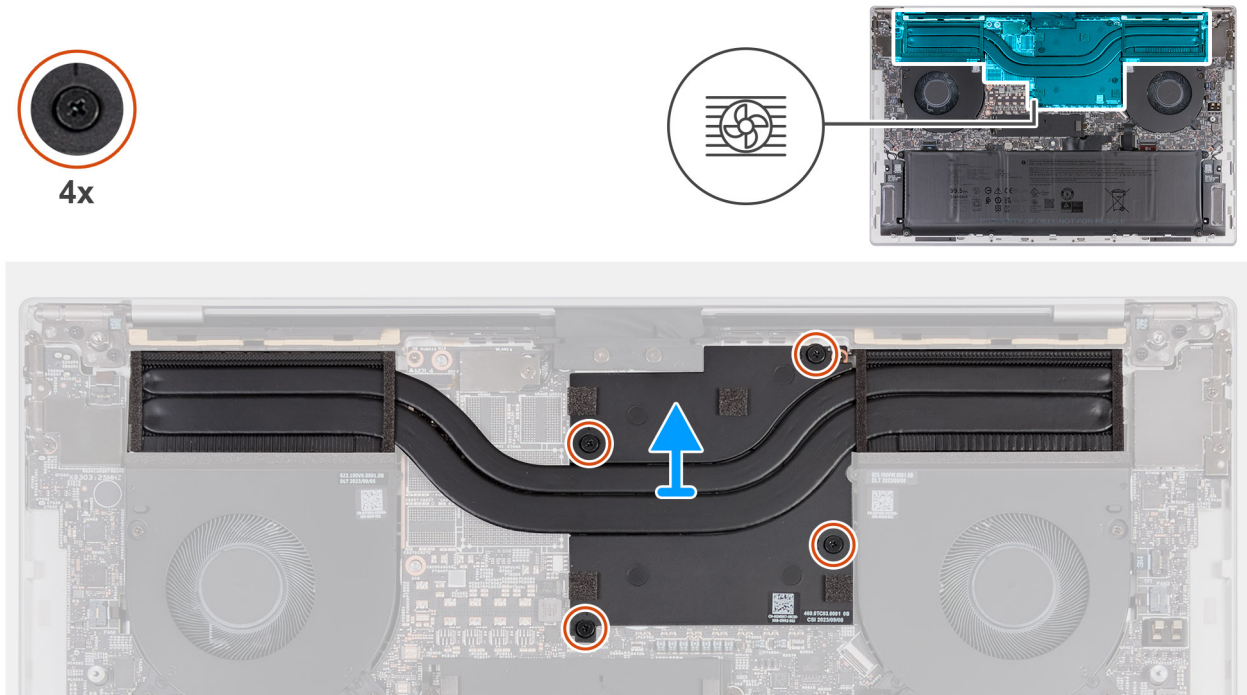

**Figure 31. Removing the heat sink—Integrated GPUs**

#### Steps

1. In reverse sequential order (4>3>2>1), loosen the four captive screws that secure the heat sink to the system board.
2. Lift the heat sink off the system board.

## Installing the heat sink—Integrated GPU

**CAUTION:** The information in this installation section is intended for authorized service technicians only.

#### Prerequisites

If you are replacing a component, remove the existing component before performing the installation process.

#### About this task

The following image(s) indicate the location of the heat sink on computers that are shipped with integrated GPUs and provides a visual representation of the installation procedure.

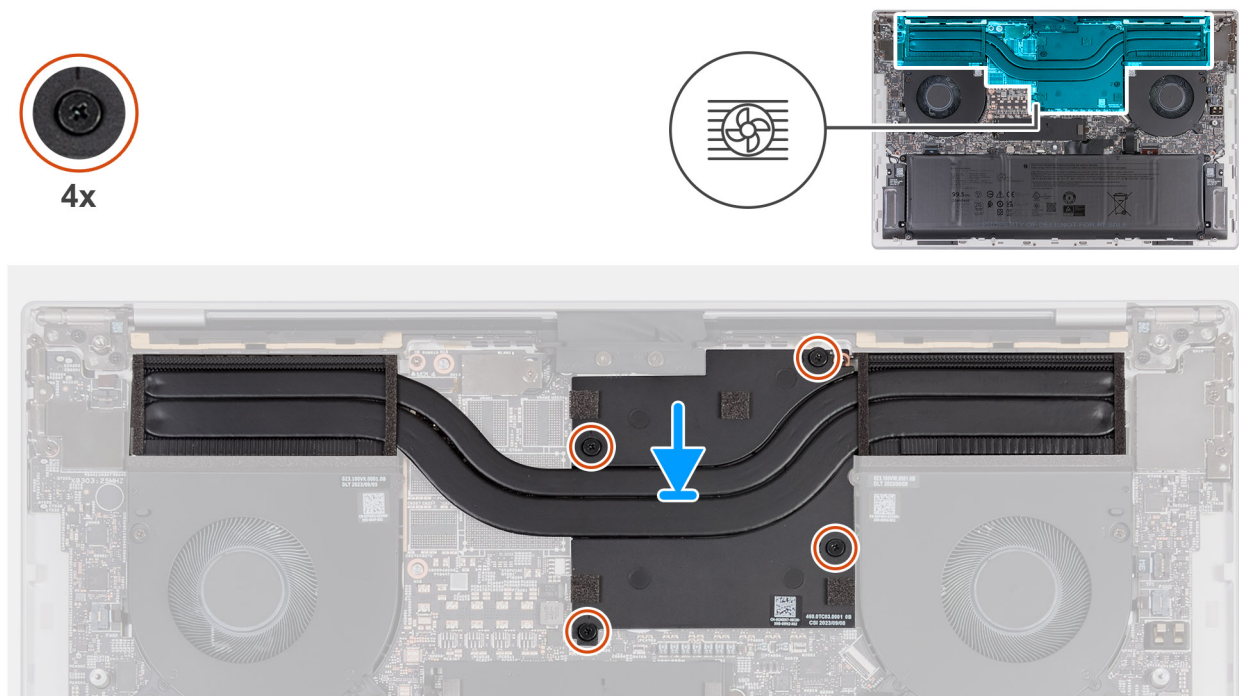

**Figure 32. Installing the heat sink—Integrated GPU**

#### Steps

1. Align the screw holes on the heat sink with the screw holes on the system board.
2. In sequential order (1>2>3>4), tighten the four captive screws that secure the heat sink to the system board.

#### Next steps

1. Install the [base cover](#).
2. Follow the procedure in [After working inside your computer](#).

## Removing the heat sink—Discrete GPU

**CAUTION:** The information in this removal section is intended for authorized service technicians only.

#### Prerequisites

1. Follow the procedure in [Before working inside your computer](#).
2. Remove the [base cover](#).

#### About this task

**CAUTION:** The heat sink may become hot during normal operation. Allow sufficient time for the heat sink to cool before you touch it.

**NOTE:** For maximum cooling of the processor, do not touch the heat-transfer areas on the heat sink. The oils in your skin can reduce the heat-transfer capability of the thermal grease.

The following images indicate the location of the heat sink on computers that are shipped with discrete GPUs and provides a visual representation of the removal procedure.

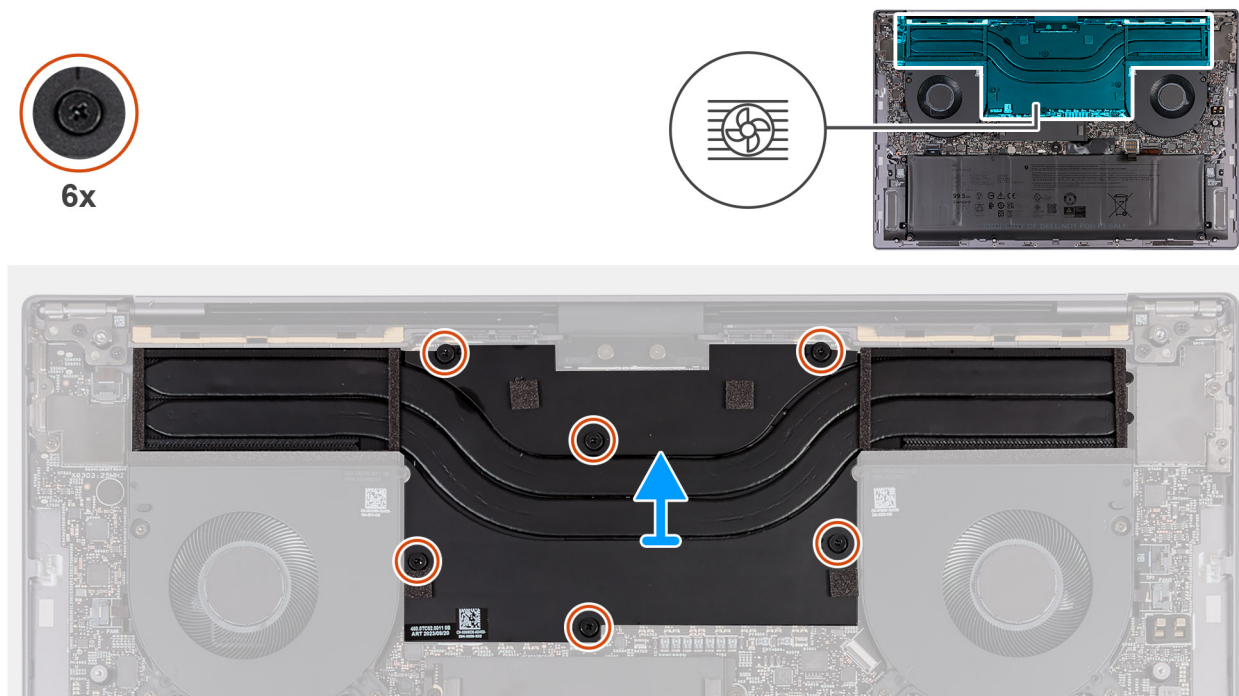

**Figure 33. Removing the heat sink—Discrete GPU (non-Vapor Chamber)**

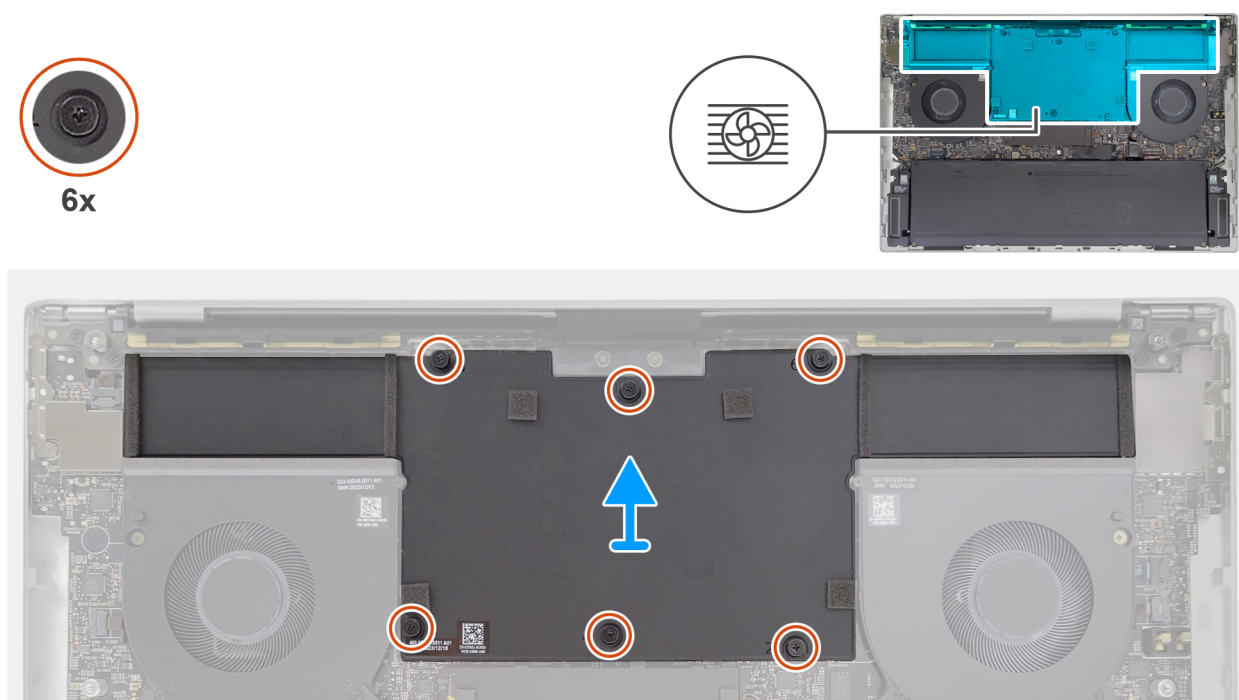

**Figure 34. Removing the heat sink—Discrete GPU (Vapor Chamber)**

**Steps**

1. In reverse sequential order (6>5>4>3>2>1), loosen the six captive screws that secure the heat sink to the system board.
2. Lift the heat sink off the system board.



## Installing the heat sink—Discrete GPU

**CAUTION:** The information in this installation section is intended for authorized service technicians only.

### Prerequisites

If you are replacing a component, remove the existing component before performing the installation process.

### About this task

The following images indicate the location of the heat sink on computers that are shipped with discrete GPUs and provides a visual representation of the installation procedure.

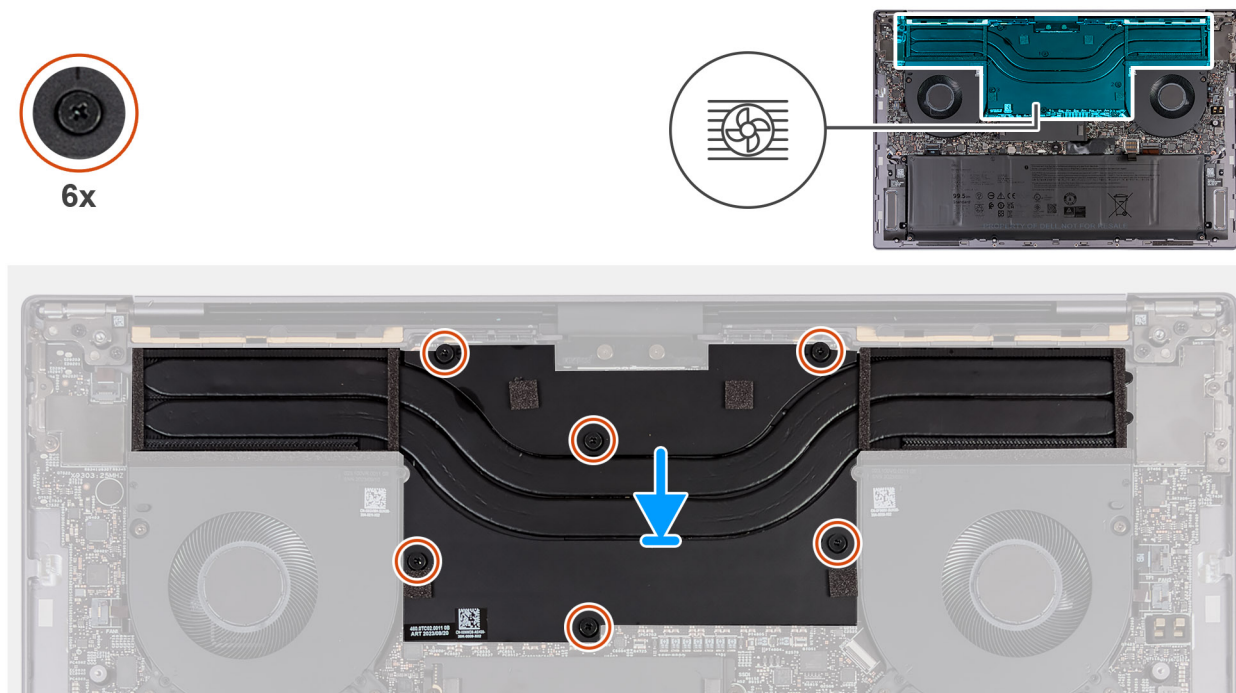
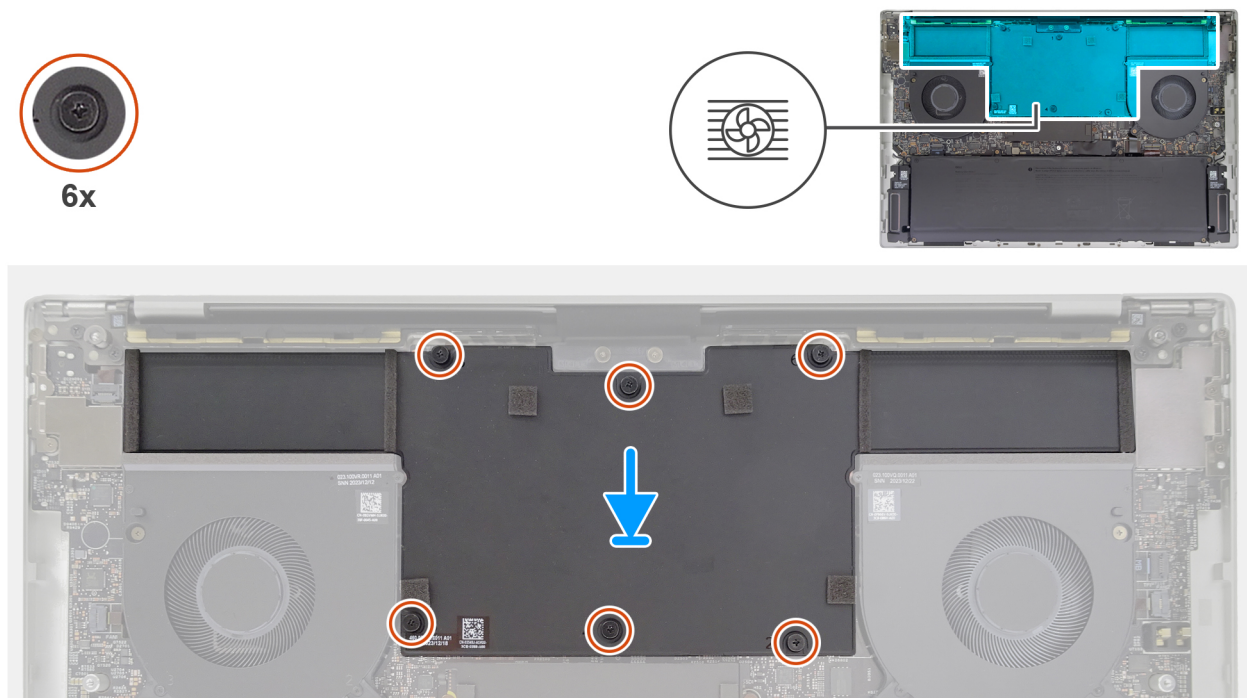

Figure 35. Installing the heat sink—Discrete GPU (non-Vapor Chamber)



**Figure 36. Installing the heat sink—Discrete GPU (Vapor Chamber)**

**Steps**

1. Align the screw holes on the fan and heat sink with the screw holes on the system board.
2. In sequential order (1>2>3>4>5>6), tighten the six captive screws that secure the heat sink to the system board.

**Next steps**

1. Install the [base cover](#).
2. Follow the procedure in [After working inside your computer](#).

## Wireless-module shield

### Removing the wireless-module shield

**CAUTION:** The information in this removal section is intended for authorized service technicians only.

**Prerequisites**

1. Follow the procedure in [Before working inside your computer](#).
2. Remove the [base cover](#).

**About this task**

The following image indicates the location of the wireless-module shield and provides a visual representation of the removal procedure.



1x  
M2x3

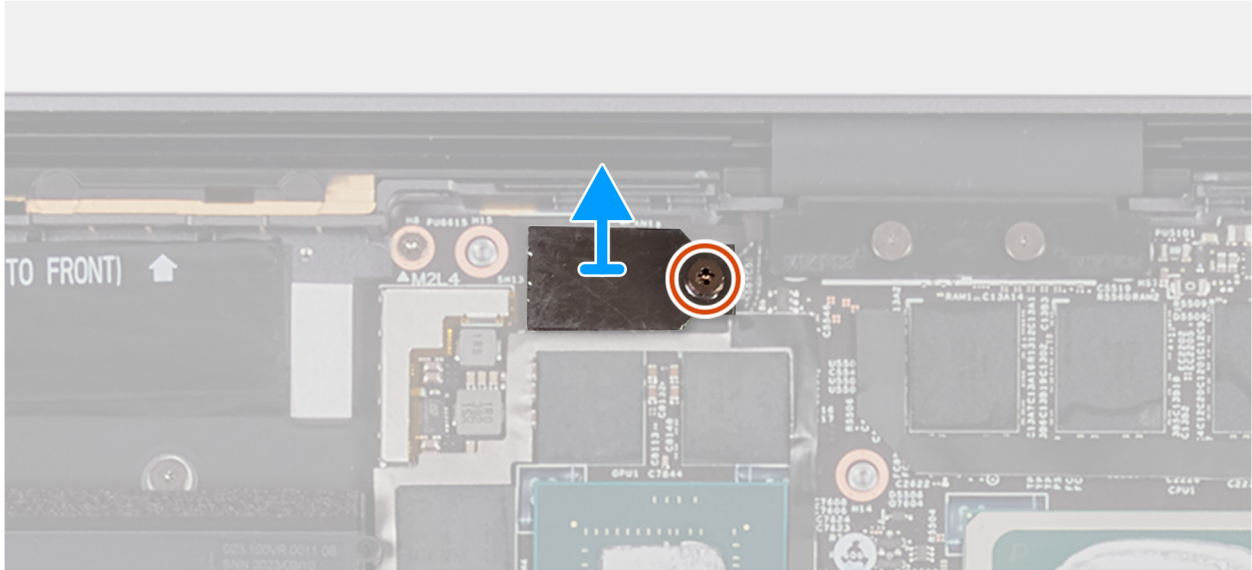
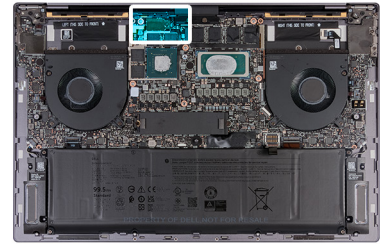

Figure 37. Removing the wireless-module shield

#### Steps

1. Remove the screw (M2x3) that secures the wireless-module shield to the system board.
2. Lift the wireless-module shield off the system board.

## Installing the wireless-module shield

**CAUTION:** The information in this removal section is intended for authorized service technicians only.

#### Prerequisites

#### About this task

The following image indicates the location of the wireless-module shield and provides a visual representation of the installation procedure.



1x  
M2x3

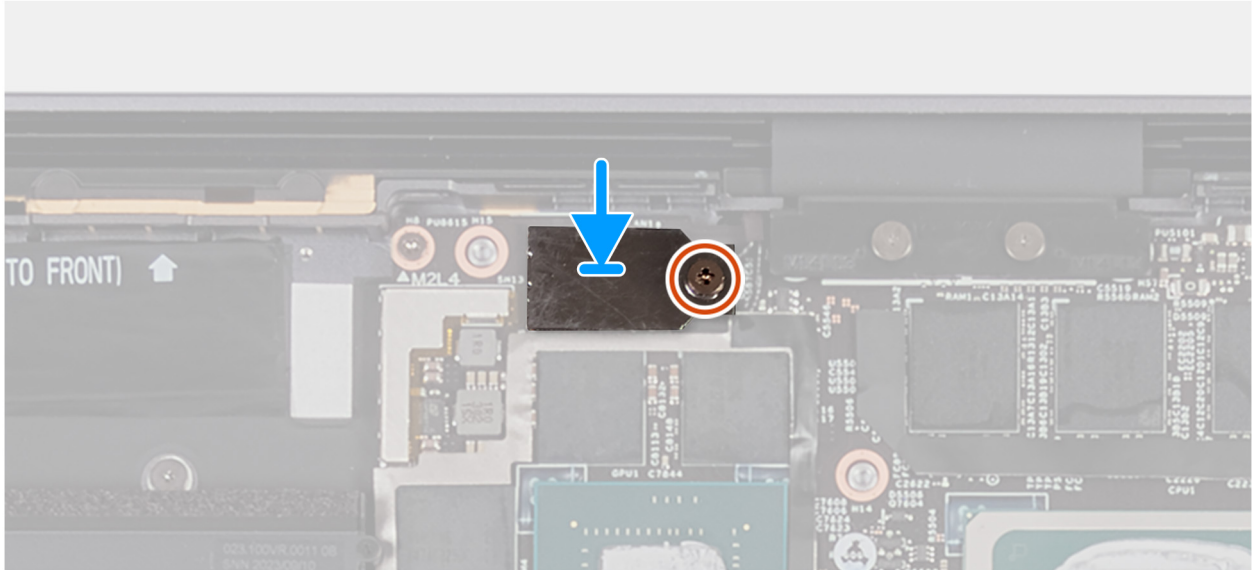
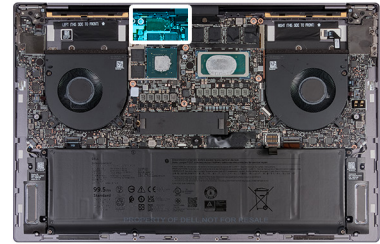

Figure 38. Installing the wireless-module shield

#### Steps

1. Align the screw hole on the wireless-module shield with the screw hole on the system board.
2. Replace the screw (M2x3) that secures the wireless-module shield to the system board.

#### Next steps

1. Install the [base cover](#).
2. Follow the procedure in [After working inside your computer](#).

## Display assembly

### Removing the display assembly

 **CAUTION:** The information in this removal section is intended for authorized service technicians only.

#### Prerequisites

1. Follow the procedure in [Before working inside your computer](#).
2. Remove the [base cover](#).

#### About this task

The following image(s) indicate the location of the display assembly and provides a visual representation of the removal procedure.

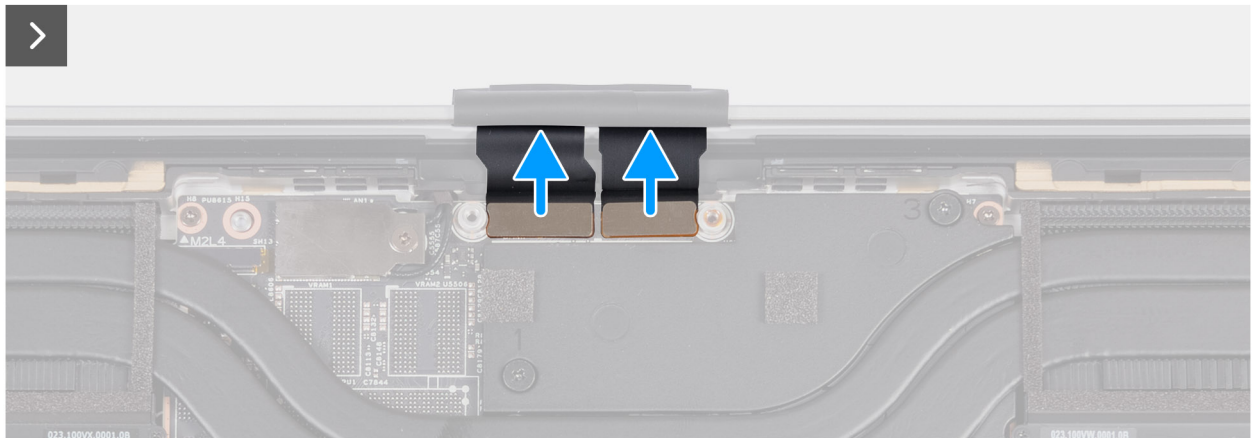
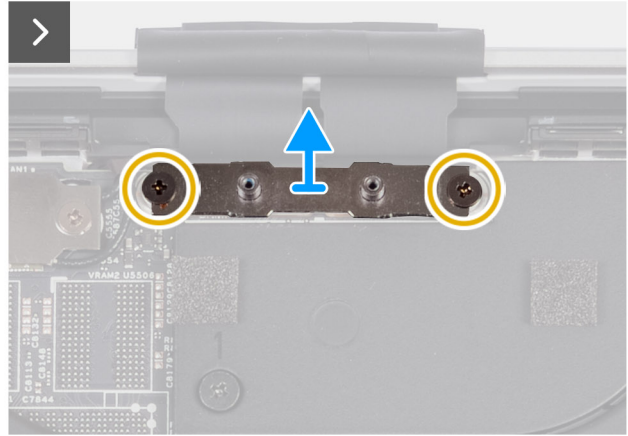
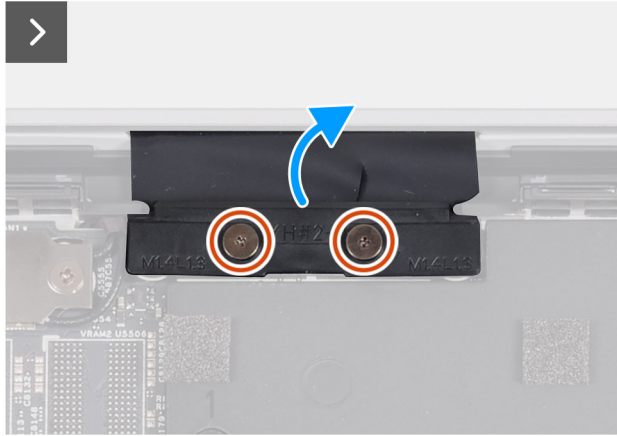
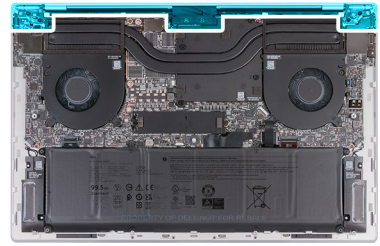
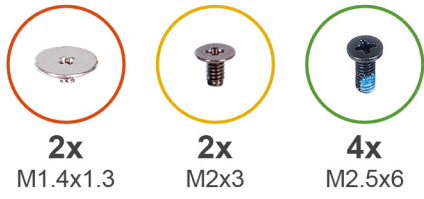

Figure 39. Removing the display assembly



**Figure 40. Removing the display assembly**

**Steps**

1. Remove the two screws (M1.4x1.3) that secure the display-cable cover to the display-cable connector bracket.
2. Remove the two screws (M2x3) that secure the display-cable connector bracket to the system board.
3. Lift the bracket off the system board.
4. Disconnect the two display cables from the connectors (CAM1) on the system board.
5. Open the palm rest and keyboard assembly at an angle and remove the display assembly.
6. Remove the two screws (M2.5x6) that secure the left-display hinge to the palm rest and keyboard assembly and open the left hinge.
7. Remove the two screws (M2.5x6) that secure the right-display hinge to the palm rest and keyboard assembly and open the right hinge.
8. After performing all the above steps, you are left with the display assembly.



Figure 41. Display assembly

## Installing the display assembly

**CAUTION:** The information in this installation section is intended for authorized service technicians only.

### Prerequisites

If you are replacing a component, remove the existing component before performing the installation process.

### About this task

The following image(s) indicate the location of the display assembly and provides a visual representation of the installation procedure.

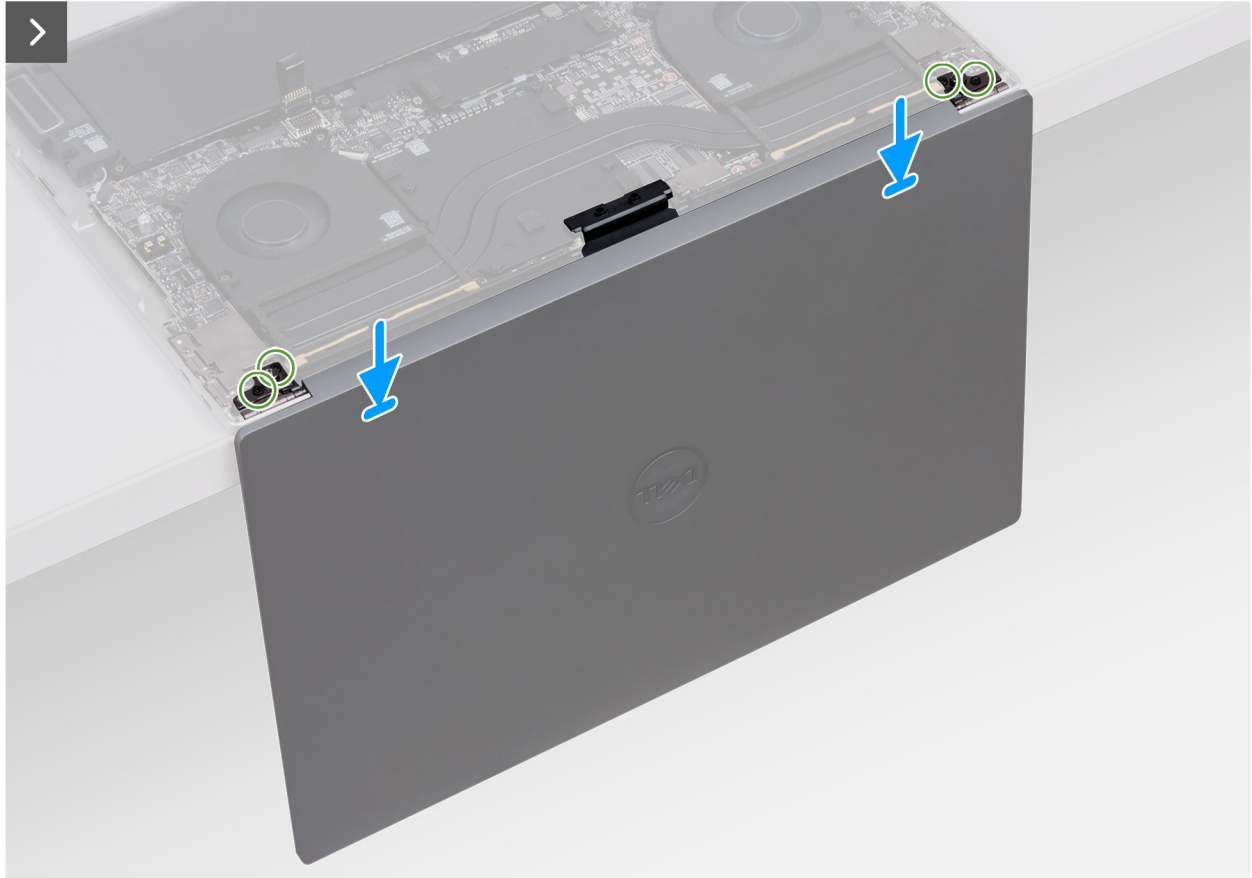
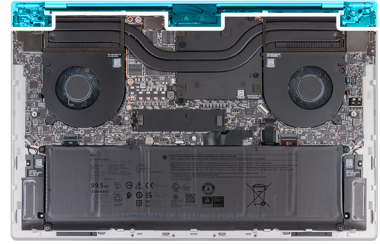
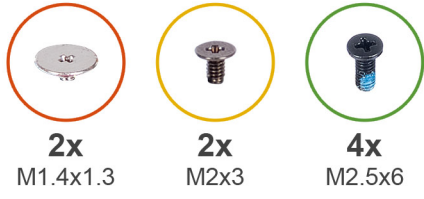
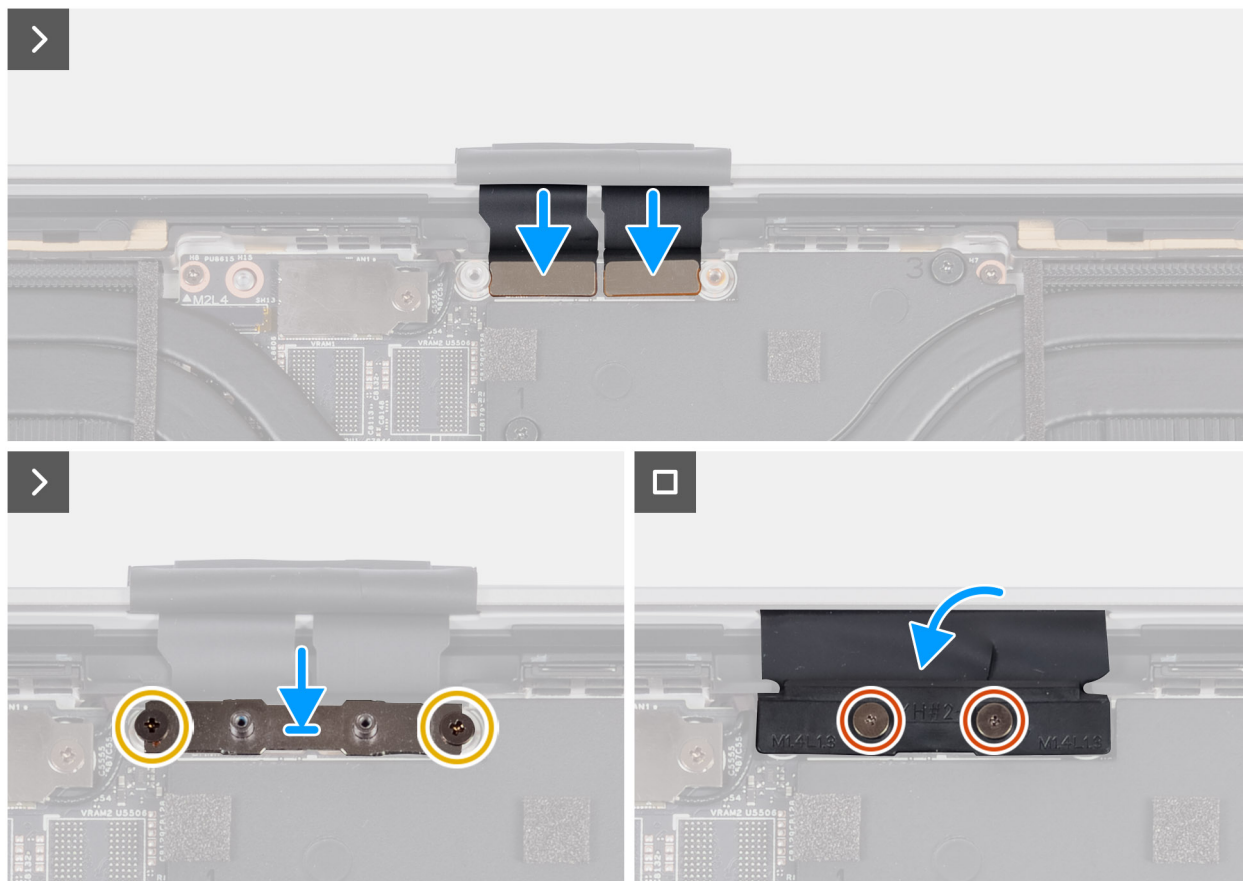

Figure 42. Installing the display assembly





**Figure 43. Installing the display assembly**

#### Steps

1. Place the palm-rest assembly at the edge of a flat table.

**CAUTION:** To avoid damaging the display, do not slide palm rest and keyboard assembly on the display assembly.

2. Align the screw holes of the palm-rest assembly with the screw holes on the hinges of the display assembly.
3. Replace the two screws (M2.5x6) that secure the right-display hinge to the palm rest and keyboard assembly and open the right hinge.
4. Replace the two screws (M2.5x6) that secure the left-display hinge to the palm rest and keyboard assembly and open the left hinge.
5. Align the screw holes on the display-cable connector bracket with the screw holes on the system board.
6. Replace the two screws (M2x3) that secure the display-cable connector bracket to the system board.
7. Replace the two screws (M1.4x1.3) that secure the display-cable cover to the display-cable connector bracket.

#### Next steps

1. Install the [base cover](#).
2. Follow the procedure in [After working inside your computer](#).

## Type-C bracket

### Removing the Type-C brackets

**CAUTION:** The information in this removal section is intended for authorized service technicians only.

### Prerequisites

1. Follow the procedure in [Before working inside your computer](#).
2. Remove the [base cover](#).

### About this task

The following image(s) indicate the location of the Type-C bracket and provides a visual representation of the removal procedure.



**5x**  
M2x4.5

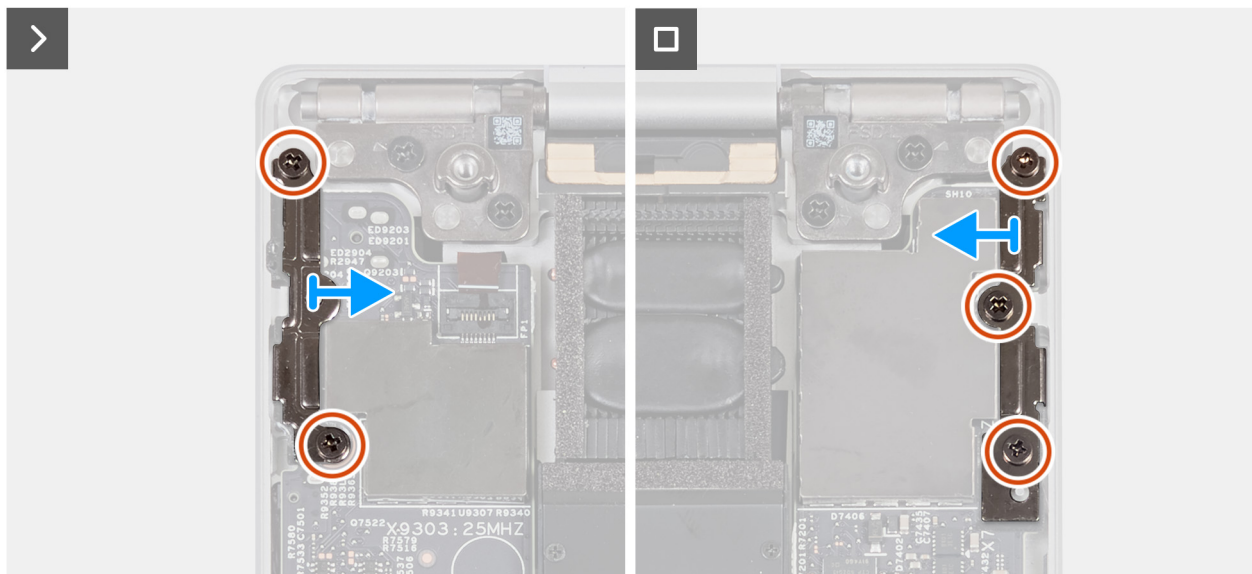
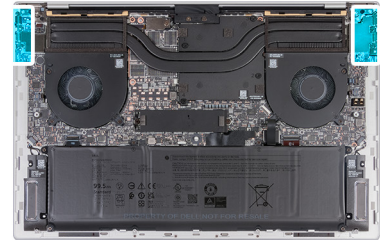

**Figure 44. Removing the Type-C brackets**

### Steps

1. Remove the two screws (M2x4.5) that secure the right Type-C bracket to the system board.
2. Remove the three screws (M2x4.5) that secure the left Type-C bracket to the palm rest and keyboard assembly and system board.
3. Lift the Type-C brackets off from the palm rest and keyboard assembly.

## Installing the Type-C brackets

**CAUTION:** The information in this installation section is intended for authorized service technicians only.

### Prerequisites

If you are replacing a component, remove the existing component before performing the installation process.

### About this task

The following image(s) indicate the location of the Type-C bracket and provides a visual representation of the installation procedure.



5x  
M2x4.5

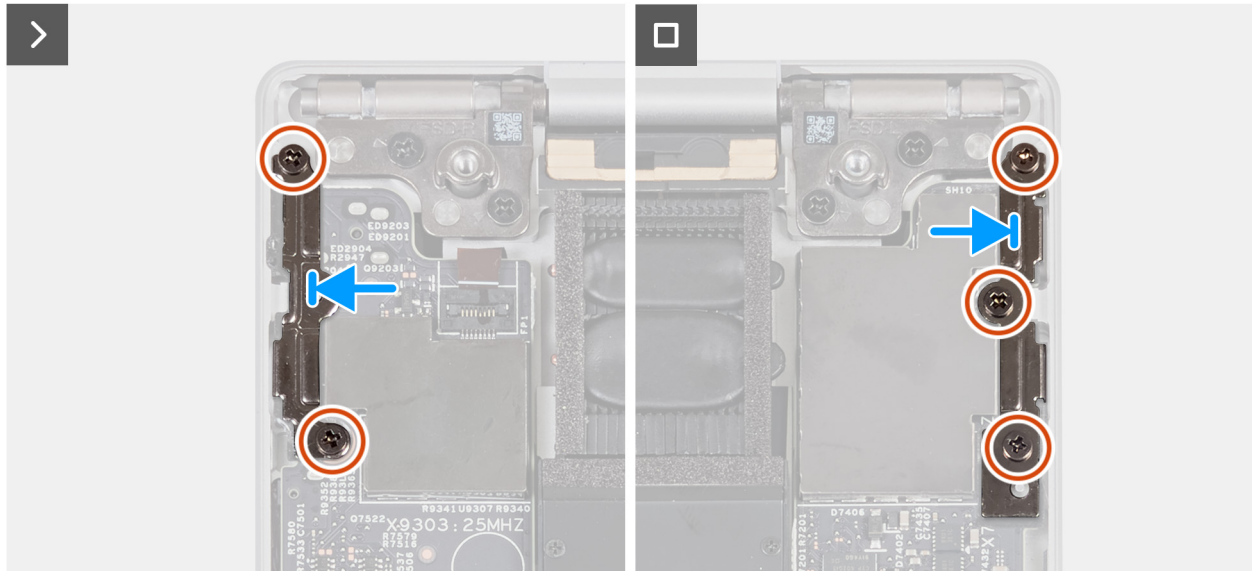
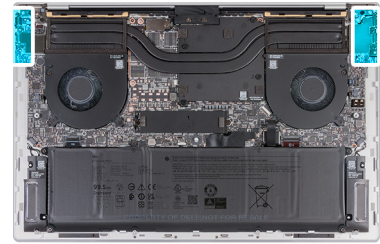

Figure 45. Installing the Type-C brackets

#### Steps

1. Align and the screw holes on the right Type-C bracket with the screw holes on the system board.
2. Replace the two screws (M2x4.5) that secure the right Type-C bracket to the system board.
3. Align and the screw holes on the left Type-C bracket with the screw holes on the palm rest and keyboard assembly and system board.
4. Replace the three screws (M2x4.5) that secure the left Type-C bracket to the palm rest and keyboard assembly and system board.

#### Next steps

1. Install the [base cover](#).
2. Follow the procedure in [After working inside your computer](#).

## System board

### Removing the system board

 **CAUTION:** The information in this removal section is intended for authorized service technicians only.

#### Prerequisites

1. Follow the procedure in [Before working inside your computer](#).
2. Remove the [base cover](#).
3. Remove the [battery](#).
4. Remove the [solid-state drive](#).
5. Remove the [fans](#).

6. Remove the [heat sink](#).
7. Remove the [Type-C brackets](#).

### About this task

The following image indicates the connectors on your system board.

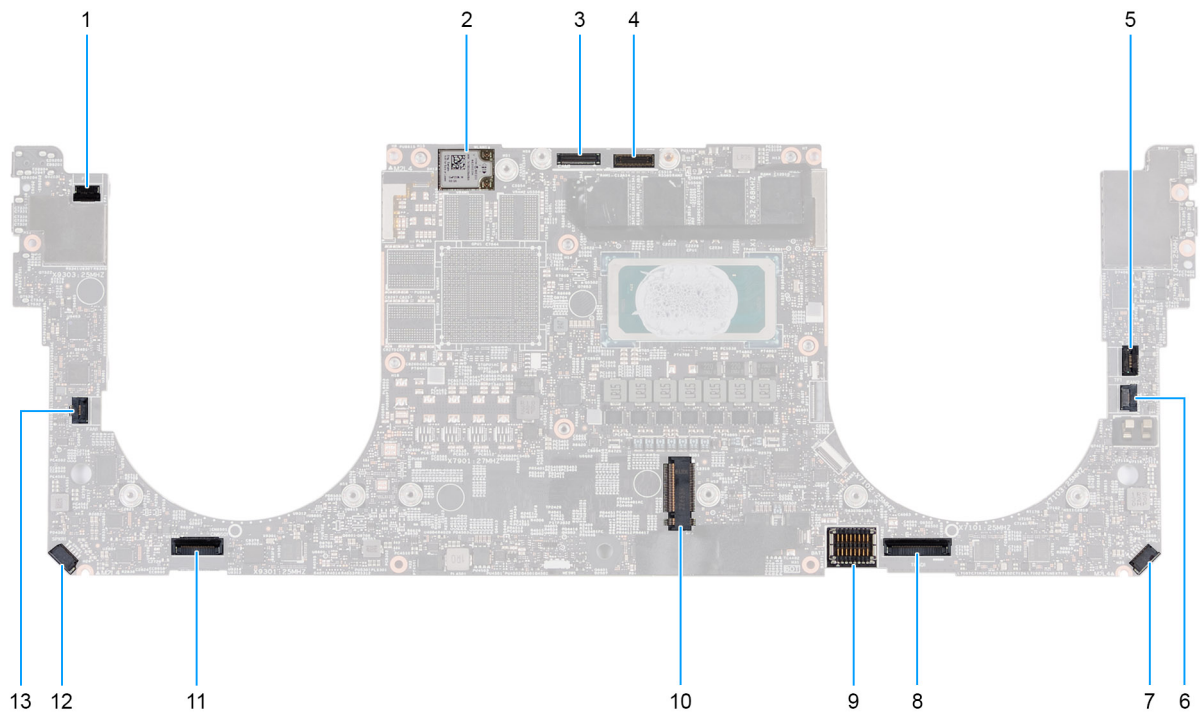

**Figure 46. System-board connectors**

1. Power-button and fingerprint reader cable connector (FP1)
2. Antenna-cable connectors (MAIN 2 and AUX 1) on wireless module
3. Camera-cable connector (CAM1)
4. Display assembly cable connector (LCD1)
5. Capacitive touch-panel cable connector (TF1)
6. CPU fan cable connector (FAN2)
7. Speaker (L) cable connector (SPKL1)
8. Touchpad-cable connector (TPAD1)
9. Battery-cable connector (BATT)
10. Solid-state drive slot (SSD1)
11. Keyboard-cable connector (CN6501)
12. Speaker (R) cable connector (SPKR1)
13. GPU fan cable connector (FAN1)

The following image(s) indicate the location of the system board and provides a visual representation of the removal procedure.

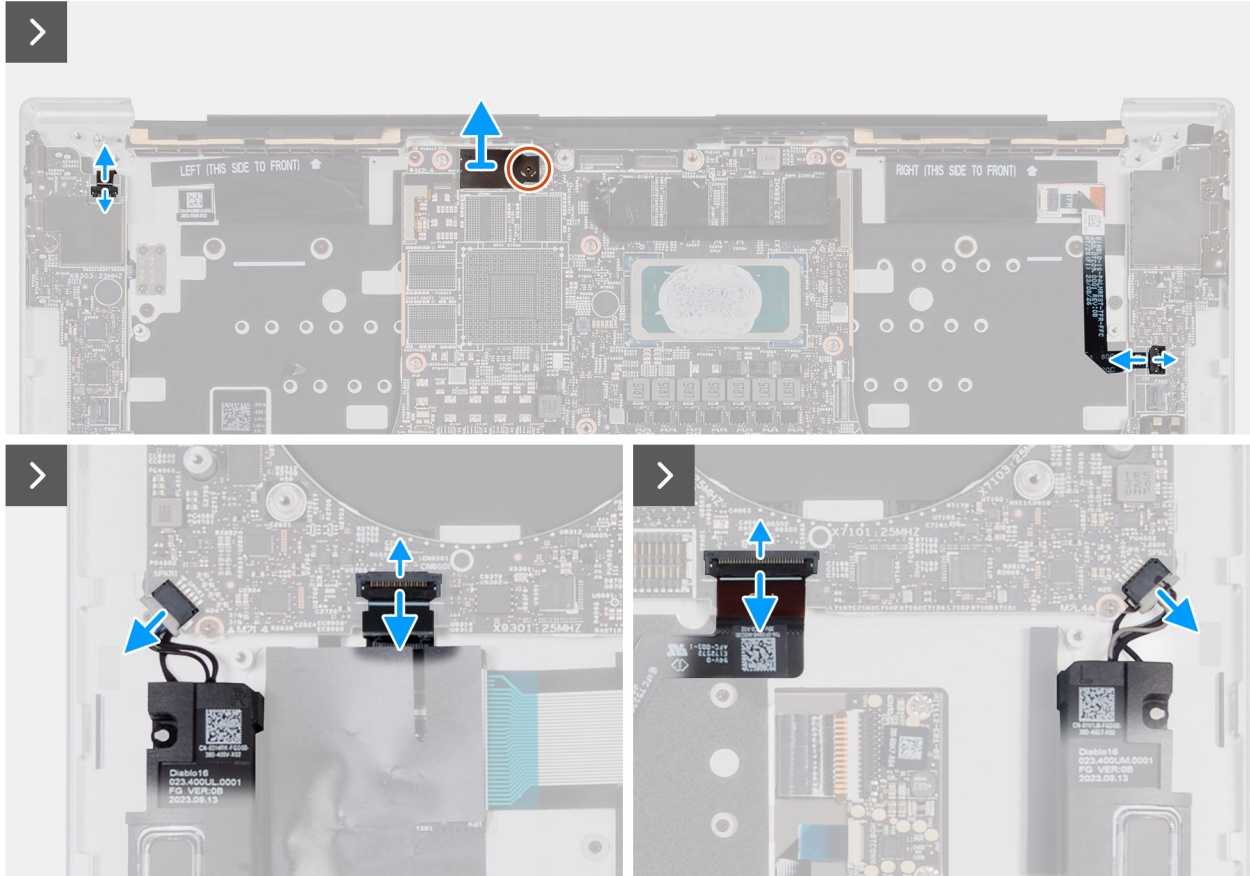
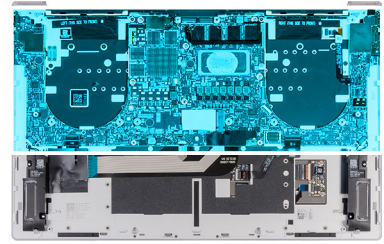

Figure 47. Removing the system board

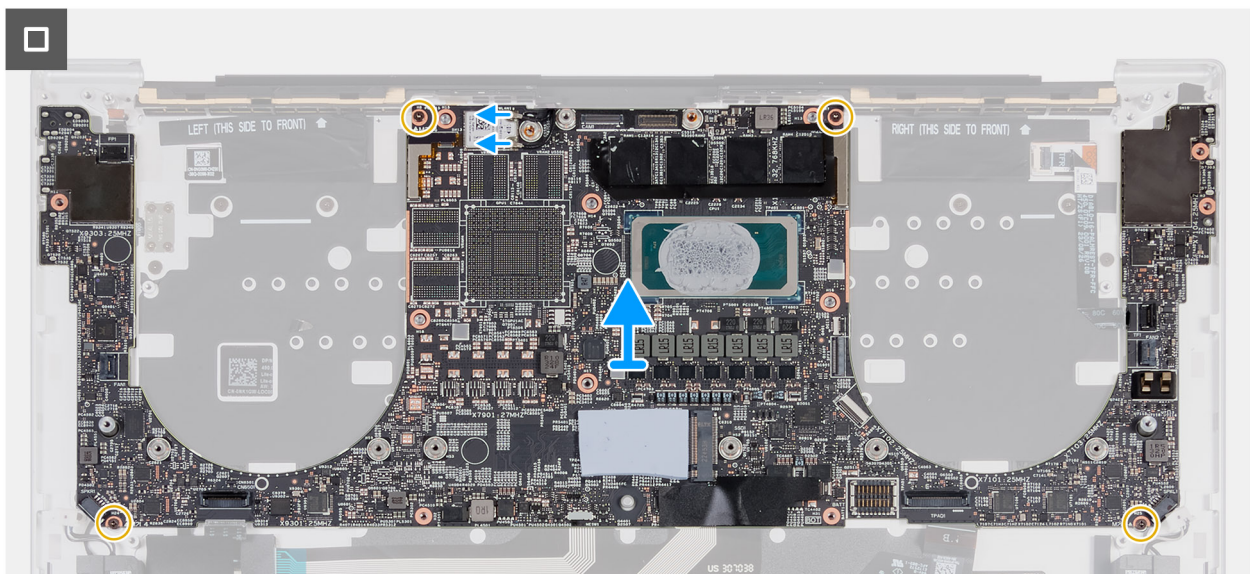

Figure 48. Removing the system board

## Steps

1. Open the latch and disconnect the power-button and fingerprint reader cable from the connector (FP1) on the system board.
2. Remove the screw (M2x3) that secures the wireless-module shield to the system board.
3. Open the latch and disconnect the capacitive touch-panel cable connector (TF1) on the system board.
4. Disconnect the speaker cable from the connector (SPKR1) on the system board.
5. Open the latch and disconnect the keyboard-controller cable from the connector (CN6501) on the system board.
6. Open the latch and disconnect the touchpad cable from the connector (TPAD1) on the system board.
7. Disconnect the speaker cable from the connector (SPKL1) on the system board.
8. Disconnect the antenna cables from the connectors (AUX1 and MAIN2) on the wireless module.
9. Remove the four screws (M2x4.5) that secure the system board to the palm rest and keyboard assembly.
10. Remove the system board from the palm rest and keyboard assembly.

## Installing the system board

**CAUTION:** The information in this installation section is intended for authorized service technicians only.

### Prerequisites

If you are replacing a component, remove the existing component before performing the installation process.

### About this task

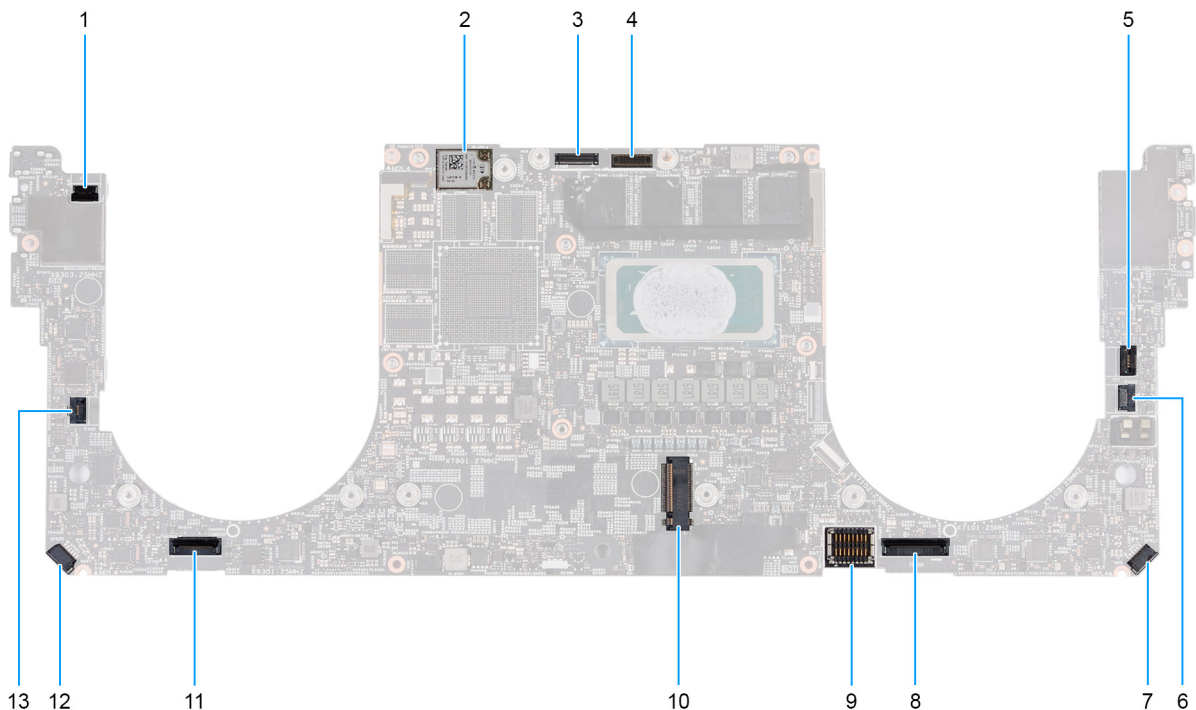
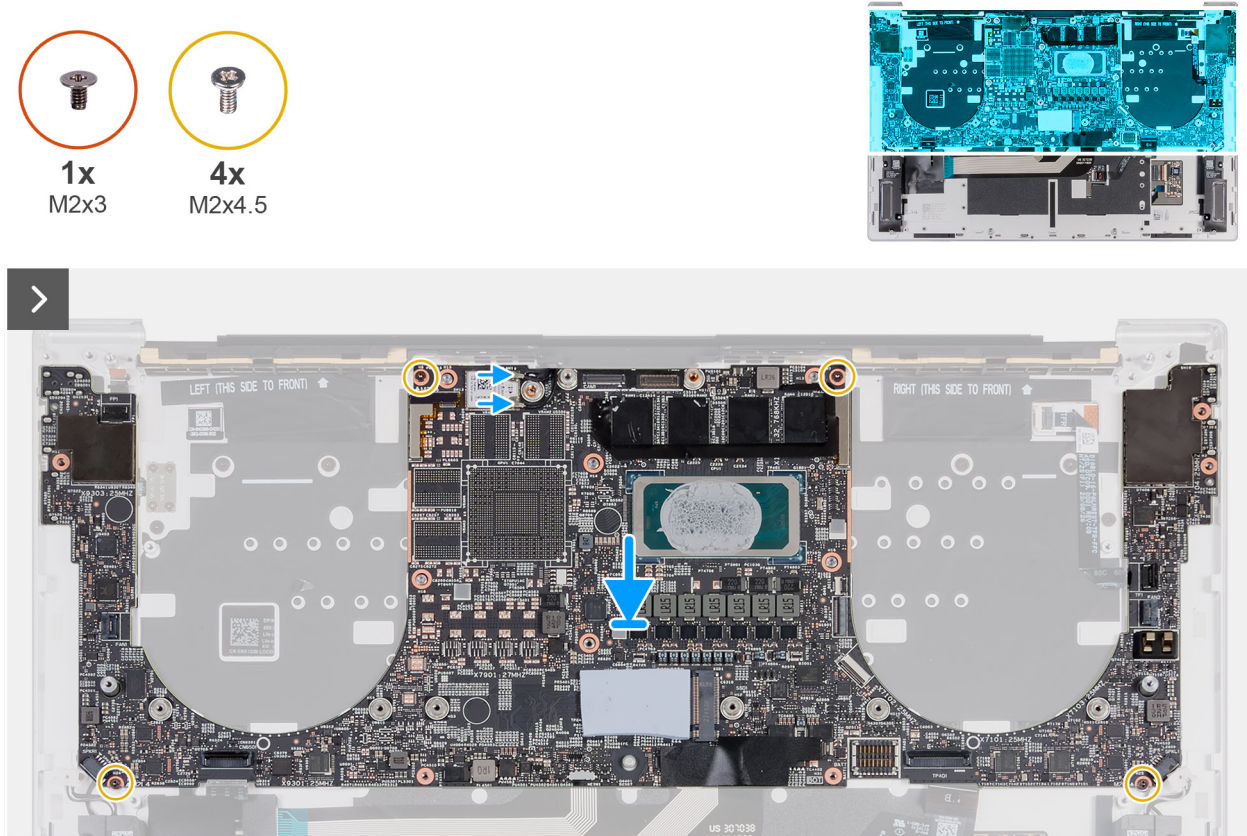

**Figure 49. System-board connectors**

1. Power-button and fingerprint reader cable connector (FP1)
2. Antenna-cable connectors (MAIN 2 and AUX 1) on wireless module
3. Camera-cable connector (CAM1)

4. Display assembly cable connector (LCD1)
5. Capacitive touch-panel cable connector (TF1)
6. CPU fan cable connector (FAN2)
7. Speaker (L) cable-connector (SPKL1)
8. Touchpad-cable connector (TPAD1)
9. Battery-cable connector (BATT)
10. Solid-state drive slot (SSD1)
11. Keyboard-cable connector (CN6501)
12. Speaker (R) cable connector (SPKR1)
13. GPU fan cable connector (FAN1)

The following image(s) indicate the location of the system board and provides a visual representation of the installation procedure.



**Figure 50. Installing the system board**

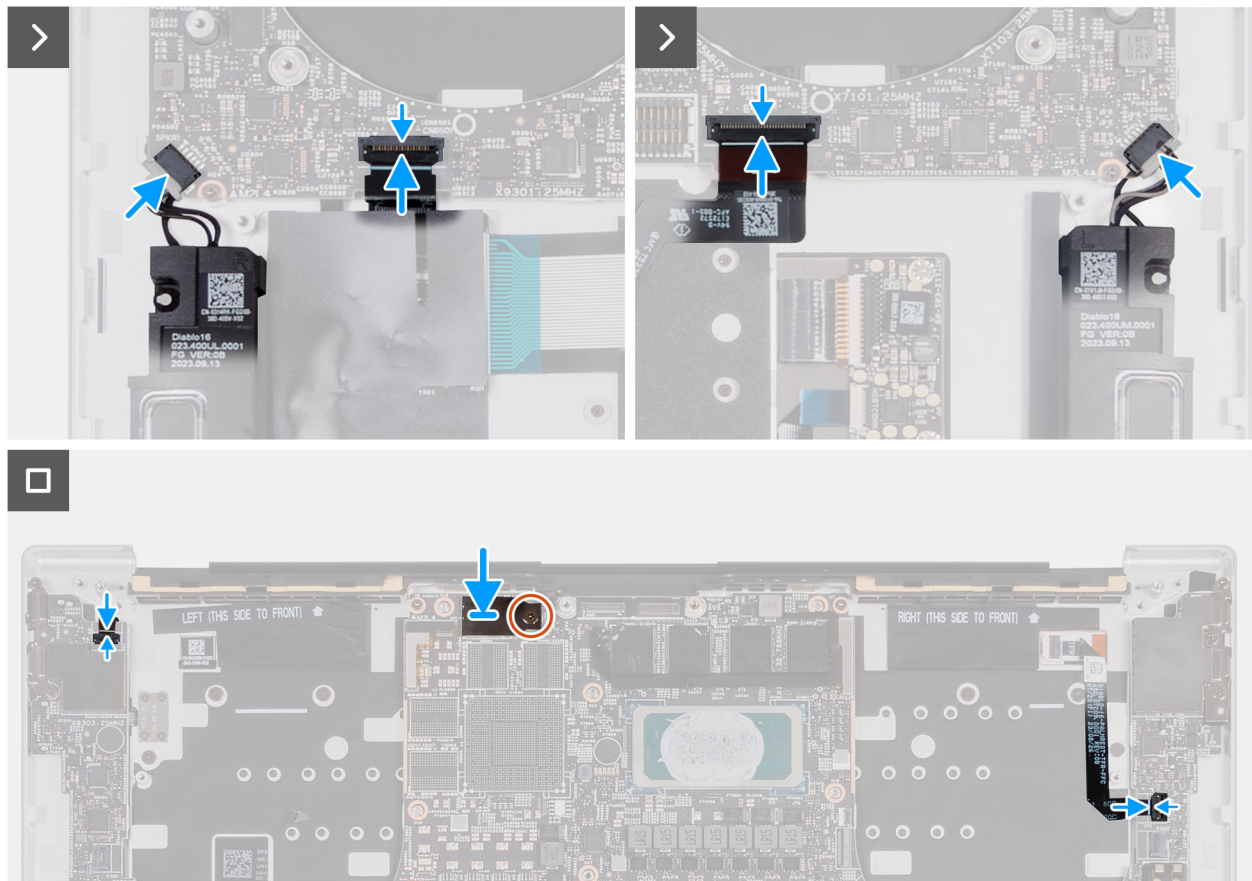

**Figure 51. Installing the system board**

**Steps**

1. Align the screw holes on the system board with the screw holes on the palm rest and keyboard assembly.
2. Replace the four screws (M2x4.5) that secure the system board to the palm rest and keyboard assembly.
3. Connect the antenna cables to the wireless module.

**NOTE:** The following table provides the antenna-cable connection scheme for the wireless module on your computer.

**Table 27. Antenna-cable connection scheme**

Connectors on the wireless module	Antenna cable	Marking on the module	
Main	Black with label 'M'	MAIN 2	△ (white triangle)
Auxiliary	Black	AUX 1	▲ (black triangle)

4. Connect the speaker (L) cable to the connector (SPKL1) on the system board.
5. Connect the keyboard-controller cable to the connector (CN6501) on the system board and close the latch.
6. Connect the touchpad cable to the connector (TPAD1) on the system board and close the latch.
7. Connect the speaker (R) cable to the connector (SPKR1) on the system board.
8. Connect the power-button and fingerprint-reader cable to the connector (FP1) on the system board.
9. Align the screw hole on the wireless-module shield with the screw hole on the system board.
10. Replace the screw (M2x3) that secures the wireless-module shield to the system board.
11. Connect the capacitive touch-panel cable to the connector (TF1) on the system board.

**Next steps**

1. Install the [Type-C bracket](#).
2. Install the [heat sink](#).



3. Install the [fans](#).
4. Install the [solid-state drive](#).
5. Install the [battery](#).
6. Install the [base cover](#).
7. Follow the procedure in [After working inside your computer](#).

## Speakers

### Removing the speakers

 **CAUTION:** The information in this removal section is intended for authorized service technicians only.

#### Prerequisites

1. Follow the procedure in [Before working inside your computer](#).
2. Remove the [base cover](#).
3. Remove the [battery](#).
4. Remove the [fans](#).
5. Remove the [heat sink](#).
6. Remove the [Type-C brackets](#).
7. Remove the [system board](#).

 **NOTE:** The system board can be removed along with the solid state drive.

#### About this task

The following image(s) indicate the location of the speakers and provides a visual representation of the removal procedure.

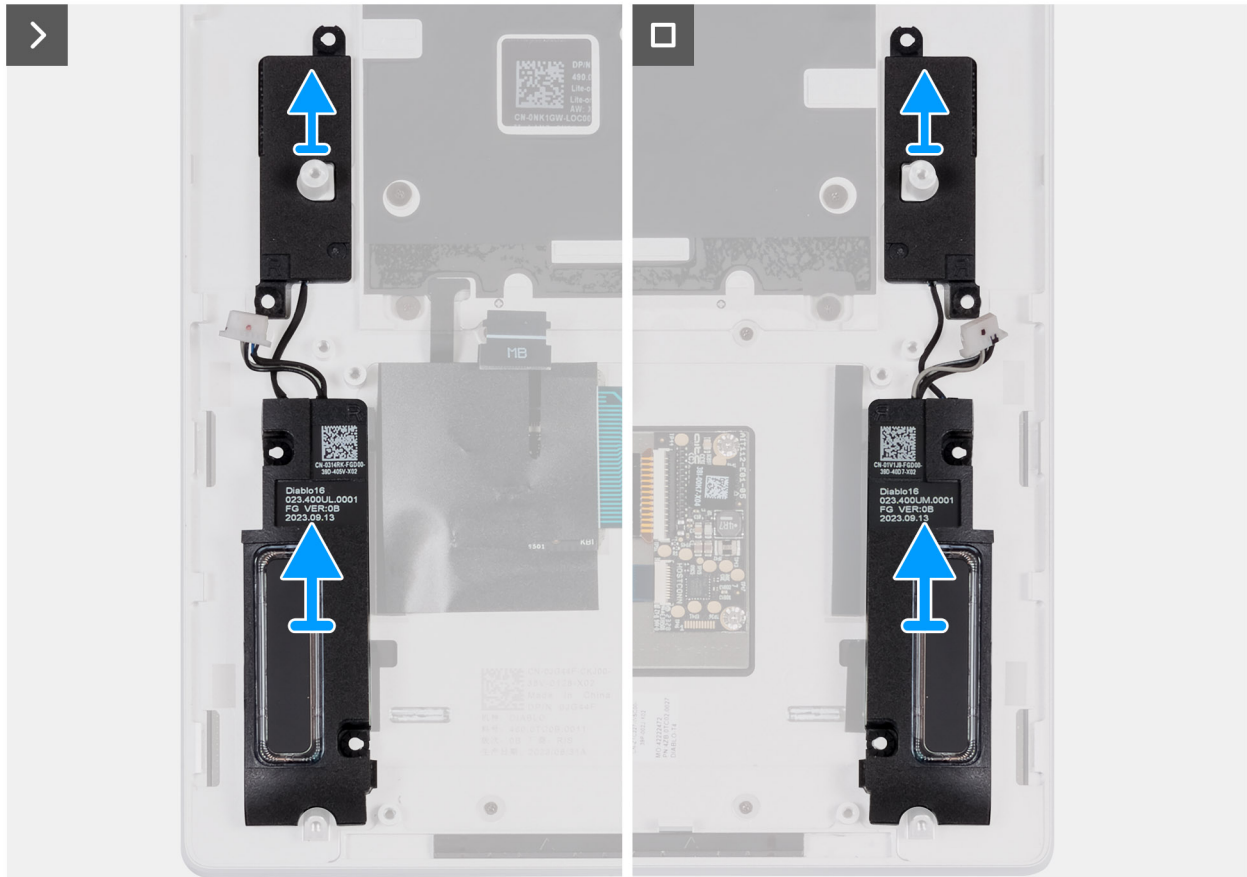
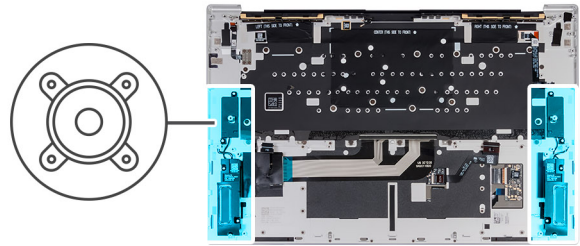

**Figure 52. Removing the speakers**

### Steps

Lift the left and right speakers, along with the cables off the palm rest and keyboard assembly.

## Installing the speakers

**CAUTION:** The information in this installation section is intended for authorized service technicians only.

### Prerequisites

If you are replacing a component, remove the existing component before performing the installation process.

### About this task

The following image(s) indicate the location of the speakers and provides a visual representation of the installation procedure.

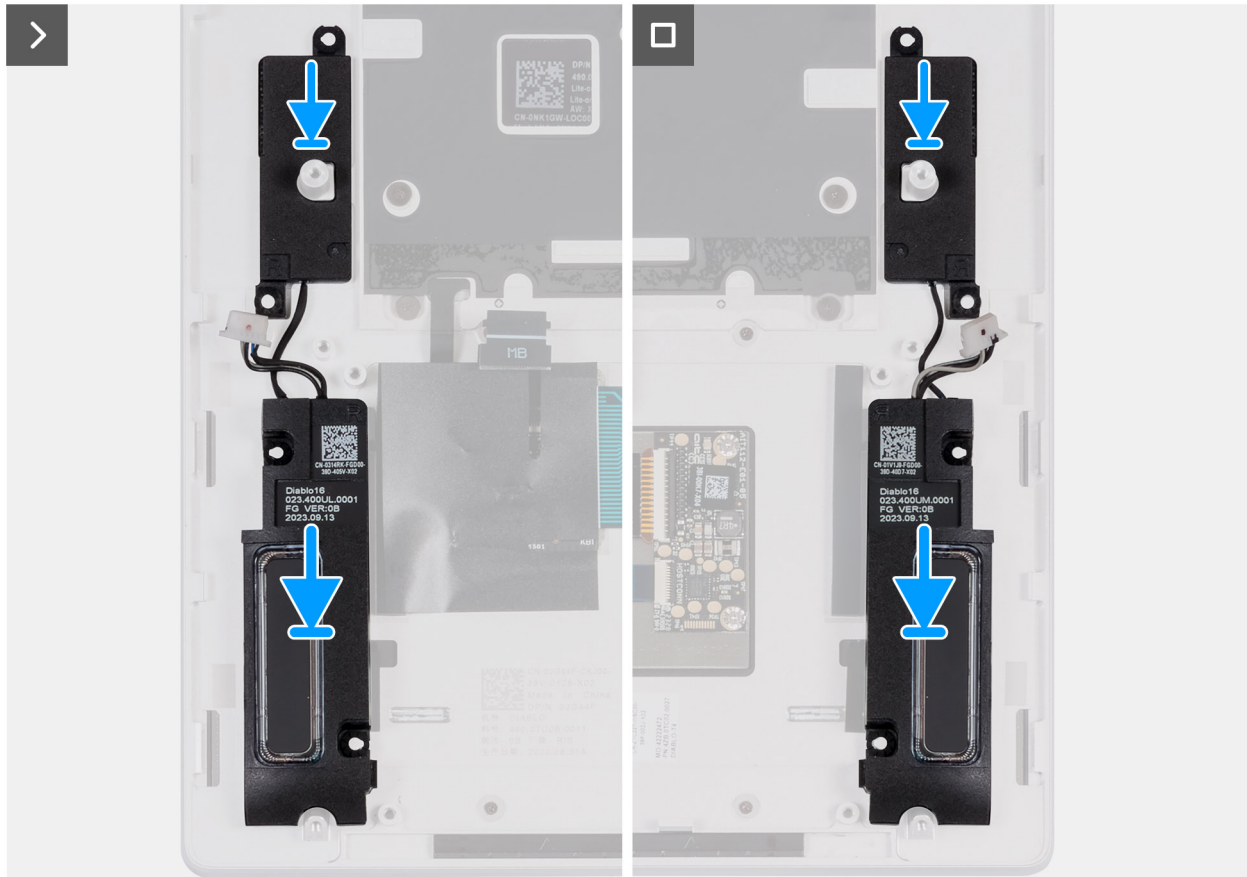
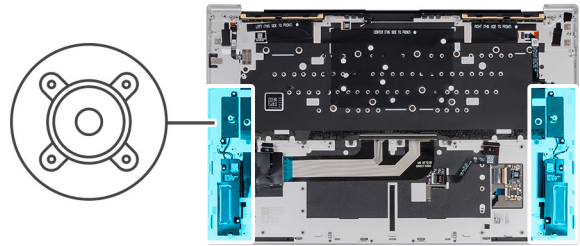

**Figure 53. Installing the speakers**

### Steps

1. Using the alignment posts, place the speaker (R) into the slots on the palm rest and keyboard assembly.
2. Using the alignment posts, place the speaker (L) into the slots on the palm rest and keyboard assembly.

**i** **NOTE:** Ensure that the alignment posts are threaded through the rubber grommets on the speaker.

### Next steps

1. Install the [system board](#).
 

**i** **NOTE:** The system board can be installed along with the solid state drive.
2. Install the [Type-C brackets](#).
3. Install the [heat sink](#).
4. Install the [fans](#).
5. Install the [battery](#).
6. Install the [base cover](#).
7. Follow the procedure in [After working inside your computer](#).

# Keyboard

## Removing the keyboard

 **CAUTION:** The information in this removal section is intended for authorized service technicians only.

### Prerequisites

1. Follow the procedure in [Before working inside your computer](#).
2. Remove the [base cover](#).
3. Remove the [battery](#).
4. Remove the [fans](#).
5. Remove the [heat sink](#).
6. Remove the [Type-C brackets](#).
7. Remove the [system board](#).

 **NOTE:** The system board can be removed along with the solid state drive.

8. Remove the [speakers](#).
9. Remove the [power button with fingerprint reader](#).

### About this task

The following image(s) indicate the location of the keyboard and provides a visual representation of the removal procedure.



23x  
M1.4x1.3

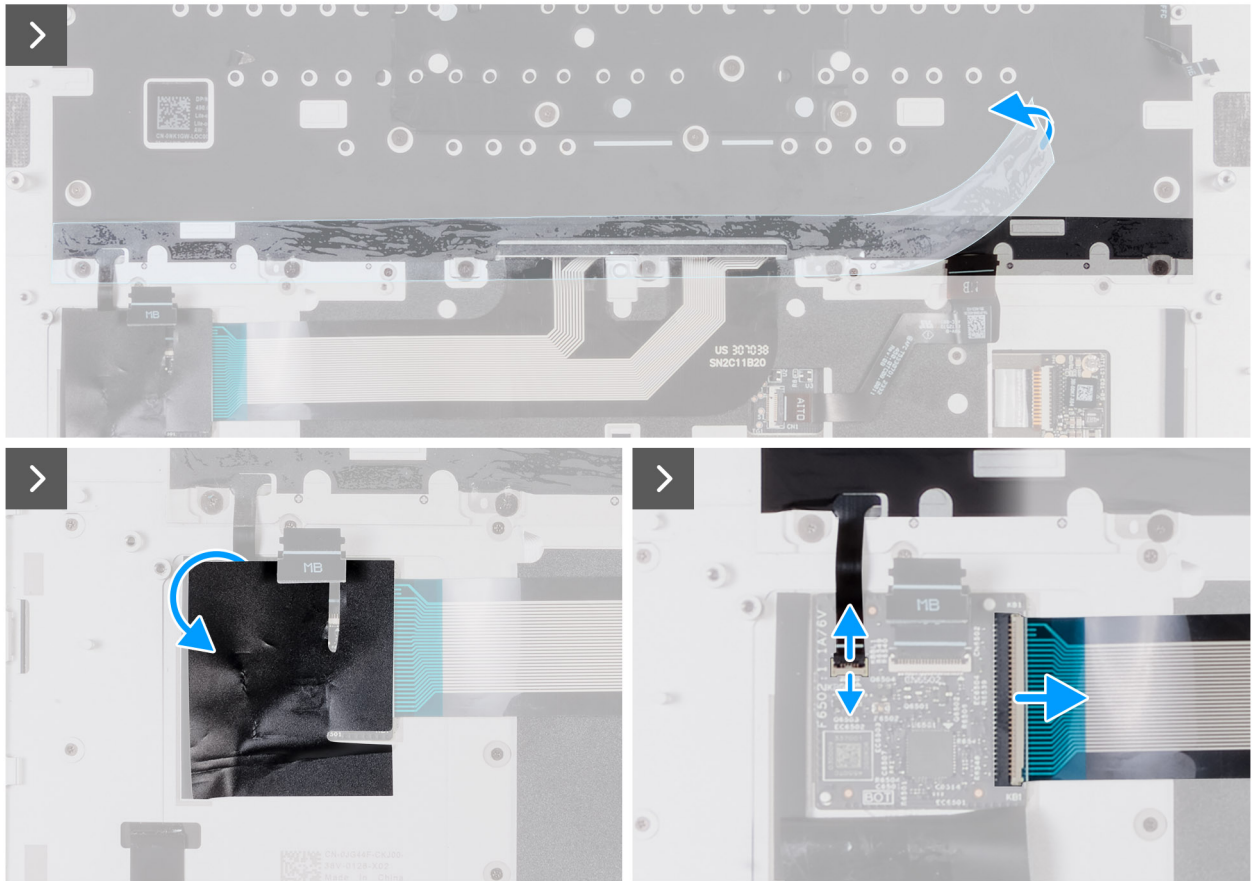
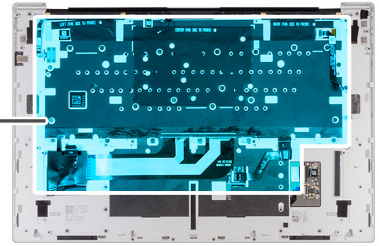

Figure 54. Removing the keyboard

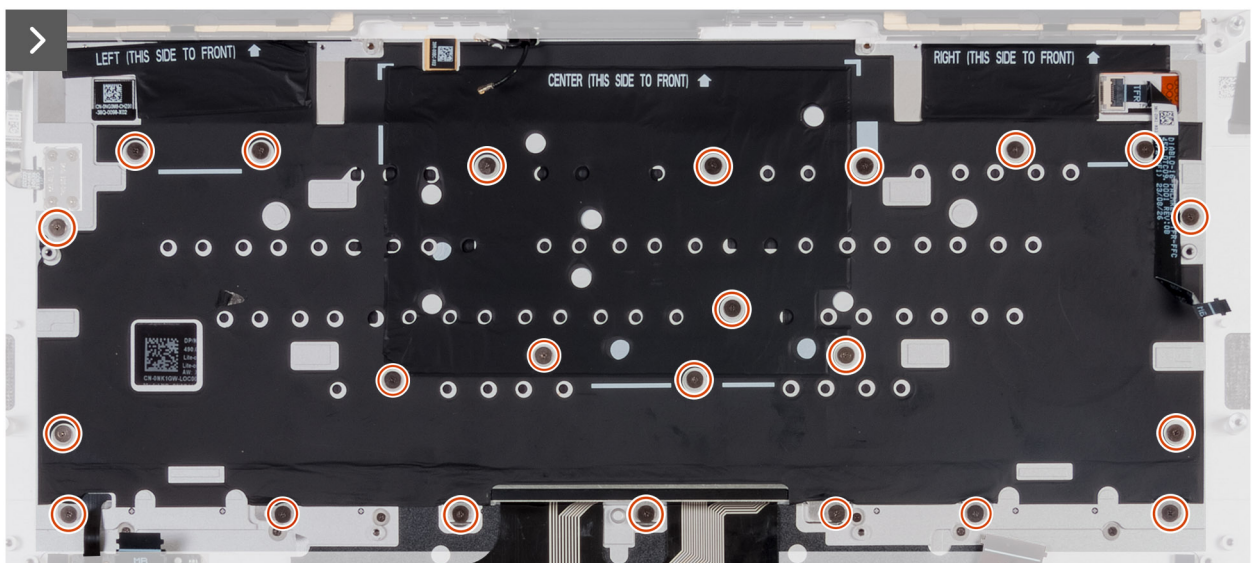
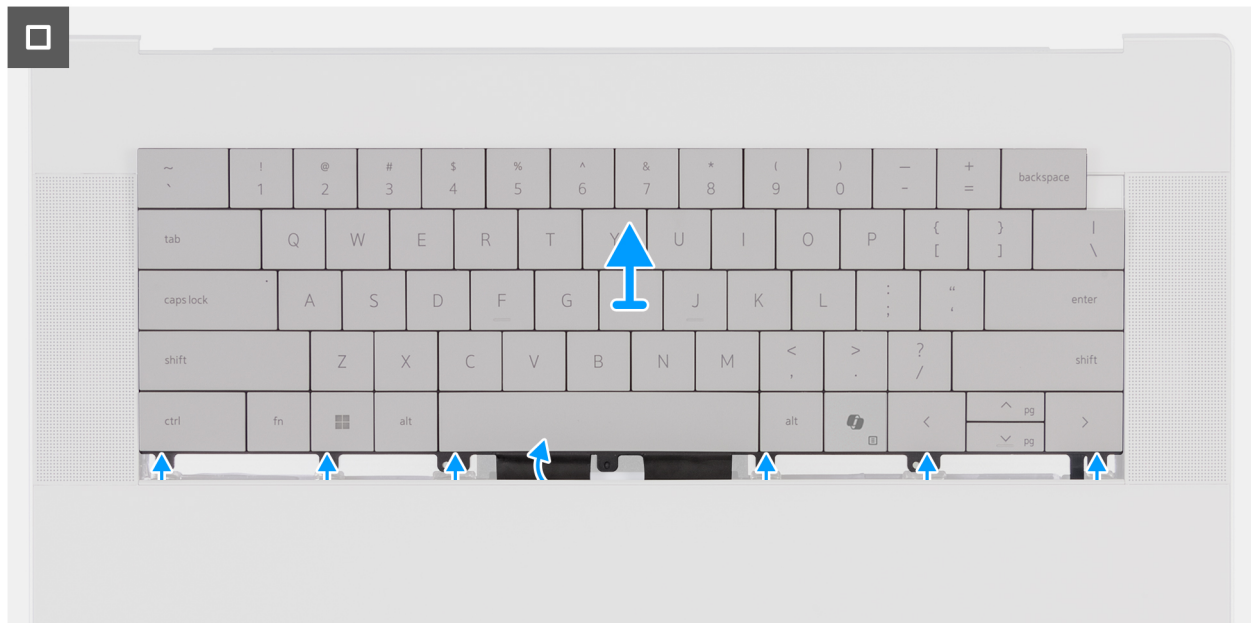

Figure 55. Removing the keyboard



**Figure 56. Removing the keyboard**

### Steps

1. Peel off the tape that adheres the keyboard to the palm rest assembly.
2. Lift off the tape that covers the keyboard-controller board.
3. Open the latch and disconnect the keyboard-backlight cable from the connector (KBBL1) on the keyboard-controller board.
4. Disconnect the keyboard cable from the connector (KB1) on the keyboard-controller board.
5. Remove the twenty-three screws (M1.4x1.3) that secure the keyboard to the palm rest assembly.
6. Turn the palm rest and keyboard assembly over.
7. Slide the keyboard upwards and lift off the keyboard from your computer.

## Installing the keyboard

**CAUTION:** The information in this installation section is intended for authorized service technicians only.

### Prerequisites

If you are replacing a component, remove the existing component before performing the installation process.

### About this task

The following image(s) indicate the location of the palm rest and keyboard assembly and provides a visual representation of the installation procedure.



**23x**  
M1.4x1.3



**6x**  
M1.2x1.8

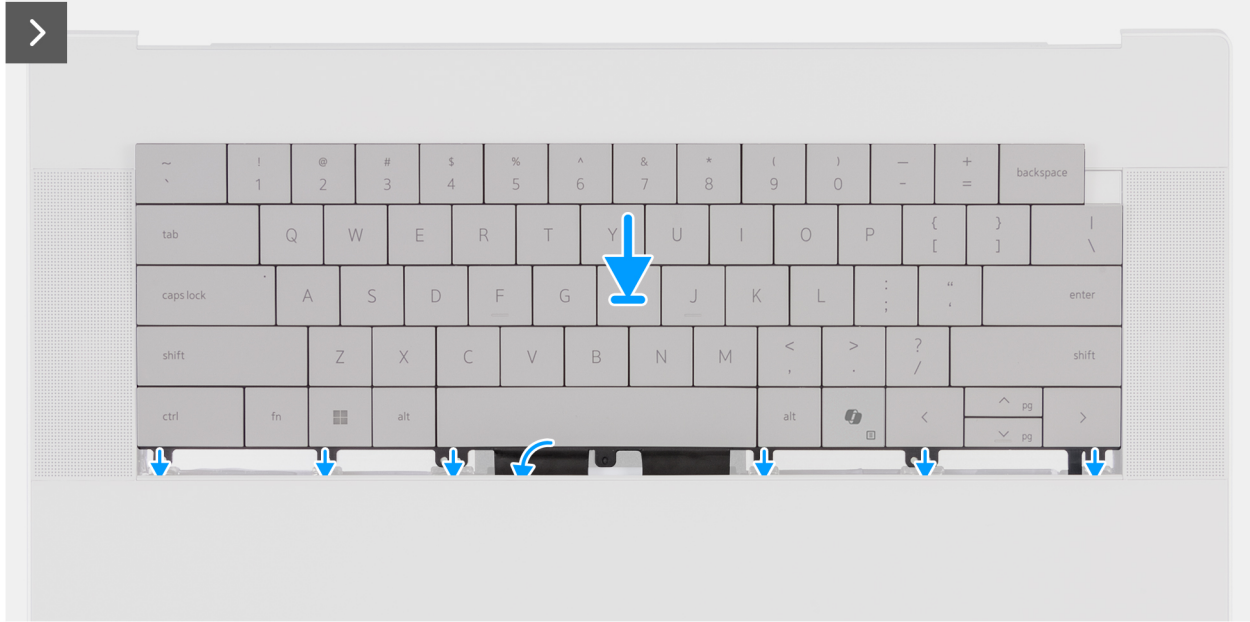
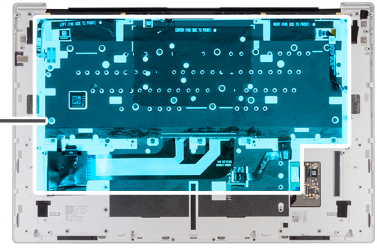

Figure 57. Installing the keyboard

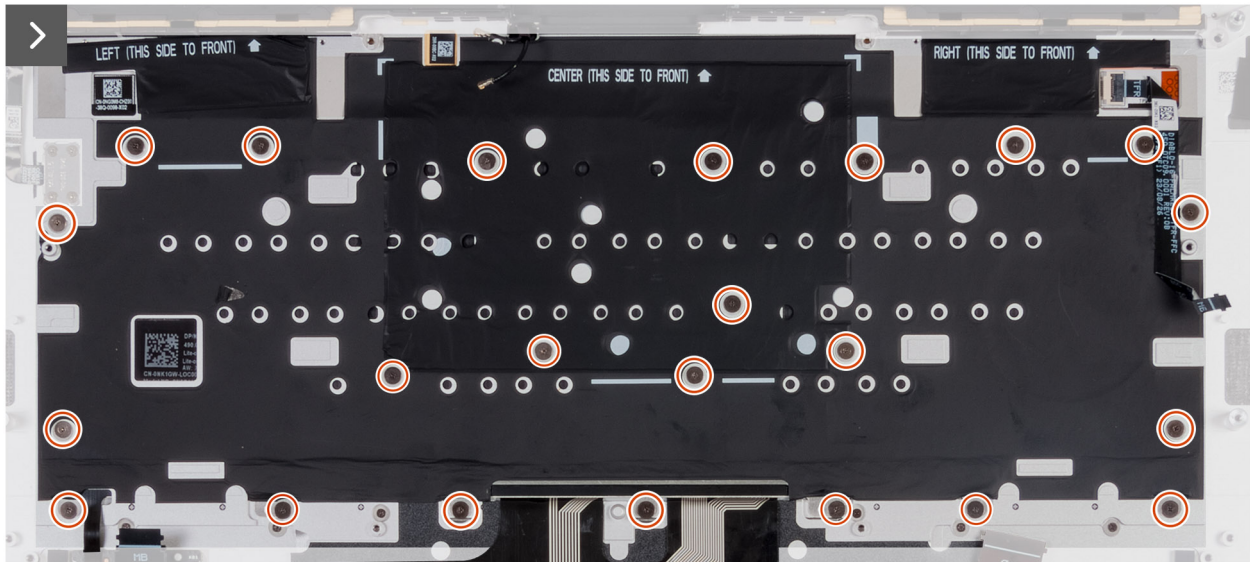
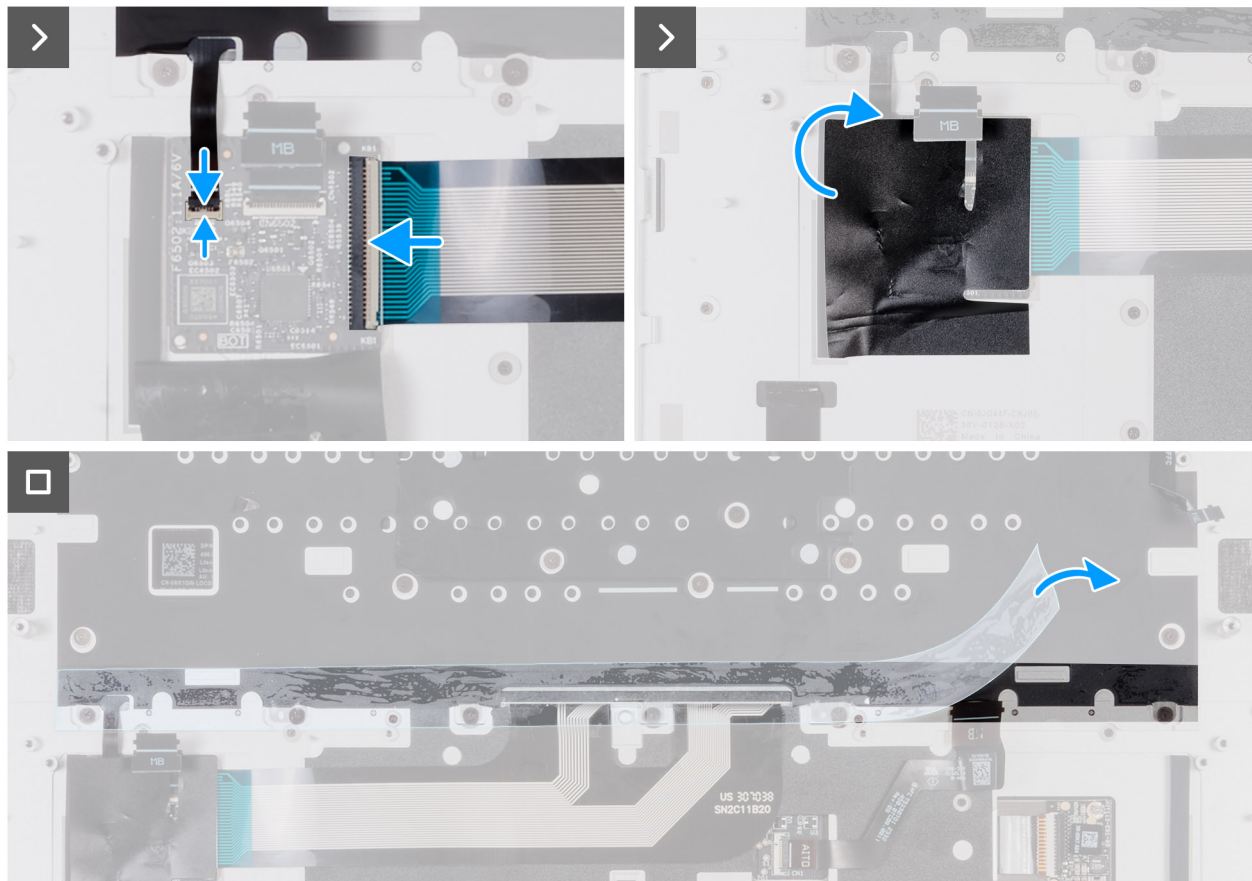

Figure 58. Installing the keyboard



**Figure 59. Installing the keyboard**

### Steps

1. Align and slide the keyboard into position on the palm-rest assembly.
2. Turn the palm rest and keyboard assembly over.
3. Replace the twenty-three screws (M1.4x1.3) that secure the keyboard to the palm rest assembly.
4. Connect the cable from the connector (KB1) to the keyboard-controller board.
5. Connect the keyboard-backlight cable to the connector (KBBL1) on the keyboard-controller board and close the latch.
6. Adhere the tape to secure the keyboard to the palm-rest assembly.

### Next steps

1. Install the [power button with fingerprint reader](#).
  2. Install the [speakers](#).
  3. Install the [system board](#).
- i** **NOTE:** The system board can be installed along with the solid state drive.
4. Install the [Type-C brackets](#).
  5. Install the [heat sink](#).
  6. Install the [fans](#).
  7. Install the [battery](#).
  8. Install the [base cover](#).
  9. Follow the procedure in [After working inside your computer](#).



# Power button with fingerprint reader

## Removing the power button with fingerprint reader

**CAUTION:** The information in this removal section is intended for authorized service technicians only.

### Prerequisites

1. Follow the procedure in [Before working inside your computer](#).
2. Remove the [base cover](#).
3. Remove the [battery](#).
4. Remove the [fans](#).
5. Remove the [heat sink](#).
6. Remove the [Type-C brackets](#).
7. Remove the [system board](#).
- i** **NOTE:** The system board can be removed along with the solid state drive.
8. Remove the [speakers](#).

### About this task

The following image(s) indicate the location of the power button and provides a visual representation of the removal procedure.

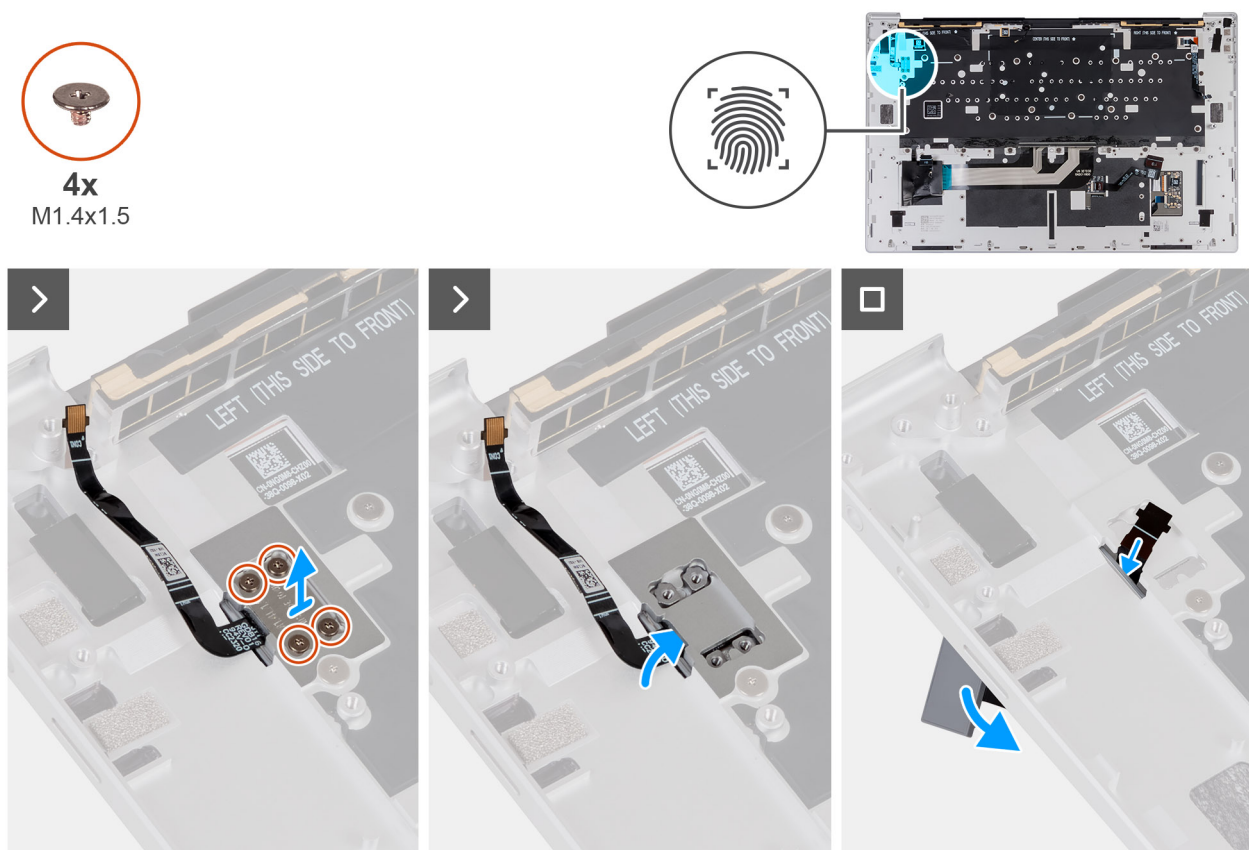

**Figure 60. Removing the power button with fingerprint reader**

### Steps

1. Remove the four screws (M1.4x1.5) that secure the power-button bracket to the palm rest.
2. Lift the power-button bracket off the power button.
3. Nudge the power button from behind the palm rest, along with its cable, and remove from the keyboard.

# Installing the power button with fingerprint reader

**CAUTION:** The information in this installation section is intended for authorized service technicians only.

## Prerequisites

If you are replacing a component, remove the existing component before performing the installation process.

## About this task

The following image(s) indicate the location of the power button and provides a visual representation of the installation procedure.

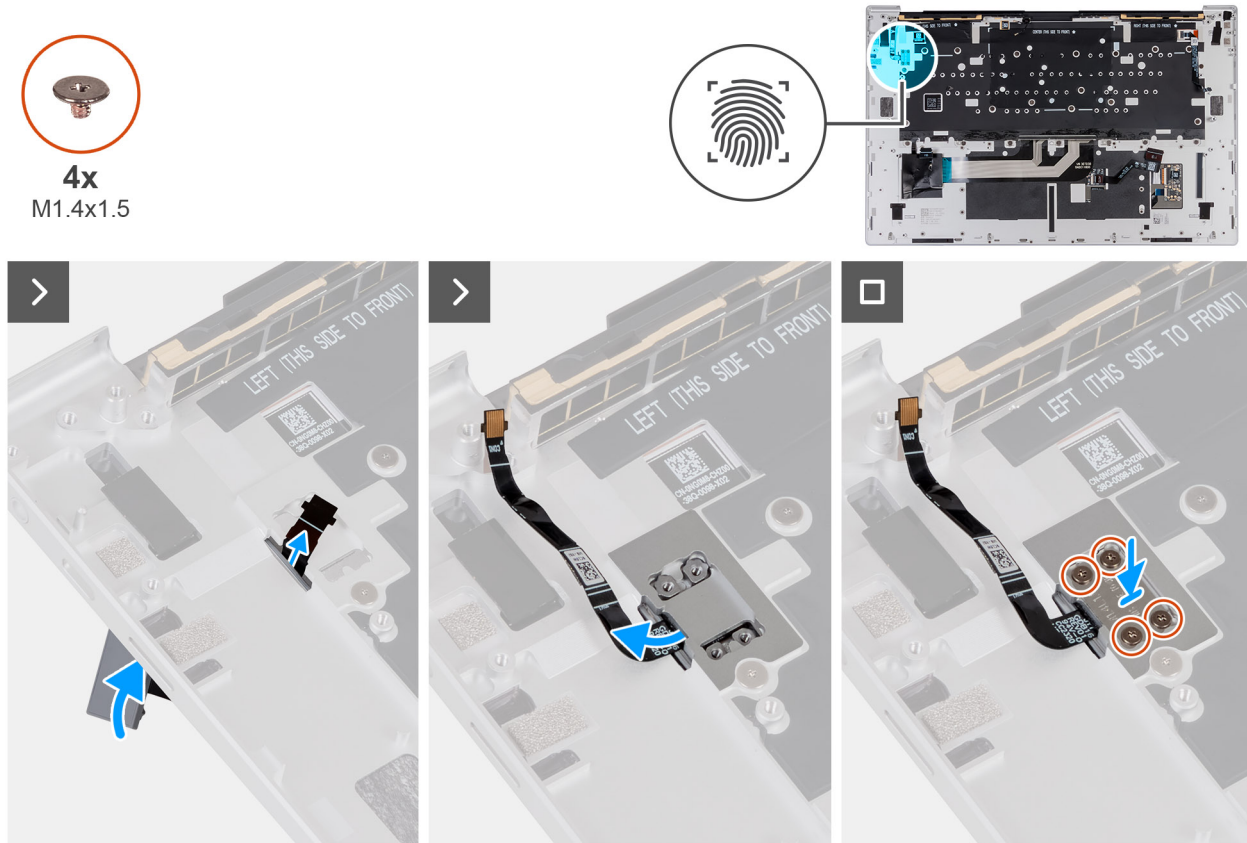

**Figure 61. Installing the power button with fingerprint reader**

## Steps

1. Align and place the power button, along with its cable, into the slot on the palm rest.
2. Align the screw holes on the power-button bracket with the screw holes on the palm rest.
3. Replace the four screws (M1.4x1.5) that secure the power-button bracket to the palm rest and keyboard assembly.

## Next steps

1. Install the [speakers](#).
2. Install the [system board](#).  
**NOTE:** The system board can be installed along with the solid state drive.
3. Install the [Type-C bracket](#).
4. Install the [heat sink](#).
5. Install the [fans](#).
6. Install the [solid-state drive](#).
7. Install the [battery](#).

8. Install the [base cover](#).
9. Follow the procedure in [After working inside your computer](#).

## Palm-rest assembly

### Removing the palm-rest assembly

 **CAUTION:** The information in this removal section is intended for authorized service technicians only.

#### Prerequisites

1. Follow the procedure in [Before working inside your computer](#).
2. Remove the [base cover](#).
3. Remove the [display assembly](#).
4. Remove the [battery](#).
5. Remove the [fans](#).
6. Remove the [heat sink](#).
7. Remove the [Type-C brackets](#).
8. Remove the [system board](#).

 **NOTE:** The system board can be removed along with the solid state drive.

9. Remove the [speakers](#).
10. Remove the [keyboard](#).
11. Remove the [power button with fingerprint reader](#).

#### About this task

 **NOTE:** The replacement palm-rest assembly comes preassembled with these components:

- Palm rest
- Touchpad
- Haptic touch-panel module
- Keyboard-control board

The following image indicates the location of the palm-rest assembly and provides a visual representation of the removal procedure.

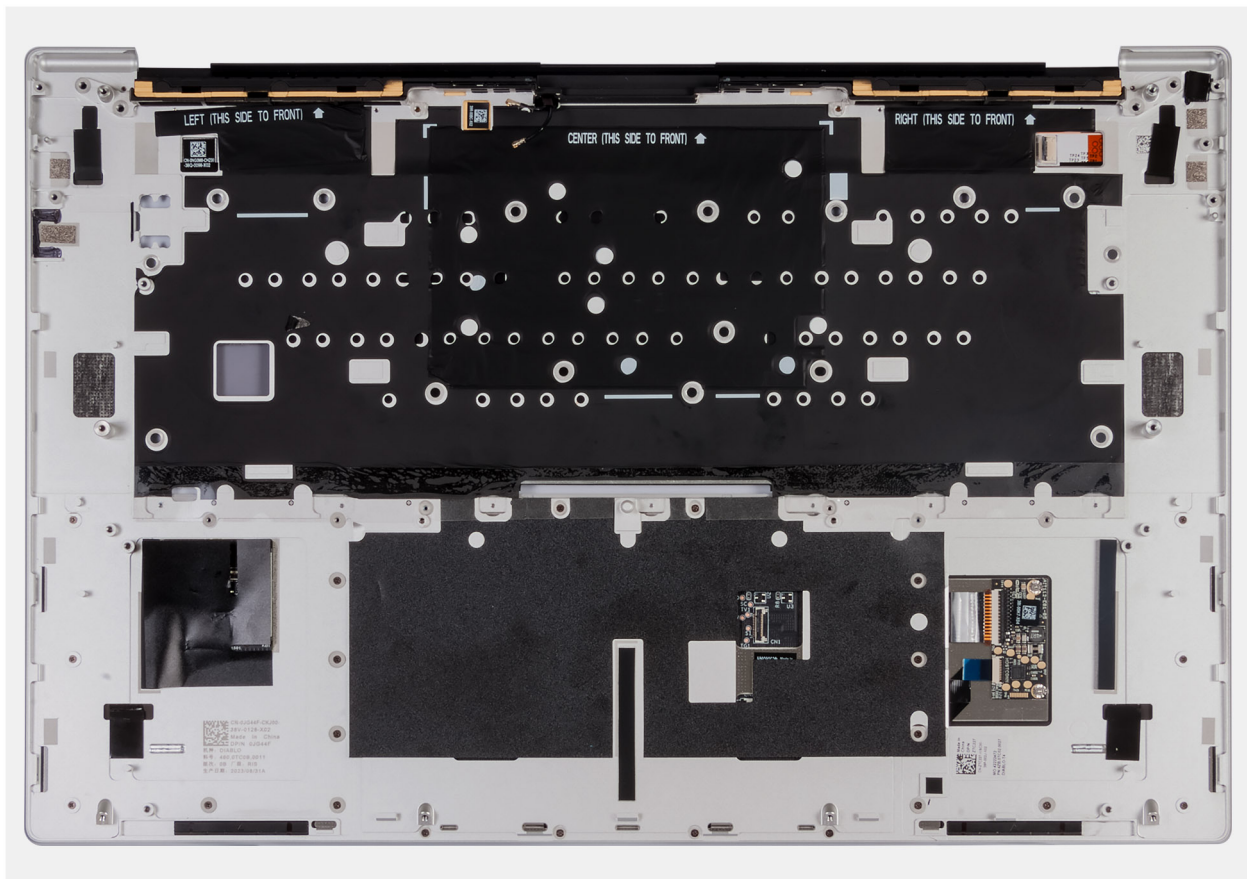

Figure 62. Palm-rest assembly

### Steps

After performing the steps in the pre-requisites, you are left with the palm-rest assembly.

## Installing the palm-rest assembly

**CAUTION:** The information in this installation section is intended for authorized service technicians only.

### Prerequisites

If you are replacing a component, remove the existing component before performing the installation process.

### About this task

**NOTE:** The replacement palm-rest assembly comes preassembled with these components:

- Palm rest
- Touchpad
- Haptic touch-panel module
- Keyboard-control board

The following image indicates the location of the palm-rest assembly and provides a visual representation of the removal procedure.

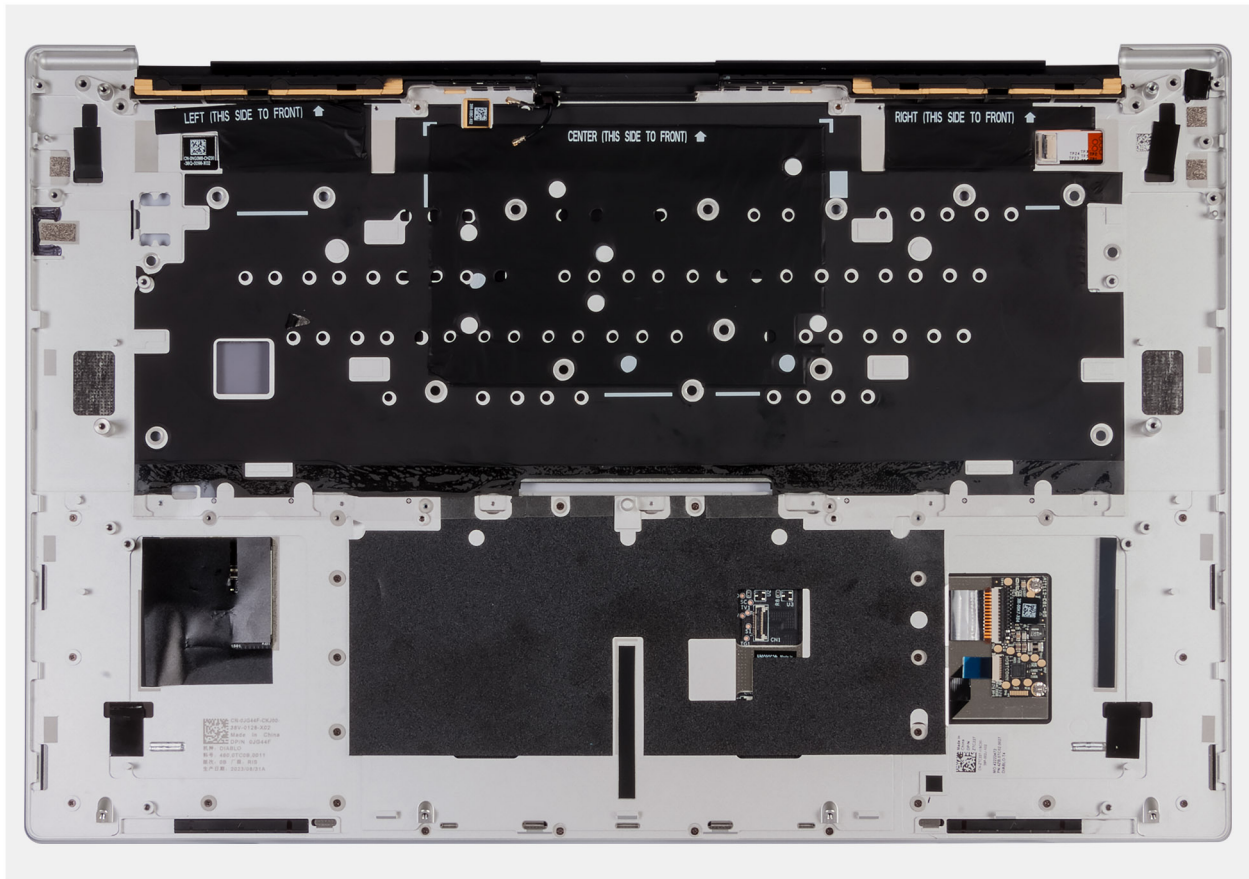

**Figure 63. Palm-rest assembly**

### Steps

Place the palm-rest assembly on a flat surface.

### Next steps

1. Install the [power button with fingerprint reader](#).
2. Install the [keyboard](#).
3. Install the [speakers](#).
4. Install the [system board](#).  
**i** **NOTE:** The system board can be installed along with the solid state drive.
5. Install the [Type-C bracket](#).
6. Install the [heat sink](#).
7. Install the [fans](#).
8. Install the [battery](#).
9. Install the [base cover](#).
10. Follow the procedure in [After working inside your computer](#).

# Software

This chapter details the supported operating systems along with instructions on how to install the drivers.

## Operating system

Your XPS 16 9640 supports the following operating systems:

- Windows 11 Home, 64-bit
- Windows 11 Pro, 64-bit

## Drivers and downloads

When troubleshooting, downloading, or installing drivers, it is recommended that you read the Dell Knowledge Base article, Drivers and Downloads FAQs [000123347](#).

# BIOS Setup

**CAUTION:** Unless you are an expert computer user, do not change the settings in the BIOS Setup. Certain changes can make your computer work incorrectly.

**NOTE:** Depending on the computer and its installed devices, the items that are listed in this section may or may not be displayed.

**NOTE:** Before you change the settings in BIOS Setup, it is recommended that you note down the original settings for future reference.

Use BIOS Setup for the following purposes:

- Get information about the hardware installed in your computer, such as the amount of RAM and the size of the hard drive.
- Change the system configuration information.
- Set or change a user-selectable option, such as the user password, type of hard drive installed, and enabling or disabling base devices.

## Entering BIOS Setup program

### About this task

Turn on (or restart) your computer and press F2 immediately.

## Navigation keys

**NOTE:** For most of the System Setup options, changes that you make are recorded but do not take effect until you restart the computer.

**Table 28. Navigation keys**

Keys	Navigation
Up arrow	Moves to the previous field.
Down arrow	Moves to the next field.
Enter	Selects a value in the selected field (if applicable) or follows the link in the field.
Spacebar	Expands or collapses a drop-down list, if applicable.
Tab	Moves to the next focus area. <b>NOTE:</b> For the standard graphical user interface only.
Esc	Moves to the previous page until you view the main screen. Pressing Esc in the main screen displays a message that prompts you to save any unsaved changes and restart the computer.

## F12 One Time Boot menu

To enter the One Time Boot menu, turn on your computer, and then press F12 immediately.

**NOTE:** It is recommended to shut down the computer, if it is on.

The F12 One Time Boot menu displays the devices that you can boot from including the diagnostic option. The boot menu options are:

- Removable Drive (if available)
- STXXXX Drive (if available)
-  **NOTE:** XXX denotes the SATA drive number.
- Optical Drive (if available)
- SATA Hard Drive (if available)
- Diagnostics

The boot sequence screen also displays the option to access System Setup.

## System setup options

 **NOTE:** Depending on your computer and its installed devices, the items that are listed in this section may or may not be displayed.

**Table 29. BIOS Setup options—Overview menu**

Overview	
<b>XPS 16 9640</b>	
BIOS Version	Displays the BIOS version number.
Service Tag	Displays the Service Tag of the computer.
Asset Tag	Displays the Asset Tag of the computer.
Manufacture Date	Displays the manufacture date of the computer.
Ownership Date	Displays the ownership date of the computer.
Express Service Code	Displays the Express Service Code of the computer.
Ownership Tag	Displays the Ownership Tag of the computer.
Signed Firmware Update	Displays whether the Signed Firmware Update is enabled on your computer. By default, the <b>Signed Firmware Update</b> option is enabled.
<b>BATTERY</b>	
Primary	Displays the primary battery of the computer.
Battery Level	Displays the battery level of the computer.
Battery State	Displays the battery state of the computer.
Health	Displays the battery health of the computer.
AC Adapter	Displays whether an AC adapter is connected. If connected, displays the type of AC adapter that is connected.
<b>PROCESSOR</b>	
Processor Type	Displays the processor type.
Maximum Clock Speed	Displays the maximum processor clock speed.
Minimum Clock Speed	Displays the minimum processor clock speed.
Current Clock Speed	Displays the current processor clock speed.
Core Count	Displays the number of cores on the processor.
Processor ID	Displays the processor identification code.
Processor L2 Cache	Displays the processor L2 Cache size.
Processor L3 Cache	Displays the processor L3 Cache size.



**Table 29. BIOS Setup options—Overview menu (continued)**

<b>Overview</b>	
Microcode Version	Displays the microcode version.
Intel Hyper-Threading Capable	Displays whether the processor is Hyper-Threading (HT) capable.
64-Bit Technology	Displays whether 64-bit technology is used.
<b>MEMORY</b>	
Memory Installed	Displays the total computer memory installed.
Memory Available	Displays the total computer memory available.
Memory Speed	Displays the memory speed.
Memory Channel Mode	Displays single or dual channel mode.
Memory Technology	Displays the technology that is used for the memory.
<b>DEVICES</b>	
Panel Type	Displays the panel type of the computer.
Panel Revision	Displays the revision of the panel
Video Controller	Displays the video controller type of the computer.
Video Memory	Displays the video memory information of the computer.
Wi-Fi Device	Displays the wireless device information of the computer.
Native Resolution	Displays the native resolution of the computer.
Video BIOS Version	Displays the video BIOS version of the computer.
Audio Controller	Displays the audio controller information of the computer.
Bluetooth Device	Displays the Bluetooth device information of the computer.
Pass Through MAC Address	Displays the MAC address of the video pass-through.
dGPU Video Controller	Displays the discrete Graphics Processing Unit (GPU) of the computer. This option is only available on computers that are shipped with discrete GPUs.

**Table 30. BIOS Setup options—Boot Configuration menu**

<b>Boot Configuration</b>	
<b>Boot Sequence</b>	
Boot Mode: UEFI only	Displays the boot mode of the computer.
Boot Sequence	Displays the boot sequence.
Enable PXE Boot Priority	Enables or disables PXE boot detection.
<b>Secure Digital (SD) Card Boot</b>	
	Enables or disables read-only boot from Secure Digital (SD) card. By default, the <b>Secure Digital (SD) Card Boot</b> option is disabled.
<b>Secure Boot</b>	
	Secure Boot is a method of guaranteeing the integrity of the boot path by performing additional validation of the operating system and PCI add-in cards. The computer stops booting to the operating system when a component is not authenticated during the boot process. Secure Boot can be enabled in BIOS setup or using management interfaces like Dell Command Configure, but can only be disabled from BIOS setup.
Enable Secure Boot	Enables the computer to boot using only validated boot software. By default, the <b>Enable Secure Boot</b> option is enabled.

**Table 30. BIOS Setup options—Boot Configuration menu (continued)**

<b>Boot Configuration</b>	
	<p>For additional security, Dell Technologies recommends keeping the <b>Secure Boot</b> option enabled to ensure that the UEFI firmware validates the operating system during the boot process.</p> <p><b>i</b> <b>NOTE:</b> For Secure Boot to be enabled, the computer is required to be in UEFI boot mode and the Enable Legacy Option ROMs option is required to be turned off.</p>
Enable Microsoft UEFI CA	<p>When disabled, the UEFI CA is removed from the BIOS UEFI Secure Boot database.</p> <p><b>i</b> <b>NOTE:</b> When disabled, the Microsoft UEFI CA could render your computer unable to boot, computer graphics may not function, some devices may not function properly, and the computer could become unrecoverable.</p> <p>By default, the <b>Enable Microsoft UEFI CA</b> option is enabled.</p> <p>For additional security, Dell Technologies recommends keeping the <b>Microsoft UEFI CA</b> option enabled to ensure the broadest compatibility with devices and operating systems.</p>
Secure Boot Mode	<p>Enables or disables the Secure Boot operation mode.</p> <p>By default, the <b>Deployed Mode</b> is selected.</p> <p><b>i</b> <b>NOTE:</b> <b>Deployed Mode</b> should be selected for normal operation of Secure Boot.</p>
<b>Expert Key Management</b>	
Enable Custom Mode	<p>Enables or disables the keys in the PK, KEK, db, and dbx security key databases to be modified.</p> <p>By default, the <b>Enable Custom Mode</b> option is disabled.</p>
Custom Mode Key Management	<p>Selects the custom values for expert key management.</p> <p>By default, the <b>PK</b> option is selected.</p>

**Table 31. BIOS Setup options—Integrated Devices menu**

<b>Integrated Devices</b>	
<b>Date/Time</b>	
Date	Sets the computer date in MM/DD/YYYY format. Changes to the date format take effect immediately.
Time	Sets the computer time in HH/MM/SS 24-hour format. You can switch between a 12-hour and 24-hour clock. Changes to the time format take effect immediately.
<b>Camera</b>	
Enable Camera	<p>Enables the camera.</p> <p>By default, the <b>Enable Camera</b> option is enabled.</p> <p><b>i</b> <b>NOTE:</b> Depending on the configuration ordered, the camera setup option may not be available.</p>
<b>Audio</b>	
Enable Audio	<p>Enables all integrated audio controller.</p> <p>By default, all the options are enabled.</p>
Enable Microphone	<p>Enables the microphone.</p> <p>By default, the <b>Enable Microphone</b> option is enabled.</p>

**Table 31. BIOS Setup options—Integrated Devices menu (continued)**

<b>Integrated Devices</b>	
	<p> <b>NOTE:</b> Depending on the configuration ordered, the microphone setup option may not be available.</p>
Enable Internal Speaker	<p>Enables the internal speaker.</p> <p>By default, the <b>Enable Internal Speaker</b> option is enabled.</p>
<b>USB/Thunderbolt Configuration</b>	
Enable USB Boot Support	<p>Enables booting from USB mass storage devices that are connected to external USB ports.</p> <p>By default, the <b>Enable USB Boot Support</b> option is enabled.</p>
Enable External USB Ports	<p>Enables the external USB ports.</p> <p>By default, the <b>Enable External USB Ports</b> option is enabled.</p>
<b>Enable Thunderbolt Technology Support</b>	
Enable Thunderbolt Technology Support	<p>Enables the associated ports and adapters for Thunderbolt Technology support.</p> <p>By default, the <b>Enable Thunderbolt Technology Support</b> option is enabled.</p>
<b>Enable Thunderbolt Boot Support</b>	
Enable Thunderbolt Boot Support	<p>Enables the Thunderbolt adapter-peripheral device and USB devices that are connected to the Thunderbolt adapter to be used during BIOS Preboot.</p> <p>By default, the <b>Enable Thunderbolt Boot Support</b> option is disabled.</p>
<b>Enable Thunderbolt (and PCIe behind TBT) pre-boot modules</b>	<p>Enables the PCIe devices that are connected through a Thunderbolt adapter to run the PCIe devices UEFI Option ROM (if present) during preboot.</p> <p>By default, the <b>Enable Thunderbolt (and PCIe behind TBT) pre-boot modules</b> option is disabled.</p>
<b>Disable USB4 PCIE Tunneling</b>	<p>Disables the USB4 PCIE Tunneling option.</p> <p>By default, the <b>Disable USB4 PCIE Tunneling</b> option is disabled.</p>
<b>Video/Power only on Type-C Ports</b>	<p>Enables or disables the Type-C port functionality to video or only power.</p> <p>By default, the <b>Video/Power only on Type-C Ports</b> option is disabled.</p>
<b>Type-C Dock Override</b>	<p>Enables or disables to use connected Type-C Dell Dock to provide data stream with external USB ports disabled. When Type-C Dock override is enabled, the Video/Audio/LAN submenu is activated.</p> <p>By default, the <b>Type-C Dock Override</b> option is enabled.</p>
<b>Type-C Dock Audio</b>	<p>Enables or disables the usage of audio inputs and outputs from the connected Type-C Dell docking station.</p> <p>By default, the <b>Type-C Dock Audio</b> option is enabled.</p>
<b>Type-C Dock LAN</b>	<p>Enables or disables the usage of LAN on the external ports of the connected Type-C Dell docking station.</p> <p>By default, the <b>Type-C Dock LAN</b> option is enabled.</p>
<b>Miscellaneous Devices</b>	
Enable Fingerprint Reader Device	<p>Enables the Fingerprint Reader Device option.</p> <p>By default, the <b>Enable Fingerprint Reader Device</b> option is enabled.</p>

**Table 32. BIOS Setup options—Storage menu**

<b>Storage</b>	
<b>SATA/NVMe Operation</b>	
SATA/NVMe Operation	Sets the operating mode of the integrated SATA hard drive controller.  By default, the <b>AHCI/NVMe</b> option is selected. The storage device is configured for AHCI/NVMe mode.
<b>Storage Interface</b>	
Port Enablement	Enables or disables the M.2 PCIe SSD option.  By default, the <b>M.2 PCIe SSD</b> option is enabled.
<b>SMART Reporting</b>	
Enable SMART Reporting	Sends analytical information from integrated drives and notifications during startup about potential failure of the hard drive to the BIOS. Controls whether hard drive errors for integrated drives are reported during system startup. This technology is part of the SMART (Self-Monitoring Analysis and Reporting Technology) specification.  By default, the <b>Enable SMART Reporting</b> option is disabled.
<b>Drive Information</b>	
<b>Enable MediaCard</b>	
Secure Digital (SD) Card	Enables or disables the SD card.  By default, the <b>Secure Digital (SD) Card</b> option is enabled.
Secure Digital (SD) Card Read-Only Mode	Enables or disables the SD card read-only mode.  By default, the <b>Secure Digital (SD) Card Read-Only Mode</b> option is disabled.

**Table 33. BIOS Setup options—Display menu**

<b>Display</b>	
<b>Display Brightness</b>	
Brightness on battery power	Enables to set the screen brightness when the computer is running on battery power.  By default, the screen brightness is set to 50 when the computer is running on battery power.
Brightness on AC power	Enables to set the screen brightness when the computer is running on AC power.  By default, the screen brightness is set to 100 when the computer is running on AC power.
<b>Touchscreen</b>	
Enables or disables the touch screen option.  By default, the <b>Touchscreen</b> option is enabled.	
<b>EcoPower</b>	
Enable EcoPower	Enables or disables the EcoPower feature of the panel. EcoPower increases the battery life by reducing the display brightness when appropriate.  By default, the <b>Enable EcoPower</b> option is enabled.
<b>Full Screen Logo</b>	
Enables or disables the computer to display a full-screen logo, if the image matches screen resolution.  By default, the <b>Full Screen Logo</b> option is disabled.	

**Table 33. BIOS Setup options—Display menu (continued)**

Display	
<b>Hybrid Graphics/Advanced Options</b>	 <b>NOTE:</b> The <b>Hybrid Graphics/Advanced Options</b> is applicable to computers shipped with integrated and discrete graphics controllers.
Enable Hybrid Graphics/ Advanced Options (when available)	Allows both integrated and discrete graphics to work together to optimize battery life.
Discrete Graphics Controller Direct Output Mode	Enables or disables the touch screen option.  By default, the <b>Discrete Graphics Controller Direct Output Mode</b> option is disabled.

**Table 34. BIOS Setup options—Connection menu**

Connection	
<b>Wireless Device Enable</b>	
WLAN	Enables or disables the internal WLAN device.  By default, the <b>WLAN</b> option enabled.
Bluetooth	Enables or disables the internal Bluetooth device.  By default, the <b>Bluetooth</b> option enabled.
<b>Enable UEFI Network Stack</b>	Enables or disables the UEFI Network Stack and controls the onboard LAN Controller.  By default, the <b>Enable UEFI Network Stack</b> option is enabled.
<b>Wireless Radio Control</b>	
Control WLAN Radio	Enables to sense the connection of the computer to a wired network and then disables the selected wireless radios (WLAN and/or WWAN). Upon disconnection from the wired network, the selected wireless radios are reenabled.  By default, the <b>Control WLAN Radio</b> option is disabled.
<b>HTTP(s) Boot Feature</b>	
HTTP(s) Boot	Enable or disable HTTP(s) boot capabilities.  By default, the <b>HTTP(s) Boot</b> option is enabled.
HTTP(s) Boot Modes	Select the mode to automatically extract Boot URL from the Dynamic Host Configuration Protocol (DHCP) or manually read Boot URL as provided by the user.  By default, the <b>Auto Mode</b> option is enabled.

**Table 35. BIOS Setup options—Power menu**

Power	
<b>Battery Configuration</b>	Enables or disables the computer to run on battery during peak power usage hours. Use the table <b>Custom Charge Start</b> and <b>Custom Charge Stop</b> , to prevent AC power usage between certain times of each day.  By default, the <b>Adaptive</b> option is selected. Battery settings are adaptively optimized based on your typical battery usage pattern.
<b>Advanced Configuration</b>	
Enable Advanced Battery Charge Configuration	Enables Advanced Battery Charge Configuration from the beginning of the day to a specified work period. When enabled, Advanced Battery Charged maximizes battery health while still supporting heavy use during the work day.

**Table 35. BIOS Setup options—Power menu (continued)**

<b>Power</b>	
	By default, the <b>Enable Advanced Battery Charge Configuration</b> option is disabled.
<b>Peak Shift</b>	
Enable Peak Shift	Enables the computer to run on battery during peak power usage hours. By default, the <b>Enable Peak Shift</b> option is disabled.
<b>Thermal Management</b>	
	Enables or disables cooling of fan and manages processor heat to adjust the computer performance, noise, and temperature. By default, the <b>Optimized</b> option is selected. Standard setting for balanced performance, noise, and temperature.
<b>USB Wake Support</b>	
Wake on Dell USB-C Dock	When enabled, connecting a Dell USB-C Dock wakes the computer from Standby, Hibernate, and Power Off. By default, the <b>Wake on Dell USB-C Dock</b> option is enabled.
<b>Block Sleep</b>	
	Enables or disables the computer from entering Sleep (S3) mode in the operating system. By default, the <b>Block Sleep</b> option is disabled. <b>i</b> <b>NOTE:</b> When enabled, the computer does not go to Sleep, Intel Rapid Start is disabled automatically, and the operating system power option is blank if it was set to Sleep.
<b>Lid Switch</b>	
Enable Lid Switch	Enables or disables the Lid Switch. By default, the <b>Enable Lid Switch</b> option is enabled.
Power On Lid Open	When enabled, it allows the computer to turn on from the off state whenever the lid is opened. By default, the <b>Power On Lid Open</b> option is enabled.
<b>Intel Speed Shift Technology</b>	
	Enables or disables the Intel Speed Shift Technology support. When enabled, the operating system selects the appropriate processor performance automatically. By default, the <b>Intel Speed Shift Technology</b> option is enabled.



**Table 36. BIOS Setup options—Security menu**

<b>Security</b>	
<b>TPM 2.0 Security</b>	
	The Trusted Platform Module (TPM) provides various cryptographic services which serve as the cornerstone for many platform security technologies. Trusted Platform Module (TPM) is a security device that stores computer-generated keys for encryption and features such as BitLocker, Virtual Secure Mode, remote Attestation. By default, the <b>TPM 2.0 Security</b> option is enabled. For additional security, Dell Technologies recommends keeping <b>Trusted Platform Module (TPM)</b> enabled to allow these security technologies to fully function. <b>i</b> <b>NOTE:</b> The options that are listed apply to computers with a discrete <b>Trusted Platform Module (TPM)</b> chip. For additional security, Dell Technologies recommends keeping <b>TPM 2.0 Security On</b> enabled to allow these security technologies to fully function.

**Table 36. BIOS Setup options—Security menu (continued)**

<b>Security</b>	
Attestation Enable	<p>The <b>Attestation Enable</b> option controls the endorsement hierarchy of TPM. Disabling the <b>Attestation Enable</b> option prevents TPM from being used to digitally sign certificates.</p> <p>By default, the <b>Attestation Enable</b> option is enabled.</p> <p>For additional security, Dell Technologies recommends keeping the <b>Attestation Enable</b> option enabled.</p> <p><b>NOTE:</b> When disabled, this feature may cause compatibility issues or loss of functionality in some operating systems.</p>
Key Storage Enable	<p>The <b>Key Storage Enable</b> option controls the storage hierarchy of TPM, which is used to store digital keys. Disabling the <b>Key Storage Enable</b> option restricts the ability of TPM to store owner's data.</p> <p>By default, the <b>Key Storage Enable</b> option is enabled.</p> <p>For additional security, Dell Technologies recommends keeping the <b>Key Storage Enable</b> option enabled.</p> <p><b>NOTE:</b> When disabled, this feature may cause compatibility issues or loss of functionality in some operating systems.</p>
SHA-256	<p>Allows you to control the hashing algorithm that is used by the TPM. When enabled, the TPM uses the SHA-256 hashing algorithm. When disabled, the TPM uses the SHA-1 hash algorithm.</p> <p>By default, the <b>SHA-256</b> option is enabled.</p> <p>For additional security, Dell Technologies recommends keeping the <b>SHA-256</b> option enabled.</p>
Clear	<p>When enabled, the <b>Clear</b> option clears information that is stored in the TPM after exiting the computer's BIOS. This option returns to the disabled state when the computer restarts.</p> <p>By default, the <b>Clear</b> option is disabled.</p> <p>Dell Technologies recommends enabling the <b>Clear</b> option only when TPM data is required to be cleared.</p>
Physical Presence Interface (PPI) Bypass for Enable Commands	<p>The Physical Presence Interface (PPI) Bypass options can be used to allow the operating system to manage certain aspects of the TPM. If these options are enabled, you are not prompted to confirm certain changes to the TPM configuration.</p> <p>By default, the <b>PPI Bypass for Enable Commands</b> option is enabled.</p> <p>For additional security, Dell Technologies recommends keeping the <b>PPI Bypass for Enable Commands</b> option enabled.</p>
<b>Intel Total Memory Encryption</b>	
Multi-Key Total Memory Encryption (Up to 16 keys)	<p>Enable or disable the protection of memory from physical attacks including freeze spray, probing DDR to read the cycles, and others. When enabled, the system memory is encrypted by the Total Memory Encryption (TME) block attached to the memory controller.</p> <p>By default, the <b>Multi-Key Total Memory Encryption</b> option is disabled.</p>
<b>Chassis intrusion</b>	
Chassis Intrusion Detection	<p>The chassis intrusion detection enables a physical switch that triggers an event when the computer cover is opened.</p> <p>When set to <b>Enabled</b>, a notification is displayed on the next boot and the event is logged in the BIOS Events log.</p>

**Table 36. BIOS Setup options—Security menu (continued)**

<b>Security</b>	<p>When set to <b>On-Silent</b>, the event is logged in the BIOS Events log, but no notification is displayed.</p> <p>When set to <b>Disabled</b>, no notification is displayed and no event is logged in the BIOS Events log.</p> <p>By default, the <b>Chassis Intrusion Detection</b> option is enabled.</p> <p>For additional security, Dell Technologies recommends keeping the <b>Chassis Intrusion Detection</b> option enabled.</p>
<b>SMM Security Mitigation</b>	<p>Enables or disables additional UEFI SMM Security Mitigation protections. This option uses the Windows SMM Security Mitigations Table (WSMT) to confirm to the operating system that security best practices have been implemented by the UEFI firmware.</p> <p>By default, the <b>SMM Security Mitigation</b> option is enabled.</p> <p>For additional security, Dell Technologies recommends keeping the <b>SMM Security Mitigation</b> option enabled unless you have a specific application which is not compatible.</p> <p> <b>NOTE:</b> This feature may cause compatibility issues or loss of functionality with some legacy tools and applications.</p>
<b>Data Wipe on Next Boot</b>	<p><b>Start Data Wipe</b></p> <p>Data Wipe is a secure wipe operation that deletes information from a storage device.</p> <p> <b>CAUTION:</b> The secure Data Wipe operation deletes information in a way that it cannot be reconstructed.</p> <p>Commands such as delete and format in the operating system may remove files from showing up in the file system. However, they can be reconstructed through forensic means as they are still represented on the physical media. Data Wipe prevents this reconstruction and is not recoverable.</p> <p>When enabled, the data wipe option will prompt to wipe any storage devices that are connected to the computer on the next boot.</p> <p>By default, the <b>Start Data Wipe</b> option is disabled.</p>
Absolute	<p>Absolute Software provides various cyber security solutions, some requiring software preloaded on Dell computers and integrated into the BIOS. To use these features, you must enable the Absolute BIOS setting and contact Absolute for configuration and activation.</p> <p>By default, the <b>Absolute</b> option is enabled.</p> <p>For additional security, Dell Technologies recommends keeping the <b>Absolute</b> option enabled.</p> <p> <b>NOTE:</b> When the Absolute features are activated, the Absolute integration cannot be disabled from the BIOS setup screen.</p>
UEFI Boot Path Security	<p>Enables or disables the computer to prompt the user to enter the Administrator password (if set) when booting to a UEFI boot path device from the F12 boot menu.</p> <p>By default, the <b>Always Except Internal HDD</b> option is enabled.</p>
<b>Firmware Device Tamper Detection</b>	<p>Allows you to control the firmware device tamper detection feature. This feature notifies the user when the firmware device is tampered. When enabled, a screen warning messages are displayed on the computer and a tamper detection event is logged in the BIOS Events log. The computer fails to reboot until the event is cleared.</p>



**Table 36. BIOS Setup options—Security menu (continued)**

Security	
	<p>By default, the <b>Silent</b> option is enabled. Events of tamper detection are logged, post screen warnings are disabled.</p> <p>For additional security, Dell Technologies recommends keeping the <b>Firmware Device Tamper Detection</b> option enabled.</p>
Clear Firmware Device Tamper Detection	<p>Enables or disables the feature to clear the event and allow booting when a tamper detection event is logged.</p> <p>By default, the <b>Clear Firmware Device Tamper Detection</b> option is disabled.</p>

**Table 37. BIOS Setup options—Passwords menu**

Passwords	
<b>Admin Password</b>	<p>The Administrator Password prevents unauthorized access to the BIOS Setup options. Once the administrator password is set, the BIOS setup options can only be modified after providing the correct password.</p> <p>The following rules and dependencies apply to the Administrator Password -</p> <ul style="list-style-type: none"> <li>• The administrator password cannot be set if computer and/or internal hard drive passwords are previously set.</li> <li>• The administrator password can be used in place of the computer and/or internal hard drive passwords.</li> <li>• When set, the administrator password must be provided during a firmware update.</li> <li>• Clearing the administrator password also clears the computer password (if set).</li> </ul> <p>Dell Technologies recommends using an administrator password to prevent unauthorized changes to BIOS setup options.</p>
<b>System Password</b>	<p>The System Password prevents the computer from booting to an operating system without entering the correct password.</p> <p>The following rules and dependencies apply when the System Password is used -</p> <ul style="list-style-type: none"> <li>• The computer shuts down when idle for approximately 10 minutes at the computer password prompt.</li> <li>• The computer shuts down after three incorrect attempts to enter the computer password.</li> <li>• The computer shuts down when the <b>Esc</b> key is pressed at the System Password prompt.</li> <li>• The computer password is not prompted when the computer resumes from standby mode.</li> </ul> <p>Dell Technologies recommends using the computer password in situations where it is likely that a computer may be lost or stolen.</p>
<b>M.2 PCIe SSD-0</b>	<p>The M.2 PCIe SSD-0 password can be set to prevent unauthorized access of the data stored on the solid-state drive. The computer prompts for the solid-state drive password during boot in order to unlock the drive. A password-secured hard drive stays locked even when removed from the computer or placed into another computer. It prevents an attacker from accessing data on the drive without authorization.</p> <p>The following rules and dependencies apply when the M.2 PCIe SSD-0 password is used -</p> <ul style="list-style-type: none"> <li>• The M.2 PCIe SSD-0 password option cannot be accessed when a drive is disabled in the BIOS setup.</li> <li>• The computer shuts down when idle for approximately 10 minutes at the solid-state drive password prompt.</li> <li>• The computer shuts down after three incorrect attempts to enter the solid-state drive password and treats the drive as not available.</li> </ul>

**Table 37. BIOS Setup options—Passwords menu (continued)**

<b>Passwords</b>	
	<ul style="list-style-type: none"> <li>• The solid-state drive does not accept password unlock attempts after five incorrect attempts to enter the drive password from the BIOS Setup. The solid-state drive password must be reset for the new password unlock attempts.</li> <li>• The computer treats the solid-state drive as not available when the <b>Esc</b> key is pressed at the drive password prompt.</li> <li>• The solid-state drive password is not prompted when the computer resumes from standby mode. When the solid-state drive is unlocked by the user before the computer goes into standby mode, it remains unlocked after the computer resumes from standby mode.</li> <li>• If the computer and solid-state drive passwords are set to the same value, the drive unlocks after the correct computer password is entered.</li> </ul> <p>Dell Technologies recommends using a solid-state drive password to protect unauthorized data access.</p>
<b>Owner Password</b>	<p>The Owner Password is typically used when a computer is loaned or leased, and the end user sets their own computer or hard drive password. The Owner Password can provide override access to unlock the computer when it is returned. The Owner Password cannot be set using BIOS Setup. System lessors are given a tool which enables them to configure the Owner Password.</p> <p>The following rules and dependencies apply when the Owner Password is used -</p> <ul style="list-style-type: none"> <li>• The owner password cannot be set when the administrator password is already set.</li> <li>• The owner password can be used in place of the administrator, computer, or hard drive passwords.</li> </ul> <p><b>i</b> <b>NOTE:</b> The solid-state drive password must have been set on the computer with the owner password.</p> <p>Dell Technologies recommends that only computer lessors use the owner password.</p>
<b>Strong Password</b>	<p>The Strong Password feature enforces stricter rules for administrator, owner, and computer passwords.</p> <p>When enabled, the following rules are enforced -</p> <ul style="list-style-type: none"> <li>• The minimum length of the password is set to eight characters.</li> <li>• The password is required to include at least one upper case and one lower case character.</li> </ul> <p><b>i</b> <b>NOTE:</b> These requirements do not affect the drive password.</p> <p>By default, the <b>Strong Password</b> option is enabled.</p> <p>For additional security, Dell Technologies recommends keeping the <b>Strong Password</b> option enabled as it requires passwords to be more complex.</p>
<b>Password Configuration</b>	<p>The Password configuration page includes several options for changing the requirements of BIOS passwords. You can modify the minimum and maximum length of the passwords and require passwords to contain certain character classes (upper case, lower case, digit, special character).</p> <p>Dell Technologies recommends setting the minimum password length to at least eight characters.</p>
<b>Password Bypass</b>	<p>The <b>Password Bypass</b> option allows the computer to reboot from the operating system without entering the computer or hard drive password. If the computer has already booted to the operating system, it is presumed that the user has already entered the correct computer or hard drive password.</p> <p><b>i</b> <b>NOTE:</b> This option does not remove the requirement to enter the password after shutting down.</p> <p>By default, the <b>Password Bypass</b> option is disabled.</p>

**Table 37. BIOS Setup options—Passwords menu (continued)**

<b>Passwords</b>	
	For additional security, Dell Technologies recommends keeping the <b>Password Bypass</b> option disabled.
<b>Password Changes</b>	
Allow Non-Admin Password Changes	<p>The <b>Allow Non-Admin Password Changes</b> option in BIOS setup allows an end user to set or change the computer or hard drive passwords without entering the administrator password. This gives an administrator control over the BIOS settings but enables an end user to provide their own password.</p> <p>By default, the <b>Allow Non-Admin Password Changes</b> option is disabled.</p> <p>For additional security, Dell Technologies recommends keeping the <b>Allow Non-Admin Password Changes</b> option disabled.</p>
Non-Admin Setup Changes	<p>The <b>Non-Admin Setup Changes</b> option allows an end user to configure the wireless devices without requiring the administrator password.</p> <p>By default, the <b>Non-Admin Setup Changes</b> option is disabled.</p> <p>For additional security, Dell Technologies recommends keeping the <b>Non-Admin Setup Changes</b> option disabled.</p>
<b>Admin Setup Lockout</b>	<p>The <b>Admin Setup Lockout</b> option prevents an end user from even viewing the BIOS setup configuration without first entering the administrator password (if set).</p> <p>By default, the <b>Admin Setup Lockout</b> option is disabled.</p> <p>For additional security, Dell Technologies recommends keeping the <b>Admin Setup Lockout</b> option disabled.</p>
<b>Recovery Password</b>	<p>The Recovery Password can be used when a system owner forgets the administrator, system, or hard drive password. You can get an unlock code from Dell Support over the phone after verifying ownership details. The unlock code overrides and removes the existing password.</p> <p><b>NOTE:</b> When a hard drive password is overridden using this method, the data on the hard drive is erased if secure erase was enabled when setting the password.</p>
<b>Master Password Lockout</b>	
Enable Master Password Lockout	<p>The Master Password Lockout setting allows you to disable the Recovery Password feature. If the computer, administrator, or hard drive password is forgotten, the computer becomes unusable.</p> <p><b>NOTE:</b> When the owner password is set, the Master Password Lockout option is not available.</p> <p><b>NOTE:</b> When an internal hard drive password is set, it must first be cleared before Master Password Lockout can be changed.</p> <p>By default, the <b>Enable Master Password Lockout</b> option is disabled.</p> <p>Dell does not recommend enabling the <b>Master Password Lockout</b> unless you have implemented your own password recovery computer.</p>

**Table 38. BIOS Setup options—Update, Recovery menu**

<b>Update, Recovery</b>	
<b>UEFI Capsule Firmware Updates</b>	
Enable UEFI Capsule Firmware Updates	<p>Enables or disables BIOS updates through UEFI capsule update packages.</p> <p><b>NOTE:</b> Disabling this option blocks the BIOS updates from services such as Microsoft Windows Update and Linux Vendor Firmware Service (LVFS).</p>

**Table 38. BIOS Setup options—Update, Recovery menu (continued)**

Update, Recovery	
	By default, the <b>Enable UEFI Capsule Firmware Updates</b> option is enabled.
<b>BIOS Recovery from Hard Drive</b>	<p>Enables or disables the user to recover from certain corrupted BIOS conditions from a recovery file on the user primary hard drive or an external USB key.</p> <p>By default, the <b>BIOS Recovery from Hard Drive</b> option is enabled.</p> <p><b>i</b> <b>NOTE:</b> BIOS Recovery from Hard Drive is not available for self-encrypting drives (SED).</p> <p><b>i</b> <b>NOTE:</b> BIOS recovery is designed to fix the main BIOS block and cannot work if the Boot Block is damaged. In addition, this feature cannot work in the event of EC corruption, ME corruption, or a hardware issue. The recovery image must exist on an unencrypted partition on the drive.</p>
BIOS Downgrade	
Allow BIOS Downgrade	<p>Controls flashing of the computer firmware to previous revisions.</p> <p>By default, the <b>Allow BIOS Downgrade</b> option is enabled.</p>
<b>SupportAssist OS Recovery</b>	<p>Enables or disables the boot flow for SupportAssist OS Recovery tool in the event of certain computer errors.</p> <p>By default, the <b>SupportAssist OS Recovery</b> option is enabled.</p>
<b>BIOSConnect</b>	<p>Enables or disables cloud Service operating system recovery if the main operating system fails to boot with the number of failures equal to or greater than the value specified by the Auto operating system Recovery Threshold setup option and local Service operating system does not boot or is not installed.</p> <p>By default, the <b>BIOSConnect</b> option is enabled.</p>
<b>Dell Auto OS Recovery Threshold</b>	<p>Allows you to control the automatic boot flow for SupportAssist System Resolution Console and for Dell operating system Recovery Tool.</p> <p>By default, the <b>Dell Auto OS Recovery Threshold</b> value is set to 2.</p>

**Table 39. BIOS Setup options—System Management menu**

System Management	
<b>Service Tag</b>	Displays the Service Tag of the computer.
<b>Asset Tag</b>	<p>Creates a computer Asset Tag that can be used by an IT administrator to uniquely identify a particular computer.</p> <p><b>i</b> <b>NOTE:</b> Once set in BIOS, the Asset Tag cannot be changed.</p>
AC Behavior	
Wake on AC	<p>Enables or disables the computer to turn on and go to boot when AC power is supplied to the computer.</p> <p>By default, the <b>Wake on AC</b> option is disabled.</p>
<b>Wake on LAN</b>	<p>Enables or disables the computer to turn on by a special LAN signal.</p> <p>By default, the <b>Wake on LAN</b> option is disabled.</p>
<b>Auto On Time</b>	<p>Enable to set the computer to turn on automatically every day or on a preselected date and time. This option can be configured only if the Auto On Time is set to Everyday, Weekdays, or Selected Days.</p> <p>By default, the <b>Auto On Time</b> option is disabled.</p>
<b>Intel AMT Capability</b>	<p>Enables, disables or manage Intel Active Management Technology capabilities.</p> <p>By default, the <b>Restrict Preboot Access</b> option is selected.</p>

**Table 39. BIOS Setup options—System Management menu (continued)**

<b>System Management</b>	
<b>First Power On Date</b>	
Set Ownership Date	Configures the ownership date. By default, the <b>Set Ownership Date</b> option is disabled.
<b>Diagnostics</b>	
OS Agent Requests	Enables or disables the capability of the Dell OS Agent from scheduling onboard diagnostics on a subsequent boot which can help assist in the prevention and resolution of hardware-related issues. By default, the <b>OS Agent Requests</b> option is enabled.
<b>Power-on-Self-Test Automatic Recovery</b>	Enable the computer to automatically recover it becomes unresponsive before completing the BIOS Power-on-Self-Test (POST). By default, the <b>Power-on-Self-Test Automatic Recovery</b> option is selected.

**Table 40. BIOS Setup option—Keyboard menu**

<b>Keyboard</b>	
<b>Fn Lock Options</b>	Enables or disables the Fn Lock option. By default, the <b>Fn Lock</b> option is enabled.
<b>Lock Mode</b>	By default, the <b>Lock Mode Secondary</b> option is enabled. With this option, the F1-F12 keys scan the code for their secondary functions.
<b>Keyboard Illumination</b>	Configures the operating mode of the keyboard illumination feature. By default, the <b>Bright</b> option is selected. Enables the keyboard illumination feature at 100% brightness level.
<b>Keyboard Backlight Timeout on AC</b>	Sets the timeout value for the keyboard backlight when an AC adapter is connected to the computer. By default, the <b>10 seconds</b> option is selected.
<b>Keyboard Backlight Timeout on Battery</b>	Sets the timeout value for the keyboard backlight when the computer is running only on the battery power. The keyboard backlight timeout value is only effective when the backlight is enabled. By default, the <b>10 seconds</b> option is selected.
<b>Device Configuration HotKey Access</b>	Allows you to control whether you can access device configuration screens through hotkeys during computer startup. By default, the <b>Device Configuration HotKey Access</b> option is enabled. <b>i NOTE:</b> This setting controls only the Intel RAID (CTRL+I), MEBX (CTRL+P), and LSI RAID (CTRL+C) Option ROMs. Other preboot Option ROMs, which support entry using a key sequence, are not affected by this setting.

**Table 41. BIOS Setup options—Pre-boot Behavior menu**

<b>Preboot Behavior</b>	
<b>Adapter Warnings</b>	
Enable Adapter Warnings	Enables the warning messages during boot when the adapters with less power capacity are detected. By default, the <b>Enable Dock Warning Messages</b> option is enabled.
<b>Warnings and Errors</b>	Enables or disables the action to be taken when a warning or error is encountered.

**Table 41. BIOS Setup options—Pre-boot Behavior menu (continued)**

Preboot Behavior	
	<p>By default, the <b>Prompt on Warnings and Errors</b> option is selected. Stop, prompt, and wait for user input when warnings or errors are detected.</p> <p> <b>NOTE:</b> Errors deemed critical to the operation of the computer hardware stop the functioning of the computer.</p>
<b>Extend BIOS POST Time</b>	<p>Sets the BIOS POST (Power-On Self-Test) load time.</p> <p>By default, the <b>0 seconds</b> option is selected.</p>
<b>MAC Address Pass-Through</b>	<p>Replaces the external NIC MAC address (in a supported dock or dongle) with the selected MAC address from the computer.</p> <p>By default, the <b>Passthrough MAC Address</b> option is selected.</p>
<b>Mouse/Touchpad</b>	<p>Defines how the computer handles mouse and touchpad input.</p> <p>By default, the <b>Touchpad and PS/2 Mouse</b> option is selected. Leaves the integrated touchpad enabled when an external PS/2 mouse is present.</p>
Sign of Life	
Early Logo Display	<p>Display Logo Sign of Life.</p> <p>By default, the <b>Early Logo Display</b> option is enabled.</p>
Early Keyboard Backlight	<p>Keyboard Backlight Sign of Life.</p> <p>By default, the <b>Early Keyboard Backlight</b> option is enabled.</p>

**Table 42. BIOS Setup options—Virtualization menu**

Virtualization Support	
Intel Virtualization Technology	
Enable Intel Virtualization Technology (VT)	<p>When enabled, the computer can run a Virtual Machine Monitor (VMM).</p> <p>By default, the <b>Enable Intel Virtualization Technology (VT)</b> option is enabled.</p>
VT for Direct I/O	
Enable Intel VT for Direct I/O	<p>When enabled, the computer can perform Virtualization Technology for Direct I/O (VT-d). VT-d is an Intel method that provides virtualization for memory map I/O.</p> <p>By default, the <b>Enable Intel VT for Direct I/O</b> option is disabled.</p>
<b>Intel Trusted Execution Technology (TXT)</b>	<p>Intel Trusted Execution Technology (TXT) is a set of hardware extensions to Intel processors and chipsets. It provides a hardware-based root of trust to ensure that a platform boots with a known good configuration of firmware, BIOS, virtual machine monitor, and operating system. The following must be enabled in order to enable Intel TXT -</p> <ul style="list-style-type: none"> <li>• Intel Virtualization Technology - X</li> <li>• Intel Virtualization Technology - Direct</li> </ul> <p>By default, the <b>Intel Trusted Execution Technology (TXT)</b> option is disabled.</p> <p>For additional security, Dell Technologies recommends keeping the <b>Intel Trusted Execution Technology (TXT)</b> option enabled.</p>
DMA Protection	
Enable Pre-Boot DMA Support	<p>Allows you to control the Pre-Boot DMA protection for both internal and external ports. This option does not directly enable DMA protection in the operating system.</p> <p> <b>NOTE:</b> This option is not available when the virtualization setting for IOMMU is disabled (VT-d/AMD Vi).</p>

**Table 42. BIOS Setup options—Virtualization menu (continued)**

<b>Virtualization Support</b>	
	<p>By default, the <b>Enable Pre-Boot DMA Support</b> option is enabled.</p> <p>For additional security, Dell Technologies recommends keeping the <b>Enable Pre-Boot DMA Support</b> option disabled.</p> <p><b>i</b> <b>NOTE:</b> This option is provided only for compatibility purposes, since some older hardware is not DMA capable.</p>
Enable OS Kernel DMA Support	<p>Allows you to control the Kernel DMA protection for both internal and external ports. This option does not directly enable DMA protection in the operating system. For operating systems that support DMA protection, this setting indicates to the operating system that the BIOS supports the feature.</p> <p><b>i</b> <b>NOTE:</b> This option is not available when the virtualization setting for IOMMU is disabled (VT-d/AMD Vi).</p> <p>By default, the <b>Enable OS Kernel DMA Support</b> option is disabled.</p> <p><b>i</b> <b>NOTE:</b> This option is provided only for compatibility purposes, since some older hardware is not DMA capable.</p>

**Table 43. System setup options—Performance menu**

<b>Performance</b>	
<b>Multi-Core Support</b>	
Multiple Atom Cores	<p>Enables to change the number of Atom cores available to the operating system. The default value is set to the maximum number of cores.</p> <p>By default, the <b>All Active</b> option is selected.</p>
<b>Intel SpeedStep</b>	
Enable Intel SpeedStep Technology	<p>Enables the computer to dynamically adjust processor voltage and core frequency, decreasing average power consumption and heat production.</p> <p>By default, the <b>Enable Intel SpeedStep Technology</b> option is enabled.</p>
<b>C-State Control</b>	
Enable C-State Control	<p>Enables or disables the ability of the CPU to enter and exit low-power state. When disabled, it disables all C-states. When enabled, it enables all C-states that the chipset or platform allows.</p> <p>By default, the <b>Enable C-State Control</b> option is enabled.</p>
<b>Enable Adaptive C-States for Discrete Graphics</b>	<p>Enables or disables the feature to dynamically detect high usage of a discrete graphics and automatically adjusts system parameters for higher performance.</p> <p>By default, the <b>Enable Adaptive C-States for Discrete Graphics</b> option is enabled.</p> <p><b>i</b> <b>NOTE:</b> The <b>Hybrid Graphics/Advanced Options</b> is applicable to computers shipped with integrated and discrete graphics controllers.</p>
<b>Intel Turbo Boost Technology</b>	
Enable Intel Turbo Boost Technology	<p>Enables the Intel TurboBoost mode of the processor. When enabled, the Intel TurboBoost driver increases the performance of the CPU or graphics processor.</p> <p>By default, the <b>Enable Intel Turbo Boost Technology</b> option is enabled.</p>
<b>Intel Hyper-Threading Technology</b>	
Enable Intel Hyper-Threading Technology	<p>Enables the Intel Hyper-Threading mode of the processor. When enabled, the Intel Hyper-Threading increases the efficiency of the processor resources when multiple threads run on each core.</p>

**Table 43. System setup options—Performance menu (continued)**

Performance	
	By default, the <b>Intel Hyper-Threading Technology</b> option is enabled.

**Table 44. BIOS Setup options—System Logs menu**

System Logs	
<b>BIOS Event Log</b>	
Clear BIOS Event Log	Allows you to select option to keep or clear BIOS events logs. By default, the <b>Keep Log</b> option is selected.
<b>Thermal Event Log</b>	
Clear Thermal Event Log	Allows you to select option to keep or clear Thermal events logs. By default, the <b>Keep Log</b> option is selected.
<b>Power Event Log</b>	
Clear Power Event Log	Allows you to select option to keep or clear Power events logs. By default, the <b>Keep Log</b> option is selected.

## Updating the BIOS

### Updating the BIOS in Windows

#### Steps

1. Go to [Dell Support Site](#).
2. Click **Product support**. In the **Search support** box, enter the Service Tag of your computer, and then click **Search**.  
 **NOTE:** If you do not have the Service Tag, use the SupportAssist feature to automatically identify your computer. You can also use the product ID or manually browse for your computer model.
3. Click **Drivers & Downloads**. Expand **Find drivers**.
4. Select the operating system installed on your computer.
5. In the **Category** drop-down list, select **BIOS**.
6. Select the latest version of BIOS, and click **Download** to download the BIOS file for your computer.
7. After the download is complete, browse the folder where you saved the BIOS update file.
8. Double-click the BIOS update file icon and follow the on-screen instructions.  
For more information about how to update the system BIOS, search in the Knowledge Base Resource at [Dell Support Site](#).

### Updating the BIOS using the USB drive in Windows

#### Steps

1. Follow the procedure from step 1 to step 6 in [Updating the BIOS in Windows](#) to download the latest BIOS Setup program file.
2. Create a bootable USB drive. For more information, search the Knowledge Base Resource at [Dell Support Site](#).
3. Copy the BIOS Setup program file to the bootable USB drive.
4. Connect the bootable USB drive to the computer that needs the BIOS update.
5. Restart the computer and press **F12**.
6. Select the USB drive from the **One Time Boot Menu**.
7. Type the BIOS Setup program filename and press **Enter**.



The **BIOS Update Utility** appears.

8. Follow the on-screen instructions to complete the BIOS update.

## Updating the BIOS from the F12 One Time Boot menu

Update your computer BIOS using the BIOS update.exe file that is copied to a FAT32 USB drive and booting from the F12 **One Time Boot** menu.

### About this task

#### BIOS Update

You can run the BIOS update file from Windows using a bootable USB drive or you can also update the BIOS from the F12 **One Time Boot** menu on the computer.

Most of the Dell computers built after 2012 have this capability, and you can confirm by booting your computer to the F12 **One Time Boot** Menu to see if BIOS FLASH UPDATE is listed as a boot option for your computer. If the option is listed, then the BIOS supports this BIOS update option.

 **NOTE:** Only computers with the BIOS Flash Update option in the F12 **One Time Boot** menu can use this function.

#### Updating from the One Time Boot menu

To update your BIOS from the F12 **One Time Boot** menu, you need the following:

- USB drive formatted to the FAT32 file system (key does not have to be bootable)
- BIOS executable file that you downloaded from the Dell Support website and copied to the root of the USB drive
- AC power adapter that is connected to the computer
- Functional computer battery to flash the BIOS

Perform the following steps to perform the BIOS update flash process from the F12 menu:

 **CAUTION:** Do not turn off the computer during the BIOS update process. The computer may not boot if you turn off your computer.

#### Steps

1. From a turn off state, insert the USB drive where you copied the flash into a USB port of the computer.
2. Turn on the computer and press F12 to access the **One Time Boot** Menu, select BIOS Update using the mouse or arrow keys then press Enter.  
The flash BIOS menu is displayed.
3. Click **Flash from file**.
4. Select an external USB device.
5. Select the file and double-click the flash target file, and then click **Submit**.
6. Click **Update BIOS**. The computer restarts to flash the BIOS.
7. The computer will restart after the BIOS update is completed.

## System and setup password

Table 45. System and setup password

Password type	Description
System password	Password that you must enter to log in to your system.
Setup password	Password that you must enter to access and make changes to the BIOS settings of your computer.

You can create a system password and a setup password to secure your computer.

 **CAUTION:** The password features provide a basic level of security for the data on your computer.

 **CAUTION:** Anyone can access the data that is stored on your computer, when not locked and left unattended.

 **NOTE:** System and setup password feature is disabled.

## Assigning a System Setup password

### Prerequisites

You can assign a new System or Admin Password only when the status is in **Not Set**.

### About this task

To enter BIOS System Setup, press F2 immediately after a power-on or reboot.

### Steps

1. In the **System BIOS** or **System Setup** screen, select **Security** and press Enter.  
The **Security** screen is visible.
2. Select **System/Admin Password** and create a password in the **Enter the new password** field.  
Use the following guidelines to assign the system password:
  - A password can have up to 32 characters.
  - At least one special character: "( ! " # \$ % & ' \* + , - . / : ; < = > ? @ [ \ ] ^ \_ ` { | } )"
  - Numbers 0 to 9.
  - Upper case letters from A to Z.
  - Lower case letters from a to z.
3. Type the system password that you entered earlier in the **Confirm new password** field and click **OK**.
4. Press Esc and save the changes as prompted by the message.
5. Press Y to save the changes.  
The computer restarts.

## Deleting or changing an existing system setup password

### Prerequisites

Ensure that the **Password Status** is Unlocked (in the System Setup) before attempting to delete or change the existing System and/or Setup password. You cannot delete or change an existing System or Setup password, if the **Password Status** is Locked.

### About this task

To enter the System Setup, press F2 immediately after a power-on or reboot.

### Steps

1. In the **System BIOS** or **System Setup** screen, select **System Security** and press Enter.  
The **System Security** screen is displayed.
2. In the **System Security** screen, verify that the Password Status is **Unlocked**.
3. Select **System Password**, update, or delete the existing system password, and press Enter or Tab.
4. Select **Setup Password**, update, or delete the existing setup password, and press Enter or Tab.  
 **NOTE:** If you change the System and/or Setup password, reenter the new password when prompted. If you delete the System and/or Setup password, confirm the deletion when prompted.
5. Press Esc. A message prompts you to save the changes.
6. Press Y to save the changes and exit from System Setup.  
The computer restarts.

# Clearing BIOS (System Setup) and System passwords

## About this task

To clear the computer or BIOS passwords, contact Dell technical support as described at [Contact Support](#). For more information, go to [Dell Support Site](#).

 **NOTE:** For information about how to reset Windows or application passwords, see the documentation accompanying Windows or your application.

# Troubleshooting

## Handling swollen rechargeable Li-ion batteries

Like most laptops, Dell laptops use Lithium-ion batteries. One type of Lithium-ion battery is the rechargeable Li-ion battery. Rechargeable Li-ion batteries have increased in popularity in recent years and have become standard in the electronics industry due to customer preferences for a slim form factor (especially with newer ultra-thin laptops) and long battery life. Inherent to rechargeable Li-ion battery technology is the potential for swelling of the battery cells.

A swollen battery may impact the performance of the laptop. To prevent possible further damage to the device enclosure or internal components leading to malfunction, discontinue the use of the laptop and discharge it by disconnecting the AC adapter and letting the battery drain.

Swollen batteries should not be used and should be replaced and disposed of properly. We recommend contacting Dell product support for options to replace a swollen battery under the terms of the applicable warranty or service contract, including options for replacement by a Dell authorized service technician.

The guidelines for handling and replacing rechargeable Li-ion batteries are as follows:

- Exercise caution when handling rechargeable Li-ion batteries.
- Discharge the battery before removing it from the system. To discharge the battery, unplug the AC adapter from the system and operate the system only on battery power. When the system will no longer turn on when the power button is pressed, the battery is fully discharged.
- Do not crush, drop, mutilate, or penetrate the battery with foreign objects.
- Do not expose the battery to high temperatures, or disassemble battery packs and cells.
- Do not apply pressure to the surface of the battery.
- Do not bend the battery.
- Do not use tools of any type to pry on or against the battery.
- If a battery gets stuck in a device as a result of swelling, do not try to free it as puncturing, bending, or crushing a battery can be dangerous.
- Do not attempt to reassemble a damaged or swollen battery into a laptop.
- Swollen batteries that are covered under warranty should be returned to Dell in an approved shipping container (provided by Dell)—this is to comply with transportation regulations. Swollen batteries that are not covered under warranty should be disposed of at an approved recycling center. Contact Dell product support at [Dell Support Site](#) for assistance and further instructions.
- Using a non-Dell or incompatible battery may increase the risk of fire or explosion. Replace the battery only with a compatible battery purchased from Dell that is designed to work with your Dell computer. Do not use a battery from other computers with your computer. Always purchase genuine batteries from [Dell Site](#) or otherwise directly from Dell.

Rechargeable Li-ion batteries can swell for various reasons such as age, number of charge cycles, or exposure to high heat. For more information about how to improve the performance and lifespan of the laptop battery and to minimize the possibility of occurrence of the issue, search Dell Laptop Battery in the Knowledge Base Resource at [Dell Support Site](#).

## Locate the Service Tag or Express Service Code of your Dell computer

Your Dell computer is uniquely identified with a Service Tag or Express Service Code. To view relevant support resources for your Dell computer, we recommend entering the Service Tag or Express Service Code at [Dell Support Site](#).

For more information about how to find the Service Tag for your computer, see [Instructions on how to find your Service Tag or Serial Number](#).

# Dell SupportAssist Pre-boot System Performance Check diagnostics

## About this task

SupportAssist diagnostics (also known as system diagnostics) performs a complete check of your hardware. The Dell SupportAssist Pre-boot System Performance Check diagnostics is embedded with the BIOS and launched by the BIOS internally. The embedded system diagnostics provides options for particular devices or device groups allowing you to:

- Run tests automatically or in an interactive mode.
- Repeat the tests.
- Display or save test results.
- Run thorough tests to introduce additional test options to provide extra information about one or more failed devices.
- View status messages that inform you the tests are completed successfully.
- View error messages that inform you of problems encountered during testing.

 **NOTE:** Some tests for specific devices require user interaction. Always ensure that you are present at the computer terminal when the diagnostic tests are performed.

For more information, see the knowledge base article [000180971](#).

## Running the SupportAssist Pre-Boot System Performance Check

### Steps

1. Turn on your computer.
2. As the computer boots, press the F12 key as the Dell logo appears.
3. On the boot menu screen, select the **Diagnostics** option.
4. Click the arrow at the bottom left corner.  
Diagnostics front page is displayed.
5. Click the arrow in the lower-right corner to go to the page listing.  
The items that are detected are listed.
6. To run a diagnostic test on a specific device, press Esc and click **Yes** to stop the diagnostic test.
7. Select the device from the left pane and click **Run Tests**.
8. If there are any issues, error codes are displayed.  
Note the error code and validation number and contact Dell.

## Built-in self-test (BIST)

### M-BIST

M-BIST (Built In Self-Test) is the system board built-in self-test diagnostics tool that improves the diagnostics accuracy of system board Embedded Controller (EC) failures.

 **NOTE:** M-BIST can be manually initiated before Power On Self-Test (POST).

### How to run M-BIST

 **NOTE:** M-BIST must be initiated on the computer from a power-off state that is either connected to AC power or with a battery only.

1. Press and hold both the **M** key on the keyboard and the **power button** to initiate M-BIST.
2. The battery indicator LED may exhibit two states:
  - a. OFF: No fault was detected with the system board.
  - b. AMBER: Amber indicates a problem with the system board.

- If there is a failure with the system board, the battery status LED flashes one of the following error codes for 30 seconds:

**Table 46. LED error codes**

Blinking Pattern		Possible Problem
Amber	White	
2	1	CPU Failure
2	8	LCD Power Rail Failure
1	1	TPM Detection Failure
2	4	Memory/RAM failure

- If there is no failure with the system board, the LCD cycles through the solid color screens that are described in the LCD-BIST section for 30 seconds and then turn off.

## LCD Power rail test (L-BIST)

L-BIST is an enhancement to the single LED error code diagnostics and is automatically initiated during POST. L-BIST will check the LCD power rail. If there is no power being supplied to the LCD (that is if the L-BIST circuit fails), the battery status LED flashes either an error code [2,8] or an error code [2,7].

**NOTE:** If L-BIST fails, LCD-BIST cannot function as no power will be supplied to the LCD.

### How to invoke the L-BIST Test

- Press the power button to start the computer.
- If the computer does not start up normally, look at the battery status LED:
  - If the battery status LED flashes an error code [2,7], the display cable may not be connected properly.
  - If the battery status LED flashes an error code [2,8], there is a failure on the LCD power rail of the system board, hence there is no power that is supplied to the LCD.
- For cases, when a [2,7] error code is shown, check to see if the display cable is properly connected.
- For cases when a [2,8] error code is shown, replace the system board.

## LCD Built-in Self-Test (BIST)

Dell laptops have a built-in diagnostic tool that helps you determine if the screen abnormality you are experiencing is an inherent problem with the LCD (screen) of the Dell laptop or with the video card (GPU) and computer settings.

When you notice screen abnormalities like flickering, distortion, clarity issues, fuzzy or blurry image, horizontal or vertical lines, color fade and so on, it is always a good practice to isolate the LCD (screen) by running the Built-In Self-Test (BIST).

### How to invoke the LCD BIST Test

- Power off the Dell laptop.
- Disconnect any peripherals that are connected to the laptop. Connect only the AC adapter (charger) to the laptop.
- Ensure that the LCD (screen) is clean (no dust particles on the surface of the screen).
- Press and hold the **D** key and **Power on** the laptop to enter LCD built-in self-test (BIST) mode. Continue to hold the D key until the computer boots up.
- The screen displays solid colors and change colors on the entire screen to white, black, red, green, and blue twice.
- Then it displays the colors white, black, and red.
- Carefully inspect the screen for abnormalities (any lines, fuzzy color, or distortion on the screen).
- At the end of the last solid color (red), the computer shuts down.

**NOTE:** Dell SupportAssist Preboot diagnostics upon launch initiates an LCD BIST first, expecting a user intervention to confirm functionality of the LCD.

# System-diagnostic lights

This section lists the system-diagnostic lights of your XPS 16 9640.

**Table 47. System-diagnostic lights**

Blinking pattern		Problem description
Amber	White	
1	1	TPM detection failure
1	2	Unrecoverable SPI Flash Failure
1	5	EC unable to program i-Fuse
1	6	Generic catch-all for ungraceful EC code flow errors
2	1	CPU failure
2	2	System board failure (included BIOS corruption or ROM error)
2	3	No memory or RAM detected
2	4	Memory or RAM failure
2	5	Invalid memory installed
2	6	System board or Chipset Error
2	7	LCD failure (SBIOS message)
2	8	LCD failure (EC detection of power rail failure)
3	1	CMOS battery failure
3	2	PCI or Video card or chip failure
3	3	BIOS Recovery image not found
3	4	BIOS Recovery image found but invalid
3	5	Power rail failure
3	6	Flash corruption is detected by SBIOS.
3	7	Timeout waiting on ME to reply to HECI message.

**NOTE:** Blinking 3-3-3 LEDs on Lock LED (Caps-Lock or Num-Lock), Power button LED (without Fingerprint reader), and Diagnostic LED indicates failure to provide input during LCD panel test on Dell SupportAssist Pre-boot System Performance Check diagnostics.

## Recovering the operating system

When your computer is unable to boot to the operating system even after repeated attempts, it automatically starts Dell SupportAssist OS Recovery.

Dell SupportAssist OS Recovery is a stand-alone tool that is preinstalled in all Dell computers that are installed with the Windows operating system. It consists of tools to diagnose and troubleshoot issues that may occur before your computer boots to the operating system. It enables you to diagnose hardware issues, repair your computer, back up your files, or restore your computer to its factory state.

You can also download it from the Dell Support website to troubleshoot and fix your computer when it fails to boot into their primary operating system due to software or hardware failures.

For more information about the Dell SupportAssist OS Recovery, see *Dell SupportAssist OS Recovery User's Guide* at [Serviceability Tools at the Dell Support Site](#). Click **SupportAssist** and then, click **SupportAssist OS Recovery**.

## Real-Time Clock (RTC Reset)

The Real Time Clock (RTC) reset function allows you or the service technician to recover Dell computers from No POST/No Power/No Boot situations. The legacy jumper enabled RTC reset has been retired on these models.

Start the RTC reset with the computer powered off and connected to AC power. Press and hold the power button for thirty (30) seconds. The computer RTC Reset occurs after you release the power button.

## Backup media and recovery options

It is recommended to create a recovery drive to troubleshoot and fix problems that may occur with Windows. Dell proposes multiple options for recovering the Windows operating system on your Dell computer. For more information, see [Dell Windows Backup Media and Recovery Options](#).

## Wi-Fi power cycle

### About this task

If your computer is unable to access the Internet due to Wi-Fi connectivity issues a Wi-Fi power cycle procedure may be performed. The following procedure provides the instructions on how to conduct a Wi-Fi power cycle:

 **NOTE:** Some Internet Service Providers (ISPs) provide a modem or router combo device.

### Steps

1. Turn off your computer.
2. Turn off the modem.
3. Turn off the wireless router.
4. Wait for 30 seconds.
5. Turn on the wireless router.
6. Turn on the modem.
7. Turn on your computer.

## Drain residual flea power (perform hard reset)

### About this task

Flea power is the residual static electricity that remains in the computer even after it has been powered off and the battery is removed.

For your safety, and to protect the sensitive electronic components in your computer, you are requested to drain residual flea power before removing or replacing any components in your computer.

Draining residual flea power, also known as a performing a "hard reset," is also a common troubleshooting step if your computer does not turn on or boot into the operating system.

Perform the following steps to drain the residual flea power:

### Steps

1. Turn off your computer.
2. Disconnect the power adapter from your computer.
3. Remove the base cover.
4. Remove the battery.



 **CAUTION:** The battery is a Field Replaceable Unit (FRU) and the removal/installation is intended for authorized service technicians only.

5. Press and hold the power button for 20 seconds to drain the flea power.
6. Install the battery.
7. Install the base cover.
8. Connect the power adapter to your computer.
9. Turn on your computer.



 **NOTE:** For more information about performing a hard reset, search in the Knowledge Base Resource at [Dell Support Site](#).

# Getting help and contacting Dell Technologies

## Self-help resources

You can get information and help on Dell Technologies products and services using these self-help resources:

**Table 48. Self-help resources**

Self-help resources	Resource location
Information about Dell Technologies products and services	<a href="#">Dell Site</a>
My Dell app	
Tips	
Contact Support	In Windows search, type <code>Contact Support</code> , and press Enter.
Online help for operating system	<a href="#">Windows Support Site</a>
Access top solutions, diagnostics, drivers and downloads, and learn more about your computer through videos, manuals, and documents.	Your Dell Technologies computer is uniquely identified using a Service Tag or Express Service Code. To view relevant support resources for your Dell Technologies computer, enter the Service Tag or Express Service Code at <a href="#">Dell Support Site</a> . For more information about how to find the Service Tag for your computer, see <a href="#">Instructions on how to find your Service Tag or Serial Number</a> .
Dell Technologies knowledge base articles	<ol style="list-style-type: none"> <li>1. Go to <a href="#">Dell Support Site</a>.</li> <li>2. On the menu bar at the top of the Support page, select <b>Support &gt; Support Library</b>.</li> <li>3. In the Search field on the Support Library page, type the keyword, topic, or model number, and then click or tap the search icon to view the related articles.</li> </ol>

## Contacting Dell Technologies

To contact Dell Technologies for sales, technical support, or customer service issues, see [Contact Support at Dell Support Site](#).

 **NOTE:** Availability of the services may vary depending on the country or region, and product.

 **NOTE:** If you do not have an active Internet connection, you can find contact information about your purchase invoice, packing slip, bill, or Dell Technologies product catalog.