

ECS9691G  
ECS6691G

EN Cooker hood

User Manual

2

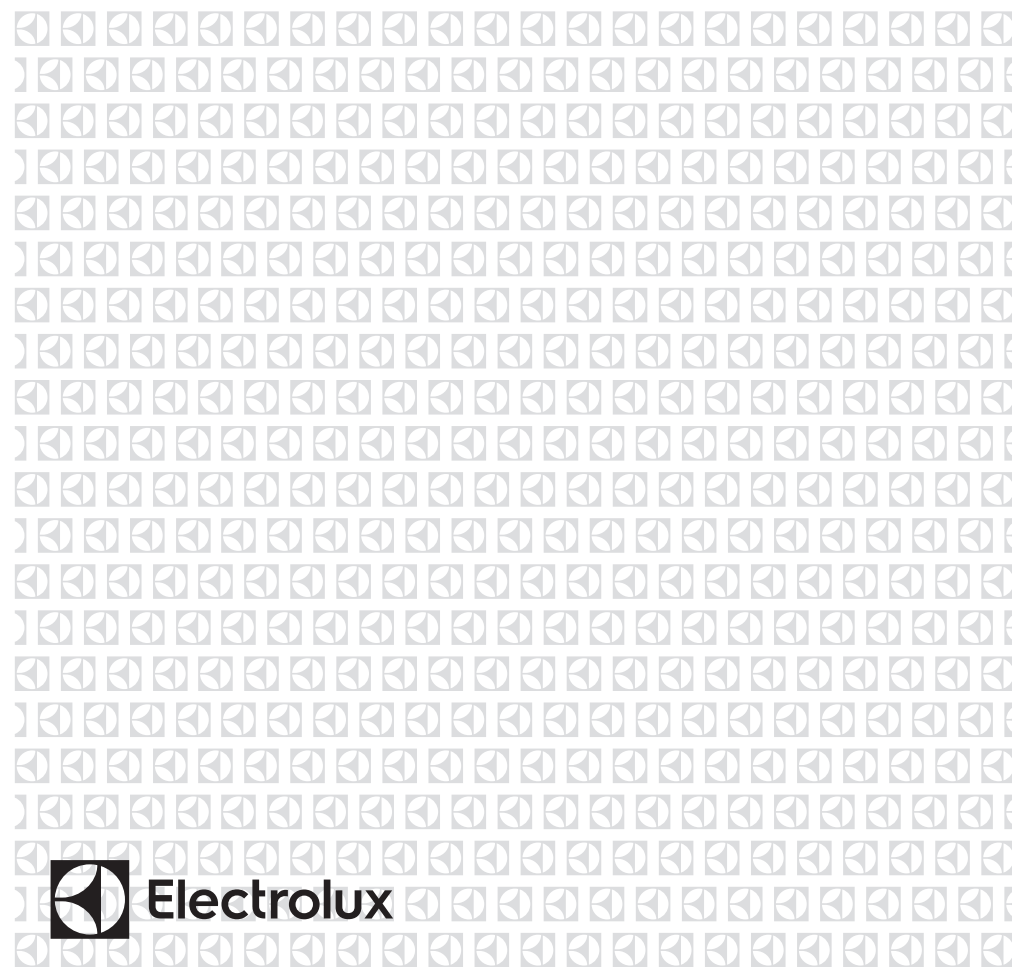
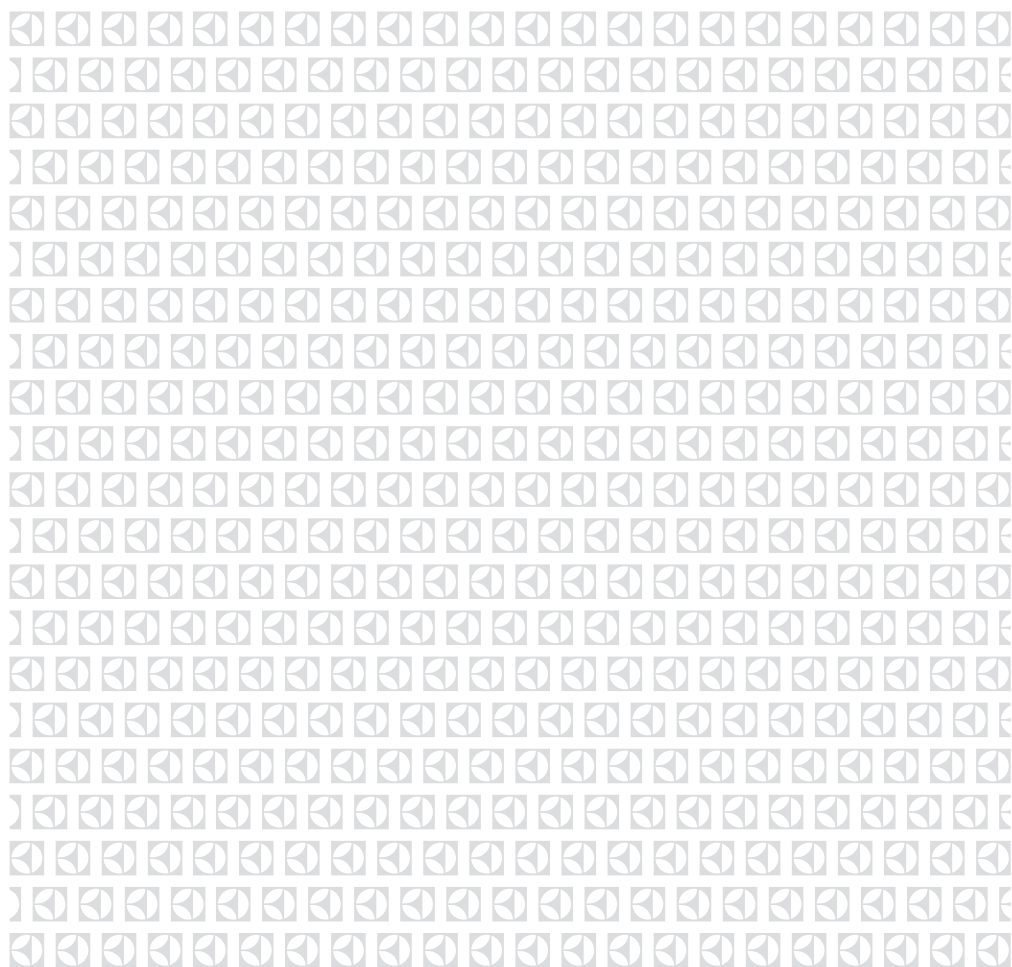

WE'RE THINKING OF YOU

Thank you for purchasing an Electrolux appliance. You've chosen a product that brings with it decades of professional experience and innovation. Ingenious and stylish, it has been designed with you in mind. So whenever you use it, you can be safe in the knowledge that you'll get great results every time. Welcome to Electrolux.

BEFORE USING YOUR APPLIANCE

Before you use the rangehood, we recommend that you read through the whole user manual which provides the description of the rangehood and its functions. To avoid the risks that are always present when you use an electrical appliance, it is important that the rangehood is installed correctly and that you read the safety instructions carefully to avoid misuse and hazards.

For future reference, please store this booklet in a safe place.

CONDITIONS OF USE

This appliance is intended to be used in household and similar applications such as

- Staff kitchen areas in shops, offices and other working environments
- Farm houses
- By clients in hotels, motels and other residential type environments
- Bed and breakfast type environments

BEFORE YOU CALL

Please ensure you read the instruction manual fully before you call for service, or a full service fee could be applicable.

RECORD MODEL AND SERIAL NUMBER HERE:

Model: \_\_\_\_\_

Serial NO: \_\_\_\_\_

CONTENTS

- 3 Safety information
- 4 Product description
- 5 Dimensions
- 6 Rangehood installation
- 8 Using the rangehood
- 9 Maintenance and cleaning
- 10 Troubleshooting
- 11 Consumer Care Center

LEGEND

**! WARNING!**  
This symbol indicates information concerning your personal safety

**! CAUTIONS!**  
This symbol indicates information on how to avoid damaging the rangehood.

**i IMPORTANT!**  
This symbol indicates tips and information about use of the rangehood.

**🌱 ENVIRONMENT!**  
This symbol indicates tips and information about economical and ecological use of the rangehood.

**RoHS Compliant.**

If at any time in future you need to dispose of this product please do Not dispose of this product with household waste, please send this product to collecting points where available

**This product is RoHS compliant.**

SAFETY INFORMATION

This manual explains the proper use of your new Electrolux canopy rangehood. Please read this manual carefully before using the product. This manual should be kept in a safe place for handy reference.

This rangehood is a domestic appliance which has been manufactured and tested to comply with International Standard IEC 60335.2.31.

Read the following carefully to avoid damage or injury.

- ⊘ This symbol indicates never to do this
- ⊙ This symbol indicates always do this

**! WARNING!**  
Follow these instructions carefully to avoid an electric shock or fire.

- ⊙ Young children should be supervised to ensure they do not play with the rangehood.
- ⊘ This appliance is not intended for use by persons (including children) with reduced physical, sensory or mental capabilities, or lack of experience and knowledge, unless they have been given supervision or instruction concerning the use of the appliance by a person responsible for their safety.
- ⊙ Ensure the rangehood is switched off before carrying out maintenance, to avoid any possibility of electric shock.
- ⊘ Never carry out flambe cooking under the rangehood.
- ⊘ This rangehood is not recommended for barbecues.
- ⊘ This rangehood cannot be installed for external use.
- ⊙ Grease filters must be removed every four weeks (maximum) for cleaning to reduce the risk of fire.
- ⊘ The exhaust from the rangehood must not be discharged into any heating flue, which may carry combustion products from other sources.(Fig.1)
- ⊘ The exhaust air must not be discharged into a wall cavity, unless the cavity is designed for the purpose.
- ⊙ There must be adequate ventilation of the room when the rangehood is used at the same time as appliances burning gas or other fuels.
- ⊙ Always cover lit gas burners with pots or pans when rangehood is in use.
- ⊙ Always switch off gas burners before you remove pots or pans.
- ⊘ Do not leave lit gas burners exposed due to the risk of fire.(Fig.2)

**Electrical connection**

Check that the mains voltage matches with the voltage on the data plate inside the rangehood. Check that the installation complies with standards of local building, gas and electrical authorities. Before connecting to the mains supply ensure that the mains voltage corresponds to the voltage on the rating plate inside the rangehood. If the supply cord is damaged, it must be replaced by the manufacturer or its service agent or similarly qualified person in order to avoid a hazard.

**Safety warnings For the installer**

When installing the rangehood, make sure you adhere to the minimum and maximum distances from the rangehood base to the hob surface (as per table on page 6).

**Exhaust flue installation:** The following rules must be strictly followed to obtain optimal air extraction.

- Keep exhaust flue short and straight
- Do not reduce the size or restrict exhaust flue.
- Keep bends in the exhaust flue to a minimum.
- When using flexible flue always install duct with helix pulled taut to minimise pressure loss.
- Failure to observe these basic instructions will drastically reduce the performance and increase the noise levels of the range hood.

Exhaust air must not be discharged into a wall cavity, unless the cavity is designed for the purpose. The exhaust from the cooker hood must not be discharged into any heating flue, which may carry combustion products from other sources.

*NOTE: Some installations may require the telescopic exhaust cover to be cut to length. Cut with sharp tin snips or a fine-tooth hack saw blade, taking care not to distort or dent the exhaust cover.*

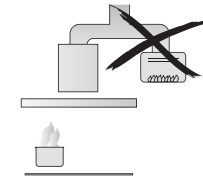

Fig. 1

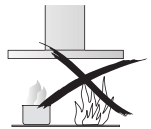

Fig. 2

PRODUCT DESCRIPTION

ECS9691G  
ECS6691G

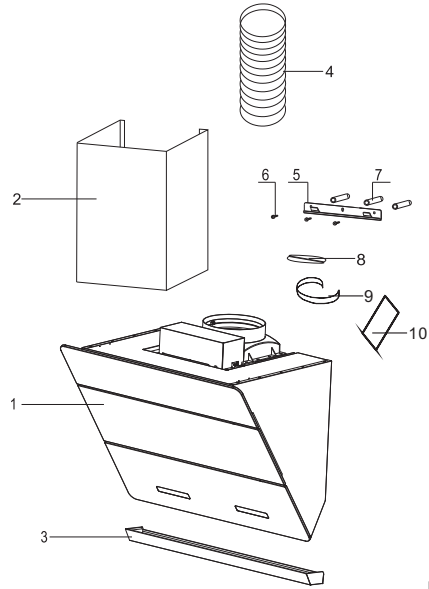

Fig.3

COMPONENTS

| Ref | Q'ty | Product Components                                 |
|-----|------|--|
| 1   | 1pc  | Hood body, complete with: controls, lights, blower |
| 2   | 1pc  | Chimney  |
| 3   | 1pc  | Oil cup  |
| 4   | 1pc  | Aluminum pipe                                      |
| 5   | 1pc  | Hood mounting bracket                              |
| 6   | 5pcs | Mounting screws(ST 5X 50MM)                        |
| 7   | 5pcs | Drywall Anchors                                    |
| 8   | 1set | <b>Damper</b>                                      |
| 9   | 1pc  | Duct fixing tape                                   |
| 10  | 1pc  | User manual  |

Fig.3

DIMENSIONS

ECS9691G  
ECS6691G

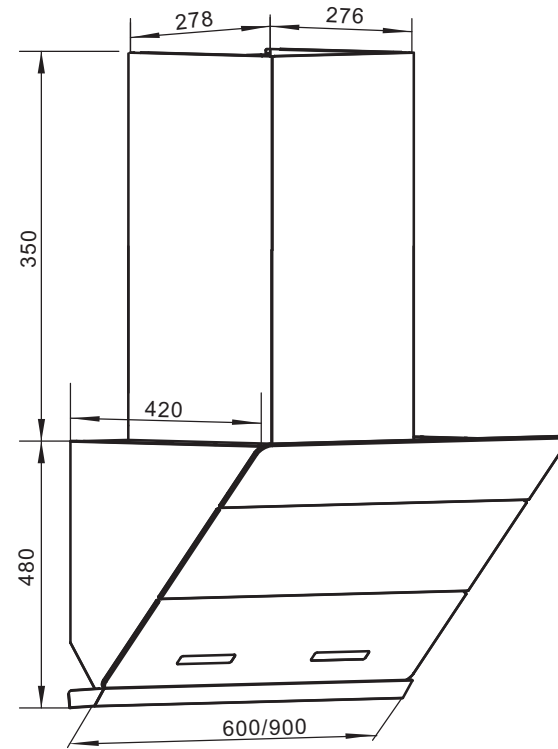

Fig.4

RANGEHOOD INSATLLATION

**! WARNING!**

Refer to "Safety information" chapter

**i BEFORE INSTALLATION**

Before the installation of the appliance, record the information below from the rating plate. The rating plate is on the bottom of the appliance casing.

Model \_\_\_\_\_  
 PNC \_\_\_\_\_  
 Serial number \_\_\_\_\_

- Using a spirit level mark a vertical centre line on the wall where the cooker hood is to be positioned, and a horizontal line at the cooker hood base position (refer diagram below).

*NOTE: The height of the underside of the hood body must be a minimum of 650mm\* to a maximum height of 800mm*

\* If the instructions of the hob specify a greater distance than the minimum above, then that shall be the minimum height for installation.

Mark the location for cooker hood mounting points above the hood base as the reference point (Fig.5).

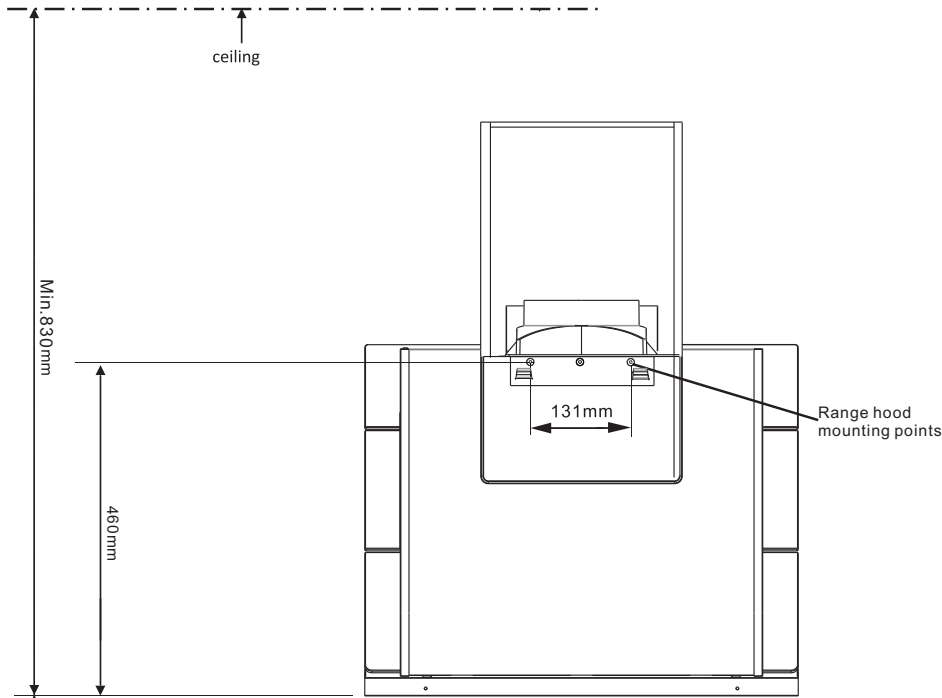

| Cooktop type | DIM.A    |         |
|--------------|----------|---------|
|              | minimum* | maximum |
| Gas          | 700mm    | 800mm   |
| Electric     | 650mm    | 800mm   |

**! WARNING!**

Failure to install the screws or fixing device in accordance with these instructions may result in electrical hazards

Top of hob Fig.5

RANGEHOOD INSATLLATION

- Install the wall bracket with screws to the wall as marked (Fig.6).

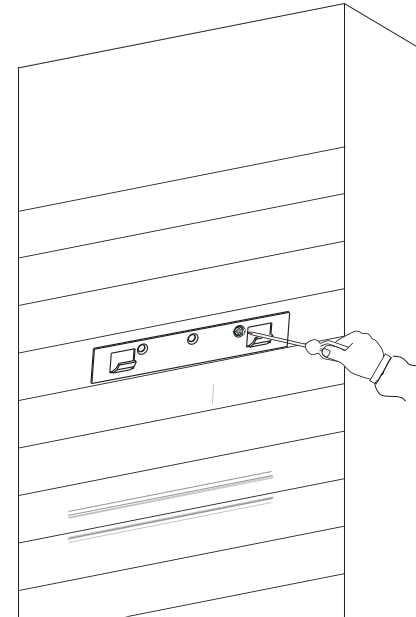

Fig.6

- Hang the hood on the wall bracket (Fig.7).

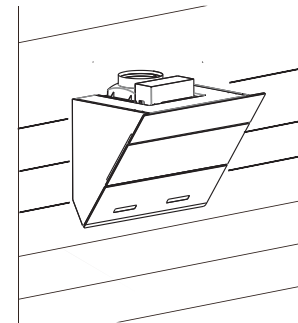

Fig.7

- Fit the flexible flue to the duct transition (Fig.8). Use fixing tapes to secure flexible pipe to the duct transition.

*NOTE: For ducted mode, we recommend extending flue pipe through the roof to external "roof cap" to vent exhaust externally. We do not recommend venting into ceiling cavity.*

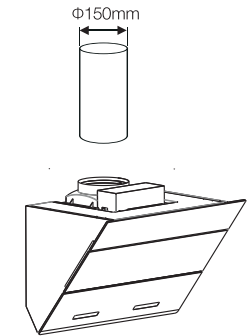

Fig.8

**6. Electrical connection**

- Electrical wiring must be done by a qualified person(s) in accordance with all applicable codes and standards. Turn off electrical power at service entrance before wiring.
- If the power cord is damaged, it must be replaced by manufacturer, its agent or similarly qualified persons in order to avoid hazard.
- Do not use the plug and an extension cord other than the ones initially supplied with the hoods.
- The earthing of this hood is compulsory. Do not remove the ground prong of the plug.

## 7. Installation of telescopic flue covers (Fig.9)

Assemble the flue cover onto the hood body make sure it on the correct position.

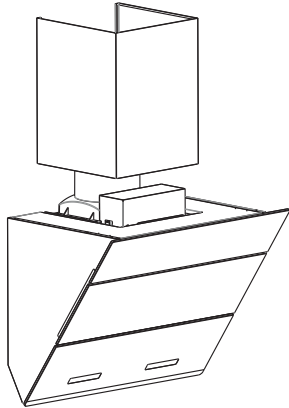
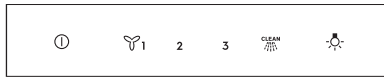

Fig.9

## USING THE RANGEHOOD



### Fan – select speed to suit cooking conditions

- ① – Fan on/off
- ☹️ – light frying/boiling
- 2 – frying/work cooking/heavy boiling
- 3 – grilling, intensive frying and work cooking
- CLEAN – Self-clean
- 💡 – Light

### Self-clean instruction

This product is equipped with self-clean technology.

The self-clean icon will start glowing after the motor works for 15 hours. User can tap the self-clean button to activate the self-clean function.

The red indicator will start glowing during the cleaning process.

The time period for Self-clean is 10 to 15 minutes. The product can be used during self-clean.

Your Electrolux rangehood is now ready to use

## MAINTENANCE AND CLEANING

### ⚠️ CAUTION!

- Before maintenance or cleaning is carried out, the rangehood should be disconnected from the main power supply. Ensure that the rangehood is switched off at the wall socket and the plug removed if fitted.
- External surface are susceptible to scratches and abrasions, so please follow the cleaning instructions to ensure the best possible result is achieved without damage.
- These instructions must be followed to avoid a fire risk.

### Glass

- Glass should be cleaned every week in order to keep the shiny

### Grease filter

- The grease filter should be cleaned frequently ( every two months of operation, or more frequently for heavy use). Use a warm detergent solution.
- Grease filter is washable
- Remove the grease filter by unscrewing the screw on the rotation support and releasing the glass panel from two hinges. Tilt the filter downward and remove (Fig.10)
- Wash the filter, taking care not to bend them. Allow them to be dried before refitting.
- To install the grease filter, push filter into position and release. Fix the glass panel to the two hinges and refix one screw.

*Note: To replace the filter, please let the hood on suction mode before cutting off the electrical supplier and don't open the glass panel by hand.*

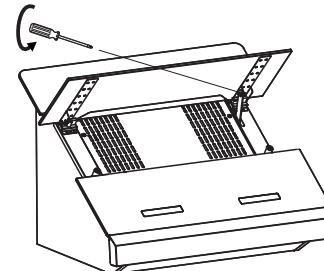

Fig.10

### Replacing the lamp

Dismantle the lower glass by removing the two rubber columns and unscrewing the two screws on glass (Fig.11).

Replace the damaged LED, only use LED DC 12V,2W Max

#### Note:

1. To replace the LED, please let the hood on suction mode before cutting off the electrical supplier and don't open the glass panel by hand.
2. We recommend only using lamps of the same specification as the ones being replaced.

#### WARNING: .

1. Always switch off the electrical supply before carrying out any operation on the appliance.
2. Only a qualified and trained service technician can undertake the work of bulbs replacement and servicing.

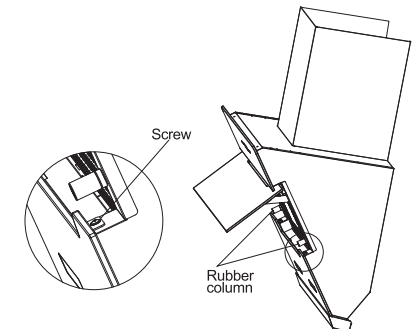

Fig.11

### Changing the lamp

Lamps are long life LED lamps and should not require service. If there is an issue with lamp please contact the Service Center.

## TROUBLESHOOTING

| Problem   | Remedy   |
|---|--|
| The cooker hood will not start                  | Check that the hood is connected to an electrical supply<br>Check that a fan speed has been selected   |
| The Rangehood is not working                    | Check that the fan speed is set high enough for the task<br>The grease filters are clean<br>The kitchen is adequately vented to allow the entry of fresh air<br>If set up for recirculation, check that the charcoal filter is still effective<br>If set up for extraction, check that the duct and outlets are not blocked<br>Do not operate cooktop without pots/pans<br>Do not flambe under cooktop |
| The rangehood has switched off during operation | If the hood has been installed below the heights indicated in the installation instructions the motor will cut out frequently which will damage the hood   |

If you have completed all the above checks and are still experiencing difficulty, please contact your local Electrolux Service Centre.

*Note: This product is fitted with a safety cutout device.*

- If the rangehood is installed too close to the cooker top, flambe cooking, operating the cooktop without cooking utensils and blocked filters may activate the safety cutout device. If the hood stops during operation, correct the faults and allow time for the safety cutout device to reset. Then the rangehood will function correctly.

- Do not operate cooktop without pots/pans
- Do not flambe under cooktop

## CONSUMER CARE CENTER

|   |   |
|---|---|
| <p>Thailand<br/>Consumer Care Tel : (+66 2) 725 9000<br/>Electrolux Thailand Co., Ltd.<br/>Electrolux Building 14th Floor<br/>1910 New Phetchaburi Road,<br/>Bangkapi, Huai Khwang, Bangkok 10310<br/>Office Tel : (+66 2) 7259100<br/>Office Fax : (+66 2) 7259299<br/>Email : customercarethai@electrolux.com</p> | <p>Singapore<br/>Consumer Care Center Tel: (+65) 6727 3699<br/>Electrolux S.E.A. Pte Ltd.<br/>351 Braddell Road<br/>#01-04, 351 On Braddell<br/>Singapore 579713<br/>Email : customer-care.sin@electrolux.com</p>   |
| <p>Indonesia<br/>Hotline service: 08041119999<br/>PT. Electrolux Indonesia<br/>Electrolux Building<br/>Jl.Abdul Muis No.34, Petojo Selatan,<br/>Gambir Jakarta Pusat 10160<br/>Email:customercare@electrolux.co.id<br/>SMS &amp; WA : 0812.8088.8863</p>  | <p>Philippines<br/>Consumer Care Center Toll Free:<br/>1-800-10-845-CARE(2273)<br/>Consumer Care Hotline:(+63 2)845-CARE(2273)<br/>Electrolux Philippines, Inc.<br/>Unit B 12F Cyber Sigma Bldg, Lawton Avenue,<br/>McKinley West, Taguig, Philippines 1634<br/>Trunkline:+63 2 737-4757<br/>Website:www.electrolux.com.ph<br/>Email:wecare@electrolux.com</p>  |
| <p>Vietnam<br/>Consumer Care Center Toll Free<br/>1800-58-88-99<br/>Tel: (+84 28) 39105465<br/>Electrolux Vietnam Ltd.<br/>Unit 1&amp;2, 10F Sofic Tower, #10 Mai Chi Tho<br/>Street,<br/>Thu Thiem Ward, Thu Duc City, Ho Chi<br/>Minh City, Vietnam</p>   | <p>Malaysia<br/>Consumer Care Center Tel: 1300-88-11-22<br/>Electrolux Home Appliances Sdn. Bhd.<br/>Corporate Office Address: Unit T2-7, 7th Floor,<br/>Tower 2, PJ33, No. 3, Jalan Semangat,<br/>Seksyen 13, 46200 Petaling Jaya, Selangor.<br/>Office Tel : (+60 3) 7843 5999<br/>Office Fax : (+60 3) 7955 5511<br/>Consumer Care Center Address: Lot C6, No. 28,<br/>Jalan 15/22, Taman Perindustrian Tiong Nam,<br/>40200 Shah Alam, Selangor<br/>Consumer Care Center Fax : (+60 3) 5524 2521<br/>Email : malaysia.customercare@electrolux.com</p> |
| <p>HONG KONG<br/>SERVICE HOTLINE: (+852) 3193 9888<br/>DCH ELECTRICAL APPLIANCES<br/>SERVICE CENTRE<br/>4/F, DCH BUILDING, 20 KAI CHEUNG<br/>ROAD,<br/>KOWLOON BAY, HONG KONG<br/>EMAIL: customercare@dch.com.hk<br/>WEBSITE: www.electrolux.com.hk</p>   |   |

**[www.electrolux.com](http://www.electrolux.com)**

**The Thoughtful Design Innovator.**

Do you remember the last time you opened a gift that made you say, "Oh! How did you know? That's exactly what I wanted!" That's the kind of feeling that we at Electrolux seek to evoke in everyone who chooses or uses one of our products. We devote time, knowledge, and a great deal of thought to anticipating and creating the kind of appliances that our customers really need and want.

This kind of thoughtful care means innovating with insight. Not design for design's sake, but design for the user's sake. For us, thoughtful design means making appliances easier to use and tasks more enjoyable to perform, freeing our customers to experience the ultimate 21st century luxury: ease of mind. Our aim is to make this ease of mind more available to more people in more parts of their everyday lives, all over the world.

The "Thinking of you" promise from Electrolux goes beyond meeting the needs of today's consumers. It also means we're committed to making appliances safe for the environment—now and for future generations.

Electrolux. Thinking of you.

Share more of our thinking at  
**[www.electrolux.com](http://www.electrolux.com)**