



A **HAVELLS** Brand

— SPLIT AIR CONDITIONER —

OWNER'S MANUAL

HELLO!
FROM ME & MY BETTER HALF.

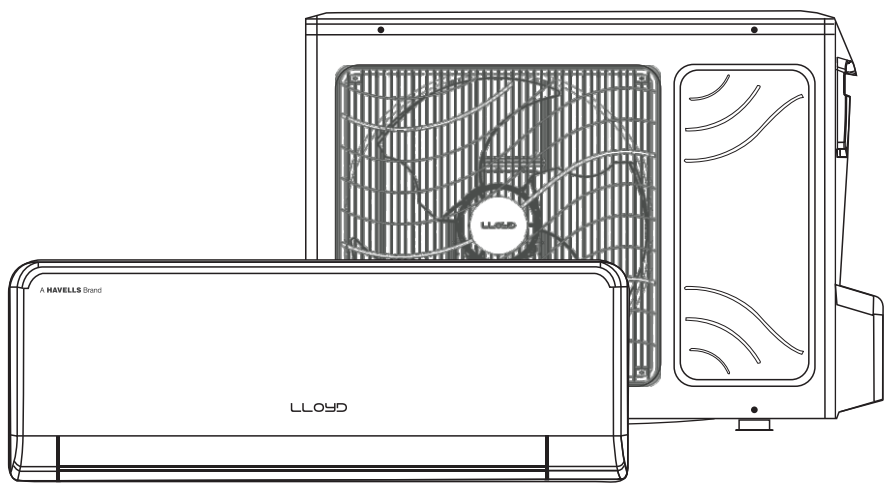

Please read this owners manual carefully before operating the appliance and keep it handy for reference for all the time.

KSLSLHAX0041- Ver- 2.0

Dear Customer,

Congratulations on being the proud owner of Lloyd Air conditioner.
Your Air conditioner comes with the Lloyd Guarantee of Quality.

Lloyd takes great pride in providing its customers with perfect products those adhere to international quality standards.

Lloyd is committed to provide the ultimate customer satisfaction and the Company takes great pride in having satisfied customers.

At Lloyd, feedback and suggestions based on your product usage are greatly appreciated.

Please feel free to contact us at:
customercare@havells.com

TEAM LLOYD

Content Page

E-Waste Disposal.....	1
Precautions	2
Installation.....	2
Operation and maintenance.....	3
Service and Repair	3
Caution for using R32 refrigerant.....	4
Part Name.....	6
Outdoor Unit-Indoor Unit.....	6
Indoor Unit Information.....	7
Hidden Display Indication Information.....	7
Side Display and Indication Information.....	8
Remote Handset & Button Information.....	9
Remote Handset LCD Information.....	10
Operation Guide.....	11
PM _{2.5}	34
Zone wise color Indication.....	36
Intelligent Diagnostic.....	37
AQI.....	39
ODVA module operation.....	44
Errors & Troubleshooting.....	48
Replacement of Batteries in remote Control.....	49
Emergency Operation.....	50
Clean and Maintenance.....	51
Malfunction analysis.....	53
Installation Dimension Diagram.....	56
Toll for Installation.....	57
Selection of Installation Location.....	57
Requirement for Electric Connection.....	58
Installation of Indoor Unit.....	59
Installation of Outdoor Unit.....	64
Vacuumping Pumping.....	67
Leakage Detection.....	67
Check After Installation.....	68
Configuration of Connection Pipe.....	69
Pipe Expanding Method.....	70
Warranty.....	72
Warranty Registration Card.....	74

Explanation of Symbols



Indicates a hazardous situation that, if not avoided, will result in death or serious injury.



Indicates a hazardous situation that, if not avoided, could result in death or serious injury.



Indicates a hazardous situation that, if not avoided, may result in minor or moderate injury.



Indicates important but not hazard-related information, used to indicate risk of property damage.



Indicates a hazard that would be assigned a signal word WARNING or CAUTION.



Do not mix the electronic waste with solid waste



This image indicates the information has to be read carefully.

E-Waste Disposal

Environmental Compliances:

As per the rules laid down by the Government for environmental concern & safety, your product has been made to comply and conform to the respective regulation as listed below. This product falls under the E-Waste (Management) Rules, 2022 with all amendments of Ministry of Environment, Forest & Climate Change.

RoHS"Declaration"-This Product is in conformity with requirements of Rule 16 of the E-Waste (Management) Rules, 2022 with all amendments. The content of hazardous substances with the exemption of the applications listed in SCHEDULE II of the E-Waste (Management) Rules, 2022 is as follows:

1. **Lead (Pb): not over 0.1 % by weight;**
2. **Mercury(Hg): not over 0.1 % by weight;**
3. **Cadmium(Cd): not over 0.01 % by weight;**
4. **Hexavalent Chromium (Cr6+): not over 0.1 % by weight;**
5. **Polybrominated Biphenyls (PBBs): not over 0.1 % by weight;**
6. **Polybrominated Diphenyl Ethers (PBDEs): not over 0.1 % by weight.**

E-Waste Disposal

Do's and Don'ts for disposal of product :

1.) Do's :

- a) Always drop your used electrical/electronic products, defective spares or any accessories and packaging materials after the end of their life at the nearest authorized collection point/center.
- b) Make sure that your electronic products are recycled only by authorized recyclers /dismantlers.
- c) Segregate the packaging materials according to their respective waste disposal options and sorting for recycling.
- d) Protect the glass surface of any electronic product to avoid breakage.

2.) Don'ts :

- a) Never dismantle your electronic product yourself.
- b) Never sell off E-Waste to informal and unorganized sectors like local scrap dealer/rag pickers.
- c) Never dump E-Waste in garbage bins or municipal solid waste stream.
- d) Do not dispose your product as unsorted municipal waste.

For more information on safe disposal, recycling and collection point, please call customer care number 0804-577-5666 or visit our website <https://www.mylloyd.com/aboutus/social-initiatives> and <https://www.havells.com/en/discover-havells/wasteawareness.html> or write a mail to ewaste@havells.com

Precautions



WARNING

1. Installation

- Installation must be performed by qualified professionals. Otherwise, it may cause personal injury or damage.
- Must follow the electric safety regulations when installing the unit.
- According to the local safety regulations, use qualified power supply circuit and circuit breaker.
- Do install the circuit breaker. If not, it may cause malfunction.
- An all-pole disconnection switch having a contact separation of at least 3 mm in all poles should be connected in fixed wiring.
- Include an circuit breaker with suitable capacity .Air switch should be included magnet buckle and heating buckle function, it can protect the short - circuit and overload.
- Air Conditioner should be properly grounded. Incorrect grounding may cause electric shock.
- Don't use unqualified power cord and cables.
- Make sure the power supply matches with the requirement of air conditioner. Unstable power supply or incorrect wiring can malfunction. Please install proper power supply cables before using the air conditioner.
- Properly connect the live wire, neutral wire and grounding wire of power socket. Be sure to cut off the power supply before proceeding any work related to electricity and safety.

Precautions



WARNING

To reduce the risk of explosion , fire, death, electric shock,injury or scalding to person when using this product , follow basic precautions, including the followings

2. Operation and Maintenance

- This appliance can be used by children aged from 8 years and above and persons with reduced physical, sensory or mental capabilities or lack of experience and knowledge if they have been given supervision or instruction concerning use of the appliance in a safe way and understand the hazards involved.
- Children shall not play with the appliance and accessories.
- Cleaning and user maintenance shall not be done by children.
- Do not connect air conditioner to multi-purpose socket. Otherwise, it may cause fire hazard.
- Do disconnect power supply when cleaning air conditioner. Otherwise, it may cause electric shock.
- If the supply cord is damaged, it must be replaced by the manufacturer, its service agent or similarly qualified persons in order to avoid a hazard.
- After removing the filter, do not touch fins to avoid injury.
- Do not use fire or hair dryer to dry the filter to avoid deformation or fire hazard.
- Maintenance must be performed by qualified professionals. Otherwise, it may cause personal injury or damage.



WARNING

3. Service and Repair

- Do not repair air conditioner by yourself. It may cause electric shock or damage.
- Do not extend fingers or objects into air inlet or air outlet. It may cause personal injury or damage.
- Do not block air outlet or air inlet. It may cause malfunction.
- Do not spill water on the remote controller, otherwise the remote controller may get damage.
- When below phenomenon occurs, please turn off air conditioner and disconnect power immediately .
- Power cord is overheating or damaged.
- There's abnormal sound during operation .
- Circuit breaker trips off frequently.
- Air conditioner gives off burning smell.
- Indoor unit is leaking.
- If the air conditioner operates under abnormal conditions, it may cause malfunction, electric shock or fire hazard.
- When turning ON or turning OFF the unit by emergency operation switch, please press this switch with an insulating object other than metal.
- Do not step on top panel of outdoor unit, or put heavy objects. It may cause damage or personal injury

Precautions



WARNING

- Do not put through the power before finishing installation or servicing.
- The temperature of refrigerant circuit will be high, please keep the interconnection cable away from the copper tube.
- The appliance shall be installed in accordance with national wiring regulations.
- The air conditioner is the first class electric appliance. It must be properly grounded with specialized grounding device by a professional. Please make sure it is always grounded effectively, otherwise it may cause electric shock and malfunction.
- The yellow-green or green wire in air conditioner is grounding wire, which can't be used for other purposes.
- The grounding resistance should comply with national electric safety regulations.
- The appliance must be positioned so that the plug is accessible.
- All wires of indoor unit and outdoor unit should be connected by a professional.
- If the length of power connection wire is insufficient, please contact the supplier for a new one. Avoid extending the wire by yourself.

- For the air conditioner with plug, the plug should be reachable after finishing installation.
- For the air conditioner without plug, a circuit breaker must be installed in the line .
- If you need to relocate the air conditioner to another place, only the qualified person can perform the work. Otherwise, it may cause personal injury or damage.
- Select a location which is out of reach for children and far away from pets or plants. If it is unavoidable, please add the fence for safety purpose.
- The indoor unit should be installed close to the wall.



Cautions for using R32 refrigerant

1. Installation

- The installation of pipe-work shall be kept to a minimum.
- Pipe-work shall be protected from physical damage.
- Compliance with national gas regulations shall be observed.
- Mechanical connections shall be accessible for maintenance purposes.
- In case installation require mechanical ventilation, openings shall be kept clear off obstruction.
- When disposing off the product, it should be based on the national regulation and should be properly .

Precautions

2. Servicing:

1. Any person who is involved with working on or breaking into a refrigerant circuit should hold a current valid certificate from an industry-accredited assessment authority, which authorises their competence to handle refrigerants safely in accordance with an industry recognised assessment specification.
2. Servicing shall only be performed as recommended by the equipment manufacturer.
3. Maintenance and repair requiring the assistance of other skilled personnel shall be carried out under the supervision of the person competent in the use of flammable refrigerants.
4. Do not use means to accelerate the defrosting process or to clean, other than those recommended by the manufacturer.
5. The appliance shall be stored in a room without continuously operating ignition sources (for example: open flames, an operating gas appliance or an operating electric heater)
6. Do not pierce or burn.
7. Be aware that refrigerants may not contain an odour.
8. Be more careful that foreign matter (oil, air, water, etc) does not enter the piping. Also, when storing the piping, securely seal the opening by pinching, taping, etc.

For indoor units, use R32 flareless joint assy only when connecting the indoor unit and connecting piping (when connecting indoors). Use of pipes, flareless nut or flare nuts other than specified, may cause product malfunction, burst piping, or injury due to high internal pressure of the refrigerant cycle caused by any inflow air.



WARNING

Appliance shall be stored in a well-ventilated area where the room size corresponds to the room area as specific for operation. For R32 refrigerant models: Appliance shall be installed, operated and stored in a room with a floor area larger than 4 m².

Precautions







WARNING:

Installation, servicing and decommissioning shall only be performed as manufacturer. Maintenance and repair requiring the assistance of other skilled personnel shall be carried out under the supervision of the person competent in the use of flammable refrigerants. For more details ,please refer to the

section of " Information on servicing" . (This is only required for R32 refrigerant only) for the unit adopts R32 Refrigerant).

Explanation of symbols displayed on the indoor unit or outdoor unit (For the unit adopts R32 Refrigerant only):

	WARNING	This symbol shows that this appliance used a flammable refrigerant. If the refrigerant is leaked and exposed to an external ignition source, there is a risk of fire.
	CAUTION	This symbol shows that the operation manual should be read carefully.
	CAUTION	This symbol shows that a service personnel should be handling this equipment with reference to the installation manual.
	CAUTION	This symbol shows that the process requires reference from manual.
	CAUTION	This symbol shows that information is available such as the operating manual or installation manual.

INDOOR UNIT INFORMATION

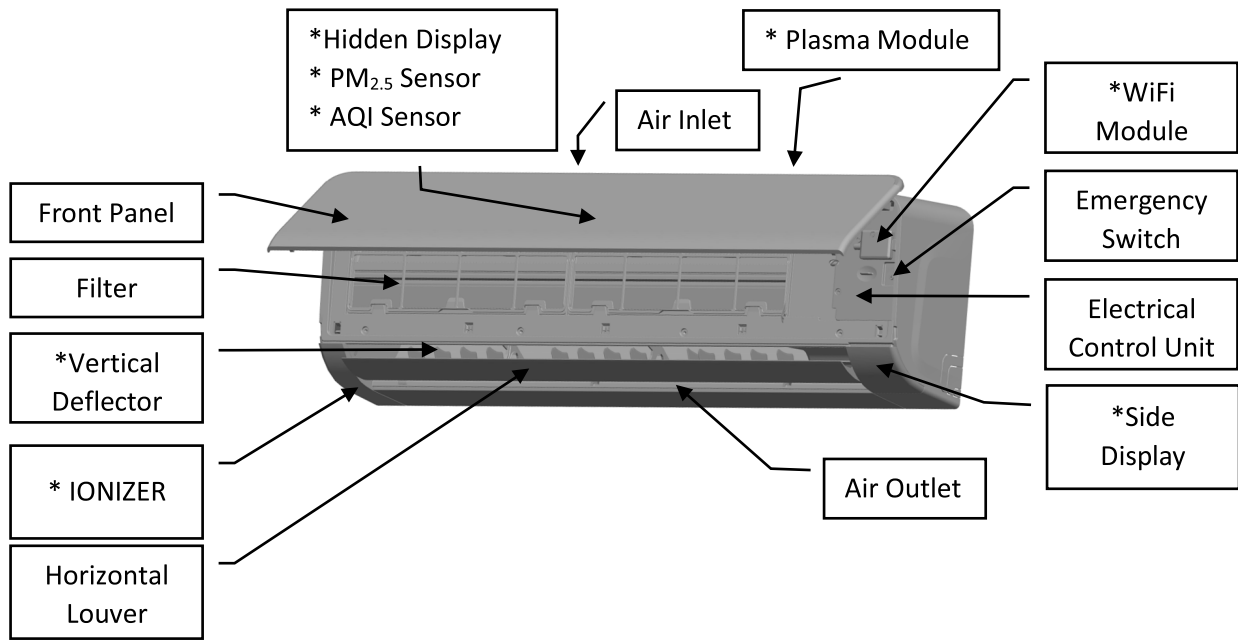

HIDDEN DISPLAY INDICATION INFORMATION

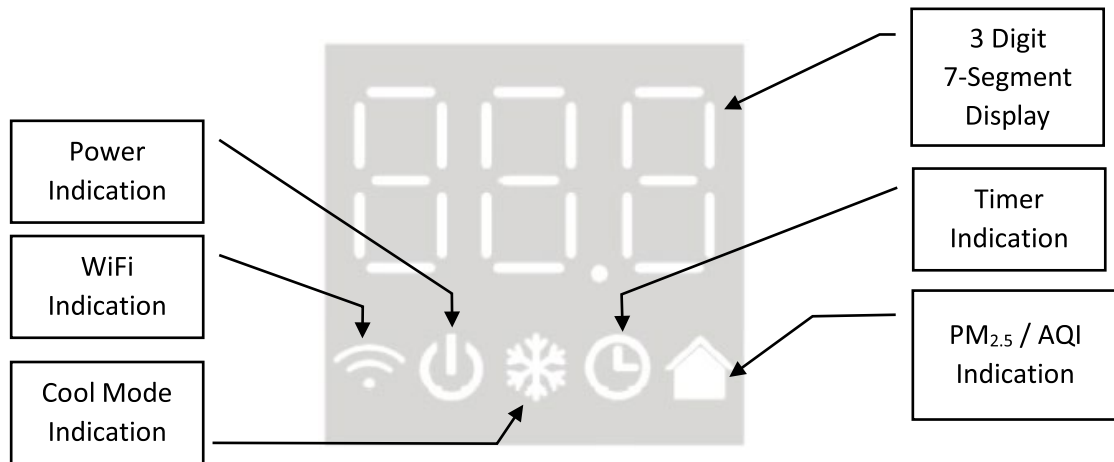
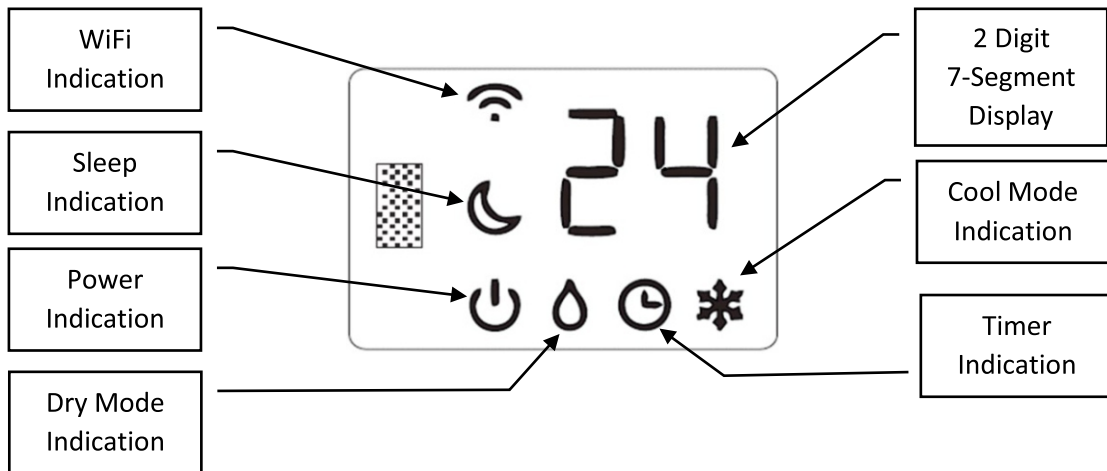

Display content or the position may be different from the above graphics, please refer to actual product. Asterisk * marked function are optional and available in selected models only.

SIDE DISPLAY AND INDICATION INFORMATION

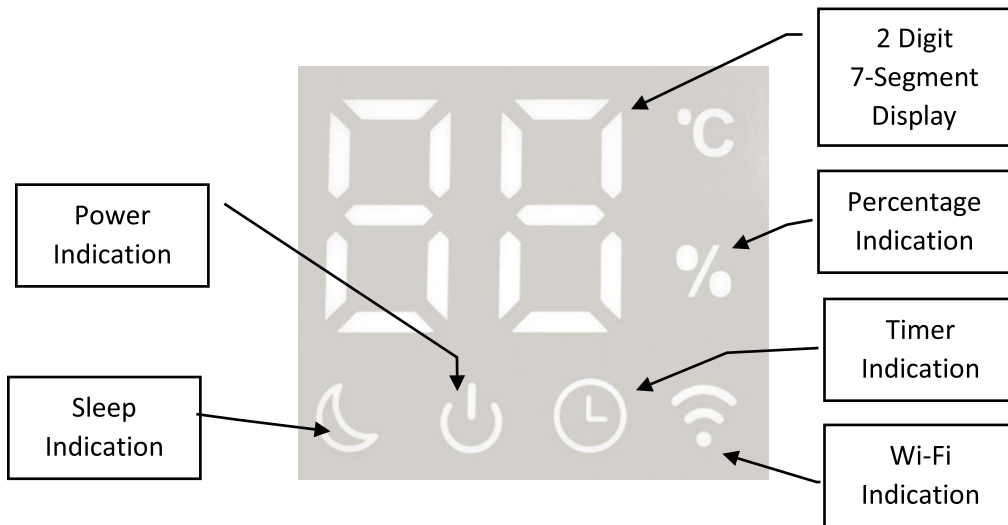
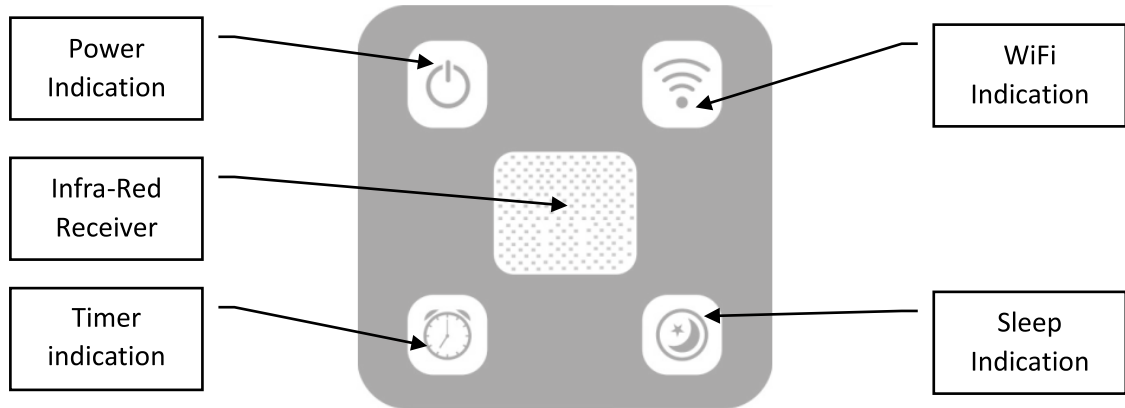

Use the remote control within 8 meters of the indoor unit, and the remote control receiver should be in line of sight.

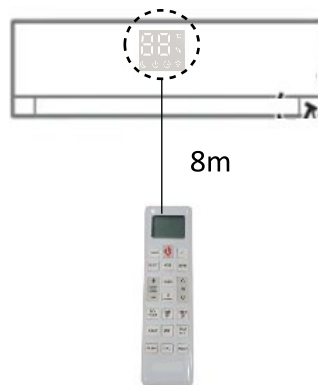

*Display content or the position may be different from the above graphics, please refer to actual product. Asterisk * marked function are optional and available in selected models only.*

REMOTE HANDSET & BUTTON INFORMATION

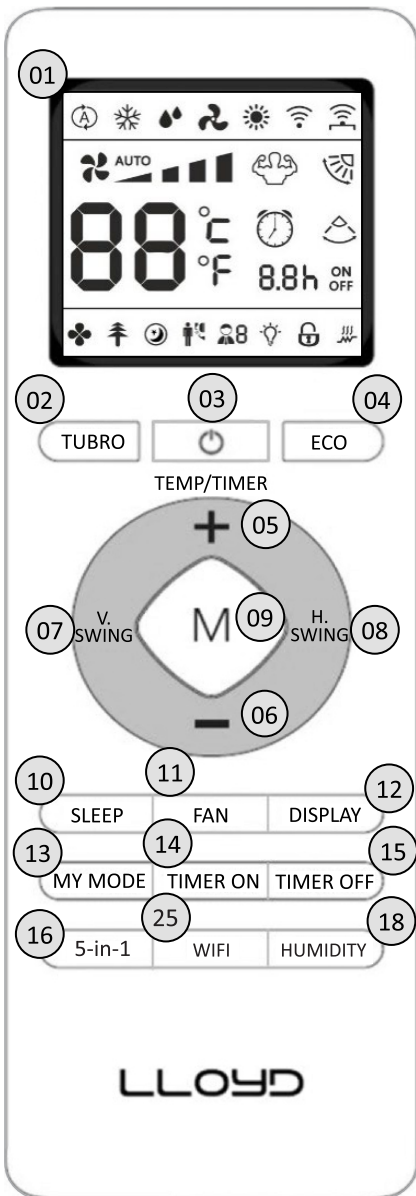

TYPE - A

1. LCD DISPLAY
2. TURBO BUTTON
3. POWER BUTTON
4. ECO BUTTON
5. PLUS BUTTON
6. MINUS BUTTON
7. V-SWING BUTTON
8. H-SWING BUTTON
9. MODE BUTTON
10. SLEEP BUTTON
11. FAN BUTTON
12. DISPLAY BUTTON
13. MY MODE BUTTON
14. TIMER ON BUTTON
15. TIMER OFF BUTTON
16. 5-in-1 BUTTON
17. IAQ BUTTON
18. PUROAIR/ HUMIDITY BUTTON
19. 6-in-1 BUTTON
20. CONSTANT BUTTON
21. MIC BUTTON
22. SILENT BUTTON
23. PM_{2.5} / LOCK BUTTON
24. RESET BUTTON
25. WIFI BUTTON

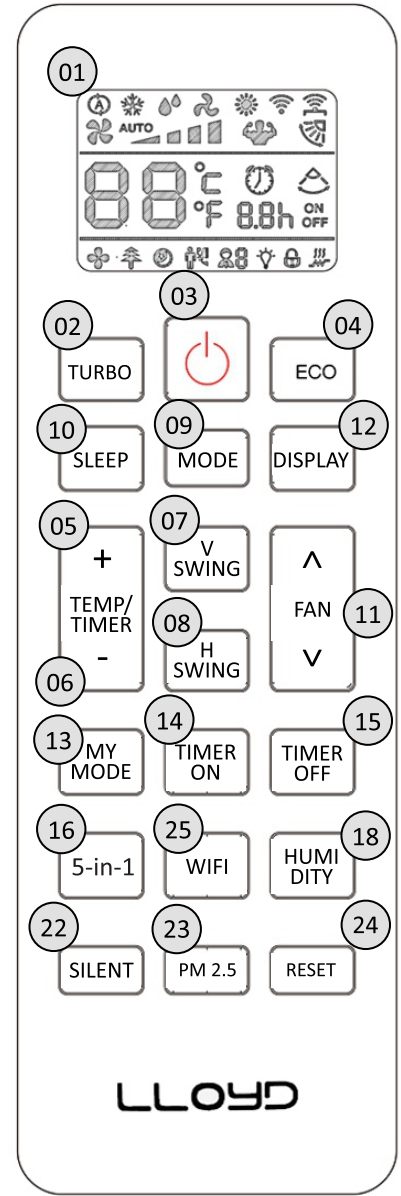

TYPE - B



Display content or the position may be different from the above graphics, please refer to actual product. Asterisk * marked function are optional and available in selected models only.

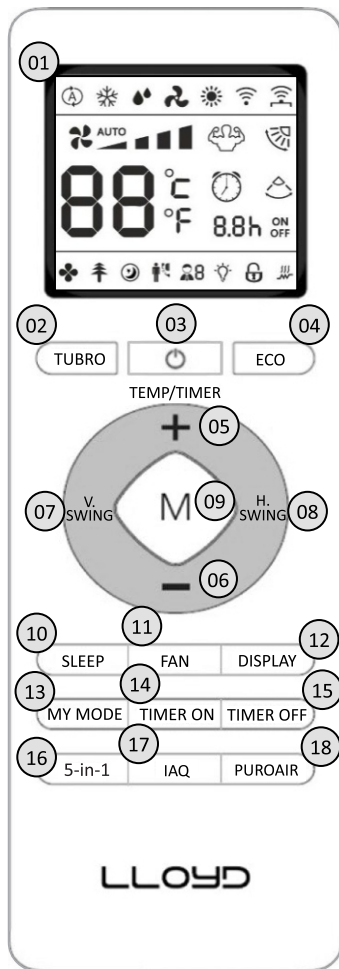

TYPE - C

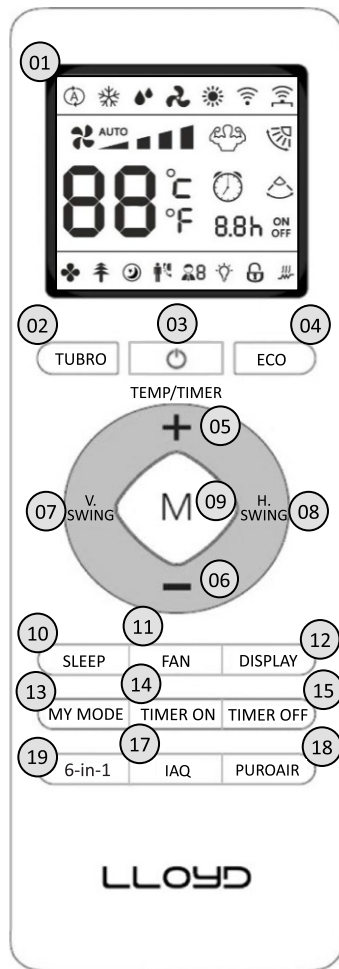

TYPE - D

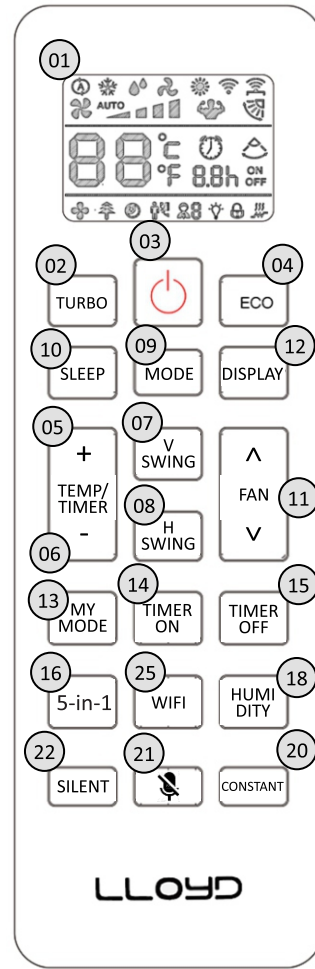

TYPE - E

REMOTE HANDSET LCD INFORMATION

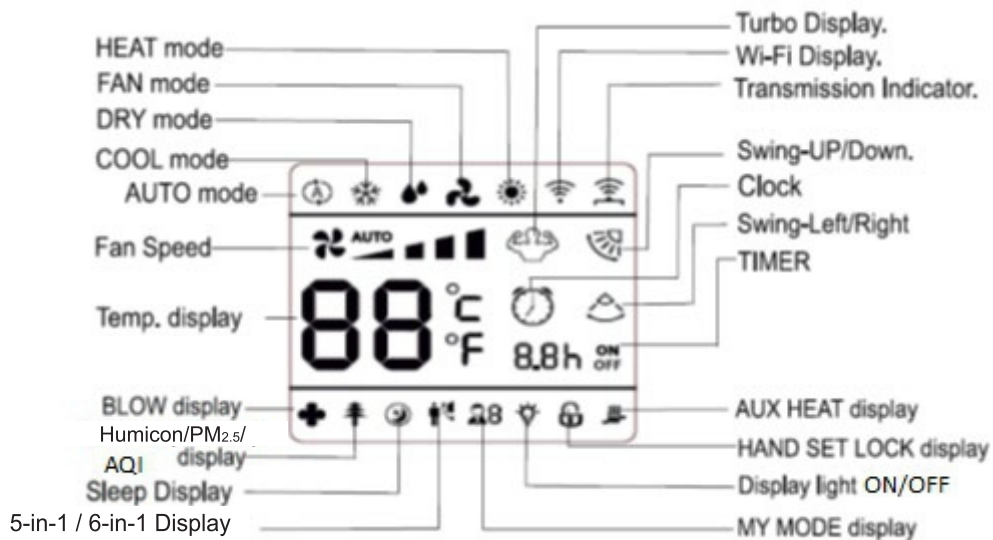

Display content or the position may be different from the above graphics, please refer to actual product. Asterisk * marked function are optional and available in selected models only.

OPERATION GUIDE

SALIENT FEATURES

- ❖ DUAL DIGIT DIGITAL HIDDEN DISPLAY & LED INDICATOR DISPLAY OPTIONS
- ❖ WIRELESS REMOTE HANDSET
- ❖ MULTIPLE OPERATING MODES [AUTO, COOL, DRY, FAN, *HEAT]
- ❖ DIGITAL CONTROL OF SET TEMPERATURE RANGE 16 °C TO 30 °C
- ❖ MULTIPLE FAN SPEED (AUTO, SILENT, LOW, MEDIUM AND HIGH)
- ❖ ON & OFF TIMERS (24 HOURS).
- ❖ *INTELLIGENT DIAGNOSIS
- ❖ *REFRIGERANT LEAK DETECTION
- ❖ *5-in-1 , *6-in-1
- ❖ *HUMIDITY
- ❖ *FILTER CLEANING INDICATION
- ❖ TURBO, SILENT, SLEEP, *WIFI, *SMART ECO & LOCK FUNCTIONS, *CONSTANT, * ODV
- ❖ *AQI & *PM_{2.5} DISPLAY & COLOUR INDICATION

OPERATION OF WIRELESS REMOTE HANDSET

The wireless remote handset is a versatile and user-friendly device that allows users to control the air conditioning system's cooling, *heating, and other functions. It's simple to understand and easy to use thanks to the LCD display with *LCD backlighting and night glow buttons.

FACTORY RESET

Remote handset can be reset to factory setting by putting batteries back again after removing the battery from the handset for some time. Remote handset with *RESET button can be done by pressing RESET button continuously for more than 10 s

After reset all icons on remote handset LCD will turn ON for 3 s.

DEFAULT SETTINGS

By default, remote handset will be set to COOL mode, 24 °C set temperature, Display/Light function ON, Auto Fan Speed in Standby/OFF state. *Backlight will also turn ON for some time.

 *Note: In COOL, DRY and AUTO mode (Cooling modes), if the unit is turned OFF and turned ON using remote handset, default 24 °C will be automatically selected and corresponding function will be transmitted from the remote handset after turning ON.*

**In COOL mode if previous set temperature is between 16 °C to 23 °C, after turning OFF using remote handset, set temperature will be set to default 24 °C when unit is turned on using remote handset.*

**If previously set temperature is equal to above 24 °C, after turning OFF using remote handset, set temperature will remain unchanged when unit is turned on using remote handset (except in DRY mode).*

This will be applicable to all the product manufactured after Jan-2020 as per regulation.



*Display content or the position may be different from the above graphics, please refer to actual product. Asterisk * marked function are optional and available in selected models only.*

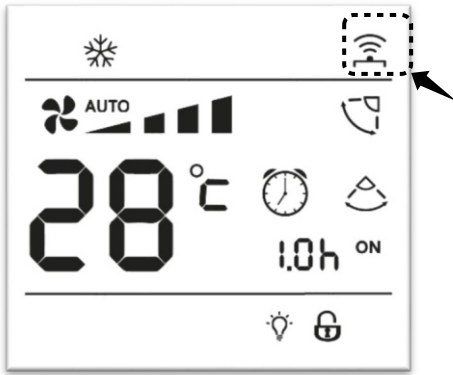

IR TRANSMISSION INDICATOR

Whenever signal is sent through remote handset  icon will be displayed on remote handset.

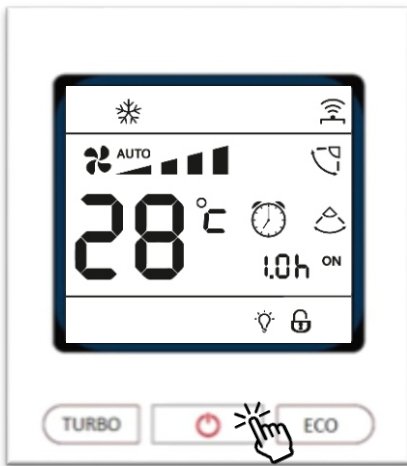

POWER ON/OFF BUTTON

Press POWER  button to turn the air conditioner ON or OFF.



POWER ON STATE

During Power ON state, the two partition lines will illuminate on remote handset display. In this state you can use all function and features for remote handset.



POWER OFF/STANDBY STATE

During Power OFF/Standby state, the two partition lines will disappear from the remote handset display. In this state you can set ON/OFF Timer, LIGHT/DISPLAY, and WI-FI.



*Display content or the position may be different from the above graphics, please refer to actual product. Asterisk * marked function are optional and available in selected models only.*

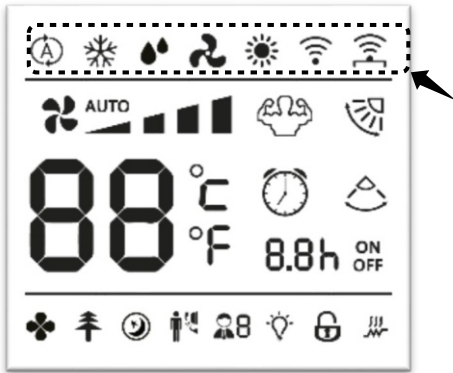

MODE

Use MODE  button to select one of the available modes. The selected mode will be displayed on the remote handset and the appropriate indication will illuminate on remote handset display.

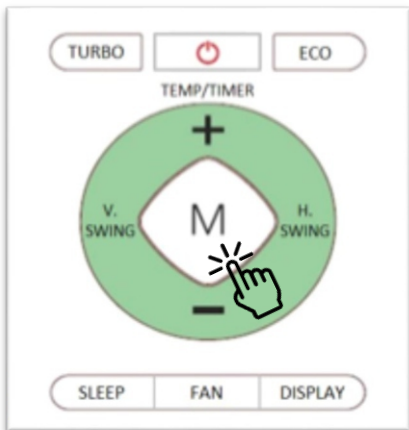

Each time when you press the Mode button, operating mode will change in cyclic order from COOL, DRY, FAN, *HEAT & AUTO.

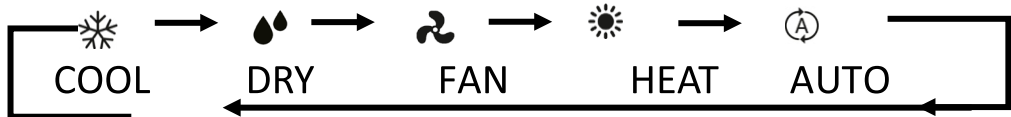

AUTO

Use Auto mode to perform the comfortable cooling and heating automatically. When the difference between the room temperature and the set temperature decreases, the air conditioner controls the fan speed and compressor speed automatically.



*Display content or the position may be different from the above graphics, please refer to actual product. Asterisk * marked function are optional and available in selected models only.*



COOL

In Cool mode, the air conditioner will cool your room as per your preference selected using remote handset. You can adjust the set temperature, fan speed, swing angles, etc. System varies compressor speed to maintain the desired temperature. Setting temperature range is 16 °C to 30 °C from the wireless remote handset. By default, set temperature is 24 °C after replacing the batteries.

- If the outdoor temperature is much higher than the indoor set temperature, it may take time to bring the indoor temperature to the desired level.



*DRY

In this mode air conditioner acts like a dehumidifier and remove moisture from indoor air. Dry mode makes the air feel refreshing in a humid climate.

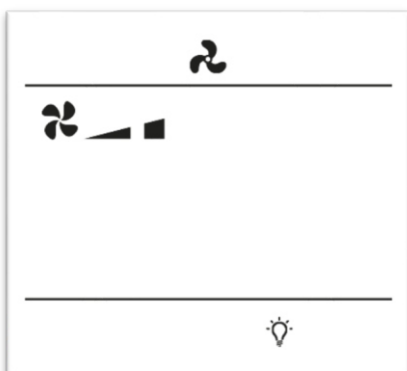
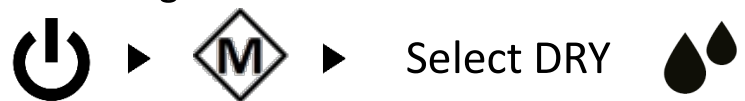

FAN

Fan mode can be selected to circulate air in your room. Fan mode will be helpful to refresh the stale air in your room.



*Display content or the position may be different from the above graphics, please refer to actual product. Asterisk * marked function are optional and available in selected models only.*



*HEAT

In Heat-Cool air conditioner you can warm your room using heat mode.

- Fan may not operate, and Flap will set to default for some time in the beginning to prevent cold breeze.
- Since the air conditioner heats the room by taking heat energy from outdoor air, the heating capacity may decrease when outdoor temperature is extremely low.
- Use an additional heating appliance in combination with the air conditioner if you feel the air conditioner heats insufficiently.



Note: Heat mode is an optional feature and work in selected models only.

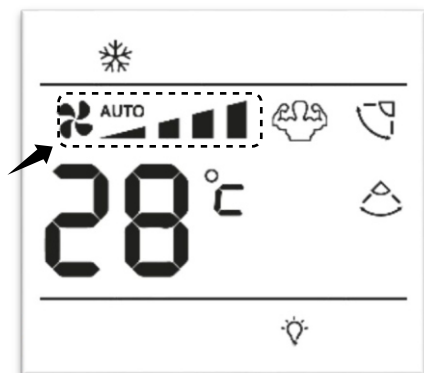

FAN

Press the fan button to select desire fan speed. The selected fan speed will be displayed on the remote handset and the appropriate indication will illuminate on remote handset display.



*Display content or the position may be different from the above graphics, please refer to actual product. Asterisk * marked function are optional and available in selected models only.*

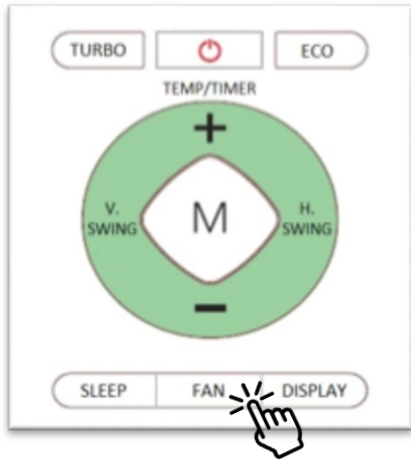

Each time you press the FAN button, FAN SPEED will change as per below cyclic order. Use UP/DOWN button in FAN to increase or decrease fan speed. Silent function can be selected directly in the remote with dedicated SILENT button.



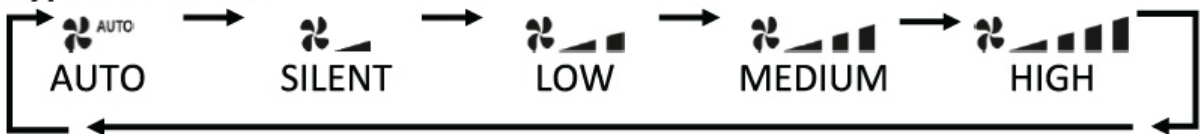

















Type A remote :



Type B remote :



Fan button selection in different modes and function.

AUTO/HUMIDITY /ECO	
DRY	
FAN	  
C1 (5-in-1)	  
C2 (5-in-1)	   
C3 (5-in-1)	    
COOL/HEAT/CA C4/SLEEP MY MODE SETTING	   
TURBO	Selection of fan speed is possible and TURBO function will exit.



Display content or the position may be different from the above graphics, please refer to actual product. Asterisk * marked function are optional and available in selected models only.

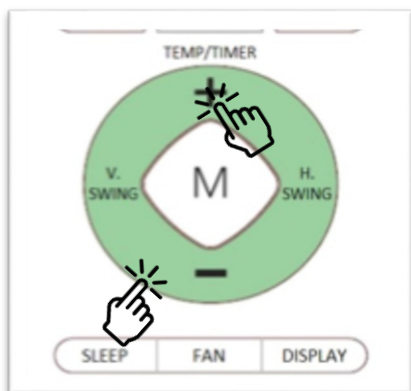

+ (PLUS) /- (MINUS)

Press + (PLUS) /- (MINUS) button to increase or decrease set temperature in different modes. Using this button, you can also increase or decrease timer in TIMER ON & TIMER OFF function.

+ (PLUS) /- (MINUS) button in different modes and function.

HUMIDITY	Adjust the desired temperature by 1 °C within the range of 22 °C ~ 26 °C.
ECO/AUTO/FAN	Temperature adjustment is not possible.
COOL / DRY / HEAT / 5-in-1 /6-in-1/ SLEEP/ MY MODE SETTING/CONSTANT	Adjust the desired temperature by 1 °C within the range of 16 °C ~ 30 °C.
TIMER ON/OFF	You can adjust the desired time by 30 min between 0 h to 10 h and by 1.0 h between 10 h to 24 h

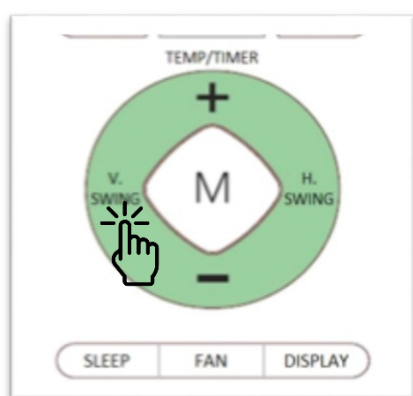

VERTICAL SWING

Press V SWING button on the remote controller to select desired air flow direction.

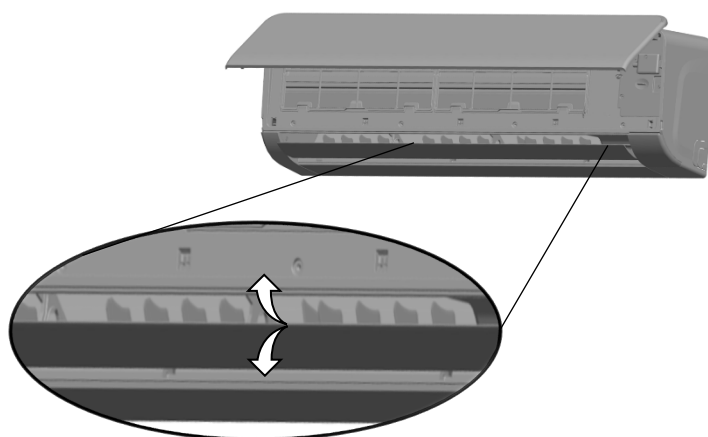

*Display content or the position may be different from the above graphics, please refer to actual product. Asterisk * marked function are optional and available in selected models only.*



Each time when you press the V SWING button, air flow blade will change as per below cyclic order. The selected swing position will be displayed on the remote handset and the appropriate indication will illuminate on remote handset display.

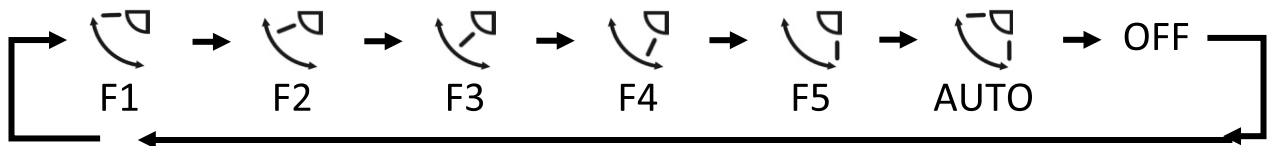

 *Note: If you adjust the vertical air flow blade manually, it may not close completely when you turn off the air conditioner.*

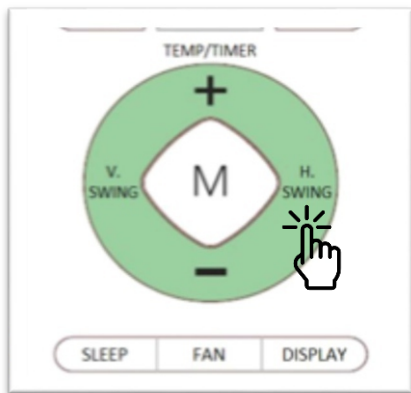

*HORIZONTAL SWING

Press H SWING button on the remote controller to select desire air flow direction.

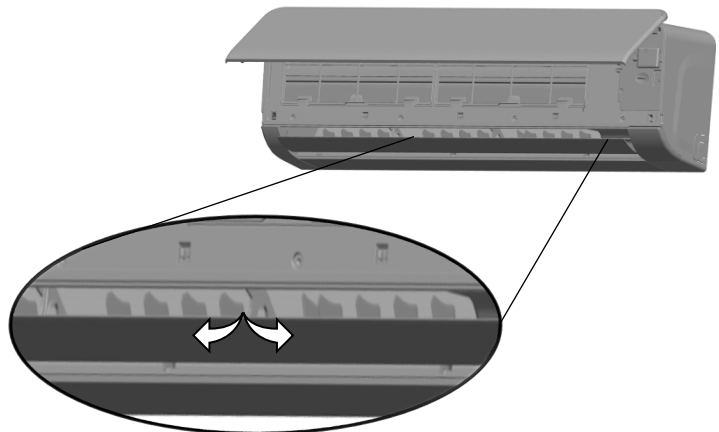

*Display content or the position may be different from the above graphics, please refer to actual product. Asterisk * marked function are optional and available in selected models only.*

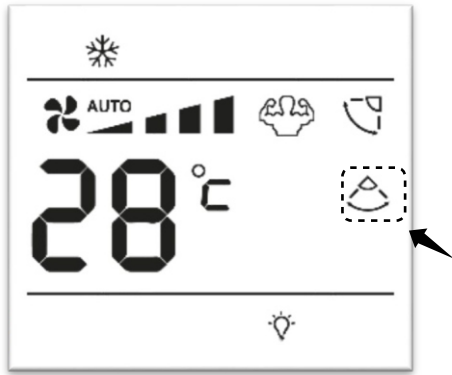

Press H SWING button in the remote handset to enable Auto Swing and icon will appear on remote handset display, press the button again to disable this function and icon will disappear from remote handset display.

V SWING & H SWING selection in different modes and function.

AUTO/COOL/DRY/ FAN/HEAT	You can adjust the desired SWING.
HUMIDITY/ECO/ SLEEP/5-in-1/ 6-in-1/CONSTANT/ MY MODE SETTING	You can adjust the desired SWING.

 *Note: If you adjust the vertical air flow blade manually, it may not close completely when you turn off the air conditioner. Horizontal swing is an optional feature available in selected models only.*

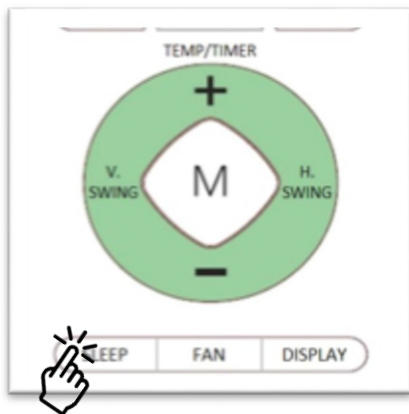



SLEEP

You can set the SMART SLEEP function by pressing SLEEP button from the remote handset and ☺ icon will appear on remote handset display, press the button again to disable this function and the ☺ icon will disappear.

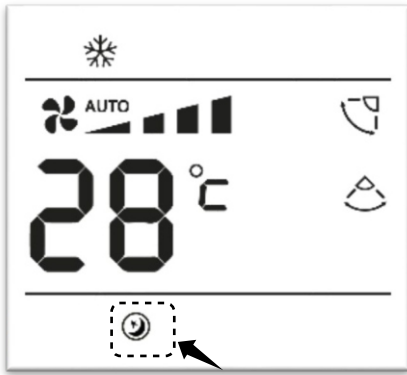

*Display content or the position may be different from the above graphics, please refer to actual product. Asterisk * marked function are optional and available in selected models only.*



When Sleep function is selected, on indoor display  icon will glow and display light will get dim. After eight consecutive hours Sleep function will automatically exit and in fixed speed model/in INV model, unit will run continuously.

 **Note:**

INV: - In sleep mode, the user set temperature will increase automatically in the background.



Fix Speed:- On the 7-segment display, the user set temperature will rise automatically

SLEEP selection in different modes and function.

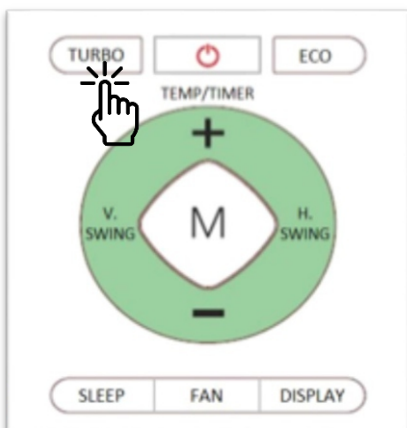
AUTO/DRY/FAN	Selection of SLEEP function is not possible.
COOL/5-in-1/ 6-in1/ CONSTANT /Heat	Selection of SLEEP function is possible.
ECO	Selection of SLEEP function is possible and ECO function will exit.
HUMIDITY/MY MODE SETTING	Selection of SLEEP function is not possible.



TURBO

You can set the TURBO function to use powerful cooling/heating. Press TURBO button from the remote handset to enable this function and  icon will appear on remote handset display, press the button again to disable this function and the  icon will disappear.



*Display content or the position may be different from the above graphics, please refer to actual product. Asterisk * marked function are optional and available in selected models only.*

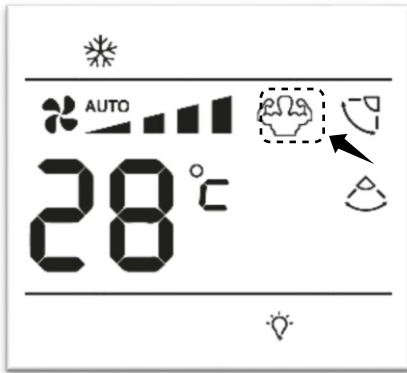

TURBO selection in different modes and function.

HUMIDITY/AUTO/DRY /FAN/C1, C2, C3, (5-in-1) MY MODE SETTING	Selection of TURBO function is not possible.
COOL/HEAT/CA, C4 (5-in1), C4&C5 (6-in-1)/CONSTANT	Selection of TURBO function is possible. If the set temperature is 16 °C, TURBO function will continue to run. If the set temperature is 17 °C to 30 °C TURBO function will automatically exit after 60 min
ECO/SLEEP	Selection of Sleep and ECO is possible and TURBO function will exit.

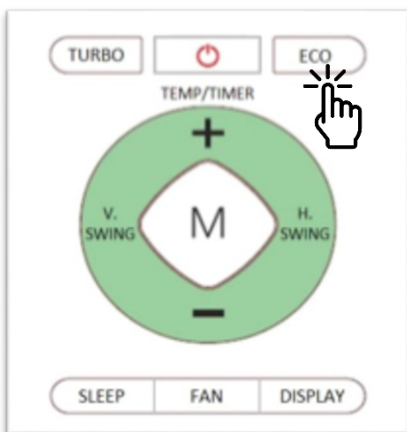

*SMART ECO

You can set the SMART ECO function by pressing ECO button from the remote handset, press the button again to disable this function.



*Display content or the position may be different from the above graphics, please refer to actual product. Asterisk * marked function are optional and available in selected models only.*

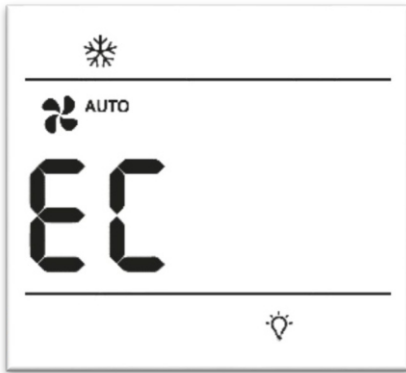



ECO Will be displayed at set temperature location when this function is selected.

SMART ECO selection in different modes and function.

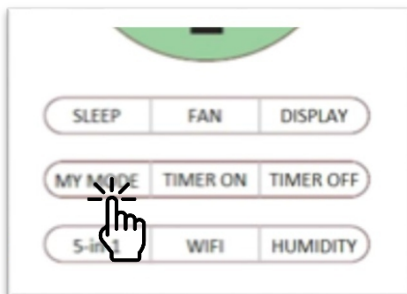
AUTO/DRY/FAN/ CONSTANT	Selection of ECO function is not possible.
COOL/HEAT/ CA	Selection of ECO function is possible, and Air Conditioner will set to 24 °C with fan speed will set to AUTO.
HUMIDITY/C1, C2, C3 & C4 (5-in-1)/ 6-in-1& MY MODE SETTING	Selection of ECO function is not possible.



MY MODE

You can set MY MODE function by pressing the MY MODE button continuously for 2 s from the remote handset and  icon will appear on remote handset display, press the button again continuously for 2 s to disable this function and  icon will appear on remote handset display. You can set Timer ON/OFF in my mode function.



*Display content or the position may be different from the above graphics, please refer to actual product. Asterisk * marked function are optional and available in selected models only.*

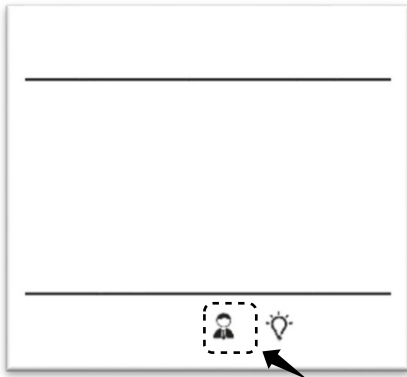

In my mode setting you can save your preferred setting like, MODE, FAN SPEED, SET TEMPERATURE, H-SWING, V-SWING in remote handset memory.

To setup my mode setting, in normal mode press the MY MODE button continuously for long time. Remote handset will go into MY MODE setting menu and  icon will start blinking. By default in MY MODE, mode will set to AUTO, fan speed will set to AUTO, set temperature will set to 24 °C. To exit MY MODE from setting menu, press the MY MODE button again continuously for 2 seconds.

MY MODE selection in different modes and function.

<p>AUTO/DRY/FAN COOL/HEAT/CA/</p>	<p>Selection of MY MODE function is possible. Air conditioner will exit from previous mode and start running as per MY MODE.</p>
<p>5-in-1/6-in-1/ SLEEP HUMIDITY/ECO/ TURBO</p>	<p>Selection of MY MODE function is not possible.</p>

 *Note: After battery replacement, need to setup MY MODE setting again*



TIMER

In this remote handset you can set TIMER ON/ TIMER OFF separately as well as together at any state of remote. Timer can be set form

30 min to 24 h. From 30 min to 10 h you can select timer in 30 min time. From 10 h to 24 h you can set timer in 60 min time.



*Display content or the position may be different from the above graphics, please refer to actual product. Asterisk * marked function are optional and available in selected models only.*

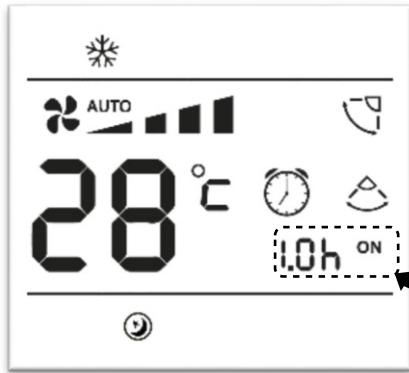

TIMER ON

You can set the TIMER ON function by pressing TIMER ON. ⌚ icon and **ON** icon will start blinking on remote handset 8.8h will set to

0.0 h. Press + (PLUS) / -(MINUS) button to select desire hour. Press TIMER ON button again to save the timer.



TIMER OFF

You can set the TIMER OFF function by pressing TIMER OFF. ⌚ icon and **OFF** icon will start blinking on remote handset 8.8h will set to

0.0 h. Press + (PLUS) / -(MINUS) button to select desire hour. Press TIMER OFF button again to save the timer.

TIMER ON/OFF selection in different modes and function.

AUTO/ COOL /DRY/FAN/ HEAT/ HUMIDITY/5-in-1/ 6-in-1/TURBO/SLEEP/ECO/ CONSTANT	Selection of TIMER ON/OFF function is possible.
MY MODE SETTING	Selection of TIMER ON/OFF function is not possible.



If the timer to 0.0 h and saved the respective timer will get disable.

TIMER ON & OFF COMBINATION

When the air conditioner is in ON state	When the air conditioner is in OFF/STANDBY state
Preset time in TIMER ON is longer than TIMER OFF	Preset time in TIMER ON is longer than TIMER OFF



*Display content or the position may be different from the above graphics, please refer to actual product. Asterisk * marked function are optional and available in selected models only.*

E.g. TIMER ON set to 5 h & TIMER OFF is set to 1 h, the air conditioner will operate TIMER OFF and unit will turn OFF after 1 hour from the moment you have set the timer. Your air conditioner will turn ON after 4 hours after unit turned OFF.

E.g. TIMER ON set to 5 h & TIMER OFF is set to 1 h, the air conditioner will operate TIMER OFF and unit will remain OFF. Your air conditioner will turn ON after 5 hours from the moment you have set the timer.



Preset time in TIMER ON is shorter than TIMER OFF
E.g. TIMER ON set to 10 h & TIMER OFF is set to 13 h, the air conditioner will operate TIMER ON first and unit will remain ON. Your air conditioner will turn OFF after 13 hours from the moment you have set the timer.

Preset time in TIMER ON is shorter than TIMER OFF
E.g. TIMER ON set to 10 h & TIMER OFF is set to 13 h, the air conditioner will operate TIMER ON first and unit will turn ON after 10 hours from the moment you have set the timer. Your air conditioner will turn OFF after 3 hours after unit turned ON.

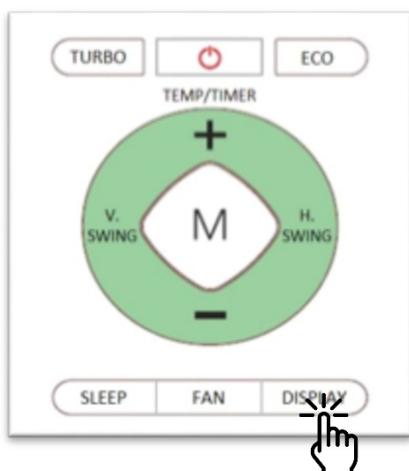
 *Timer ON and OFF setting time should be different from each other. First timer as per time will be available on remote handset display. After the completion of timer, the respective timer will disappear from remote handset. If battery remove, TIMER setting will erase from remote handset only.*



DISPLAY/LIGHT

You can turn ON or OFF indoor display panel using this function. Default factory setting, this function is always ON and  icon will illuminate on remote handset. By pressing DISPLAY button, you can turn OFF indoor display and  icon will disappear on remote handset display.



*Display content or the position may be different from the above graphics, please refer to actual product. Asterisk * marked function are optional and available in selected models only.*

Press DISPLAY button again to turn on this function.

When the DISPLAY is OFF

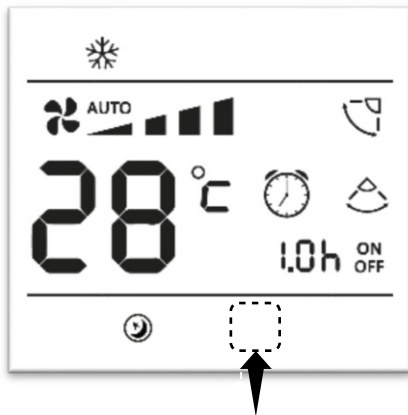

When the DISPLAY is ON

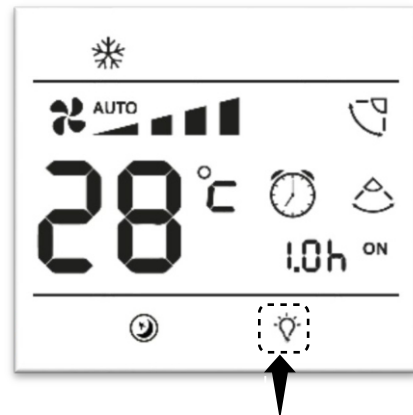

DISPLAY/LIGHT selection in different modes and function.

AUTO/ COOL /DRY/FAN/ HEAT/HUMIDITY/ 5-in-1/6-in-1/TURBO/SLEEP/ECO/CONSTANT	Selection of DISPLAY function is possible.
REMOTE OFF/STANDBY STATE	Selection of DISPLAY function is possible.
MY MODE SETTING	Selection of DISPLAY function is not possible.

Buzzer:-

- When Power ON, buzzer will beep for two times.
- When Power OFF, Buzzer will beep long for one time
- Same repeated command selected again, then buzzer will beep for three times.



***5-in-1**



You can select different capacity levels using this function. This function can work only in AUTO and COOL mode. Default factory setting air conditioner will run in CA. Selected Capacity level will change as per below cyclic order.

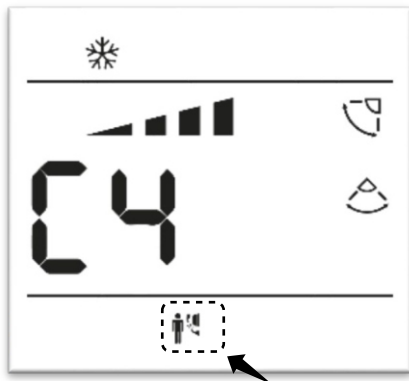
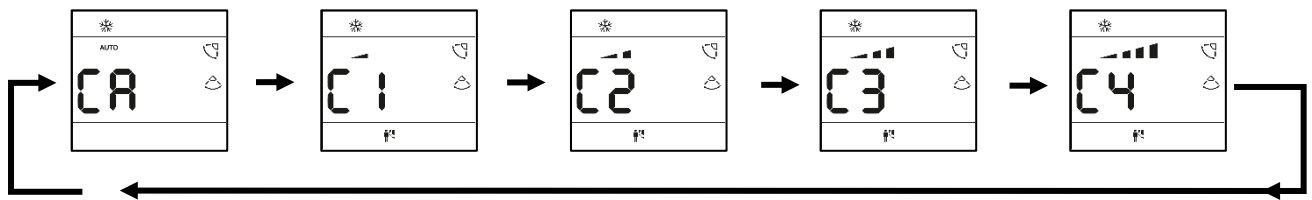

*Display content or the position may be different from the above graphics, please refer to actual product. Asterisk * marked function are optional and available in selected models only.*











Press 5-in-1 button for the first time, preset selected level will show on remote handset display. Press the button again within 3 seconds to change the capacity as C1, C2, C3, C4 and the respective capacity level will be displayed on the remote handset as well as on indoor display.

When capacity C1 to C4 is selected,  icon will appear and when CA is selected  icon will disappear from the remote handset.

 *Note: In C1, C2, C3 the air conditioner will run in less capacity than rated capacity.*

- Fan Speed for 5-in -1 feature

C1 (5-in-1)				
C2 (5-in-1)				
C3 (5-in-1)				
CA/C4				

5-in-1 selection in different modes and function.

AUTO/COOL/HEAT	Selection of 5-in-1 function is possible.
DRY/FAN/ MY mode	Selection of 5-in-1 function is not possible.
C4	Selection of TURBO function is possible.
C1/C2/C3/C4	Selection of SLEEP function is possible
C1/C2/C3/C4	Selection of ECO is not possible



*Display content or the position may be different from the above graphics, please refer to actual product. Asterisk * marked function are optional and available in selected models only.*

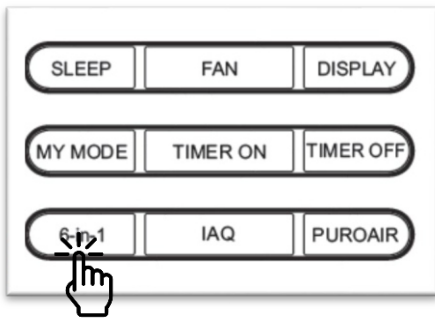

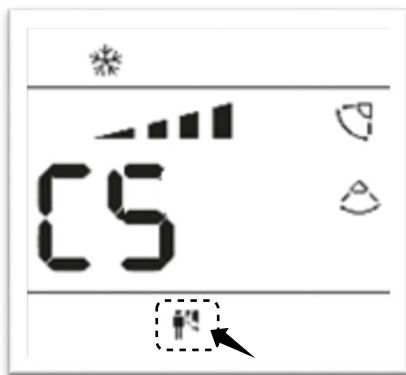
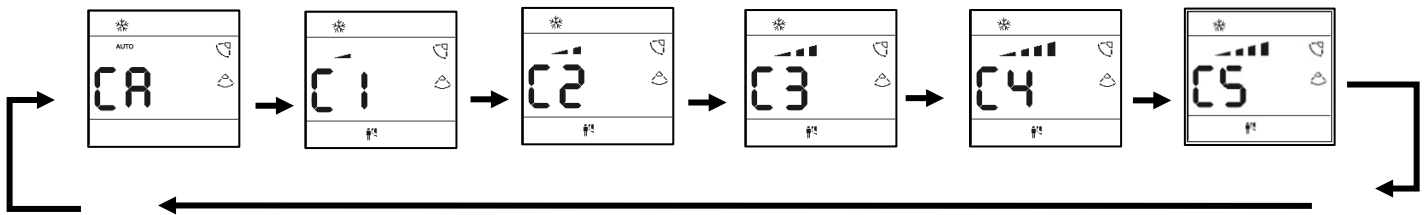

*6-in-1

You can select different capacity levels using this function. This function can work only in AUTO and COOL mode. Default factory setting air conditioner will run in CA. Selected Capacity level will change as per below cyclic order.



Press 6-in-1 button for the first time, preset selected level will show on remote handset display. Press the button again within 3 seconds to change the capacity as C1, C2, C3, C4, C5 and the respective capacity level will be displayed on the remote handset as well as on indoor display.

When capacity C1 to C5 is selected,  icon will appear and when CA is selected  icon will disappear from the remote handset. When capacity C5 is selected then 4 bars  on remote screen will blink till the screen shift to set temp screen



Note: In C1, C2, C3 the air conditioner will run in less capacity than rated capacity.



*Display content or the position may be different from the above graphics, please refer to actual product. Asterisk * marked function are optional and available in selected models only.*

- Fan Speed for 6-in -1 feature

C1	AUTO	
C2	AUTO	
C3	AUTO	
CA/C4/C5	AUTO	

- 6-in-1 selection in different modes and function.

AUTO/COOL/HEAT	Selection of 6-in-1 function is possible.
C4,C5	Selection of TURBO function is possible.
C1, C2, C3, C4, C5	Selection of Sleep function is possible.
C1,C2, C3, C4, C5	Selection of ECO function not possible

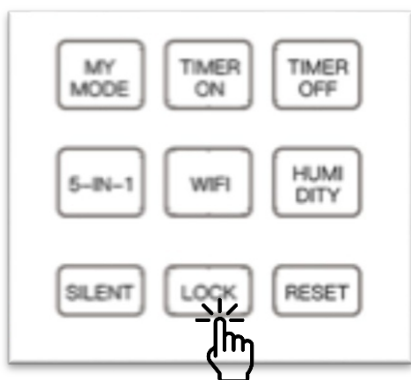

LOCK

This is a child lock feature. Press and hold *LOCK button continuously for some time to lock the remote handset at the current set. Press and hold – (MINUS) button and FAN button together continuously for some time to lock the remote handset where LOCK button is not available. icon will appear on remote handset display when the remote is lock. You will not able to change any function until it is unlocked. During remote lock condition, if you press any button, icon will blink for some time to



*Display content or the position may be different from the above graphics, please refer to actual product. Asterisk * marked function are optional and available in selected models only.*

indicate that the lock function is currently activate. To unlock press and hold the button again continuously for some. After unlocking  icon will disappear form remote display.

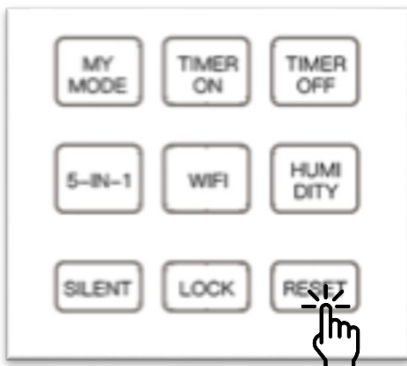

RESET

Using this function, you can reset your remote handset to default factory setting. Press and hold *RESET button or MINUS & FAN button (remote handset without RESET button) together for some time, remote handset will reset and restart again in default position. You can also reset the remote handset by removing the batteries from remote handset and pressing any key without inserting back the batteries. After reinstalling the batteries, remote will restart in default factory mode.



Note: After reset or removal of batteries, remote handset memory will also get reset and all the saved functions like MY MODE, TIMER, PRESET setting will erase from the remote handset memory.



*CONSTANT

Use CONSTANT mode to get constant cooling.

To enable or disable CONSTANT function press CONSTANT button from



*Display content or the position may be different from the above graphics, please refer to actual product. Asterisk * marked function are optional and available in selected models only.*



the remote. CONSTANT Mode can be selected in COOL, DRY and HEAT mode only.

To get constant cooling press “CONSTANT” button to turn the unit in CONSTANT mode.



- “Cn ON” will appear on remote handset display.
- “Cn” will appear on indoor unit display.



Press the button again to exit CONSTANT mode.

- “Cn OFF” will appear on remote handset display.
- Unit will return to normal operation mode

 *Note: Constant function will work efficiently in standard voltage and temperature condition. This function is available in selected models only.*

CONSTANT selection in different modes and function.

MY MODE / 5-IN-1/ 6-in-1/AUTO/FAN/HUMIDITY/ ECO	Selection of CONSTANT function is not possible.
COOL/DRY/HEAT	Selection of CONSTANT function is possible.
CONSTANT	Selection of TURBO/SLEEP function is possible



BLOW

It is an anti-mold function, by default it is always ON in your air conditioner.

Whenever the indoor coil has moisture, this function automatically dries up the indoor coil before going into



*Display content or the position may be different from the above graphics, please refer to actual product. Asterisk * marked function are optional and available in selected models only.*

OFF/Standby state. During this period, a reverse counter of 60 s will start, horizontal louver will be slightly open, and fan will run to dry out the indoor coil. After the counter set to zero, fan will stop, and horizontal louver will close fully.



*HUMIDITY/HUMICON

This is a refined function to control humidity and temp, maintain a comfortable ambient at indoor side. To enable this feature press HUMIDITY button from your remote handset.

When HUMIDITY function is set, Fan will work automatically, preferred set temp. Will set to 24 °C and ↑ icon will illuminate in remote handset display.

HUMIDITY selection in different modes and function.

MY MODE / 5-IN-1/ 6-in-1/CONSTANT	Selection of HUMIDITY function is not possible.
AUTO/COOL/DRY/FAN/HEAT	Selection of HUMIDITY function is possible. User can set temperature between 22 °C to 26 °C
SLEEP/TURBO/ECO	Selection of HUMIDITY is possible and SLEEP/TURBO/ECO function will exit.

 Note: HUMIDITY is an optional feature and available in selected models only.



Display content or the position may be different from the above graphics, please refer to actual product. Asterisk * marked function are optional and available in selected models only.

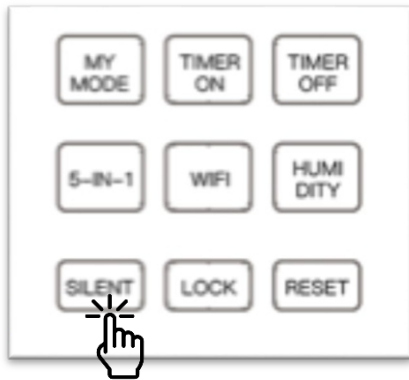

SILENT

Use the SILENT function to reduce indoor side operation noise. Press *SILENT button from your remote handset to enable this function. When silent function is set, air conditioner indoor will run in lowest speed. Silent speed can also be selected from FAN button (remote handset without SILENT button).

When SILENT function is set, SILENT icon will illuminate in remote handset display.

SILENT function will exit by pressing the SILENT button again or by changing the fan speed.

SILENT selection in different modes and function.

AUTO/DRY/MY MODE/ ECO/HUMIDITY	Selection of Silent function is not possible.
COOL/FAN/HEAT/SLEEP/ 5-IN-1/6-in-1/CONSTANT	Selection of Silent function is possible.
TURBO	Selection of Silent is possible and TURBO function will exit.



*Display content or the position may be different from the above graphics, please refer to actual product. Asterisk * marked function are optional and available in selected models only.*

*WIFI

Your air conditioner is WIFI ready. Press WIFI button on your remote handset to turn on pairing mode in your air conditioner. In remote type C & D, press and hold TURBO and FAN button together continuously for 5 s to put unit in On-boarding state.



WIFI icon on your remote handset will illuminate for some time.



Note: In-built WIFI is an optional feature and available in selected models only.

* PM_{2.5}

The degree of impurity in the indoor air is detected using a dust sensor.

PM_{2.5} button is to check PM_{2.5} level inside the room.

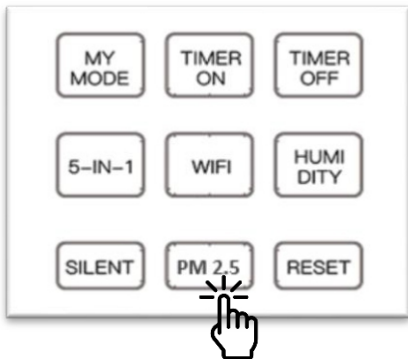

Press PM_{2.5} button for single time, actual PM_{2.5} value will appear on indoor display panel. IONIZER/PLASMA SHIELD will activate in background to help in reduction in PM_{2.5} level.



If you do not want air purification operation, Press and hold PM_{2.5} button continuously to stop function. Until you turn off the product and turn on it again,



*Display content or the position may be different from the above graphics, please refer to actual product. Asterisk * marked function are optional and available in selected models only.*

air purification operation is not operated automatically.



You can see the actual PM_{2.5} level on Indoor panel 3-digit digital display and respective indication color will be displayed on  icon.

NOTE:

- Do not touch the product while it is purifying the air. (Anion produced by a dust collection ionizer can generate static electricity.)
- Keep metal objects away from the appliance. (Anion produced by a dust collection ionizer can generate static electricity.)
- Dust concentrations may fluctuate based on changes in the indoor environment.
- The difference between the displayed dust concentration and the actual dust concentration may widen if the dust concentration is large.
- Dust levels can be measured as high in environments with external air inflow, such as at a door, window, or ventilation gate.
- Even in the same space, due to the air circulation, dust concentration may be displayed differently from other products.
- Cleaning the dust sensor/dust filter on a regular basis will keep the measured values with less variance.
- The concentration of dust may vary depending on the surrounding environment. (A construction site, a roadway, an industry, and so on.)
- Dust concentrations may fluctuate if products that generate steam or fine particles like smoke generator, humidifiers, cooking apparatus, sprays, etc. are operated nearby.
- Depending on the installation environment, dust concentrations may vary. Bugs, cleaners, humidity, smoke, insects, pets, and other factors have an effect.
- The dust concentration displayed on the product may differ Central Pollution Control Board, Ministry of Environment, Forest and Climate Change announcement, as well as from other measurement equipment or product measurement standards.
- The readings shown by the product may vary and are indicative.



Display content or the position may be different from the above graphics, please refer to actual product. Asterisk * marked function are optional and available in selected models only.

ZONE wise color indication

PM _{2.5} ICON Indication	Level	3-Digit Segment IDU Display
Green	≤ 60	Actual Value (0-60) on IDU Display
Blue	≥61 to ≤120	Actual Value (61-120) on IDU Display
Orange	≥121 to ≤250	Actual Value (121-250) on IDU Display
Red	>250+	PLS on IDU Display

PM_{2.5} Sensor cleaning

Step 1: Open Indoor front panel and locate PM_{2.5} sensor. (Refer below image)

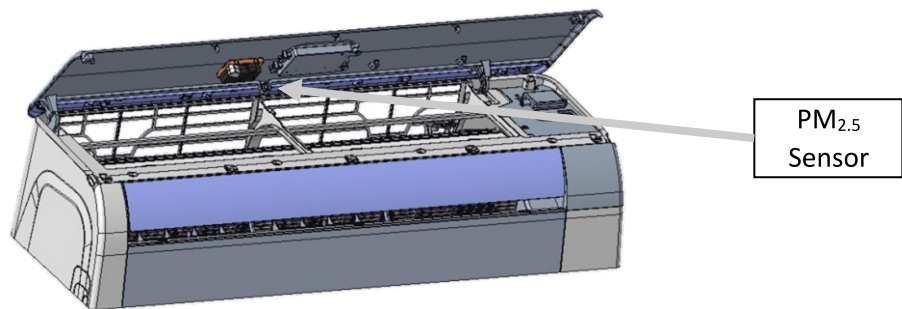

Step 2: Remove the sensor from sensor holder.

Step 3: Using a wet cotton swab, wipe the lens. Cleaning it again with a dry cotton swab to remove moisture.

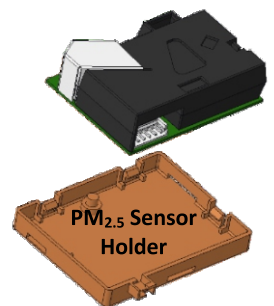
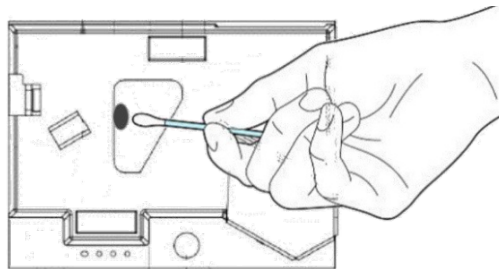

PM_{2.5} selection in different modes and function.

AUTO/COOL/DRY/FAN/HEAT/MY MODE/TURBO/ ECO/HUMIDITY/ 5-In-1/Remote Standby Mode	Selection of PM _{2.5} function is possible.
--------------------------------------------------------------------------------------	------------------------------------------------------



Note: This function is available in selected models only. Actual PM_{2.5} levels are the average of the previous 30 minutes tested under standard lab condition. The outcome may vary depending on the size and condition of the room. There will be devices-to-device differences that can be seen. PM_{2.5} Sensor, IONIZER/ Plasma Shield will perform best at 35% ~85% humidity level.



*Display content or the position may be different from the above graphics, please refer to actual product. Asterisk * marked function are optional and available in selected models only.*



*INTELLIGENT DIAGNOSTIC

Your air conditioner is smart enough to diagnose and predict errors and faults.

You can turn on Intelligent Diagnosis using your remote. Press DISPLAY button six time to initiate diagnostic. All indication on indoor hidden display panel will start blinking and in side display all LEDS on indoor side display will start blinking and the buzzer will beep four times. Press DISPLAY button again for twice or press emergency button to start this function. If Emergency / Display / Light Button not pressed with in next three-minute, Unit will go back to normal mode.

- Once test successfully completed, OK code 90 will be displayed on indoor hidden display.
- If test is unsuccessful, not OK code n9 will be displayed on indoor hidden display.
- Once test successfully completed, following information will be available on Indoor side display.
- Timer LED (GREEN) will glow continuously until Power Reset or Power ON from Remote Handset.
- Buzzer in indoor unit will beep for long duration.
- If any of the test functions are not good, NG code will activate following information will be available on Indoor side display;
- Sleep LED (RED) will continuously blink as per the error code until the error is reset or Power Reset.
- Buzzer in indoor unit will beep for 5 times



Note: Intelligent Diagnosis is an optional feature and available in selected models only.

If the air conditioner working previously. Turn the air conditioner OFF for five minute and turn it ON.

MEMORY

During power failure, air conditioner will remember last setting and function like Set temp, Mode, Fan speed, Swing position, Silent, WIFI will resume after power supply recover.



*Display content or the position may be different from the above graphics, please refer to actual product. Asterisk * marked function are optional and available in selected models only.*

EMERGENCY/AUX. BUTTON

During loss of remote handset, you can turn ON/OFF your air conditioner using emergency or auxiliary button available on indoor side unit. Air conditioner will operate in AUTO mode as preset temperature 24 degree C and fan will set to Auto. Swing will set to Auto Swing.



Defrost (Cooling/Heating)

COOLING (P7/DF)

When the indoor side coil temperature is very low and the humidity is very high, frost may develop and appear on the coil, which may decrease cooling efficiency. When these conditions are met while running in Cool mode, the air conditioner runs the defrost function for some time to remove frost from the heat exchanger. During this time dF or P7 indication will be displayed on indoor display panel.



HEATING

When the outdoor side temperature is low and the humidity is high, frost may develop and appear on the outdoor coil, which may decrease heating efficiency. When these conditions are met while running in Heat mode, the air conditioner runs the Defrost function for some time to remove frost from the heat exchanger.



*Display content or the position may be different from the above graphics, please refer to actual product. Asterisk * marked function are optional and available in selected models only.*

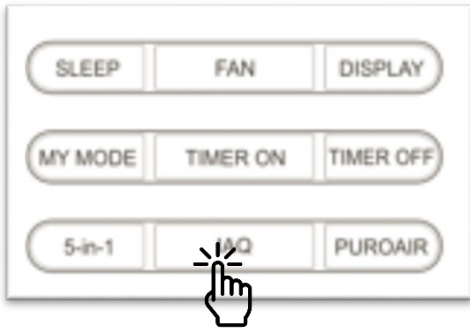

***IAQ**

The degree of impurity in the indoor air is detected using a Gas sensor.

IAQ button is to check IAQ and PM_{2.5} levels of air quality inside the room.

IAQ BUTTON will work as a toggle switch between IAQ and PM_{2.5}.

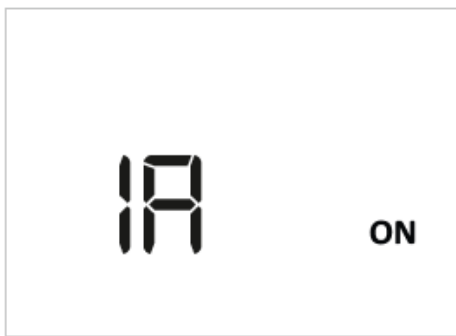

Press IAQ button for single time, real time IAQ value will appear on indoor display panel and IA ON will appear on remote display for 5 s. IAQ button will not work during 5 s.

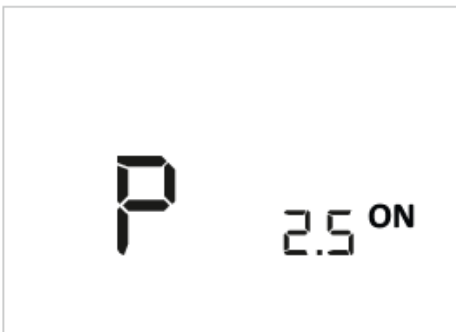

After 5s Press the IAQ button again to show PM_{2.5} value on indoor display panel and P 2.5 ON will appear on remote display for 5 s. IAQ button will not work during 5 s.



*Display content or the position may be different from the above graphics, please refer to actual product. Asterisk * marked function are optional and available in selected models only.*



You can see the real time IAQ, PM_{2.5} values on center Indoor display panel in 3-digit respective.





Color Indication based on IAQ and PM_{2.5} will be displayed on the multicolored side display.

IONIZER/PLASMA SHIELD will activate automatically to help in reduction in PM_{2.5} level and IAQ level. IDU display Home icon will indicate the ON/OFF operation of Ionizer/Plasma shield. Home Icon will glow green when Ionizer /Plasma will turn ON.

ZONE wise color indication

Color Indication	PM _{2.5} Level	IAQ Values (3-Digit Segment Display)
Green	≤60	Actual Value (0-100) on IDU Display
Yellow	≥61 to ≤90	Actual Value (101-200) on IDU Display
Blue	≥91 to ≤120	Actual Value (201-300) on IDU Display
Red	>250+	Actual Value (301-500) on IDU Display

NOTE:

-  Do not touch the product while it is purifying the air. (Anion produced by a dust collection ionizer can generate static electricity.)
-  Keep metal objects away from the appliance. (Anion produced by a dust collection ionizer can generate static electricity.)

- Dust levels can be measured as high in environments with external air inflow, such as at a door, window, or ventilation gate.
- Even in the same space, due to the air circulation, dust concentration may be displayed differently from other products.
- Cleaning the dust sensor/dust filter on a regular basis will keep the measured values with less variance.



Display content or the position may be different from the above graphics, please refer to actual product. Asterisk * marked function are optional and available in selected models only.

- At every power ON from supply, gas sensor will initialize and self-calibrate for some initial time.
- Dust concentrations may fluctuate based on changes in the indoor environment.
- The difference between the displayed dust concentration and the actual dust concentration may widen if the dust concentration is large.
- Sensor can detect e.g. outgassing from paint, furniture, garbage, high VOC levels due to cooking, food consumption, exhaled breath and sweating
- The concentration of dust may vary depending on the surrounding environment. (A construction site, a roadway, an industry, and so on.)
- Dust concentrations may fluctuate if products that generate steam or fine particles like smoke generator, humidifiers, cooking apparatus, sprays, etc. are operated nearby.
- Depending on the installation environment, dust concentrations may vary. Bugs, cleaners, humidity, smoke, insects, pets, and other factors have an effect.
- The dust concentration displayed on the product may differ Central Pollution Control Board, Ministry of Environment, Forest and Climate Change announcement, as well as from other measurement equipment or product measurement standards.
- The readings shown by the product may vary and are indicative.
- The information obtained from this device is only for informational purposes; it should not be regarded as a medical device.

AQI selection in different modes and function.

AUTO/COOL/DRY/FAN/HEAT/TURBO/ ECO/HUMIDITY/ 5-In-1/6-in-1	Selection of AQI function is possible.
MY MODE/ STAND BY STATE	Selection of AQI function is not possible

PUROAIR- “Pur” (Specially for Winter Season in Cool only models)

In Cool mode press PUROAIR Button six time continuously within 10 s to enter into Pur mode. IDU display will show Pur for 5 s after entering in the Pur Mode and side display will show color in cyclic order. Fan Speed and Swing (V/H) will set to default mode setting. During Pur mode Outdoor will not work.*Single press of PUROAIR button will enter into Humidity mode.



During PUR mode below Keys will operate:-

- FAN - Press FAN button to select different fan speed.



*Display content or the position may be different from the above graphics, please refer to actual product. Asterisk * marked function are optional and available in selected models only.*

- TURBO- Press TURBO button to start the fast filtration process.
- SLEEP- Press SLEEP button from the remote handset to activate sleep function.
- TIMER- Press Timer OFF button to set OFF timer. PUR mode exit when timer activate.
- V/H SWING- Press V/H swing button to select desire swing position.
- DISPLAY- Press display button to turn OFF displays on IDU panel.
- POWER- Press Power button to turn OFF PUR mode. PUR mode will also exit when power supply is cut.

IAQ Sensor Cleaning

When the indoor unit displays the CL indicator

Step 1: Open Indoor front panel and locate IAQ sensor. (Refer below image)

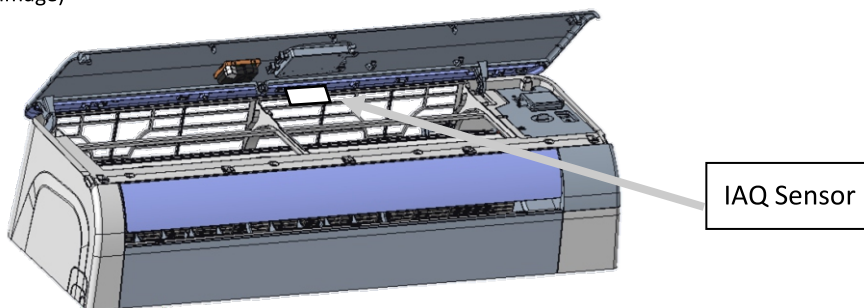

Step 2: Remove the IAQ sensor holder.

Step 3: Clean the sensor with a cotton swab. (Do not touch the PCB.)



*Display content or the position may be different from the above graphics, please refer to actual product. Asterisk * marked function are optional and available in selected models only.*

Note:

- When the humidity level in the room is extremely high, condensation may form on the Gas Sensors. As a result, even if the air quality is good, the air quality light may indicate that it is poor. You must either clean the Gas Sensors or run your air conditioner in DRY/HUMIDITY.
- For optimal purifier performance, clean the gas sensors whenever the CL indicator appears on the display. If you use the purifier in a dusty environment, clean it more frequently.

PUROAIR selection in different modes and function.

MY MODE / 5-IN-1/6-in-1/AUTO/DRY/FAN/HUMIDITY/ECO	Selection of PUROAIR function is not possible.
COOL/HEAT	Selection of PUROAIR function is possible.
PUROAIR	Selection of TURBO/SLEEP function is possible

Operation of “IAQ” in “Havells Sync” Application

IAQ Information

- Change in Indoor Air Quality will automatically appear on an APP screen.

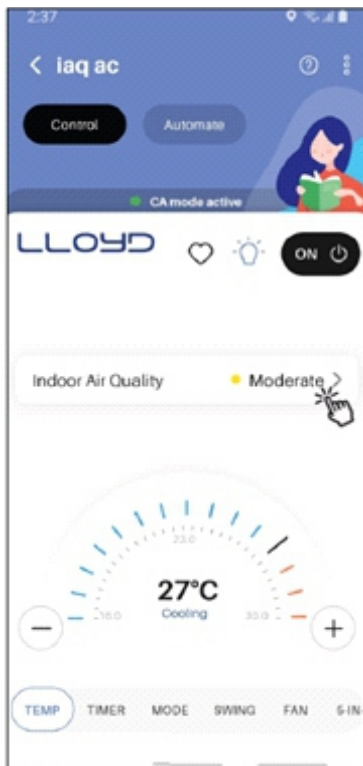

1. On home page check Indoor Air Quality and click Indoor Air quality tab.

2. Check IAQ in details. Click on back button “<” to go Home page.



*Display content or the position may be different from the above graphics, please refer to actual product. Asterisk * marked function are optional and available in selected models only.*

*ODVA module operation

*Hello Lloyd! ON-Device-Voice Assistance (ODVA) module operation.

ON-Device-Voice Assistance (ODVA) module is designed to have a great user experience.

Wake words and indicator

Talking to your Air Conditioner

“Hello Lloyd” is the word you say to get the attention of air conditioner. Say the wake word and the air conditioner do what you say. After wake word, hi will come on 7 segment display and let you know that device is ready to listen to your command.

Microphones

- ✓ Area near the microphone should be obstacle free for the best performance.
- ✓ The voice command must be invoked from a distance of maximum *eight meters when the indoor unit is installed 7ft (213.36 cm) height.
**Disclaimer: Test conducted under low noise level under HIL lab.*
- ✓ ODV Assistance can take different voice from the age range from eight to eighty years.
- ✓ Keeping a small pause between wake word and command is recommended.



*Display content or the position may be different from the above graphics, please refer to actual product. Asterisk * marked function are optional and available in selected models only.*

- ✓ Once the wake word Hello Lloyd is said and no command is given, it is recommended to wait for five to seven seconds for timeout period.
- ✓ It is highly recommended to say commands in a proper manner for faster response.
- ✓ **Pros and Cons in Speech Recognition Technology**
- ✓ **There are many pros while using ODV assistance module;**
- ✓ More user friendly.
- ✓ Easy to use and readily available
- ✓ Can use this ODV module without internet/WIFI
- ✓ **The technology consists of some cons such as:**
- ✓ Inability to capture words due to variations of pronunciation.
- ✓ Lack of support for most languages other than English.
- ✓ Inability to sort through background noise.

Set up your ODV assistance module.

- Turn ON Air conditioner
- ODVA module will take 5 s for initialization.
- It is required to say the Wake word, to listen to your command.
- After wake word, wait for a second and then give a command.
- If gap between the awake word and command is of 5 s or more then command will not execute.
- Timeout of execution of command will occur.

Things to Try

Things to Try guide provides examples of things you can ask your air conditioner. Keep this card to help you get started.



*Display content or the position may be different from the above graphics, please refer to actual product. Asterisk * marked function are optional and available in selected models only.*

- **Power Control**

Hello Lloyd, Turn On

Hello Lloyd, Turn OFF

- **Temperature Control**

Hello Lloyd, Increase Temperature

Hello Lloyd, Reduce Temperature

- **Mode Control**

Hello Lloyd, Auto Mode

Hello Lloyd, Cool Mode

Hello Lloyd, Dry Mode

Hello Lloyd, Heat Mode (Only in Heat-Cool Models)

- **Fan Speed Control**

Hello Lloyd, Reduce Fan Speed

Hello Lloyd, Increase Fan Speed

- Fan speed can be control minimum to maximum.

- Fan speed on IDU hidden display will appear as below;

Silent (1F) → Low (2F) → Med (3F) → High (4F) → Turbo (5F)

Center Indoor display panel for ODV commands.

Say the wake word “**Hello Lloyd**”, on IDU hidden display “**hi**” will come on 7 segment display will let you know that device is ready to listen to your Command and for a specific interval.



*Display content or the position may be different from the above graphics, please refer to actual product. Asterisk * marked function are optional and available in selected models only.*

Note:-

- *If defined command doesn't execute or command time out occur then buzzer will beep for 3 times.*
- *ODV must operate in a less noisy environment in order to function properly; otherwise, we will see malfunction.*
- *Say commands in a proper manner for faster response and give small pause between wake word and command is recommended.*
- *Only use mentioned commands to device.*
- *If we use commands that are not advised, the device may malfunction.*



*Display content or the position may be different from the above graphics, please refer to actual product. Asterisk * marked function are optional and available in selected models only.*

ERRORS & TROUBLESHOOTING

Inverter Split Air Conditioner

Cases	Outdoor Light Flashes	Indoor LED Flashes	Indoor Display	Fault Details
Fault	25	25	EE	Indoor machine EE fault
	1	1	E0	Outdoor EE fault
	26	26	E1	Indoor fan fault
	27	27	E2	Indoor fan zero-crossing detection abnormal
	28	28	E3	Indoor coil fault and sensor fault
	29	29	E4	Indoor ambient temperature sensor fault
	30	30	E5	Refrigerant Leak fault <i>(Optional)</i>
	2	2	E6	Indoor and outdoor machine communication fault
	/	3	E9 / EF	WiFi module fault <i>(Optional)</i>
	24	24	EH	Humidity sensor fault <i>(Optional)</i>
	/	37	EP	PM _{2.5} sensor fault <i>(Optional)</i>
	/	38	EU	Voice module communication fault <i>(Optional)</i>
	/	/	CL	Filter Cleaning Reminder indication <i>(Optional)</i>
	/	/	go	Good to Go <i>(Optional)</i>
	/	/	ng	Not good to Go <i>(Optional)</i>
	4	4	F1	Compressor starting abnormal /Phase failure
	5	5	F2	Compressor out-of-step fault
	6	6	F3	IPM module fault
	7	7	F4	Compressor shell roof fault/protection
	8	8	F5	Discharge temperature sensor fault
9	9	F6	Suction temperature sensor fault <i>(Optional)</i>	
10	10	F7	Outdoor coil temperature sensor fault	
11	11	F8	Outdoor ambient temperature sensor fault	
12	12	F9	Outdoor DC fan fault <i>(Optional)</i>	
Protection	13	13	P1	Outdoor machine AC current protection
	14	14	P2	Compressor phase current protection
	15	15	P3	Outdoor unit over-high/over-low AC voltage protection
	16	16	P4	DC voltage over-high or over-low voltage protection
	17	17	P5	IPM over-high temperature protection
	18	18	P6	Discharge temperature overheat protection
	19	19	P7	Cooling indoor coil anti-freezing protection
	20	20	P8	Cooling outdoor coil overheat protection
	21	21	P9	Heating indoor coil overheat protection <i>(Optional)</i>
	22	22	PC	Cooling outdoor ambient temperature over-low protection
23	23	PH	Heating outdoor ambient temperature over-high protection <i>(Optional)</i>	
31	31	L1	Drive bus voltage over-high protection	
32	32	L2	Drive bus voltage over-low protection	
Fault	33	33	L3	Drive phase current overload fault
	34	34	L4	Phase current sampling abnormal
Indication	/	/	Ht	Heat Mode Indication

Split Air Conditioner

Fault	/	29	E1	Indoor side room temperature sensor fault
	/	28	E2	Indoor side coil temperature sensor fault
	/	26	E5 / H6	Indoor side fan motor fault
	/	19	dF	Indoor side defrost protection – Cooling
	/		E3	Outdoor side coil temperature sensor fault <i>(Optional)</i>
			21	HP
			HF	Outdoor side defrost protection – Heating <i>(Optional)</i>
Indication	/	/	Ht	Heat Mode Indication



Note: * Check the LED light flashed from second cycle.



Display content or the position may be different from the above graphics, please refer to actual product. Asterisk* marked function are optional and available in selected models only. The company reserves the right to change/modify in the content time to time.

Replacement of batteries in remote controller

1. Press the back side of remote controller marked with "OPEN", as shown in the fig, and then push out the cover of battery box along the arrow direction.
2. Replace two (AAA 1.5 V) dry batteries, and make sure the position of "+" polar and "-" polar are correct.
3. Reinstall the cover of battery box.

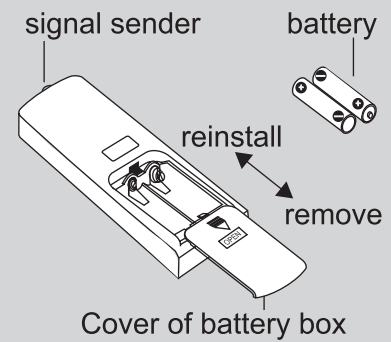

NOTICE

- During operation, point the remote control signal sender at the receiving window on indoor unit.
- The distance between signal sender and receiving window should be not more than 8 m, and there should be no obstacles between them.
- Signal may be interfered easily in the room where there is fluorescent lamp or wireless telephone; remote controller should be close to indoor unit during operation.
- Replace new batteries of the same model when replacement is required.
- When you don't use remote controller for a long time, please take out the batteries.
- If the display on remote controller is fuzzy or there's no display, please replace batteries.

Emergency operation

If remote controller is lost or damaged, please use emergency operation switch to turn on or turn off the air conditioner. The operation in details are as below: As shown in the fig. Open panel, press emergency operation switch to turn on or turn off the air conditioner. When the air conditioner is turned on, it will operate under auto mode. Press the emergency operation switch again to turn the unit off.

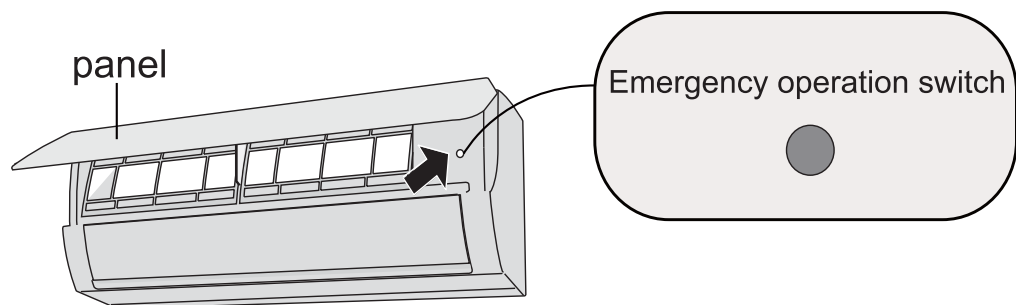

WARNING:

Use insulated object to press the emergency operation switch.

Clean and maintenance

WARNING

- Turn off the air conditioner and disconnect the power before cleaning the air conditioner to avoid electric shock.
- Do not wash the air conditioner with water to avoid electric shock.
- Do not use volatile liquid to clean the air conditioner.

Clean surface of indoor unit

When the surface of indoor unit is dirty, it is recommended to use a soft dry cloth or wet cloth to wipe it.

NOTICE:

- Do not remove the panel when cleaning it.

Clean and maintenance

Clean filter

1 Open panel

Pull out the panel to a certain angle as shown in the fig.

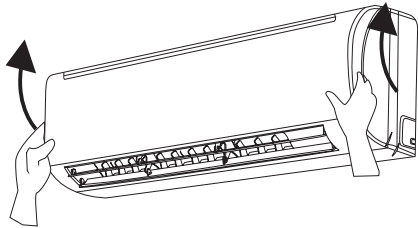

2 Remove filter

Remove the filter as indicated in the fig.

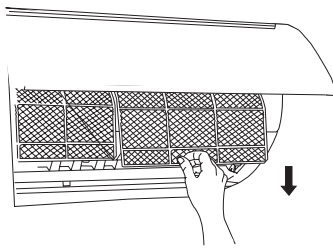

3 Clean filter

- Use dust catcher or water to clean the filter.
- When the filter is very dirty, use the water (below 45°C) to clean it, and then put it in a shady and cool place to dry.

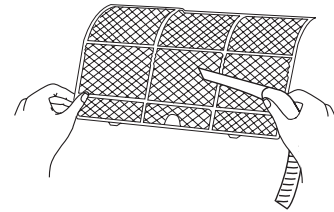

4 Install filter

Install the filter and then close the panel cover tightly.

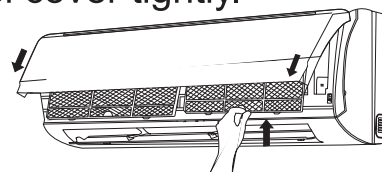

WARNING

- The filter should be cleaned every three months. If there is much dust in the operation environment, clean frequency can be increased.
- After removing the filter, do not touch fins to avoid injury.
- Do not use fire or hair dryer to dry the filter to avoid deformation or fire hazard.

Clean and maintenance

NOTICE: Checking before use-season

1. Check whether air inlets and air outlets are blocked.
2. Check whether circuit break, plug and socket are in good condition.
3. Check whether filter is clean.
4. Check whether mounting bracket for outdoor unit is damaged or corroded.
If yes, please contact dealer.
5. Check whether drainage pipe is damaged.

NOTICE: Checking after use-season

1. Disconnect power supply.
2. Clean filter and indoor unit's panel.
3. Check whether mounting bracket for outdoor unit is damaged or corroded.
If yes, please contact dealer.

Notice for recovery

1. Many packing materials are recyclable materials.
Please dispose them in appropriate recycling unit.
2. If you want to dispose the air conditioner, please contact us on our Toll Free Numbers.

Malfunction analysis

General phenomenon analysis

Please check below items before asking for maintenance. If the malfunction still can't be eliminated, please contact local dealer or qualified professionals.

Phenomenon	Check items	Solution
Indoor unit can't receive remote controller's signal or remote controller has no action.	<ul style="list-style-type: none"> Whether it's interfered severely (such as static electricity, stable voltage)? 	<ul style="list-style-type: none"> Pull out the plug. Reinsert the plug after about 3 min, and then turn on the unit again.
	<ul style="list-style-type: none"> Whether remote controller is within the signal receiving range? 	<ul style="list-style-type: none"> Signal receiving range is 8 m
	<ul style="list-style-type: none"> Whether there are obstacles? 	<ul style="list-style-type: none"> Remove obstacles.
	<ul style="list-style-type: none"> Whether remote controller is pointing at the receiving window? 	<ul style="list-style-type: none"> Select proper angle and point the remote controller at the receiving window on indoor unit.
	<ul style="list-style-type: none"> Is sensitivity of remote handset low, fuzzy display, back light flickering, back light turning of during button press & no display ? 	<ul style="list-style-type: none"> Check the batteries. If the power of batteries is too low, please replace them.
	<ul style="list-style-type: none"> No display when operating remote controller? 	<ul style="list-style-type: none"> Check whether remote controller appears to be damaged. If yes, replace it.
	<ul style="list-style-type: none"> Fluorescent lamp in room? 	<ul style="list-style-type: none"> Take the remote controller close to indoor unit. Turn off the fluorescent lamp and then try it again,
No air emitted from indoor unit	<ul style="list-style-type: none"> Air inlet or air outlet of indoor unit is blocked? 	<ul style="list-style-type: none"> Eliminate obstacles.
	<ul style="list-style-type: none"> Under heating mode, indoor temperature is reached to set temperature? 	<ul style="list-style-type: none"> After reaching to set temperature, indoor unit will stop blowing out air.
	<ul style="list-style-type: none"> Heating mode is turned on just now? 	<ul style="list-style-type: none"> In order to prevent blowing out cold air, indoor unit will be started after delaying for several minutes, which is a normal phenomenon.

Malfunction analysis

Phenomenon	Check items	Solution
Air conditioner can't operate	● Power failure?	● Wait until power recovery.
	● Is plug loose?	● Reinsert the plug.
	● Circuit break trips off or fuse is burnt out?	● Ask professional to replace circuit break or fuse.
	● Wiring has malfunction?	● Ask professional to replace it.
	● Unit has restarted immediately after stopping operation?	● Wait for 3 min, and then turn on the unit again.
	● Whether the function setting for remote controller is correct?	● Reset the function.
Mist is emitted from indoor unit's air outlet	● Indoor temperature and humidity is high?	● Because indoor air is cooled rapidly. After a while, indoor temperature and humidity will be decrease and mist will disappear.
Set temperature can't be adjusted	● Unit is operating under auto mode?	● Temperature can't be adjusted under auto mode. Please switch the operation mode if you need to adjust temperature.
	● Your required temperature exceeds the set temperature range?	● Set temperature range: 16 °C ~ 30 °C .
Cooling (heating) effect is not good.	● Voltage is too low?	● Wait until the voltage resumes normal.
	● Filter is dirty?	● Clean the filter.
	● Set temperature is in proper range?	● Adjust temperature to proper range.
	● Door and window are open?	● Close door and window.

Malfunction analysis

Phenomenon	Check items	Solution
Odours are emitted	<ul style="list-style-type: none">• Whether there's odour source, such as furniture and cigarette, etc.	<ul style="list-style-type: none">• Eliminate the odour source.• Clean the filter.
Air conditioner operates abnormally	<ul style="list-style-type: none">• Whether there's interference, such as thunder, wireless devices, etc.	<ul style="list-style-type: none">• Disconnect power, put back power, and then turn on the unit again.
Outdoor unit has vapor	<ul style="list-style-type: none">• Heating mode is turned on?	<ul style="list-style-type: none">• During defrosting under heating mode, it may generate vapor, which is a normal phenomenon.
"Water flowing" noise	<ul style="list-style-type: none">• Air conditioner is turned on or turned off just now?	<ul style="list-style-type: none">• The noise is the sound of refrigerant flowing inside the unit, which is a normal phenomenon.
Cracking noise	<ul style="list-style-type: none">• Air conditioner is turned on or turned off just now?	<ul style="list-style-type: none">• This is the sound of friction caused by expansion and/or contraction of panel or other parts due to the change of temperature.

Installation dimension diagram

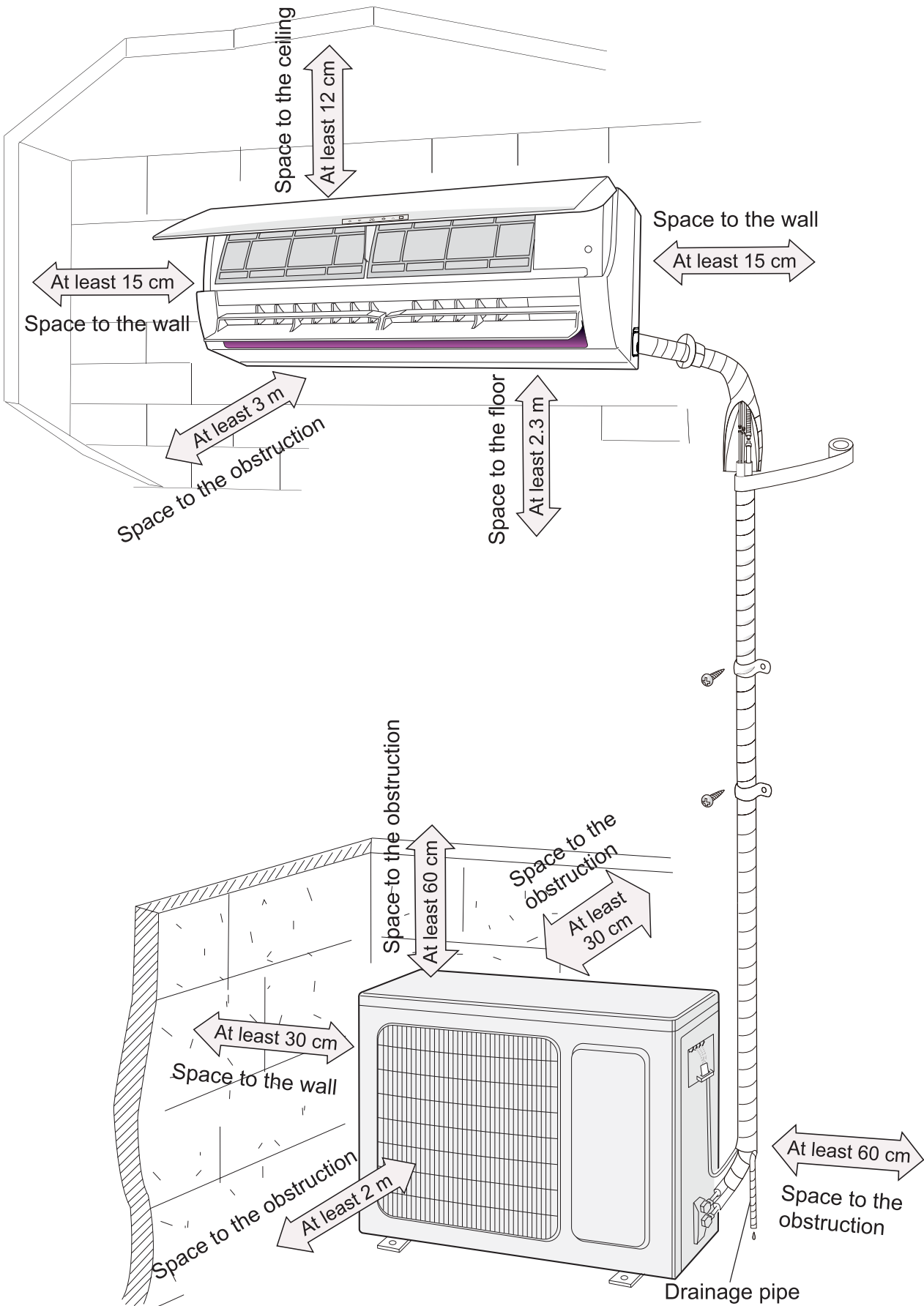

Tools for installation

1 Level meter	2 Screw driver	3 Impact drill
4 Drill head	5 Pipe expander	6 Torque wrench
7 Open-end wrench	8 Pipe cutter	9 Leakage detector
10 Vacuum pump	11 Pressure meter	12 Universal meter
13 Inner hexagon spanner		14 Measuring tape

Note:

- Please contact us on our Toll Free Number.
- Don't use unqualified power cord.

Selection of installation location

Basic requirement

Installing the unit in the following place may cause malfunction. if it is unavoidable, please consult the local dealer:

- 1.The place with strong heat sources, vapors, flammable or explosive gas, or volatile objects spread in the air.
- 2.The place with high-frequency devices (such as welding machine, medical equipment).
- 3.The place near coast area.
- 4.The place with oil or fumes in the air.
- 5.The place with sulphurated gas.
- 6.Other places with special circumstances.
- 7.Do not use the unit in the immediate surroundings of a laundry a bath a shower or a swimming pool.

Indoor unit

1. There should be no obstruction near air inlet and air outlet.
2. Select a location where the condensation water can be dispersed easily and won't affect other people.
3. Select a location which is convenient to connect the outdoor unit and near the power socket.
4. Select a location which is out of reach for children.
5. The location should be able to withstand the weight of indoor unit and won't increase noise and vibration.
6. The appliance must be installed 2.5 m above floor.
7. Don't install the indoor unit right above the electric appliance.
8. Please try your best to keep way from fluorescent lamp.

Outdoor unit

1. Select a location where the noise and outflow air emitted by the outdoor unit will not affect neighborhood.
2. The location should be well ventilated and dry, in which the outdoor unit won't be exposed directly to sunlight or strong wind.
3. The location should be able to withstand the weight of outdoor unit.
4. Make sure that the installation follows the requirement of installation dimension diagram.
5. Select a location which is out of reach for children and far away from animals or plants.If it is unavoidable, please add the fence for safety purpose.

Requirements for electric connection

Safety precaution

1. Must follow the electric safety regulations when installing the unit.
2. According to the local safety regulations, use qualified power supply circuit and circuit break.
3. Make sure the power supply matches with the requirement of air conditioner. Unstable power supply or incorrect wiring. Please install proper power supply cables before using the air conditioner.
4. Properly connect the live wire, neutral wire and grounding wire of power socket.
5. Be sure to cut off the power supply before proceeding any work related to electricity and safety.
6. Do not put through the power before finishing installation /servicing
7. If the supply cord is damaged, it must be replaced by the manufacturer, its service agent or similarly qualified persons in order to avoid a hazard.
8. The temperature of refrigerant circuit will be high, please keep the interconnection cable away from the copper tube.
9. The appliance shall be installed in accordance with national wiring regulations.
10. Installation must be performed in accordance with the requirement of NEC and CEC by authorized personnel only

Grounding requirement

1. The air conditioner is the first class electric appliance. It must be properly grounded with specialized grounding device by a professional. Please make sure it is always grounded effectively, otherwise it may cause electric shock and malfunction.
2. The yellow-green wire in air conditioner is grounding wire, which can't be used for other purposes.
3. The grounding resistance should comply with national electric safety regulations.
4. The appliance must be positioned so that the plug is accessible.
5. An all-pole disconnection switch having a contact separation of at least 3 mm in all poles should be connected in fixed wiring.
6. Including a circuit break with suitable capacity, please note the following table. Air switch should be included with magnet buckle and heating buckle function, it can protect the circuit-short and overload. (Caution: please do not use the fuse only for protect the circuit)

Air-conditioner capacities	Recommended circuit break
09K (0.8 Tr)	10 A
12K (1.0 Tr)	16 A
18K, 24K (1.5-2.0 Tr)	25 A

Installation of indoor unit

Step one: choosing installation location

Recommend the installation location to the client and then confirm it with the client.

Step two: open piping hole

1. Choose the position of piping hole according to the direction of outlet pipe. The position of piping hole should be a little lower than the wall-mounted frame, shown as below.

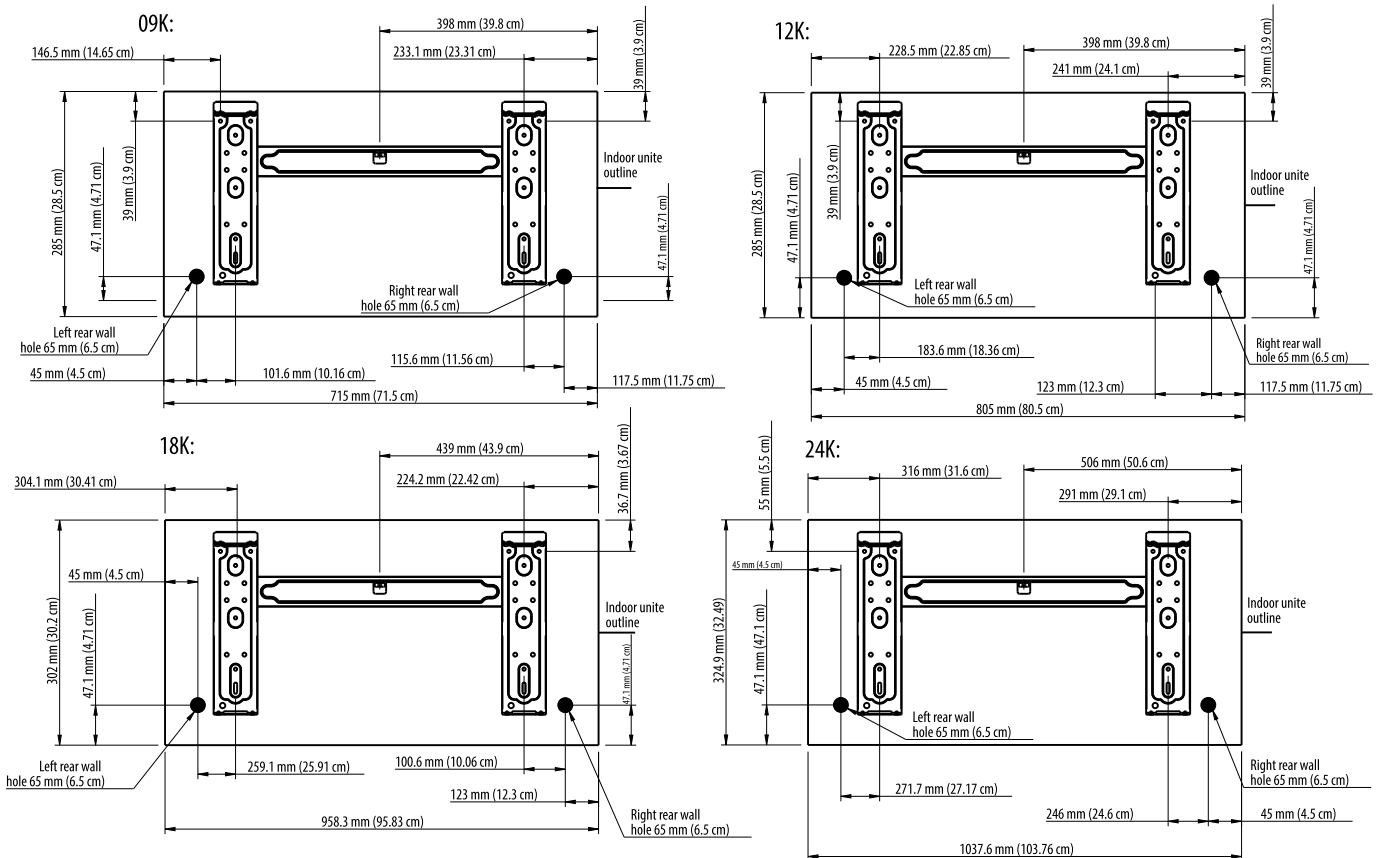

2. Using a 65 mm (6.35 cm) or 90 mm (2.29 cm) (depending) on models) core drill a hole in the wall. Make sure that the hole is drilled at a slight downward angle, so that the outdoor end of the hole is lower than the indoor end by about 5 mm to 7 mm (0.5 - 0.678 cm) This will ensure proper water drainage.

NOTE:

- When the gas side connective pipe is $\Phi 16$ mm (12.7 cm / 20.3 cm) or more, the wall hole should be 90 mm (2.29 cm).

Installation of indoor unit

Note:

- Pay attention to dust prevention and take relevant safety measures when opening the hole.
- The plastic expansion particles are not provided and should be bought locally.

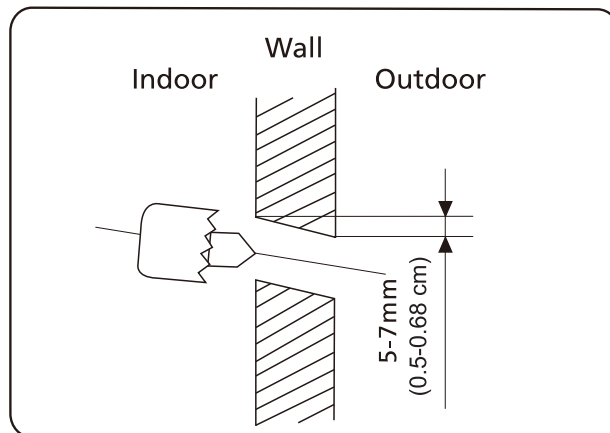

Step three: outlet pipe

1. The pipe can be led out in the direction of right, rear right, left or rear left.

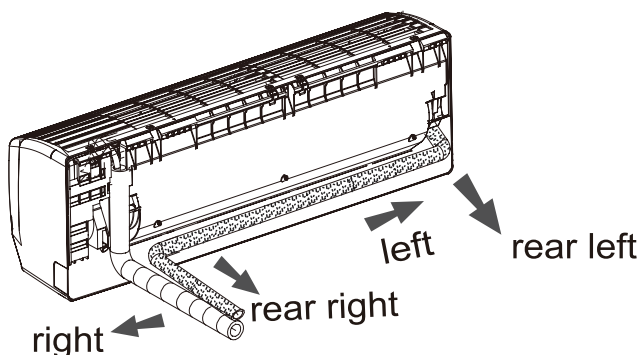

2. When select leading out the pipe from left or right, please cut off the corresponding hole on the bottom case.

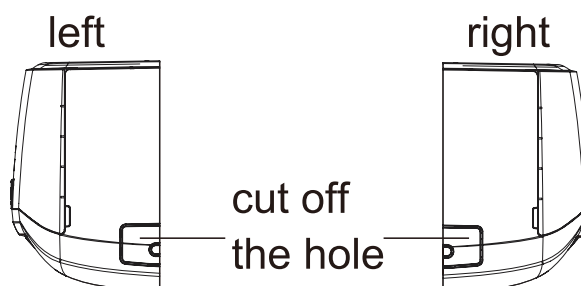

Step four: connect the pipe of indoor unit

1. Aim the pipe joint at the corresponding bellmouth.

2. Pretightening the union nut with hand.

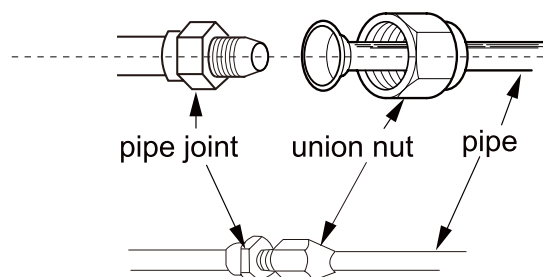

3. Adjust the torque force by referring to the following sheet. Place the open-end wrench on the pipe joint and place the torque wrench on the union nut. Tighten the union nut with torque wrench.

Installation of indoor unit

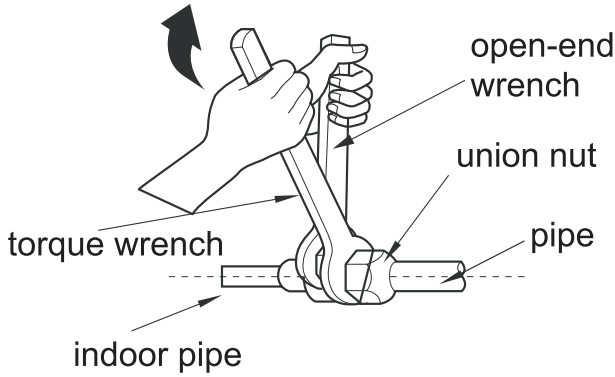

Hex nut diameter	Tightening torque (N·m)
16.4 cm (6.35)	15~20 (N.m)
24.2 cm (9.53)	30~40 (N.m)
32.2 cm (12.70)	45~55 (N.m)
40.3 cm (15.88)	60~65 (N.m)
49.5 cm (19.05)	70~75 (N.m)

4. Wrap the indoor pipe and joint of connection pipe with insulating pipe, and then wrap it with tape.

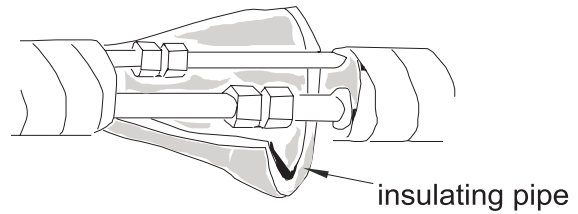

Step five: install drain hose

1. Connect the drain hose to the outlet pipe of indoor unit.

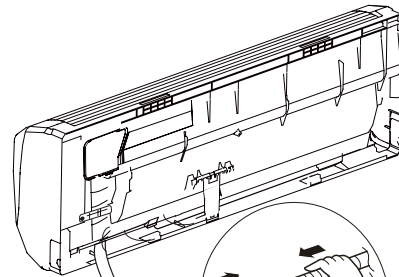

2. Bind the joint with tape.

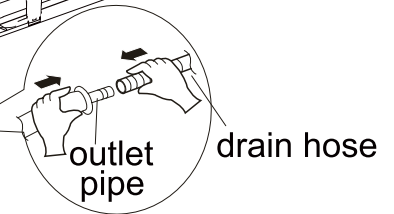
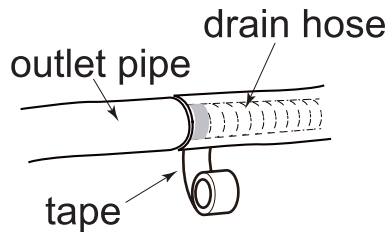

Note:

- Add insulating pipe in the indoor drain hose in order to prevent condensation.
- The plastic expansion particles are not provided.

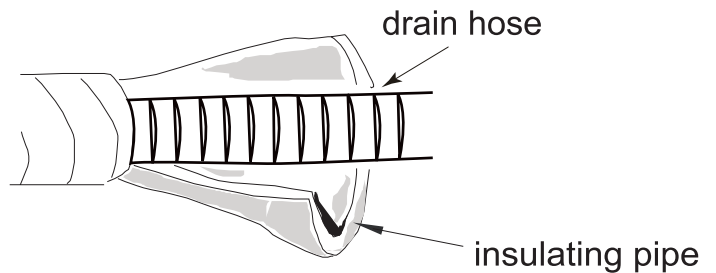

Step six: connect wire of indoor unit

1. Open the panel, remove the screw on the wiring cover and then take down the cover.

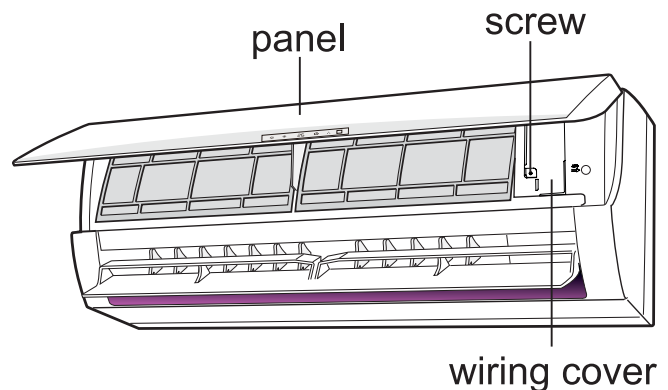

Installation of indoor unit

2. Make the power connection wire go through the slot hole at the back of indoor unit and then pull it out from the front side.

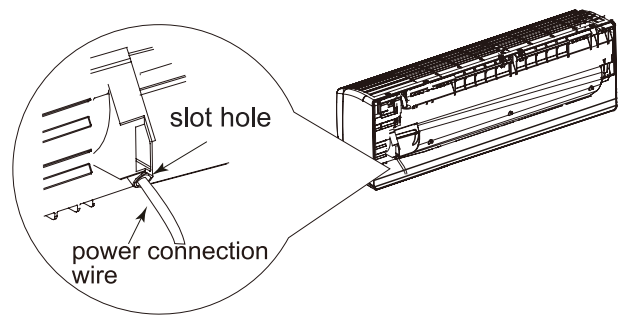

3. Remove the wire clip; connect the power connection wire to the wiring terminal according to the color; tighten the screw and then fix the power connection wire with wire clip.

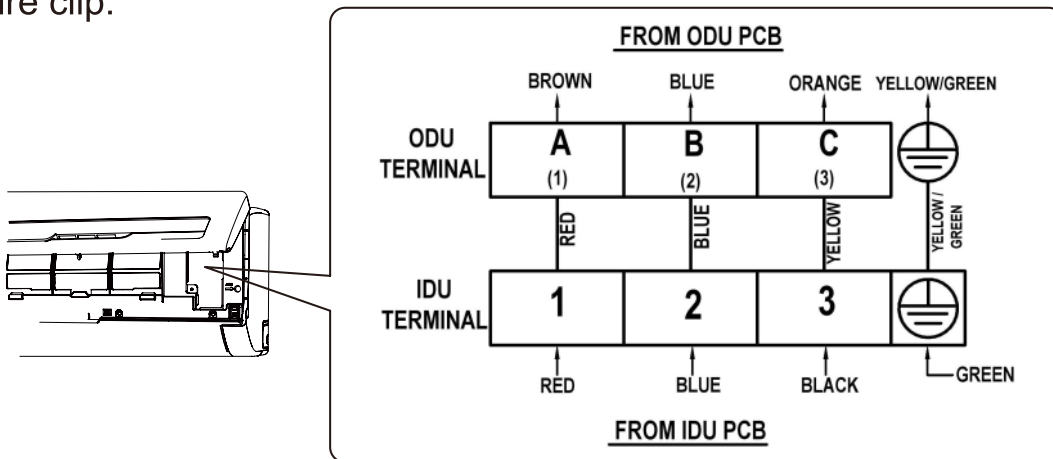

NOTE:

- Please refer to the actual wiring diagram on the unit.

4. Put wiring cover back and then tighten the screw.
5. Close the panel.

Note:

- All wires of indoor unit and outdoor unit should be connected by a professional.
- If the length of power connection wire is insufficient, please contact the supplier for a new one. Avoid extending the wire by yourself.
- For the air conditioner with plug, the plug should be reachable after finishing installation.
- For the air conditioner without plug, an circuit break must be installed in the line. The circuit break should be all-pole parting and the contact parting distance should be more than 3 mm.

Installation of indoor unit

Step seven: bind up pipe

1. Bind up the connection pipe, power cord and drain hose with the band.

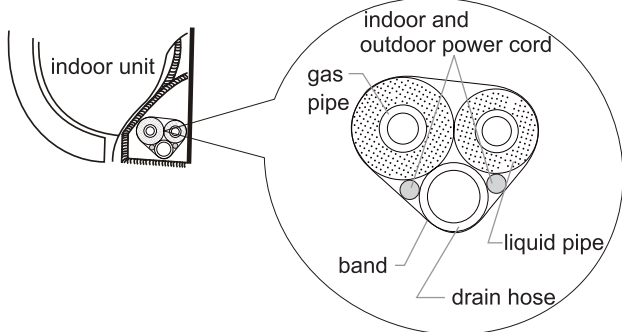

2. Reserve a certain length of drain hose and power cord for installation when binding them. When binding to a certain degree, separate the indoor power and then separate the drain hose.

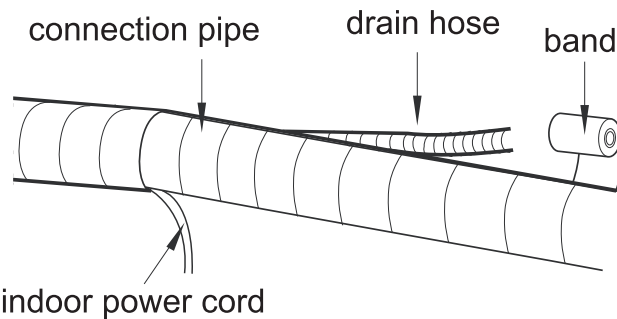

3. Bind them evenly.
4. The liquid pipe and gas pipe should be bound separately at the end.

Note:

- The power cord and control wire can't be crossed or winding.
- The drain hose should be bound at the bottom.

Step eight: hang the indoor unit

1. Put the bound pipes in the wall pipe and then make them pass through the wall hole.
2. Hang the indoor unit on the wall-mounting frame.
3. Stuff the gap between pipes and wall hole with sealing gum.
4. Fix the wall pipe.
5. Check if the indoor unit is installed firmly and closed to the wall.

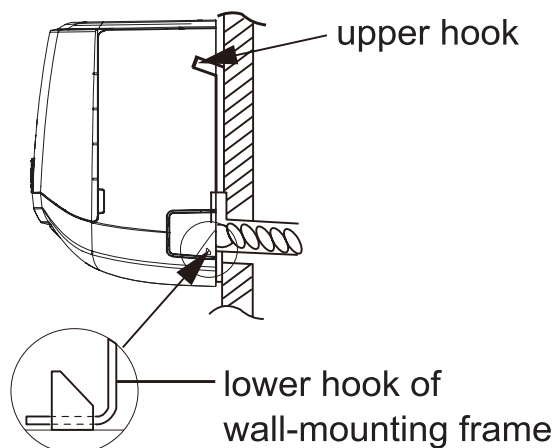
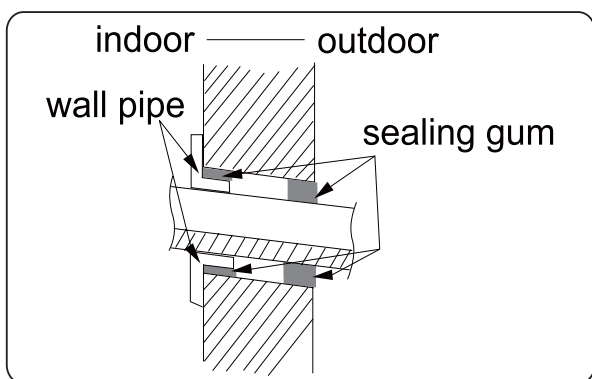

Note:

- Do not bend the drain hose too excessively in order to prevent blocking.

Installation of outdoor unit

Step one: fix the support of outdoor unit

(select it according to the actual installation situation)

1. Select installation location according to the house structure.
2. Fix the support of outdoor unit on the selected location with expansion screws.

Note:

- Take sufficient protective measures when installing the outdoor unit.
- Make sure the support can withstand at least four times of the unit weight.
- The outdoor unit should be installed at least 3 cm above the floor in order to install drain joint.

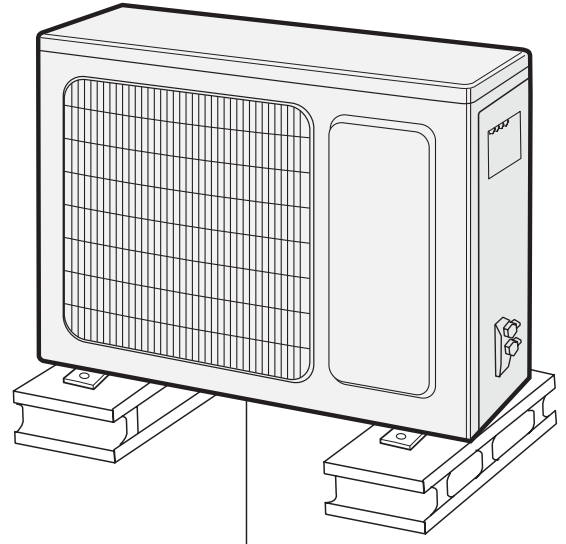

at least 3 cm above the floor

Step two: install drain joint (Only for cooling and heating unit)

1. Connect the outdoor drain joint into the hole on the chassis, as shown in the picture below.
2. Connect the drain hose into the drain vent.

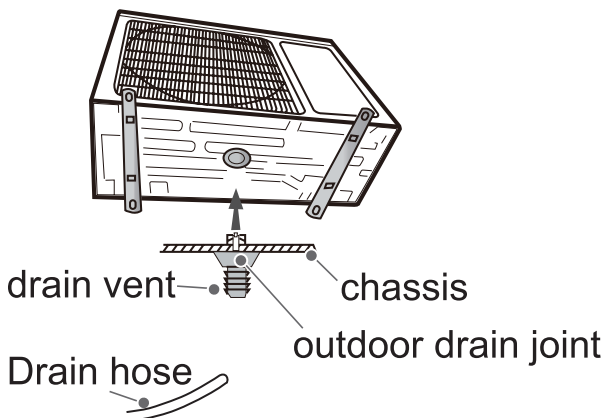

Step three: fix outdoor unit

1. Place the outdoor unit on the support.
2. Fix the foot holes of outdoor unit with bolts.

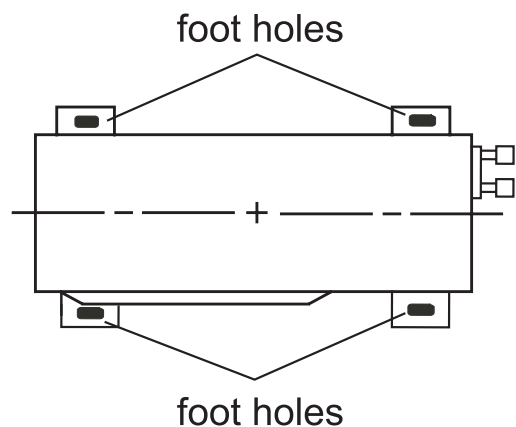

Installation of outdoor unit

Step four: connect indoor and outdoor pipes

1. Remove the screw on the right handle of outdoor unit and then remove the handle.

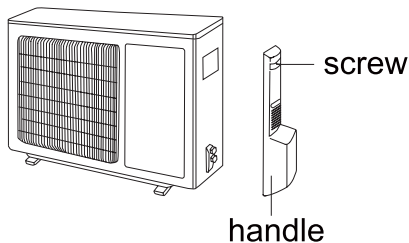

2. Remove the screw cap of valve and aim the pipe joint at the bellmouth of pipe.

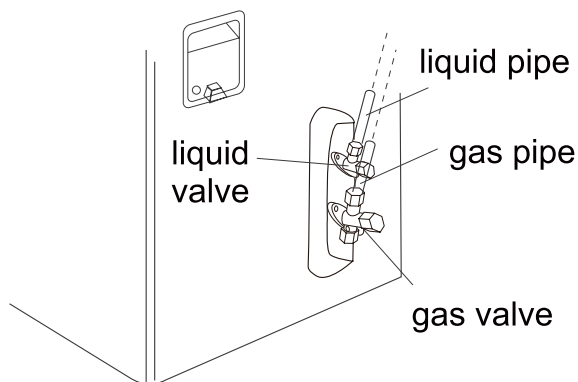

3. Pretightening the union nut with hand.

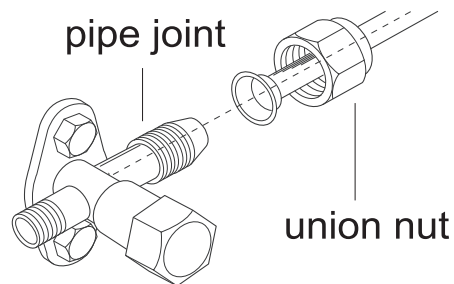

4. Tighten the union nut with torque wrench by referring to the sheet below

Hex nut diameter	Tightening torque (N.m)
16.4 cm (6.35)	15~20 (N.m)
24.2 cm (9.53)	30~40 (N.m)
32.2 cm (12.70)	45~55 (N.m)
40.3 cm (15.88)	60~65 (N.m)
49.5 cm (19.05)	70~75 (N.m)

Step five: connect outdoor electric wire

1. Remove the wire clip; connect the power connection wire and signal control wire (only for cooling and heating unit) to the wiring terminal according to the color; fix them with screws.

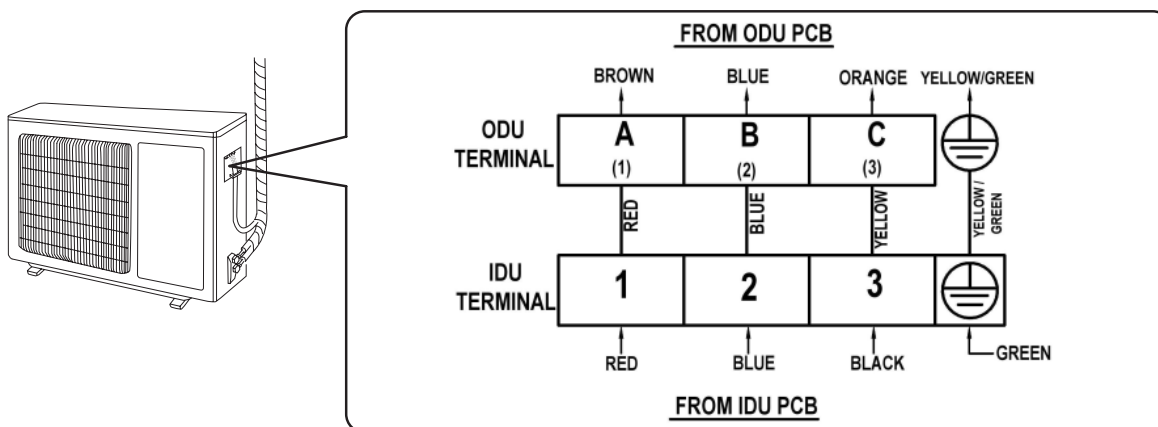

NOTE:

- Please refer to the actual wiring diagram on the unit.

Installation of outdoor unit

- Fix the power connection wire and signal control wire with wire clip (only for cooling and heating unit).

Note:

- After tighten the screw, pull the power cord slightly to check if it is firm.
- Never cut the power connection wire to prolong or shorten the distance.

Step six: neaten the pipes

- The pipes should be placed along the wall, bent reasonably and hidden possibly. Min. semidiameter of bending the pipe is 10 cm.
- If the outdoor unit is higher than the wall hole, you must set a U-shaped curve in the pipe before pipe goes into the room, in order to prevent rain from getting into the room.

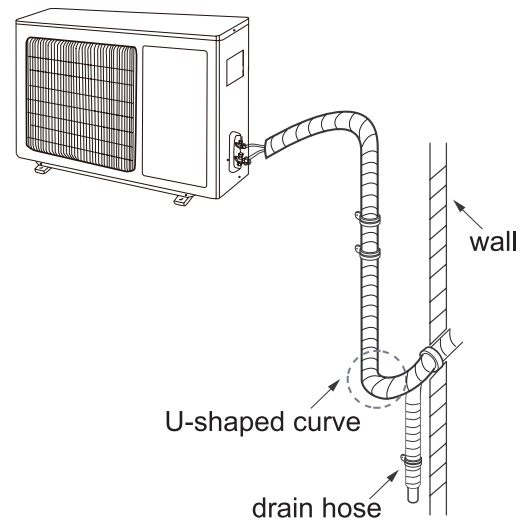

Note:

- The through-wall height of drain hose shouldn't be higher than the outlet pipe hole of indoor unit.
- Slant the drain hose slightly downwards. The drain hose can't be curved, raised and fluctuant, etc.

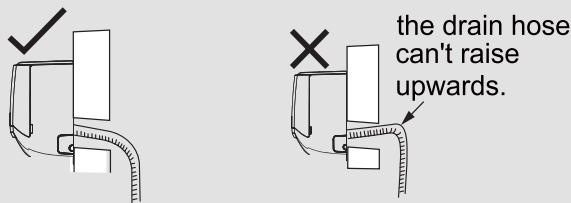

- The water outlet can't be placed in water in order to drain smoothly.

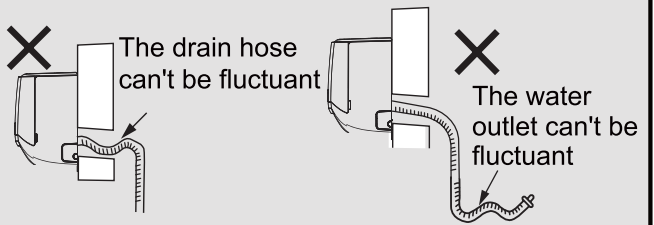
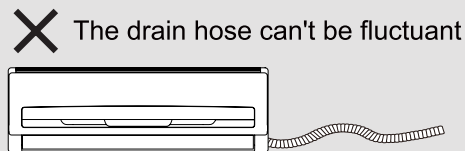
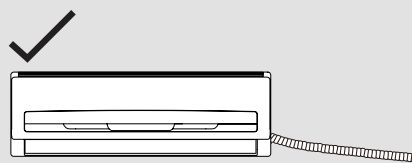
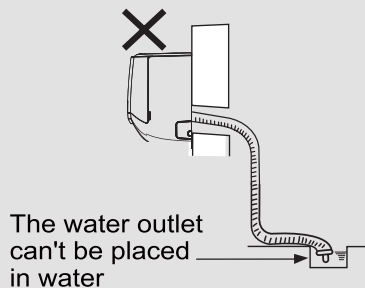

Vacuuming

Use vacuum pump

1. Remove the valve caps on the liquid valve and gas valve and the nut of refrigerant charging vent.
2. Connect the charging hose of piezometer to the refrigerant charging vent of gas valve and then connect the other charging hose to the vacuum pump.
3. Open the piezometer completely and operate for 30 min to check if the pressure of piezometer remains in -0.1 MPa.
4. Close the vacuum pump and maintain this status for 1-2 min to check if the pressure of piezometer remains in -0.1 MPa. If the pressure decreases, there may be leakage.
5. Remove the piezometer, open the valve core of liquid valve and gas valve completely with inner hexagon spanner.
6. Tighten the screw caps of valves and refrigerant charging vent.
7. Reinstall the handle.

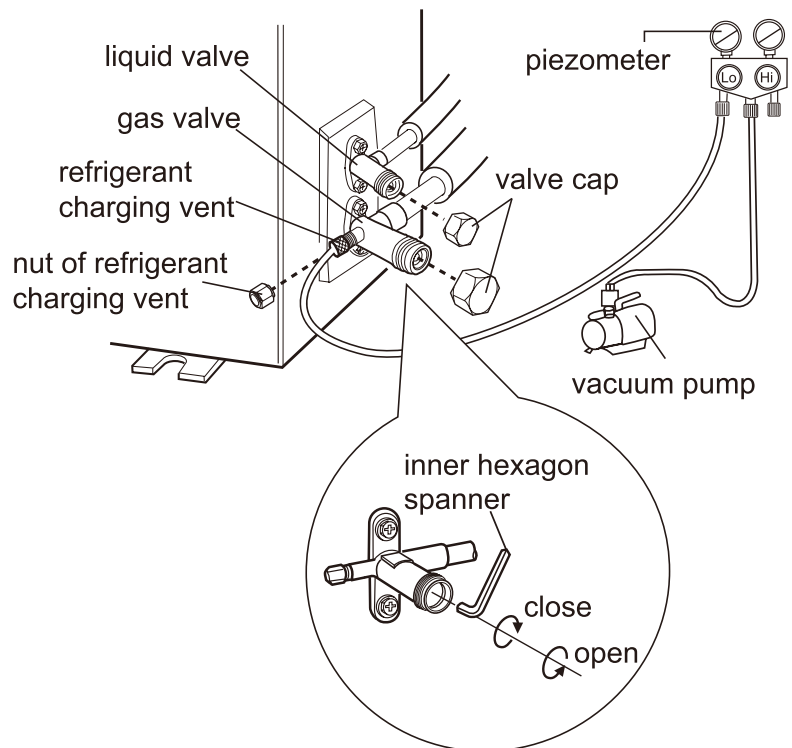

Leakage detection

1. With leakage detector:
Check if there is leakage with leakage detector.
2. With soap water:
If leakage detector is not available, please use soap water for leakage detection. Apply soap water at the suspected position and keep the soap water for more than 3 min. If there are air bubbles coming out of this position, there's a leakage.

Check after installation

- Check according to the following requirement after finishing installation.

Items to be checked	Possible malfunction
Has the unit been installed firmly?	The unit may drop, shake or emit noise.
Have you done the refrigerant leakage test?	It may cause insufficient cooling (heating) capacity.
Is heat insulation of pipeline sufficient?	It may cause condensation and water dripping.
Is water drained well?	It may cause condensation and water dripping.
Is the voltage of power supply according to the voltage marked on the nameplate?	It may cause malfunction or damaging the parts.
Is electric wiring and pipeline installed correctly?	It may cause malfunction or damaging the parts.
Is the unit grounded securely?	It may cause electric leakage.
Does the power cord follow the specification?	It may cause malfunction or damaging the parts.
Is there any obstruction in the air inlet and outlet?	It may cause insufficient cooling (heating) capacity.
The dust and sundries caused during installation are removed?	It may cause malfunction or damaging the parts.
The gas valve and liquid valve of connection pipe are open completely?	It may cause insufficient cooling (heating) capacity.
Is the inlet and outlet of piping hole been covered?	It may cause insufficient cooling (heating) capacity or waste electricity.



Note: *After installation, kindly run intelligent diagnostic mode.

Test operation

Preparation of test operation

- The client approves the air conditioner.
- Specify the important notes for air conditioner to the client.

Configuration of connection pipe

Standard length of connecting pipe:

- 12 K (1.0 Tr) is 2.9 m[#] | 3.0 m[#]
- 18 K (1.5 Tr) is 2.9 m[#] | 3.0 m[#]
- 24 K (2.0 Tr) is 3.0 m[#] | 3.5 m[#]

[#]Length may vary from model to model

*Connecting kit availability may vary model to model.

Max. length of connection pipe and max elevation as per below table

Model	Total Length	Max Elevation (vertical height)
All models – 12K/18K/24K	15 metre	5 metre

Diameter of connection pipe		Outdoor unit	
Liquid pipe	Gas pipe	Cooling (g/m)	Heat Cool (g/m)
6.35 mm	9.52 mm	15 (g/m)	20 (g/m)
6.35 mm	12.7 mm	20 (g/m)	30 (g/m)
6.35 mm	15.87 mm	30 (g/m)	50 (g/m)

! **CAUTION:** DO NOT MIX REFRIGERANT TYPES.

Pipe expanding method

Note:

Improper pipe expanding is the main cause of refrigerant leakage. Please expand the pipe according to the following steps:

A: Cut the pipe

- Confirm the pipe length according to the distance of indoor unit and outdoor unit.
- Cut the required pipe with pipe cutter.

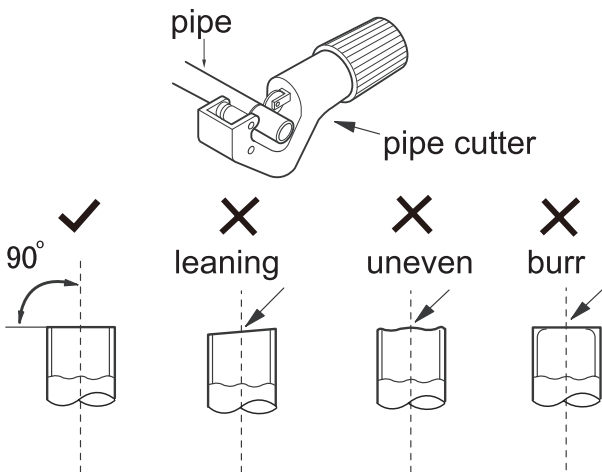

B: Remove the burrs

- Remove the burrs with shaper and prevent the burrs from getting into the pipe.

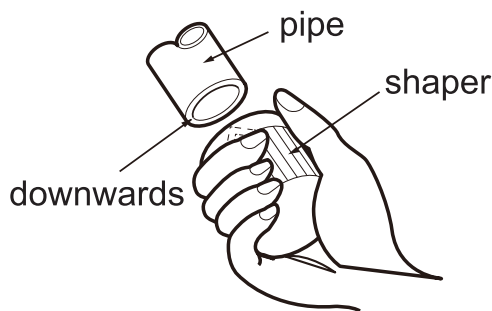

C: Put on suitable insulating pipe

D: Put on the union nut

- Remove the union nut on the indoor connection pipe and outdoor valve; install the union nut on the pipe.

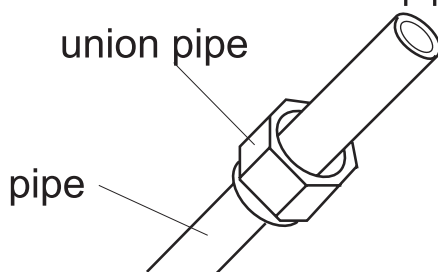

E: Expand the port

- Expand the port with expander.

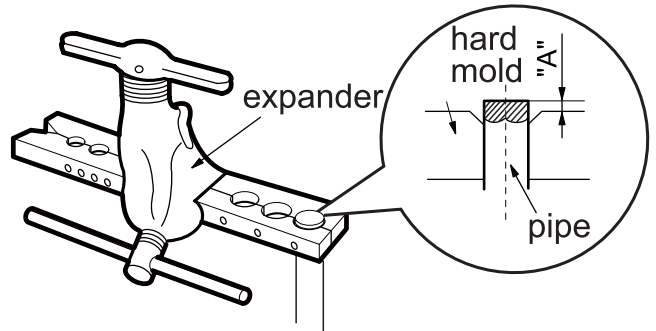

Note:

- "A" is different according to the diameter, please refer to the sheet below:

Outer diameter (mm)	A (mm)	
	Max	Min
Φ 6-6.35(1/4)	1.3	0.7
Φ 9.52(3/8)	1.6	1.0
Φ 12-12.7(1/2)	1.8	1.0
Φ 15.8-16(5/8)	2.4	2.2

F: Inspection

- Check the quality of expanding port. If there is any blemish, expand the port again according to the steps above.

smooth surface

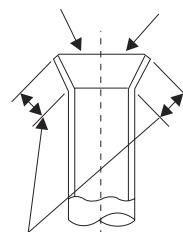

improper expanding

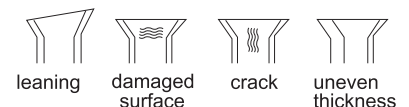

the length is equal

Compressor Frequency Setting Instruction

TEST MODE

When MODE+TURBO keys are pressed for 5 s then, “rE” will appear on temperature window for 2 s then “16” will start blink. with the help of UP/DOWN key user can set test code in range of 16-19. Following are the significance of test code.:

16-FULL LOAD TEST

17-HALF LOAD TEST

18-MINIMUM RPS LOAD

19-MAXIMUM RPS LOAD

From POWER key we can send TEST Code to IDU. we get Exit from the mode by pressing MODE+TURBO key or by removing batteries from handset. Following keys will work :- mode-power key, UP key & DOWN key.

Note: The above setting is for performance testing purpose only.
This setting can be used inside the Lab.

*applicable only for inverter models

WARRANTY TERMS AND CONDITIONS



WARRANTY PERIOD:

M/s. Havells India Ltd. ("Company") hereby offers a limited warranty ("Warranty") for its Lloyd branded Air Conditioner ("Product") against manufacturing defect/s for a period of one year from the date of invoice, on the terms and conditions provided hereinafter.

The company hereby also offers a limited warranty for compressor of the product against manufacturing defects for a period of 60 months for Fixed speed models and 120 months for Inverter models, warranty will commence from the date of invoice.

WARRANTY TERMS AND CONDITIONS:

To claim Warranty, the original invoice and wherever possible original Warranty certificate (duly signed and stamped by the selling dealer) must be presented by the customer.

To avail Warranty services, the customer can log in his complaint with the customer care cell.

This Warranty is valid only in respect of the Product purchased in India.

This Warranty is limited to the first purchaser of the Product only.

This Warranty cannot be clubbed with any promotional Warranty scheme prevalent on the date of the invoice unless specifically provided for in any special Warranty schemes.

To avail any Extended/Additional Warranty provided by the Company, customer should comply with the Product registration and other Terms and Conditions of the Extended/Additional Warranty as available on the website- www.mylloyd.com.

The Warranty period specified above shall include the period when the Product is not in use, time taken for repairs, replacements, breakdowns, transit time, etc. No notice of expiry period of Warranty will be given by the Company.

It is clarified that after one year from the date of invoice, Company's responsibility to continue to provide additional Warranty services in terms as agreed upon shall however be limited only to supply of the parts free of cost and any cost(s) incurred towards labor, transportation, refilling of refrigerant, and any other incidental expenditure for providing the said Warranty services shall be borne by the customer.

The decision to repair or replace any part of the Product shall be at the sole discretion of the Company. In case of repair or replacement of any part of the Product during the said Warranty period, the Warranty of the repaired or replaced part shall thereafter continue only for the unexpired period of Warranty.

If the Product is not repairable at the place of installation then the decision of Company's Authorized Service Representative to take the Product to the service center for repair shall be final. Company's decisions on all questions and complaints regarding the defects, shall be conclusive.

The defective spare parts shall be sole property of the Company or its Authorized Service Partner during the Warranty period.

In the event of any unforeseen circumstance, and/or spares are not available, Company's prevailing depreciation rules will be binding on the customer to accept as a commercial solution in lieu of repairs. The depreciation rule will be applicable after one year from the date of purchase.

If repair or replacement of component/part is rendered illegal because of subsequent law changes, the Company will have no responsibility for procuring replacement of parts if doing so would be commercially impractical.

To avail Warranty services for the Product, any recommendations made by the Company's visiting Authorized Service Representative shall be complied by the customer and if that recommendation requires repair of any electrical installations, wiring or of any third party product attached to the Product, it shall be first undertaken by the customer at his entire cost. Thereafter, the Warranty for the Product can be availed.

Company shall not be held liable or be deemed to be in default for any delay or failure in performance resulting directly or indirectly from causes beyond its control including delay in repairing due to non-availability of any component or accessory, labor problem, restrictions and regulations of the government, public movement, war and any other unavoidable/unforeseen circumstances including any force majeure event, specially vis-à-vis the import of supplies and raw material.



In case of any request to change the location where the Product has been initially installed during the Warranty, the customer will log in a request with customer care cell to ensure that the dismantling / inspection of the Product is done by a Company's Authorized Service Representative at the existing location. Thereafter the customer shall transport the Product to the new location at his own cost and consequences for re-installation of the Product. The customer shall again log in a request with the customer care cell for such re-installation which shall be undertaken by Company's Authorized Service Representative. Such dismantling and re-installation, undertaken during the Warranty period shall be done on chargeable basis. Any damage to the Product caused on account of such transit shall be at customer's cost and risk and Company shall not be held responsible in any manner whatsoever.

Customer shall ensure that a stabilizer is installed in those areas where voltage is not as per Product specification.

The Warranty provided herein is in lieu of implied conditions and warranties under the law and is confined to the repair or replacement of defective parts and does not cover any economic loss, commercial loss, consequential or resulting liability, damage to the property, or any other harm or loss.

None of the employees and /or Authorized Dealers of the Company have any authority whatsoever to vary the terms and conditions of this Warranty.

In the event that any terms and condition of this Warranty becomes invalid and/or unenforceable, the remaining terms and provisions shall continue in full force and effect.

Exclusions to Warranty:

- If the Product is serviced, repaired, installed, de-installed, re-installed or otherwise attended to by any person other than the Authorized Service Representative of the Company.
- If customer violates Warranty terms and conditions, instruction manual guidelines, recommendations of Authorised Service Representative and/or operates the Product otherwise than as per Product specifications.
- If the serial number affixed by the Company on the Product or any part thereof is damaged, defaced, obliterated or erased/ tampered with for any reason whatsoever or if Product is refurbished/modified.
- If the Product is operated in conditions otherwise than normal conditions (e.g., abnormal voltage surge, extreme heat, corrosive/alkaline/acidic atmosphere, dust ,damage from sea water, pollution ,chemical environment ,sulfur in the air, installation near the open drainage system etc.)
- If the Product is moved from its original place of installation to a new location (i.e. reinstalled) by a person other than the Authorized Service Representative of the Company.
- Any harm caused due to accident, negligence, improper maintenance, mishandling, tampering, incurred in transit by the customer or which can be attributed to the fault of the customer.
- Any harm resulting from any unforeseeable circumstances such as force majeure event etc.;
- Any harm caused due to any defect in any electrical/civil installation(s), wiring or third party products.
- Any liability resulting from any un-authorized adaptations, attachments and/or adjustments to the Product or from a third party apparatus or equipment;
- Any loss of refrigerant caused due to sabotage, improper handling or treatment, carelessness, accident, fire, flood earthquake or any natural calamity, any corrosive action on the original refrigerant pipes, fittings and valves etc. for whatever reasons.
- Any damage to the Product due to household pets, rodent or any other insect/animals.
- Plastic parts, accessories and external parts of the Product;
- Normal wear & tear of parts, corrosion & rusting.

Havells India Ltd.
Warranty Registration Card
Customer Copy



Serial No.

Customer Details

Title: Mr Ms Mrs M/s

Name:

Residence Address:

Dist: Pin:

State: Occupation:

Tel: () Res: () Fax:

Code Code

Mobile No: Email:

Product Details

Model No:

Serial No

Please Refer Sticker On Back Cover Of Your Product

Purchase Date

Day Month Year

Bill No.

Dealer's Name & Address
Signature

I Accept The Terms And Conditions of The Warranty Customer Signature

Thank you for selecting a World Class product and we assure you that it will perform as per your expectations
 We thank you for taking your time to complete this form. All Information Provided by You will be Kept Confidential.
 (Please Fill In, Tear off, Fold and Mail this form to Reach us within 10 days of the Product Purchase.)

We welcome your Valuable Suggestions, if any, to Improve our Products and Services :

FOR OFFICE USE ONLY

Customer Code:

Branch:



Havells India Ltd.

Registered Office: 904, Surya Kiran Building, K.G. Marg, New Delhi - 110001 (INDIA)

For Consumer Complaint, Contact: Consumer Care Executive **Havells India Ltd.**
QRG Towers, 2D, Sector - 126, Expressway, Noida - 201304, U.P. (INDIA)

Email: customercare@havells.com

Customer Care No.: 0804-577-5666