

Operating Instructions



STEALTH *Air* / **STEALTH** *WOOD*
Ceiling Fan

Ceiling Fan



PACKAGE CONTENTS

In the box check for following items :



Motor (1 N)



Canopy Set (1 N)



Downrod Cover (1 N)



Blade set (1 N)
containing Blades (3 N)



Shackle Kit
(1 N)



Downrod
(1 N)



Twisted Wire
(1 N)

Blade Installation (Figure. 1)

- 1) Unscrew the blade screw from motor and align the blade slot with the motor.
- 2) Screw the blade to the motor and ensure the tight fit.
- 3) Ensure blades must have same numerical code for precise balancing of fan.

IMP: While tightening the blade screws on motor, ensure that blade profile is not damaged.

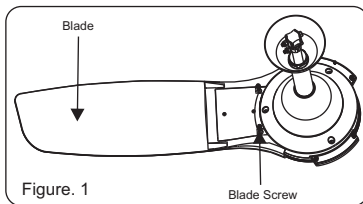

FAN INSTALLATION :

1. For installation of Fan with downrod, the following instructions and methods are to be followed. Remove the downrod cap from downrod and slide the bottom canopy over the downrod and then slide top canopy from top side.
2. Pass the Power supply & earthing wires (to be installed by customer at their end) through the downrod from top side holes and pull the wires from slit hole of the downrod.
3. Remove the split pin, hex nut, lock nut, spring washer, aluminium spacers from the bolt assembly supplied with the shackle assembly (Figure 2). Remove the safety/earthing screw on the shaft and keep it securely
4. Slide the downrod (from split end side) over the shaft. Align the cross holes on the downrod and the shaft.
5. Now use one Aluminium spacer on each side of the down rod for gripping and insert the bolt, place the spring washer and tighten the hex nut and the lock nut and tighten them fully, holding the bolt head with a spanner.
6. Ensure that this bolt is fully tighten. Insert the split pin and separate the projected ends.
7. Fix the earthing wire to safety/earthing screw and tighten the safety screw to shaft over down rod which was removed previously.
8. The shackle assembly provided has hex bolt with hex nuts, lock nuts and split pins. When hanging the fan on the hanger the hex bolts should be securely tightened with hex nuts & lock nut.
9. The split pins should be securely replaced in their place as shown in, assembled and exploded views (Figure 2 & Figure 3)

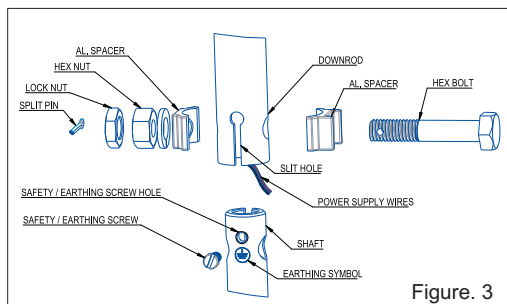

Figure. 3

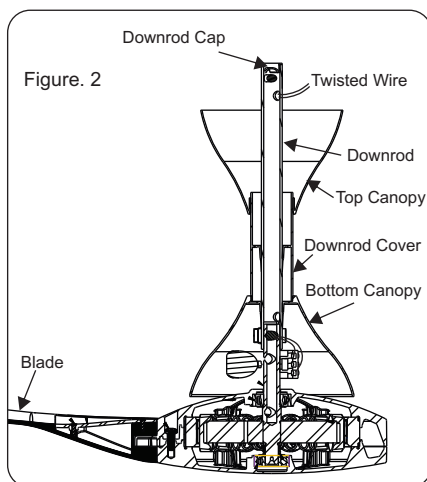
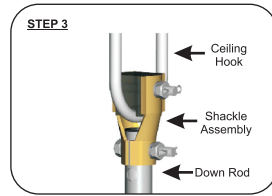
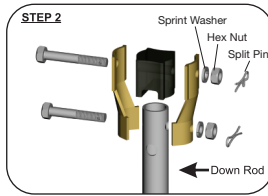
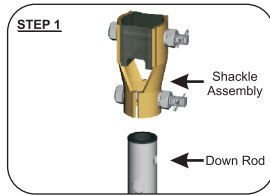

Figure. 2

Caution: Damage to Downrod & Bolt, due to loose fitting will not be covered under warranty.

Installation of fan with ceiling hook.

1. Follow below steps to mount fan on ceiling hook as shown in Step 1, Step 2 & Step 3.



INSTALLATION GUIDELINE FOR BETTER PERFORMANCE-

- To optimize the Air delivery, ceiling fan should be approx. 3.0 m from the ground level and 30.5 cm below the ceiling.
- Keep Minimum (80cm~1.2m) distance b/w blade tip and side walls.

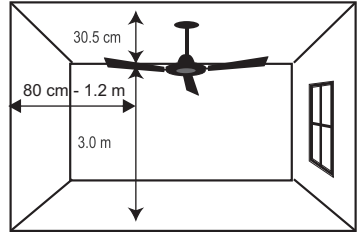

SELECTION GUIDE:

- Ceiling Fans recommended sweep for different room sizes-

| Model Size | Sweep / size (mm) | Suitable for room size |
|-------------|-------------------|-----------------------------------|
| Ceiling Fan | 600 mm | For Small Shops, Cabins & Toilets |
| Ceiling Fan | 750 mm | 1.8 m x 3.0 m |
| Ceiling Fan | 900 mm | 2.1 m x 3.0 m |
| Ceiling Fan | 1050 mm | 3.0 m x 3.0 m |
| Ceiling Fan | 1200 mm | 3.6 m x 3.9 m |
| Ceiling Fan | 1400 mm | 4.2 m x 4.8 m |

Troubleshooting –

| Problem | Solution |
|-----------------------|--|
| A. Fan does not start | <ol style="list-style-type: none"> 1. Check circuit fuses or breakers. 2. Check line wire connections to the fan and switch wire connections in the switch housing <p>CAUTION: Make sure main power is OFF</p> |
| B. Fan sounds noisy | <ol style="list-style-type: none"> 1. Make sure all motor housing screws are snug. 2. Make sure the screws that attach the fan blade to the motor hub is tight. 3. Make sure there is a gap between Top canopy and Ceiling. |
| C. Fan wobbles. | <ol style="list-style-type: none"> 1. Check that all blade screws are tight. 2. Ensure all blades are of same numerical code. |

Warning: to reduce the risk of personal injury:

1. Do not damage the blade while installing or cleaning the fan.
2. Do not insert foreign objects between rotating fan blades.

CAUTION:

1. Do not damage the blade arm while installing or cleaning the fan.
2. Do not insert foreign objects between rotating fan blades.
3. Tighten the Safety screw and Down-rod Bolt properly and lock with lock nut & split pin.
4. Tighten the Ceiling Plate separately with screw in Ceiling.

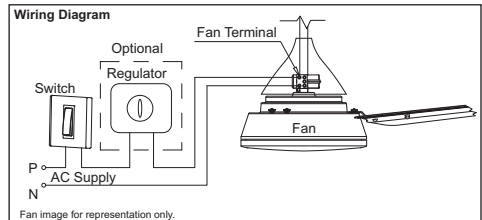

E-WASTE DISPOSAL

Environmental Compliances:

As per the rules laid down by the Government for environmental concern & safety, your product has been made to comply and conform to the respective regulation as listed below. This product falls under the E-WASTE (MANAGEMENT) RULES, 2022 with all amendments of Ministry of Environment, Forest & Climate Change.

RoHS Declaration:

This Product is in conformity with requirements of Rule 16 of the E-WASTE (MANAGEMENT) RULES, 2022 with all amendments. The content of hazardous substances with the exemption of the applications listed in SCHEDULE II of the E-Waste (Management) Rules, 2022 with all amendments is as follows:

- Lead (Pb): not over 0.1% by weight;
- Mercury (Hg): not over 0.1% by weight;
- Cadmium (Cd): not over 0.01% by weight;
- Hexavalent Chromium (Cr⁶⁺): not over 0.1% by weight;
- Polybrominated Biphenyls (PBBs): not over 0.1% by weight;
- Polybrominated Diphenyl Ethers (PBDEs): not over 0.1% by weight.

Do's and Don'ts for disposal of product:



1. Do's:

- Always drop your used electrical/electronic products, defective spares or any accessories and packaging materials after the end of their life at the nearest authorised collection point/center.
- Make sure that your electronic products are recycled only by authorised recyclers/dismantlers.
- Segregate the packaging materials according to their respective waste disposal options and sorting for recycling.
- Protect the glass surface of any electronic product to avoid breakage.

2. Don'ts:

- Never dismantle your electronic product yourself.
- Never sell or give E-Waste to informal and unorganised sectors like local scrap dealer/rag pickers.
- Never dump E-Waste in garbage bins or municipal solid waste stream.
- Do not dispose your product as unsorted municipal waste.

For more information on safe disposal, recycling and collection point, visit our website <https://www.myloйд.com/about-us/social-initiatives> and <https://www.havells.com/en/discover-havells/ewaste-awareness.html> or write a mail to ewaste@havells.com

Copyright Subsists. Imitation of trade dress, graphics and color scheme of this document is a punishable offence.

Due to continuous product improvement, the product illustrated on this carton may vary slightly from the actual product.

Diagrams/figures appearing in this document are for illustration purposes only.

Havells India Ltd.

Corp Office: QRG Towers, 2D, Sector-126, Expressway, Noida-201304 (U.P) Ph. +91-120-4771000

Email : marketing@havells.com, www.havells.com

For Consumer Complaint, Contact: Manager, Havells India Ltd.

QRG Towers, 2D, Sector-126, Expressway, Noida-201304

Customer Care No. 08045 77 1313

customercare@havells.com



HAVELLS