

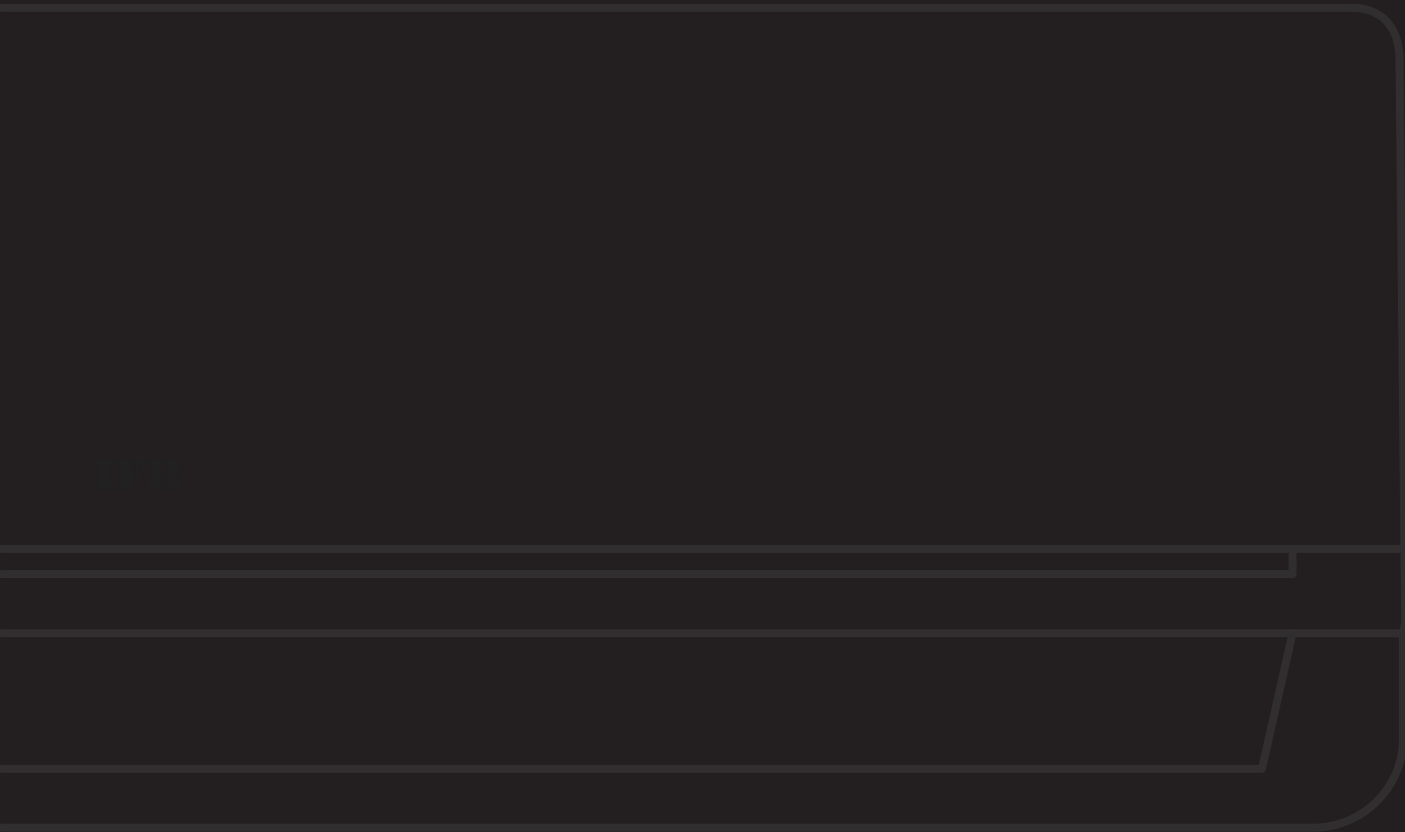

FASTCOOL

THE HEAVY DUTY AIR CONDITIONER



Read instructions before switching on the air conditioner.
Observe safety guidelines for installation.



CONTENTS

| | |
|------------------------------------|----|
| Safety guidelines for installation | 02 |
| Safety guidelines for user | 03 |
| Safety rules and prohibitions | 05 |
| The A to Z of your air conditioner | 06 |
| Auto Restart & Emergency Function | 09 |

Chapter 1: Getting started with your machine

| | |
|---|----|
| Installing your machine & safety guidelines | 15 |
| Modes of operation | 17 |

Chapter 2: Installing your air conditioner

| | |
|-------------------------------|----|
| Selecting the location | 21 |
| Key information for installer | 29 |

Chapter 3: Maintenance and cleaning

| | |
|--------------------------|----|
| Filter Clean Indicator | 31 |
| Replacing the batteries | 31 |
| Cleaning the air filters | 31 |
| Cleaning the Aesthetics | 31 |

Chapter 4: Useful information

| | |
|---------------------|----|
| Troubleshooting | 32 |
| Installation report | 33 |
| Warranty | 37 |

Warning Electrical safety of this appliance can only be guaranteed when continuity is complete between it and an effective earthing system which complies with local and national safety regulations. It is important that this basic requirement is present and regularly tested. When there is any doubt, the onsite wiring system should be inspected by a qualified electrician. IFB cannot be held liable for the consequences of an inadequate earthing system (eg electric shock etc).

Precautions:

This appliance conforms to safety requirements. Inappropriate use can lead to injury or damage to property. Please read this user manual carefully. It contains information on safety, installation, use and maintenance.

1. SAFETY GUIDELINES FOR INSTALLATION

- Read this guide before installing and using the appliance.
- During the installation of the indoor and outdoor units, access to the work area should be forbidden to children. Unforeseeable accidents could occur.
- Do not install and use a damaged machine. Before connecting the machine, ensure that the connection data on the data plate (fusing, voltage and frequency) match the main electricity supply. If any doubt, consult IFB Care.
- Make sure that the base of the outdoor unit is firmly fixed.
- Check that air does not enter the refrigerant system and check for refrigerant leaks when moving the air conditioner.
- Carry out a test cycle after installing the air conditioner and record the operating data.
- The user must protect the indoor unit with a fuse of suitable capacity for the maximum input current or with another overload protection device.
- Check that the socket is suitable for the plug; otherwise have a suitable socket installed.
- Do not install the air conditioner at a distance of less than 50cm from inflammable substances (alcohol etc) or from pressurized containers (eg. spray cans).
- If the air conditioner is used in areas without the possibility of ventilation, precautions must be taken to prevent any leakage of refrigerant gas from air conditioner in the environment and creating a danger of fire.
- The packaging materials are recyclable and should be disposed off in separate waste bins. Take the air conditioner at the end of its useful life to a special waste collection centre for disposal.
- Only use the air conditioner as instructed in this user manual. These instructions are not intended to cover every possible condition and situation. As with any electrical household appliance, common sense and caution are therefore always recommended for installation, operation and maintenance.
- Before accessing the terminals, all the power circuits must be disconnected from the power supply.
- The air conditioner must be installed in accordance with national wiring regulations.
- All air conditioner installation work must be carried out only by IFB authorized service personnel.
- Do not try to install the air conditioner alone; always contact IFB authorized service personnel.
- Cleaning and maintenance of the air conditioner must be carried out only by IFB authorized service personnel. The air conditioner must be disconnected from the electricity supply mains before carrying out any cleaning or maintenance.
- Do not switch OFF the air conditioner by pulling out the power plug when it is in

2. SAFETY GUIDELINES FOR USERS

operation, as this could create a spark and cause fire etc.

- This appliance has been made for air conditioning domestic environments and must not be used for any other purpose, such as for drying clothes, cooling food etc.
- Always use the appliance with the air filter mounted. The use of the air conditioner without the air filter can cause an excessive accumulation of dust or waste on the inner parts of the appliance with the possible risk of subsequent failure.
- The owner/user is responsible for having the appliance installed by IFB authorized service personnel who must check that it is earthed in accordance with current legislation and insert a thermo magnetic circuit breaker.
- The batteries of the remote control must be recycled or disposed of properly. Please discard the batteries as sorted municipal waste at the accessible collection point.
- Never remain directly exposed to the flow of cold air for all long time. The direct and prolonged exposure to cold air could be dangerous for your health. Particular care should be taken in rooms with children, elderly or sick people.
- If the air conditioner emits smoke or there is a smell of burning, immediately cut OFF the power supply and contact IFB care. Prolonged use of the device in such conditions can cause fire or electrocution.
- Unauthorized repairs could result in unforeseen dangers for the user, for which the manufacturer cannot accept responsibility. Only IFB authorized service personnel should undertake repairs.
- The airflow flaps must be directed downwards in the Heat Mode and upwards in the Cooling Mode.
- Ensure that the appliance is disconnected from the power supply when it will remain inoperative for a long period and before carrying out any cleaning or maintenance.
- Ensure that the air conditioner is connected to a 3-pin power socket with good earthing and MCB (as prescribed by the IFB authorized service technician) or other automatic short circuit protection device.
- To relocate and reinstall the air conditioner, Please contact IFB care.
- Do not bend, tug or compress the power cord since this could damage it. Electrical shocks or fire are most often caused by a damaged power cord. Only IFB authorized service personnel must replace a damaged power cord.
- Do not use extensions or gang modules.
- Do not touch the appliance when barefoot or when parts of your body are wet or damp.
- Do not obstruct the air inlet or outlet of the indoor or the outdoor unit. The obstruction of these openings causes a reduction in the operative efficiency of the air conditioner with possible consequent failures or damages.
- In no way alter the characteristics of the air conditioner.
- Do not install the air conditioner near

sources of heat or in an environment where the air contains gas, oil or Sulphur.

- Do not operate the air conditioner where inflammable substances such as oil, benzene or highly inflammable gas are present. Such materials may cause fire or explosions.
- This air conditioner can be used by children aged 8 years and above and persons with reduced physical, sensory or mental capabilities or lack of experience and knowledge if they have been given supervision or instructions concerning the use of the appliance in a safe way and understand the hazards involved.
- Do not leave windows or doors open for long when the air conditioner is operating.
- Do not direct the airflow onto plants or animals. Prolonged direct exposure to cold air can have negative effects on them.
- Do not bring the air conditioner in contact with water. The electrical insulation may be damaged, thus causing electrocution.
- Do not climb onto or place any objects on the indoor or outdoor units.
- Never insert any object inside the air conditioner. It can cause injury.
- Children should not play with the air conditioner. Cleaning and user maintenance should not be performed by children without supervision.
- The electrical safety of this appliance can only be guaranteed when continuity is complete between it and an effective earthing system, which complies with local and national regulations. It is most important that a qualified electrician

regularly tests this basic safety requirement. The manufacturer cannot be held responsible for the consequences of an inadequate earthing system.

- In case of high or Low Voltage, as specified on the rating plate, IFB suggest to use a Voltage Stabilizer for smooth operations of the air conditioner.
- In case the AC is operated on Solar panel/or DG a sine wave inverte Is recommended (To be verified by R&D).

3. SAFETY RULES AND PROHIBITIONS

About eWaste

eWaste or Electronic Waste or Waste Electrical and Electronic Equipment (WEEE) are the terms used to describe old, end-of-life or discarded appliances using electricity.

Dos and Don'ts for Customers

Dos

- Always dispose of products that have reached end-of-life by calling an authorized local eWaste recycler.
- Always drop off used electronic products, batteries or accessories at your nearest authorized eWaste recycler when they reach end-of-life.
- Whenever possible, or as instructed, sort packaging materials according to responsible waste disposal and recycling options.

Don'ts

- Do not dismantle electronic products on your own.
- Do not throw electronic products in bins with a 'Do Not Dispose' sign.
- Do not give eWaste to informal and unorganized sectors such as local scrap dealers and rag pickers.
- Do not dispose off your product in garbage bins along with municipal waste that ultimately reaches landfills.

Risks of Improper Handling of eWaste

eWaste usually includes components which, if disposed of improperly, hold environmental consequences such as air,

water and soil pollution and also pose product is disposed off correctly, you will help to prevent potential negative risks to human health. By ensuring this product is disposed off correctly, you will help to prevent potential negative consequences for the environment and human health. Components and materials used in the manufacture of this AC shall be disposed off responsibly.

This product is RoHS compliant

For detailed Information and Disposal Request

Contact IFB Care at 080 458 45678/ 080 695 45678 and provide your details to our representative to request your product to be picked up for disposal.

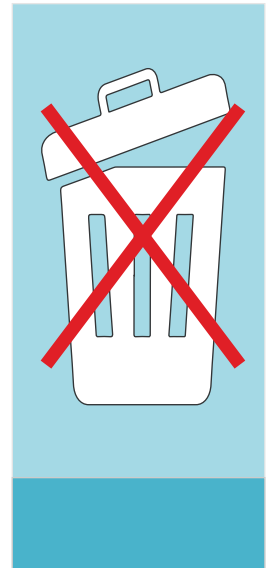

THE A TO Z OF YOUR AIR CONDITIONER

INDOOR UNIT

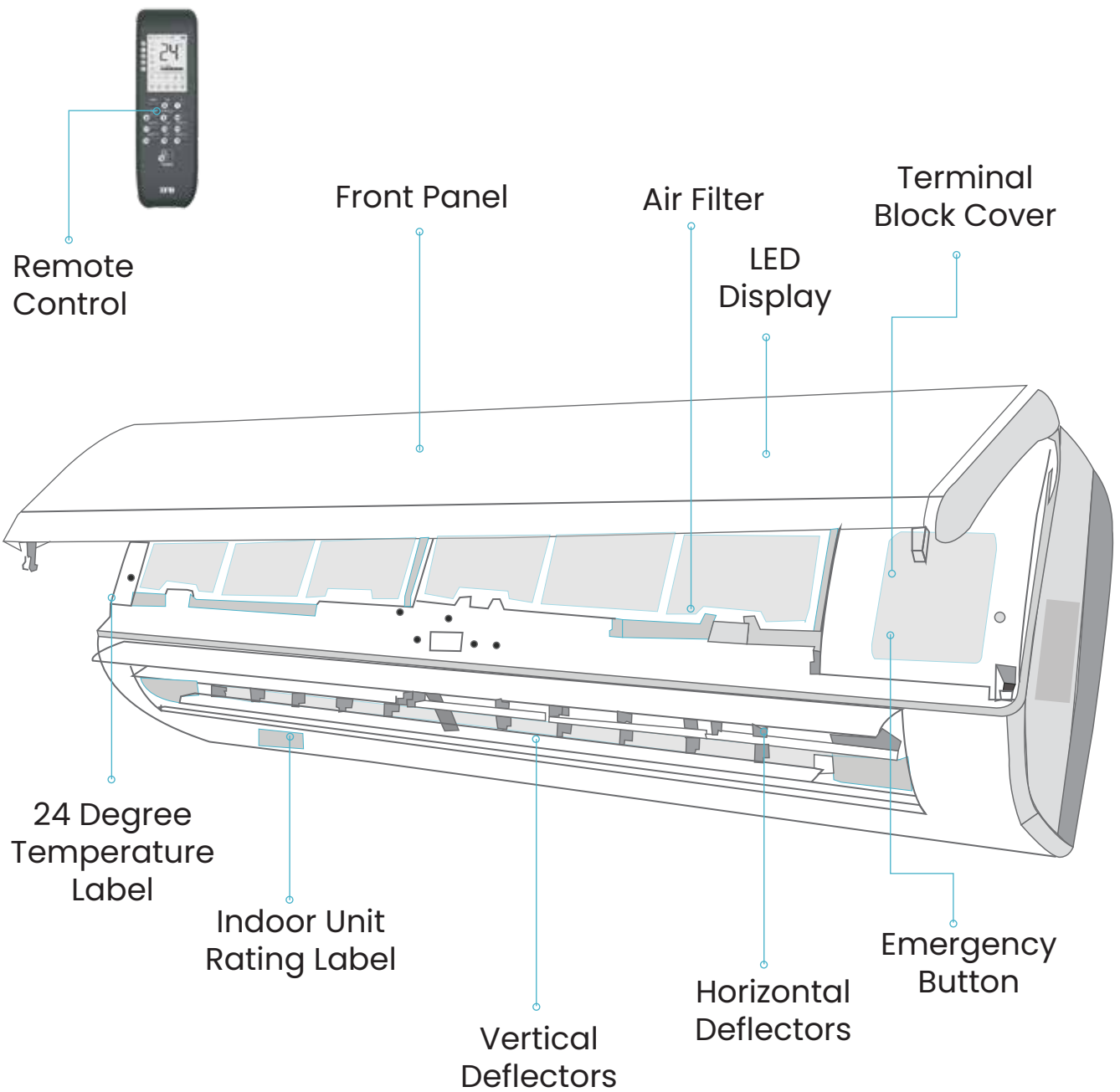

INDOOR UNIT DISPLAY

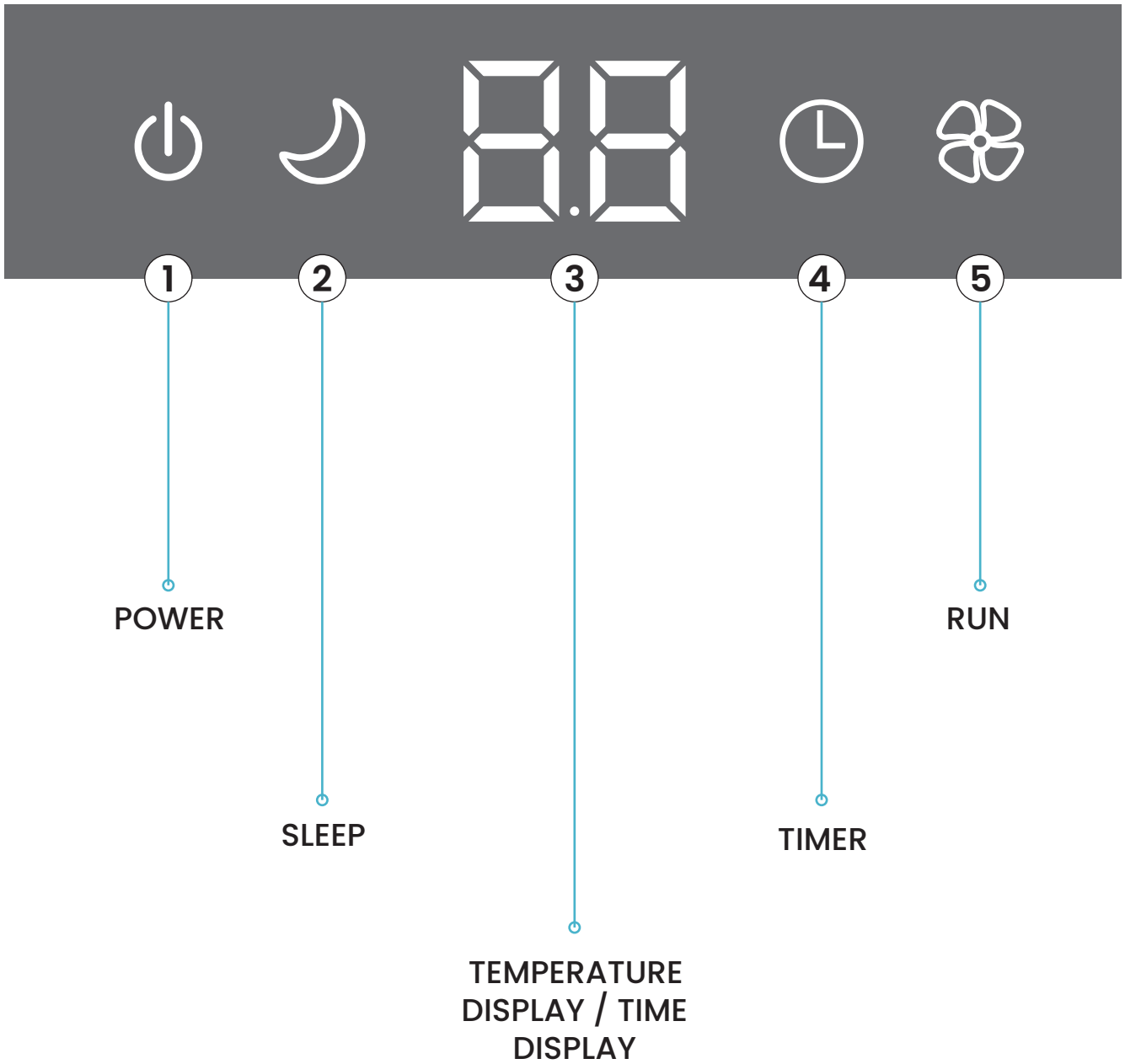

NOTE:

The shape and position of indicators may vary according to the model, and may not correspond to the appearance of the units that have been purchased but their function remain same.

THE A TO Z OF YOUR AIR CONDITIONER

OUTDOOR UNIT

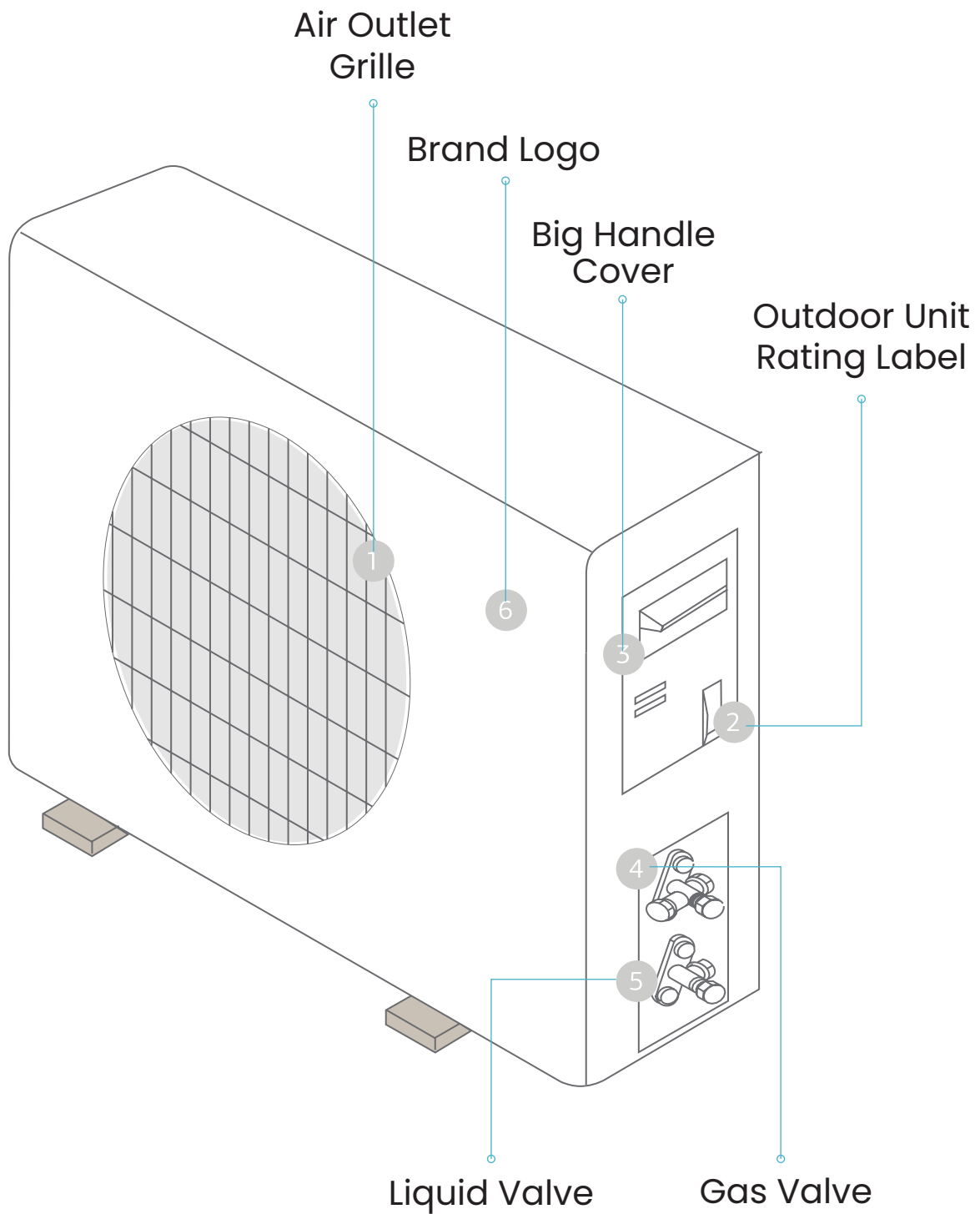

AUTO RESTART & EMERGENCY FUNCTION

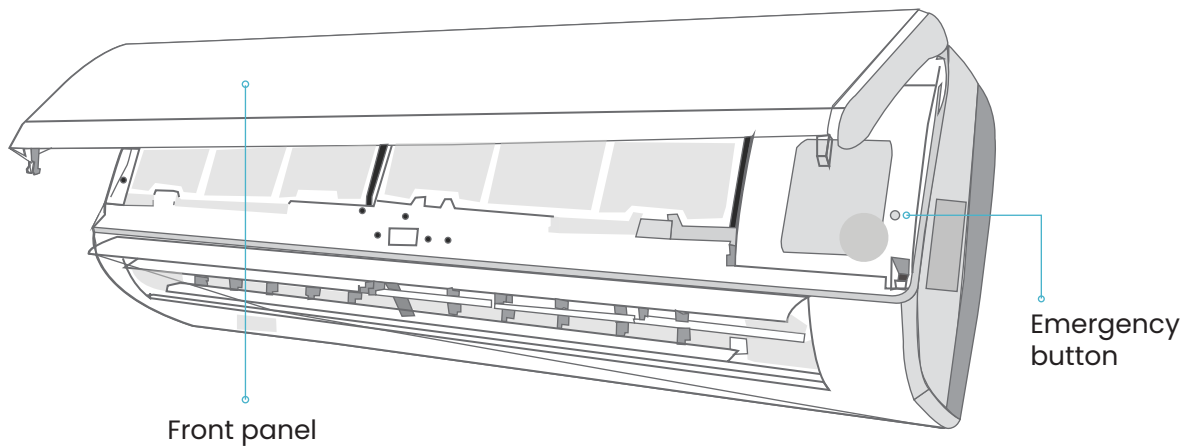

Auto Restart*

This function allows the air conditioner to keep the selected settings after a blackout or a voltage drop.

How to deactivate Auto Restart

- Switch the air conditioner OFF and unplug it from the power socket.
- Press the emergency button while re plugging the air conditioner into the wall socket.
- Keep the emergency button pressed for 10 seconds at least, until you hear four short beeps from the indoor unit.

How to activate Auto Restart

- Follow the same procedure for activation until you hear three short beeps from the indoor unit.

Emergency Function

In case you misplace the remote control for the indoor unit, proceed as follows

NOTE:

User can set clock time in 24 hrs format only.

- Lift the front panel of the indoor unit to reach the emergency button.
- If you press the button once (one beep), the air conditioner will work in Forced Cool Mode.
- To Switch off the Unit press the emergency key again.

Clock Setting for Remote Control























- To set the clock time, insert the batteries. Clock time will be initially shown as "00:00" and it will be blinking at the top left corner of the remote screen.
- Using + and - keys, user can set the right time. After setting the clock time, Press the power button, and the clock time will stop blinking.
- Later, If user want to change time, user can remove the batteries and repeat the same process.
- Each time you remove the batteries the remote will move between Cold Mode and Heat Mode. Select heat mode for Hot and Cold machine. In an event no mode is selected, Cold mode will be the default setting

REMOTE CONTROL



- 1 COOL MODE**
Allows to cool the room, also reducing the humidity in the air.
- 2 HEAT MODE**
Allows the air conditioner to produce hot air.
- 3 FAN MODE**
The air conditioner works using only the fan.
- 4 DRY MODE**
Reduces the humidity of the air to make the room more comfortable
- 5 AUTO MODE**
The air conditioner will automatically choose the temperature settings and fan speed
- 6 FAN**
Selects the fan speed - auto/low/mid/high
- 7 + TEMPERATURE UP**
Increases the temperature or time by 1 unit
- 8 TIMER ON/OFF**
Switches the air conditioner ON/OFF
- 9 SUPER--> ECO**
One press activates the Super Mode and Second press activates the Eco mode
- 10 - TEMPERATURE DOWN**
Decreases the temperature by 1 unit
- 11 HEALTH**
Press and hold 3 sec for ANTI MILDEW Switches ON/OFF the HEALTH function, controls the ANTI MILDEW Mode.
- 12 FLEXI**
Selects flexible cooling capacity steps 13
- 13 SWING**
Activates and deactivates swinging of horizontal and vertical deflectors
- 14 SLEEP**
Press and hold 3 sec for DISPLAY Activates the SLEEP function and Display
- 15 AMB**
Press and hold 3 sec for I-FEEL Displays Ambient temperature and activates I-FEEL function.
- 16 POWER**
Switches the air conditioner ON/OFF.

8. MEANINGS OF SYMBOLS

| | | |
|----|---|----------------------|
| 1 |  | AUTO/FEEL MODE |
| 2 |  | COOL MODE |
| 3 |  | DRY MODE |
| 4 |  | FAN MODE |
| 5 |  | HEAT MODE* |
| 6 |  | SIGNAL RECEPTION |
| 7 |  | TIMER ON |
| 8 |  | TIMER OFF |
| 9 | All 5 fans indicators gradually blink | AUTO FAN |
| 10 |  | LOW FAN SPEED |
| 11 |  | MIDDLE FAN SPEED |
| 12 |  | HIGH FAN SPEED |
| 13 |  | SLEEP MODE |
| 14 |  | FLAP SWING* ** |
| 15 |  | SUPER |
| 16 |  | ECO |
| 17 |  | AMBIENT TEMPERATURE* |
| 18 |  | HEALTH* |
| 19 |  | ANTI-MILDEW |
| 20 |  | BATTERY INDICATOR |
| 21 |  | CLOCK TIME |
| 22 |  | FLEXI STEPS* |
| 23 |  | DISPLAY FUNCTION |
| 24 |  | IFEEL* |



*This feature is only available in select remote controls/models.

**Vertical Swing (Left/Right swing) is available in select models only

NOTE:

The aesthetic and functions of the remote control may vary according to the model. The shape and position of the buttons and indicators may also vary but will have the same functions. The indoor unit confirms the reception of every input with a beep.

REMOTE CONTROL



• **Mode: Cool**

The Cool Mode allows the air conditioner to cool the room while also reducing the humidity in the air.

- To activate the Cool Mode press mode button until its symbol  appears on remote display.
- The cooling is activated by using the + and - buttons to set a temperature lower than that of the room.
- To optimize the functioning of the air conditioner, adjust the temperature, speed and direction of airflow by pressing buttons available on remote.
- As per national regulation, the default temperature of 24°C is set each AC is switched ON using remote.

NOTE: All rating values in the BEE label are measured at Super/Turbo speeds with the vertical deflectors in the straight position and the horizontal flaps in the open position.

• **Mode: Heat** (for hot and cold models only)

The Heat Mode allows the air conditioner to heat the room.

- To activate the Heat Mode press the mode button until its symbol  appears on remote display.
- The heating is activated by using the + and - buttons to set a temperature higher than that of the room.
- To optimize the functioning of the air conditioner, adjust the temperature, speed and direction of airflow by pressing buttons available on remote.
- The air conditioner is fitted with a Hot Start function that delays the starting of the air conditioner for a few seconds to avoid an immediate outflow of hot air.

NOTE:

In Heat Mode, the air conditioner can automatically activate a defrost cycle to remove any frost from the condenser. This usually lasts 2-10 minutes. During defrosting the fans stop turning. After defrosting is complete the air conditioner automatically returns to the Heat Mode.

• **Mode: FAN**

- In the Fan Mode the air conditioner works using only the fan.
- To activate the Fan Mode, press the mode button until its symbol  appears on remote display.
- Press the Fan button to change the fan speed as follows : Low, Medium, High
- The fan speed set will be stored in the memory

• **Mode: DRY**

- The Dry Mode reduces the humidity of the air to make the room more comfortable.
- To activate the Dry Mode , press the mode button until its symbol  appears on remote display.
- In this mode ,the fan works at a low speed by default and cannot be changed.

NOTE: In Dry Mode, the air conditioner sets automatically alternating cooling cycles and activates the fan. Actual room temperature and display temperature may differ during the operation.

• **Mode: AUTO/FEEL**

- In Auto Mode ,the air conditioner will automatically choose the temperature settings and fan speed.
- To activate the Auto Mode , press the mode button until its symbol  appears on remote display.
- In Auto Mode, the fan speed and temperature are set automatically according to the room temperature for optimal user comfort

NOTE: The temperature of the room will be determined by a probe integrated into the indoor unit.

• **Mode: ON TIMER**

- Before setting the Start time,choose the mode and fan speed while the air conditioner is ON
- Switch OFF the air conditioner

- Press the Timer button .Set Start Time by using + and - buttons. The time till the air conditioner switches ON should be displayed. Then press the Timer button again.
- To cancel the set Start Time, Press the Timer button again

NOTE: In case of a power outage, it is necessary to set the Start Time again.

• **Mode: OFF TIMER**

- To program the air conditioner to automatically switch OFF, Press the Timer button .Set the OFF Time by using the + and - buttons.The time till the air conditioner switches OFF should be displayed
- To cancel the set Stop Time, Press the TIMER button again

NOTE: In case of a power outage ,it is necessary to set the Stop Time again.

• **Mode: SUPER**

- If the Super button is pressed in Cool Mode ,the air conditioner will set to the lowest temperature of 16°C
- If the Super button is pressed in Heat Mode ,the air conditioner will set to the lowest temperature of 31°C

• **Mode: ECO**

- To activate the ECO mode, press the Super button twice and it's symbol  appears on remote display.
- In Cool Mode the temperature will gradually rise to 27°C and the compressor frequency will gradually decrease
- In Heat Mode ,the highest temperature will be 25°C. The air conditioner will keep the same temperature set is lower than 25°C

NOTE: Cooling is optimized in Eco Mode to save electricity

• **Mode: HEALTH**

- When Health key is pressed, this feature is activated, AC will start air purification function.
- When this feature is activated, AC will start its air purification function

NOTE: Applicable for selected models only.

• **Mode: ANTIMILDEW**

- To activate the ANTIMILDEW, press uni & hold Health key for 3 sec.
- The Anti Mildew Mode is used for drying the indoor cooling unit
- The indoor blower works for some time and indoor unit display will show '--' after AC is switched off to dry ,the unit will switcg off thereafter
- If power ON/OFF button is pressed during the operation the Antimildew will be cancelled.

• **Mode: FLEXI**

- This feature is used to select flexible capacity as per customer selection.
- When this key is pressed, C1, C2, C3, C4, C5 is displayed on remote and respective capacity is displayed on IDU as per below table.

| MODEL NAME | 1st press | 2nd press | 3rd press | 4th press | 5th press |
|----------------|-----------|-----------|-----------|-----------|-----------|
| | C1 | C2 | C3 | C4 | C5 |
| CI12/CI13/Hi13 | 0.9 | 0.8 | 0.7 | 0.6 | 0.5 |
| CI15 | 0.9 | 0.8 | 0.7 | 0.6 | 1.2 |
| | 1.0 | 0.9 | 0.8 | 0.7 | 0.6 |
| CI18/CI19/Hi18 | 1.3 | 1.2 | 1.0 | 0.8 | 0.6 |
| CI185 | 1.2 | 1.0 | 0.8 | 0.6 | 1.5 |
| CI120 | 1.2 | 1.0 | 0.8 | 0.6 | 1.7 |
| CI24/Hi24 | 1.7 | 1.5 | 1.2 | 1.0 | 0.8 |
| CI26 | 1.8 | 1.7 | 1.5 | 1.2 | 1.0 |
| CI28 | 2.0 | 1.8 | 1.5 | 1.2 | 1.0 |

NOTE: This feature is available in Cool Mode only.

• **Mode : SLEEP**

- The Sleep Mode automatically adjusts the temperature of the room to make it more comfortable
- To activate the Sleep Mode, press the Sleep button once.
- In the Cool, the set temperature will automatically rise by 1°C every 60 minutes, to achieve a rise of 2°C during the first hours of operation. In the Heat Mode, the set temperature will automatically decrease by 2°C during the first 2 hours operation.

NOTE: After 10 hours of operating in the Sleep Mode the air conditioner will automatically switch off.

• **Mode: DISPLAY**

- To activate Display function, press & hold Sleep key for 3 sec
- Display function allows a user to ON/OFF display of air conditioner unit.

• **Mode : AMBIENT**

- To check this Ambient Temperature press Amb key. Outdoor temperature will be displayed on Indoor unit display for 5 seconds.

NOTE: This feature is not available in Fan Mode.

• **Mode: I – FEEL**

- To activate the IFEEL Mode, press the Amb button for 3 sec and IFEEL symbol will be visible on the display.Thi
- When this feature is activated, AC start taking room temperature values from remote which have inbuilt temperature sensorThis

NOTE: This feature is available in Cool Mode only and is applicable in selected models only.

1. GETTING STARTED WITH YOUR MACHINE

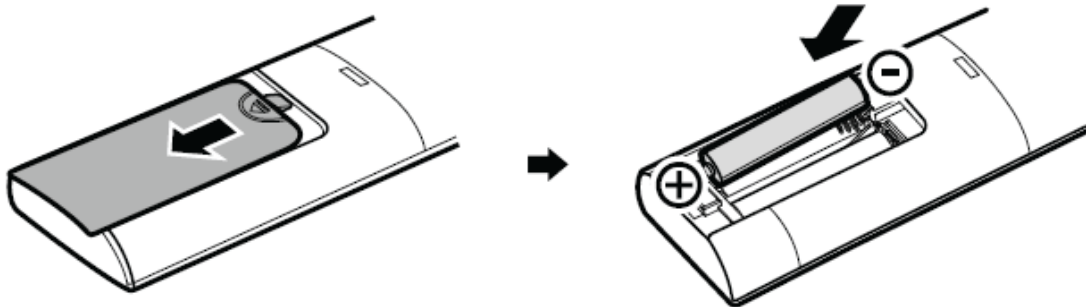

INSTALLING YOUR MACHINE & SAFETY GUIDELINES

Inserting batteries in the remote control

- Remove the cover of the remote control's battery compartment by sliding it in the direction of the arrow.
- Insert the new batteries, ensuring that the (+) and (-) directions are correct.
- Refit the cover by sliding it into place.

NOTE: Use two AAA (1.5 V) batteries. Do not use rechargeable batteries. Replace the batteries with new ones when the LED display is no longer legible.

The remote control's batteries must be disposed off in accordance with the applicable laws in force in the country of use.

When you insert the batteries for the first time in the remote control or if you change them, you need to program the remote control of only cooling or heat pump air conditioners. This is very easy. As soon as you insert the batteries, COOL and HEAT start flashing. If you push any button when COOL is displayed, the remote control is calibrated for the Cool Mode. If you push any button when HEAT is displayed, the remote control is calibrated for the Heat Mode.

NOTE:

After adjusting the function, you need to remove the batteries and repeat the procedure. If you calibrate the remote control for Cool Mode, it will not be possible to activate the heating function (in units with heating pumps). You will need to take out the batteries and repeat the procedure described above.

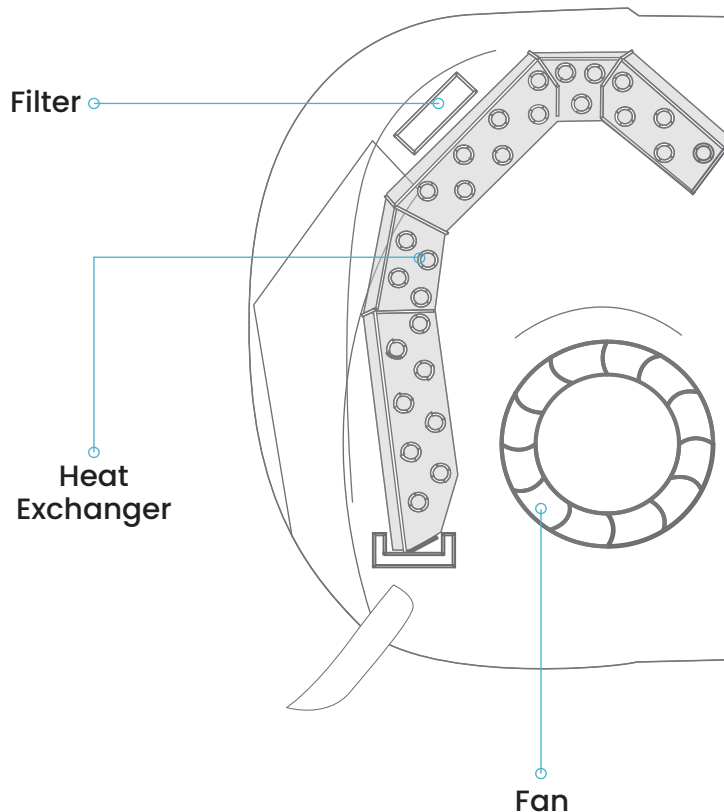

GUIDELINES FOR USING THE REMOTE CONTROL

- Direct the remote control towards the air conditioner.
- Check that there are no objects between the remote control and the infrared receiver of the air conditioner.
- Never leave the remote control exposed to direct sunlight.
- Keep the remote control at a distance of at least 1 m from televisions and other electrical appliances.

Modes of operation

The air conditioner is designed to create comfortable conditions by cooling and dehumidifying the air in the room. If required, it can also heat the air (in models with heat pump).

- The air drawn in by the fan enters through the grille of the front panel and passes through the air filter, which removes the dust.
- It is then conveyed to the heat exchanger and cooled and dehumidified (or heated). The heat removed from the room's air is emitted outdoors.
- The direction of the airflow is regulated by the deflectors, which are motorized up & down and right & left using the deflectors.

2. INSTALLING YOUR AIR CONDITIONER

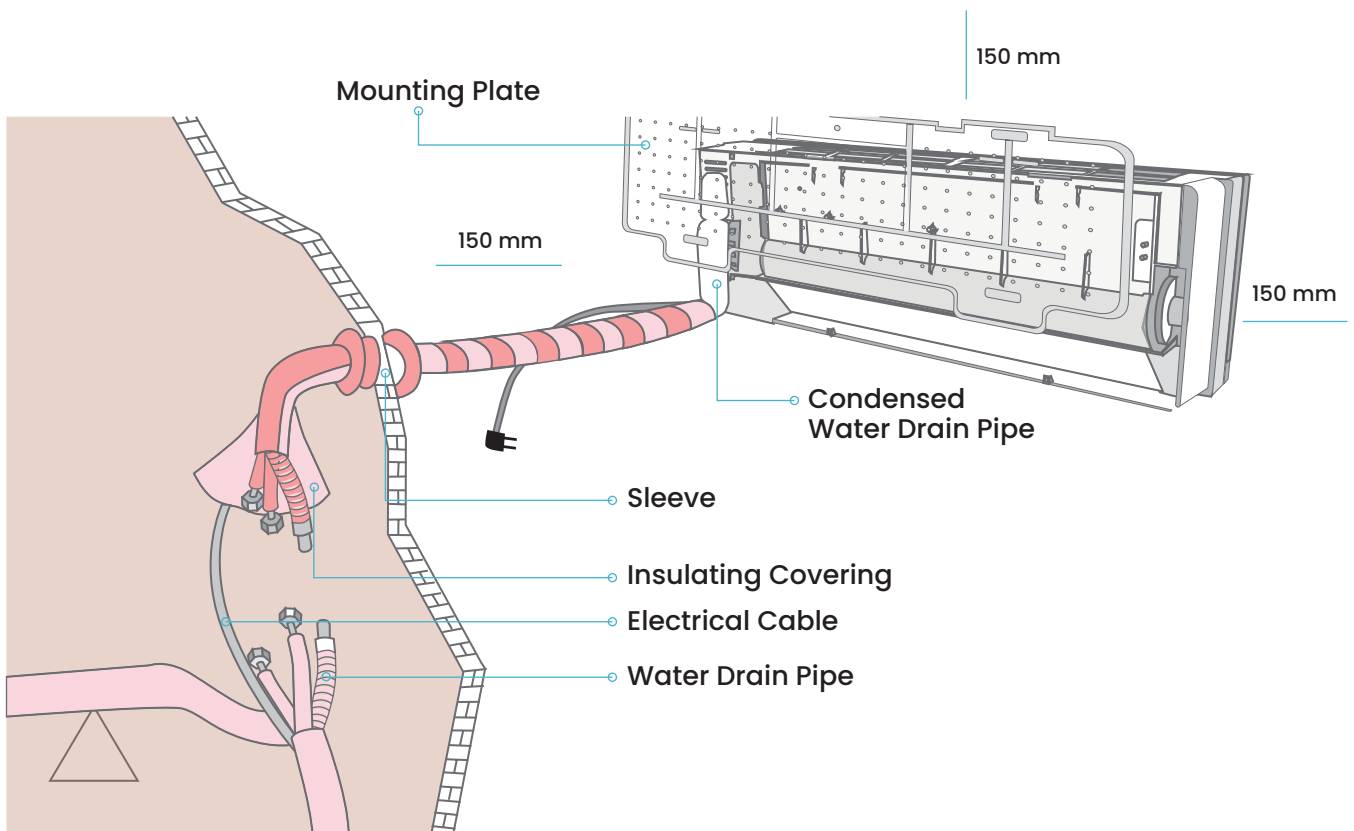

SELECTING THE LOCATION INDOOR UNIT

Before starting installation, decide on the position of the indoor and outdoor units, taking into account the minimum space required around the units. Install the indoor unit in the room to be air conditioned, avoiding corridors or communal areas.

- Install the indoor unit on a strong wall that is not subject to vibrations.
- The inlet and outlet ports should not be obstructed. The airflow should be able to reach every part of the room.
- Do not install the indoor unit near a

source of heat, steam or flammable gas.

- Install the indoor unit near an electric socket or private circuit.
- Do not install the indoor unit where it will be exposed to direct sunlight.
- Install the indoor unit so that it is easily connected to the outdoor unit.
- Install the indoor unit where it is easy to drain the condensed water.
- Check the air conditioner's operation regularly and leave the necessary spaces
- Install the indoor unit where the air filter can be easily accessed.

NOTE:

The indoor unit should be installed at a height of at least 2.5 m from the ground.

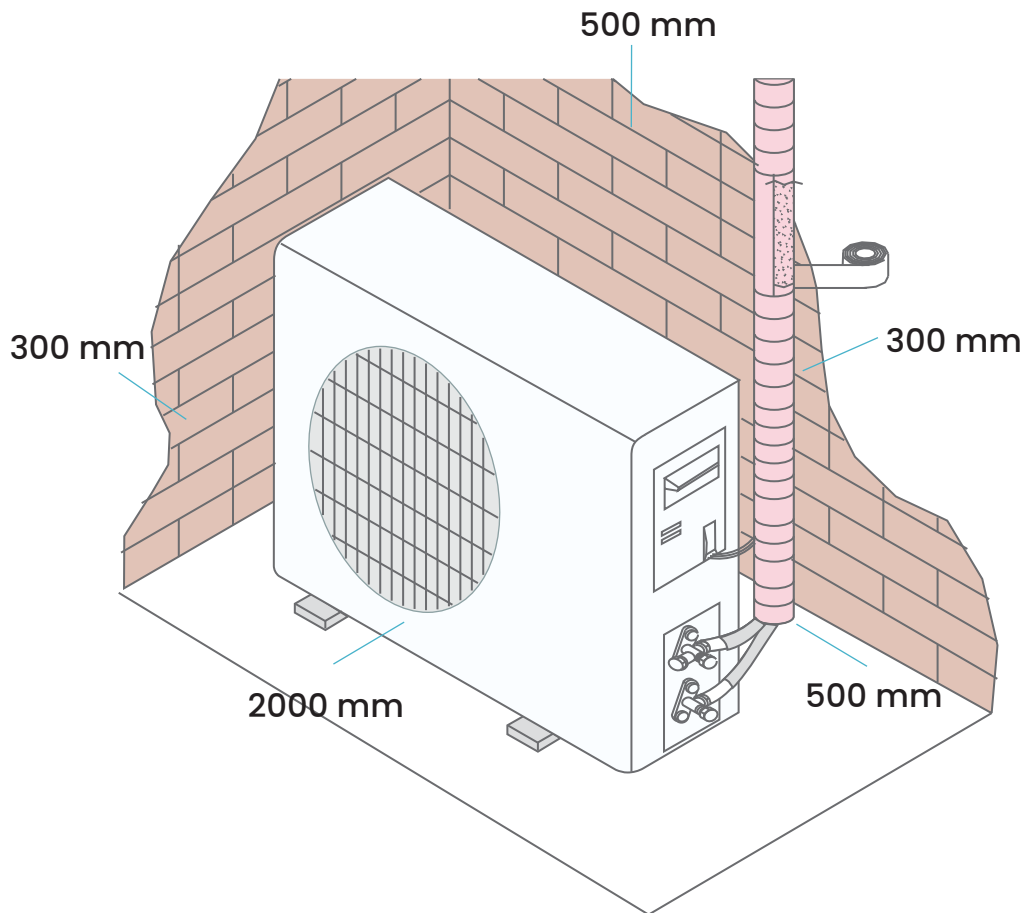

OUTDOOR UNIT

- The outdoor unit should be installed on a solid wall and fastened securely. Before connecting the pipes and connecting cables, decide which is the best position on the wall and leave enough space to be able to carry out maintenance easily.
- Fasten the support to the wall using screw anchors, which are particularly suited to the type of wall. Use a larger quantity of screw anchors than normally required to avoid vibration during operation and so that they remain fastened for years without becoming loose.
- Do not install the outdoor unit near sources of heat, steam or flammable gas. Do not install the outdoor unit in windy or dusty places.
- Do not install the outdoor unit in places with high human traffic.
- Choose to install the outdoor unit where the air discharge and operating sound will not disturb others.
- Avoid installing the outdoor unit where it will be exposed to direct sunlight. If this is unavoidable, protect it by using shading.
- Leave the spaces for the air to circulate freely.
- Install the outdoor unit in a safe and stable place.
- If the outdoor unit is subject to vibration, place rubber gaskets on its feet.
- It is recommended to use IFB unique ODU stand which is best suited for IFB Ac's.

NOTE: The unit must be installed following all national regulations.

INSTALLATION DIAGRAM

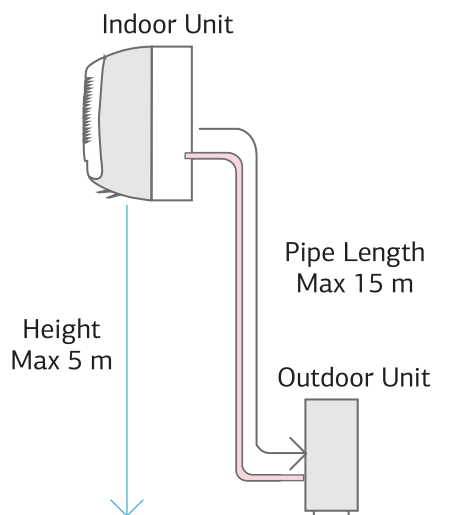
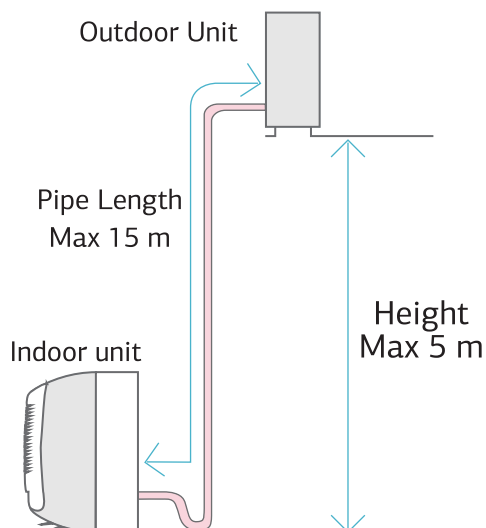

OUTDOOR UNIT

The purchaser must ensure that this air conditioner is installed by persons qualified and experienced in the installation, service and repair of refrigerant products.

Installation of the mounting plate

- Using a level, place the mounting plate in a perfect square position vertically and horizontally.
- Drill 32 mm deep holes in the wall to fix the plate.
- Insert the plastic anchors into the hole.
- Fix the mounting plate by using the tapping screws provided.
- Check that the mounting plate is correctly fixed.

NOTE: The shape of the mounting plate may be different from the one above, but the installation method is similar.

Drilling a hole in the wall for the piping

- Decide where to drill the hole in the wall for the piping (if necessary) according

- to the position of the mounting plate.
- The hole must slope downwards towards the exterior.

NOTE: Slant the drain pipe downwards in the direction of the hole; otherwise leakage may occur.

Electrical connections

- Lift the front panel.
- Take off the cover as indicated in the figure (by removing a screw).
- For the electrical connections, see the circuit diagram on the right side of the unit under the front panel.
- Connect the cable wires to the screw terminals by following the numbering. Use wire size suitable to the electric power input (see name plate on the unit) and according to all current national safety code requirements.
- The cable connecting the outdoor and indoor units must be suitable for outdoor use.
- The plug must be accessible after the air conditioner has been installed so that it may be pulled out if necessary.

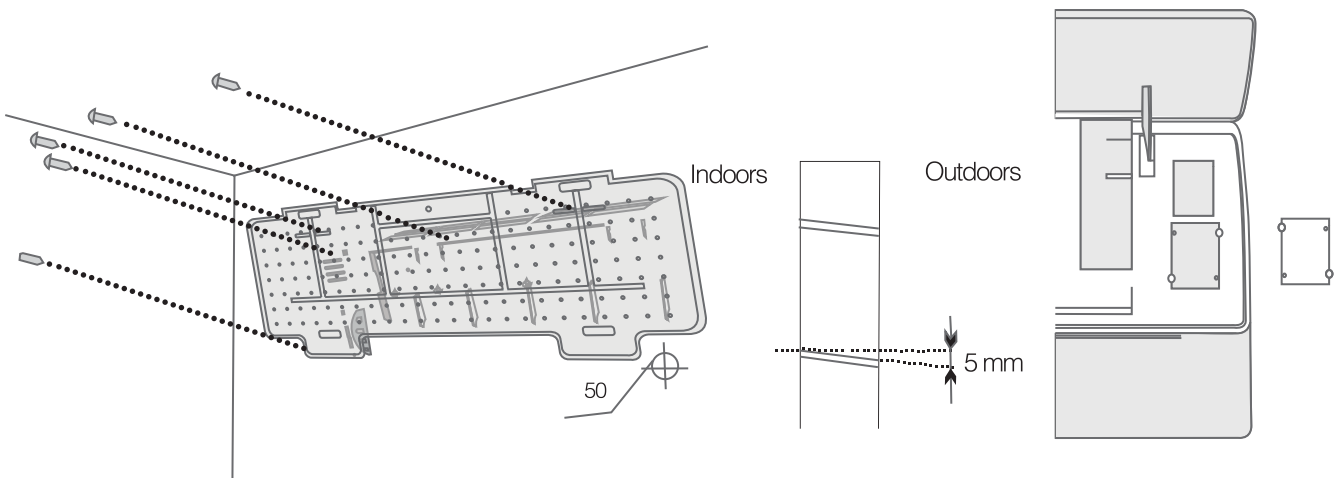

- The connection must have sufficient earthing.
- If the power cord is damaged, it must be replaced by authorized service personnel only.

NOTE: The cable wires have been connected to the main PCB of the indoor unit by the manufacturer according to the model without terminal block.

Refrigerant piping connection

- The piping can move in 3 directions as indicated by numbers in the figure.
- When the piping is moving in direction 1 or 3, cut a notch along the groove on the side of the indoor unit with a cutter.
- Move the piping in the direction of the wall hole and bind the copper pipes, the drain pipe and the power cables, together with tape with the drain pipe at the bottom, so that water can flow freely.

Connecting the pipes

- Shape the connection pipe
- Do not remove the cap from the pipe until connecting it, to prevent dampness or dirt from entering it.
- If the pipe is bent or pulled too often, it

- will become stiff. Do not bend the pipe more than three times at one point.
- When extending the rolled pipe, straighten the pipe by unwinding it gently as shown in the figure.

Connections to the indoor unit

- Remove the indoor unit pipe cap. Check that there is no debris inside.
- Insert the flare nut and create a flange at the extreme end of the connection pipe.
- Tighten the connections by using two wrenches working in opposite directions.

Indoor unit condensed water drainage

- Place the drain hose below the piping, taking care not to create siphons.
- The drain hose must slant downwards to aid drainage.

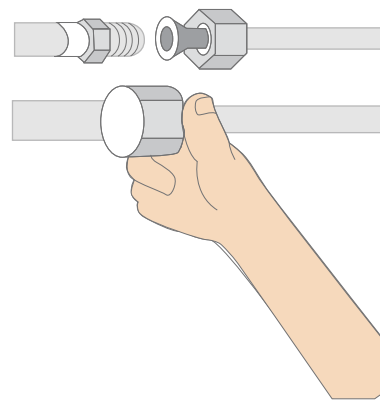
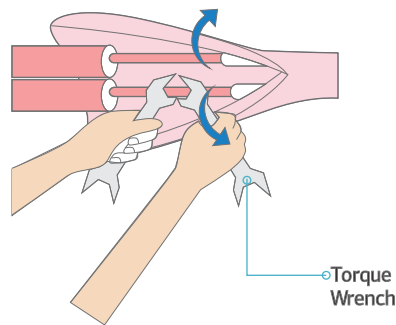
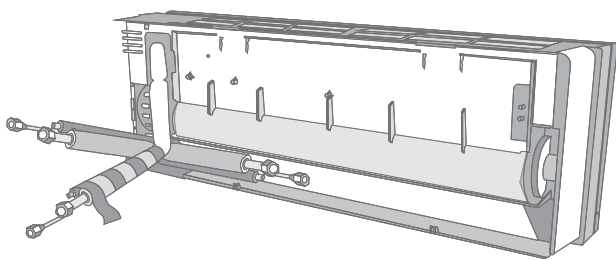
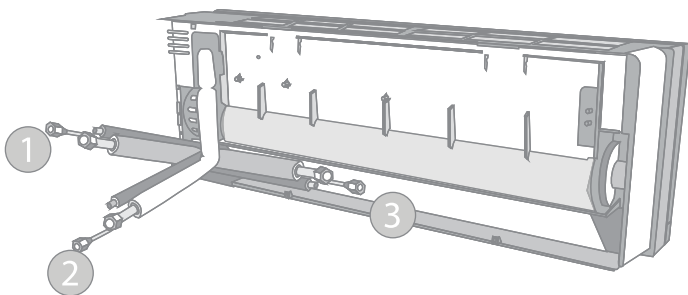

- Do not bend the drain hose or leave it protruding or twisted and do not put the end of it in water. If an extension is connected to the drain hose, ensure that it is lagged when it passes into the indoor unit.
- If the piping is installed to the right, the pipes, power cable and drain hose must be lagged and secured onto the rear of the unit with a pipe connection.
- Insert the pipe connection into the relative slot.
- Press to join the pipe connection to the base.

Installation of the indoor unit

- After having connected the pipe according to the instructions, install the connection cables.
- Now install the drain pipe. After connection, lag the pipe, cables and drain pipe with the insulating material.
- Arrange the pipes, cables and drain hose well.

- Lag the pipe joints with insulating material, securing it with vinyl tape.
- Run the bound pipe, cables and drain pipe through the wall hole and mount the indoor unit onto the upper part of the mounting plate securely.
- Press and push the lower part of the indoor unit tightly against the mounting plate.

Installation of the outdoor unit

Outdoor unit condensed water drainage (only for heat pump models)

The condensed water and the ice formed in the outdoor unit during heating operation can be drained off through the drain pipe

- Fasten the drain port in the 25 mm hole placed in the part of the outdoor unit.
- Connect the drain port and the drain pipe. Ensure that the water is drained in a suitable place.

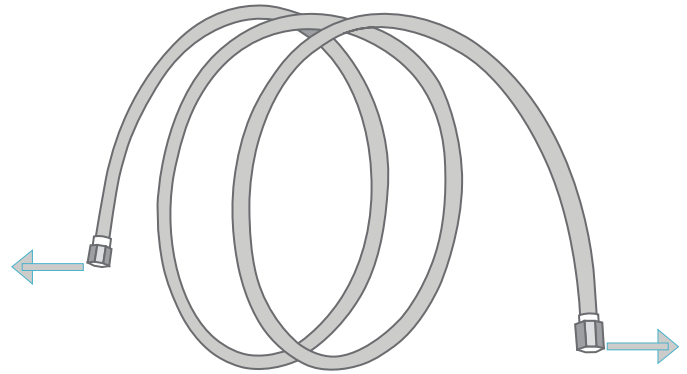
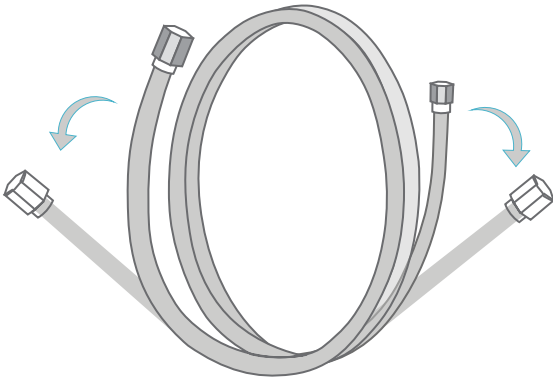

Electrical connections

- Remove the cover.
- Connect the cable wires to the terminal board using the same numbering as in the indoor unit.
- For the electrical connections, see the wiring diagram on the top cover of the Control Box.
- Fasten the cables with a cable clamp.
- The connection must have sufficient earthing.
- Refit the covers.

procedures described for the indoor unit. To avoid leakage, pay attention to the following

- Tighten the flare nuts using two wrenches. Pay attention not to damage the pipes.
- If the tightening torque is not sufficient, there will probably be some leakage. With excessive tightening torque there will also be some leakage, as the flange could be damaged.

Connecting the pipes

Screw the flare nuts to the outdoor unit coupling with the same tightening

NOTE: The surest system consists of tightening the connection by using a fixed wrench and a torque wrench. In this case, refer to the table below.

| Pipe | Tightening Torque (N x m) | Corresponding Stress (Using a 20 cm Wrench) | | Tightening Torque (N x m) |
|------------------|---------------------------|---|------------------|---------------------------|
| 1/4" (Ø6.35) | 15-20 | Wrist Strength | Service Port Nut | 7-9 |
| 3/8" (Ø9.52) | 31-35 | Wrist Strength | Protection Caps | 25-30 |
| 1/2" (Ø12.7) | 35-45 | Wrist Strength | | |
| 5/8" (Ø15.88) | 75-80 | Wrist Strength | | |

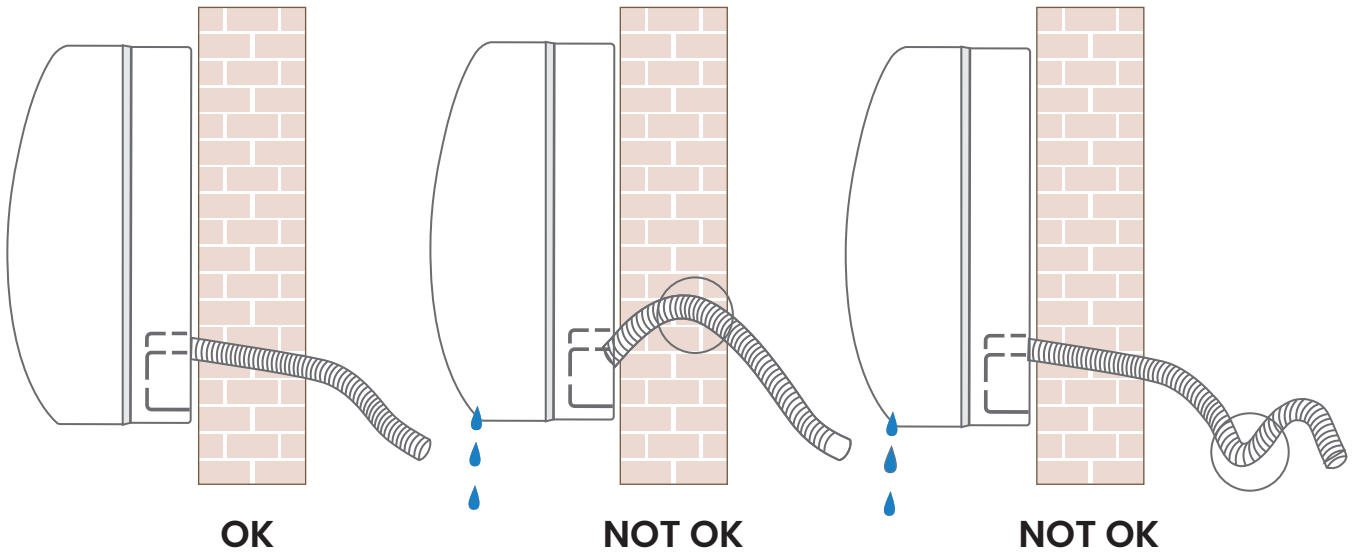

VACUUMING

Air and humidity left inside the refrigerant circuit can cause compressor malfunction. After having connected the indoor and outdoor units, remove the air and humidity from the refrigerant circuit by using a vacuum pump.

NOTE: Only persons or companies qualified and experienced in the installation, service and repair of refrigerant products should be permitted to do so. The purchaser must ensure that the person and/or company who is to install, service or repair this Air conditioner has qualifications and experience in refrigerant products.

After completing the piping, purge the air from the connected pipe and cooling unit. If this is not done, the discharge pressure will rise abnormally and may damage the refrigerating-cycle unit.

AIR PURGING USING A VACUUM PUMP

Remove the valve cap of the valve core.

Connect one end of the charge hose to the vacuum pump and the other end to the service valve with the large diameter pipe side service valve.

Fully open the LO knob of the manifold valve and energize both solenoid valves.

Run the vacuum pump.

Vacuum the AC as recommended.

Close the LO knob of the manifold valve.

Stop the vacuum pump.

Remove the valve cap from the spindle of the service valve.

Turn the spindles of the large and small diameter pipe side service valves fully counter-clockwise until they are securely tightened. Then, retighten them more than 10 degrees using a hexagon wrench key of 4/5 mm.

Disconnect the charge hose from the service valve.

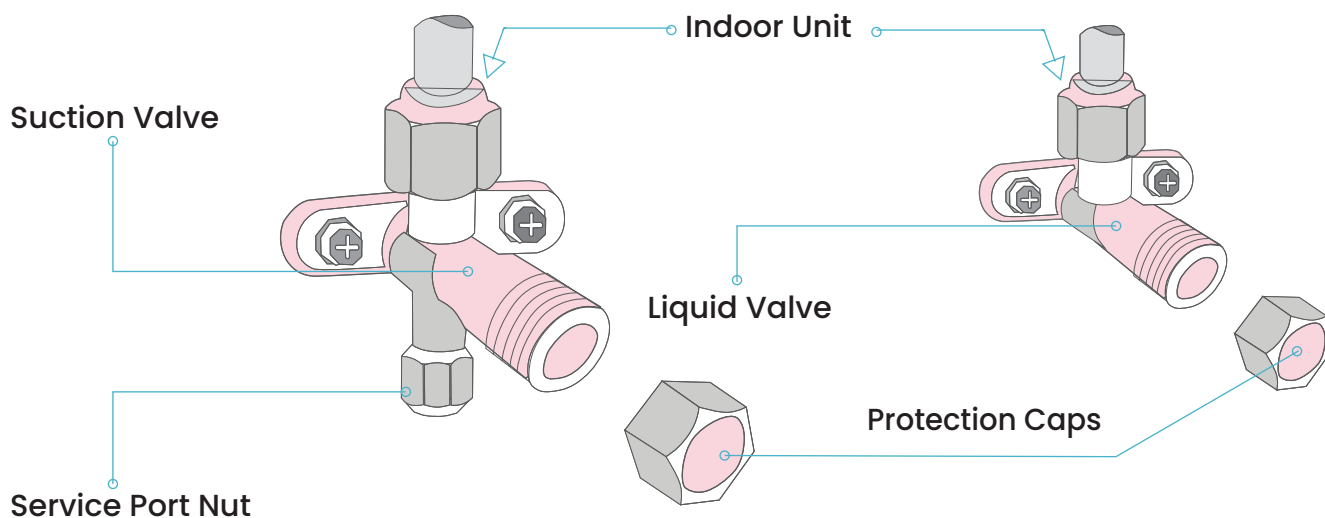

Final stage of installation

- Place wind insulating covering around the joints of the indoor unit and fix it with insulating tape.
- Fix the exceeding part of the signal cable to the piping or to the outdoor unit.
- Fix the piping to the wall (after having coated it with insulating tape) using clamps or insert them into plastic slots.
- Seal the hole in the wall through which the piping is passed so that no air Or water can fill.

Indoor unit test

- Do ON/OFF and fan operate normally?
- Do the various modes operate normally?
- Does the Timer function properly?
- Does each LED function normally?
- Do the flaps for airflow direction operate normally?
- Is the condensed water drained regularly?

Outdoor unit test

- Is there any abnormal noise or vibration during operation?
- Could the noise, airflow or condensed water drainage disturb the neighbours?
- Is there any coolant leakage?

NOTE: The electronic controller starts the compressor three minutes after voltage has reached the system.

Key information for installer

| Inverter Type Capacity (Btu/h) | 12k | | 15/18k | 22/24k |
|---|------------------|------------------|------------------|------------------|
| Liquid pipe diameter | 1/4" (Ø 6.35) | | 1/4" (Ø 6.35) | 1/4" (Ø 6.35) |
| Gas pipe diameter | 3/8" (Ø 9.52) | 1/2" (Ø 12.7) | 1/2" (Ø 12.7) | 1/2" (Ø 12.7) |
| Length of pipe with standard charge | 3 m | 3 m | 3 m | 3 m |
| Maximum distance between indoor and outdoor unit | 15 m | 15 m | 15 m | 15 m |
| Additional refrigerant charge | 20 g/m | 20 g/m | 20 g/m | 20 g/m |
| Maximum difference in level between indoor and outdoor unit | 5 m | 5 m | 5 m | 5 m |
| Type of refrigerant | R32 | R32 | R32 | R32 |

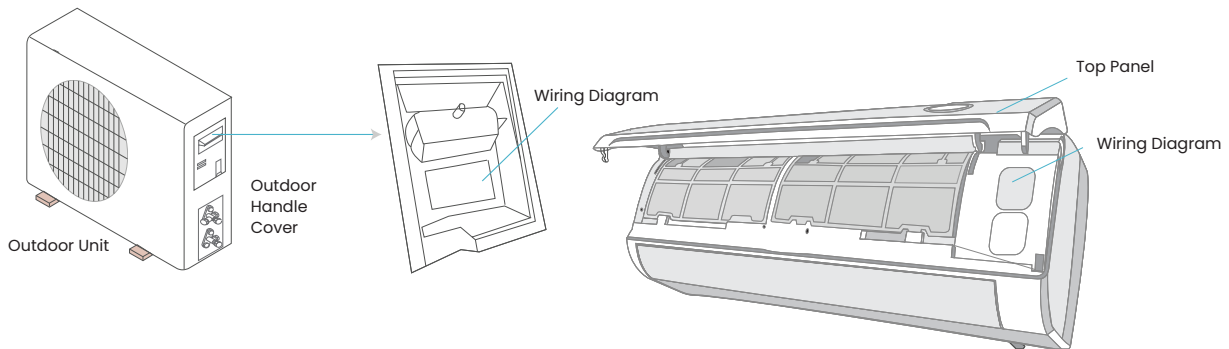



Wiring diagram

Indoor Unit : Under the front panel & over the control box cover as shown above in 1.

Outdoor Unit : Under the top panel & over the control box cover OR at the back side of the outdoor unit handle cover* as shown above in 2.

*Wiring diagram may vary according to model.

Cable wire specifications

| Model Capacity (Btu/H) | | 12K | 18K | 24K |
|-------------------------|---|---------------------|---------------------|---------------------|
| | | Sectional Area | | |
| Power supply cable | N | 1.0 mm ² | 1.5 mm ² | 1.5 mm ² |
| | L | 1.0 mm ² | 1.5 mm ² | 1.5 mm ² |
| |  | 1.0 mm ² | 1.5 mm ² | 1.5 mm ² |
| Connection supply cable | N | 1.0 mm ² | 1.5 mm ² | 1.5 mm ² |
| | L | 1.0 mm ² | 1.5 mm ² | 1.5 mm ² |
| | 1 | 1.0 mm ² | 1.5 mm ² | 1.5 mm ² |
| |  | 1.0 mm ² | 1.5 mm ² | 1.5 mm ² |

NOTE:

Wire diameters are as per American wire gauge (AWG) standard.

Type of fuse used on indoor unit controller for 12k, 15k, 18k, 22k, 24k, 24k and 30k is rated 4A, 250 V.

Type of fuse used on inverter outdoor unit controller for 12k is rated 15 A, 250 V. Type of fuse used on inverter outdoor unit controller for 18k, 22k and 24k is rated 20 A, 250 V.

3. MAINTENANCE AND CLEANING

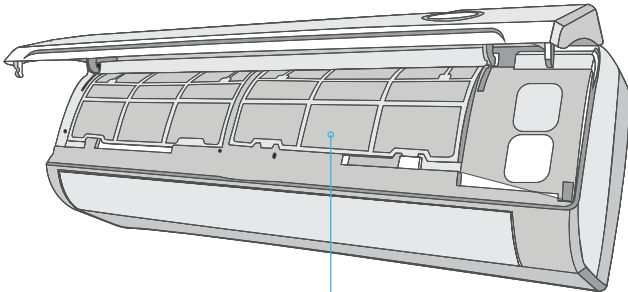

Anti Dust Filter

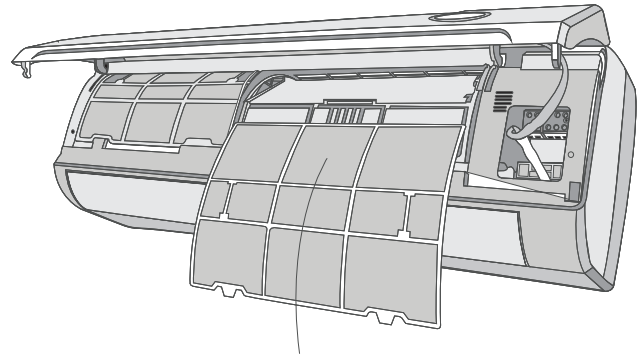

Periodic maintenance every 2 weeks is essential for keeping your air conditioner operating efficiently. Before carrying out any maintenance, disconnect the power supply by switching OFF the air conditioner.

Filter Clean Indicator

- When AC is operated for a total of about 200 Hours, the fan icon on IDU display will start blinking and indoor unit will beep thrice.
- This indicates that it is time to clean the air filters.
- This blinking and beep sound will automatically stop after 30 minutes or power ON/OFF of AC.

NOTE: Customers who are regularly cleaning the air filters after two weeks can ignore this indication.

Replacing the Batteries

- Take off the back cover of the remote control. Place the new batteries in the Alignment "+" and "-" symbols.
- Use only new batteries. Remove the batteries from remote control when the air conditioner is not in operation.

The remote control's batteries must be disposed off in accordance with the applicable laws in force in the country of use.

Cleaning the air filters

- Open the front panel following the direction of the arrow.
- Keeping the front panel raised with one hand and take out the air filter with the other hand.
- Clean the filter with water. If the filter is soiled with oil, it can be washed with warm water (not exceeding 45°C).
- Leave to dry in a cool, dry place.
- Keeping the front panel raised with one hand, re-insert air filter with the other hand and close the front panel.
- The Vitamin C and activated carbon filters (if installed) cannot be washed or regenerated and must be replaced every 6 months.
- Do not wash special filters.
- Fragrance diffusers if used must be replaced in 3 - 4 weeks.

Cleaning the Aesthetics

- Use Damp cloth (with water) only to clean the Aesthetics surface of Indoor unit.

4. USEFUL INFORMATION

Troubleshooting

Make sure you have installed the air conditioner in accordance with the installation instructions.

If the air conditioner does not start, check the following probable causes before you contact your service provider.

| Problem | Possible Cause | Solution |
|---|--|---|
| Air conditioner does not start | Air conditioner is unplugged | Make sure the air conditioner plug is fixed properly in the power socket. |
| | Fuse is blown/circuit breaker has tripped | Check the fuse/circuit breaker and replace the fuse or reset the breaker. |
| | Power outage | Switch OFF the main power supply. Switch it back ON once the power resumes. |
| Air conditioner does not cool as it should. | Airflow is restricted | Make sure there are no curtains, blinds or furniture blocking the airflow |
| | Air filter is dirty | Clean the filter every 2 weeks. (Refer Maintenance and cleaning). |
| | Room is too hot | After the air conditioner is switched ON, allow time for the room to cool down. |
| | Cold air is escaping | Check whether any door/window in the room is open. If so, close them to avoid leakage of cold air. |
| Air conditioner displays error code | Display shown error code such as E1, E2 etc | Contact IFB Care. |
| Fog or Mist coming from AC | Temperature is set too low Fan Speed is Set at Low Speed Clogged Filter Clogged Heat Exchangers | In high humid conditions, when the temperature is set at low, this phenomena is common Increase the Fan speed to high fan speed Clean the Filters Contact IFB care |
| Cracking sound coming from AC | Temperature is set too low | This is a normal Phenomena which occurs due to contraction / expansion of plastic parts. |

Before contacting IFB Care, make sure you have the make, model and serial number of your air conditioner on hand. The IFB Service Centre will require this information.

INSTALLATION REPORT

Model _____ Serial No _____

Customer's name _____

Phone (Residence) _____ (Office) _____

Address _____

Installation check points

Machine delivered on _____

Machine installed on _____

Service engineer to tick appropriately

- Air conditioner checked for damage? Yes No
- Tapes removed from the front cover? Yes No
- All packaging waste from customer's premises cleared with customer's prior permission? Yes No
- Strength of installation of both indoor and outdoor units sufficient? Yes No
- Direction of condenser of machine? North/South/East/West
- If condenser is towards South or West, is proper shade provided? Yes No
- Installation of indoor unit as per distance guide below?

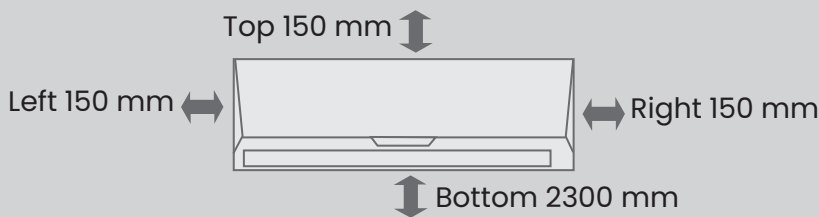

- Actual distances
- Top _____ mm
- Bottom _____ mm
- Left _____ mm
- Right _____ mm

- Installation of outdoor unit as per distance guide below?

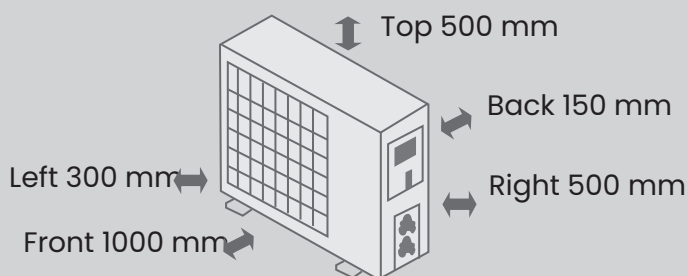

- Actual distances
- Top _____ mm
- Front _____ mm
- Back _____ mm
- Left _____ mm
- Right _____ mm

Service engineer to tick appropriately

- Is the indoor unit level breadthwise and depthwise and is the drain pipe free of air locks?

Yes No

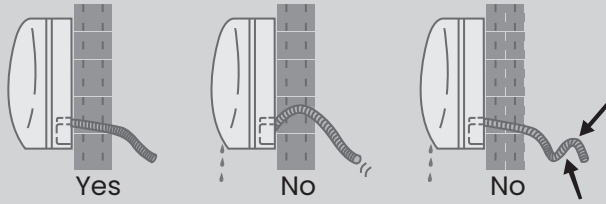

- Is the drain hose inclined to ensure a smooth flow of condensed water?

Yes No

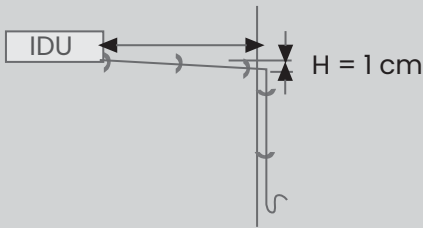

- Has a proper slope been maintained towards the drain outlet to ensure a smooth flow of drain water? (Use horizontal level gauge)

Yes No

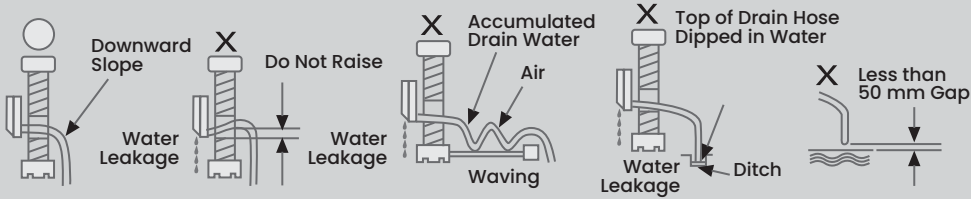

- Is the heat insulative material securely attached to the connections on the piping of the indoor unit?

Yes No

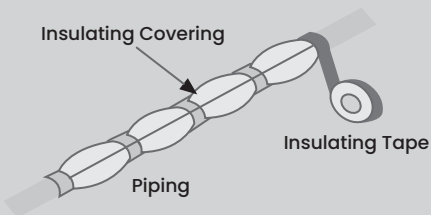

- Has putty been applied to close the piping hole on both sides to avoid air leaks and water coming inside?

Yes No

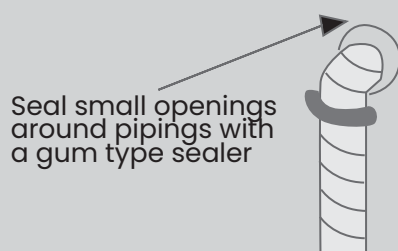

Service engineer to tick appropriately

- Are the air outlets of the indoor and outdoor units free of obstacles? Yes No
 - Has each of the pipe connections been checked for gas leaks? Yes No
 - Is the voltage at the exclusive power outlet within the range of rated voltage +/- 10% of standard 220 volts? Yes No
 - Are the fuse and wire gauge used of the following specifications? Yes No
- | | | | |
|-------------------|--------------------|--------------------|--------------------|
| | 12K | 18K | 24K |
| Fuse (MCB Rating) | 12A | 16A | 16A/25A |
| Wire Size | 1.5mm ² | 1.5mm ² | 1.5mm ² |
- Run the machine for 30 minutes and check for the following:
 - a) Vibration/abnormal noise heard? Yes No
 - b) Electric power supply input volts and earthing for the unit
 - 1) Voltmeter reading more than 100 mV and less than 3 V between N&E? Yes No
 - 2) Supply between L&E - Rated Voltage +/-10%? Yes No
 - 3) Supply between L&N - Rated Voltage +/- 10%? Yes No
 - N = Neutral, L = Line, E = Earth
 - Temperature readings taken
 - Indoor Unit Return Air Temp _____ °C (T1) Yes No
 - Indoor Unit Supply Air Temp _____ °C (T2) Yes No
 - Delta T = _____ (T1- T2) between 8-14 °C? Yes No
 - Checked drainage of condensed water from evaporator side to drain outlet by pouring water at the base of evaporator coil? Yes No

Installed by _____ Signature _____

Customer's response

The installation person was courteous and helpful yes no

I would describe my experience with the process of installation as
 Unacceptable Satisfactory Non-satisfactory Very satisfactory

I certify that the above information and checks have been done to my satisfaction and I am fully satisfied with the installation of the air conditioner

Customer's signature

Date

Time

Full load and half load capacity test modes are applicable only for testing purpose in authorized test laboratories. Before setting the mode, lab conditions to be stabilized as per IS1391 Part 2.

Full Load (100%) Capacity settings:

Step 1: By using remote controller turn ON the unit .

Step 2: Set Cool mode at 30°C set temperature and Fan speed medium.

Step 3: Press Sleep button continuously for 7 times within 10 sec.

Step 4: IDU will beep thrice.

Step 5: Change the set temp to 25°C.

Step 6: Full load test setting will be activated & IDU display will show " **FL** ".

Half Load (50%) Capacity settings:

Step 1: By using remote controller turn ON the unit .

Step 2: Set Cool mode at 30°C set temperature and Fan speed medium.

Step 3: Press Sleep button continuously for 7 times within 10 sec.

Step 4: IDU will beep thrice.

Step 5: Change the set temp to 26°C.

Step 6: Full load test setting will be activated & IDU display will show " **HL** ".

NOTE:

During cooling capacity test vertical louver should be in straight position.

WARRANTY

IFB AIR CONDITIONERS, TERMS AND CONDITIONS

For safety and as a standard operating practice, it is important to install the air conditioner with an MCB, with proper provision of electrical earthing. Always ensure that the MCB is in ON condition and not in a bypass condition.

ONE YEAR STANDARD WARRANTY*

IFB Industries Ltd (IFB) (the Company) warrants to the original domestic purchaser of this air conditioner (appliance) that it is free from defects in workmanship and materials. During 12 months, starting from the date of purchase of the new air conditioner, all the parts of the air conditioner which prove to be defective as a result of workmanship and/or materials, shall be replaced or repaired free of charge (except for the parts described in this warranty as beyond the scope of the above) on intimation to the Company/Company's authorized service center nearest to the place where the appliance is installed.

*Plastic and rubber parts, sheet metal/paint affected by environment led rusting on exposure and damages to the remote as a result of poor handling are not covered under the warranty.

ADDITIONAL WARRANTY PARTS

Compressor

After Expiry of Standard Warranty of 1 year, an additional warranty of 9 years will be provided on the inverter compressor. During this extended warranty period, IFB will repair/replace the compressor. This is subject to an inspection by IFB of the compressor and proof that the air conditioner has been serviced throughout the life only by IFB's authorized service franchise. The repair/replacement shall be valid for manufacturing defects only. For compressor failures gas charging and labour costs will be chargeable.

PCB/CONTROLLER (OUTDOOR PCB ONLY)

After Expiry of the Standard Warranty of 1 year, an additional warranty of 4 years will be provided on the outdoor PCB only. During this extended warranty period, IFB will repair/replace the PCB (Outdoor PCB Only) which proves upon inspection by IFB or its authorized service franchisee to be found defective due to manufacturing defect.

FOUR YEARS ASSURANCE ON PRODUCT*

After Expiry of the Standard Warranty of 1 year, an additional "Assurance of 4 years" will be provided on the outdoor PCB, Indoor PCB, Fan Motors, Swing Motors only. This will be valid only on the appliance as provided first hand by the Company. During this Assurance period, functional parts other than sheet metal and plastic parts shall be covered for replacement/repairs. Any additional expenses or visit charges shall be extra and is not covered under the scope of Assurance.

This will be subject to inspection by IFB and proof that the air conditioner has been serviced throughout the product life only by IFB's authorized service franchise. Replacement/of repair of parts shall be valid for manufacturing defects only.

Assurance is applicable and remain valid provided Customer avails two annual preventive maintenance service every year by logging call with IFB contact centre from 2nd year till the 5th year (on chargeable basis as prevalent at the time of call logging), which will be carried out by an authorized service franchise of IFB.

*Plastic and rubber parts, sheet metal/paint affected by environment led rusting on exposure and damages to the remote or other parts as a result of poor handling are not covered under the scope of Assurance

Any additional service maintenance cost will be on chargeable basis. Assurance shall be applicable on models as decided by IFB.

NOTE: IFB shall not honour any warranty/super warranty related claims for the air conditioners installed and/or serviced/repared or parts modified by unauthorized service providers. The one-year warranty and additional four year Assurance are subject to the following.

TERMS & CONDITIONS

1. This warranty is not valid in case of the following events:
 - A) If the warranty card is not fully and properly filled in and signed at the time of purchase/ installation by the Company's authorized franchisee/dealer/service engineer.
 - B) If the completed warranty card is not presented to the authorized personnel at the time of service/repair. Customers may be asked to furnish proof of ownership and date of purchase by showing the sales receipt/purchase invoice. The warranty claims as accepted will be only for the original purchaser. The warranty is non-transferable to anyone who subsequently purchases, leases or otherwise obtains the product from the original purchaser.
 - C) If the appliance is not used in accordance with the manufacturer's instructions given in the user manual.
 - D) If the air conditioner has been installed, serviced, repaired, opened or tampered with by unauthorized personnel.
 - E) If defects arise/are caused by accidents, alteration, misuse, neglect, abuse, substitution of original components with spurious/non genuine components, use of/application of harmful chemicals on machine, attack by household pest/rodents, fire, flood, earthquake, lightning, and/or any other acts of God/natural calamities.
 - F) If defects arise with optional accessories like stabilizer, machine covers, extended power cables, outdoor unit stands, remote controls (except external damage/mishandling), inlet/outlet hoses, control knobs, electrical plugs, other detachable parts etc.
 - G) If damages occur owing to improper electrical circuits outside the air conditioner or by any external electrical supply thereof. This includes failures due to erratic power supply, fluctuations beyond rated voltage $\pm 10\%$ voltage and frequency of 50 Hz $\pm 3\%$, AC power supply systems.
 - H) If the machine is run frequently on power back-up or solar power.
 - I) If the machine serial number on the appliance is defaced, missing or altered.
 - J) If the appliance is taken out of the territory of the Republic of India.
 - K) This warranty will automatically terminate on the expiry of the warranty period of 12 months or extended warranty (optional) as per the scheme, even if the air conditioner has not been in use for any time during the warranty period or extended warranty period for any reason.
2. This warranty does not cover normal wear and tear, any type of corrosion, rust, stains, scratches, peeling paint, dents on the body. Also, the Company is not liable for any incidental or consequential damages.
3. Parts replaced or repaired under Standard and Extended Warranties are warranted throughout the remainder of the original warranty period.
4. The Company is not liable for any delay in servicing owing to reasons beyond the control of the Company or any of its authorised service centres.
5. This warranty is not applicable if the air conditioner is used for commercial / semi - commercial purposes.
6. For any service under warranty beyond city/town/municipal limits from the Company/authorised service centres, a fixed charge as per the Company's norms will be collected from the customer, in addition to the actual to and fro charges by the shortest route. Alternatively, the customer may bring the appliance to the nearest service centre for carrying out the necessary repairs, at customers own cost.
7. The warranty does not cover regular maintenance, including cleaning of filters, drain tray and condenser wet servicing.

TERMS & CONDITIONS

8. The Company shall not be liable for any damage arising out of poor or inadequate maintenance by unauthorized personnel, improper voltage (voltage surge, excessive voltage etc) or overloading of the air conditioner.
9. The Company shall not be liable for any damage to property or any loss incurred/caused in the process of carrying out repair or servicing of the air conditioner if it is installed in positions or locations which make it difficult or unreasonable for such damage to be avoided.
10. The warranty does not cover the cost of providing access to any air conditioner by whatever means necessary, for the purpose of carrying out repairs or servicing, in the event that the location or position at which the air conditioner is installed is such that there is no reasonable access to the air conditioner for such repairs or servicing to be carried out.
11. While the Company endeavours to repair any defect, it is subject to availability of parts from its manufacturers.
12. IFB reserves the right to change, add or delete any terms and conditions herein at any time without prior notice.
13. The warranty shall be governed by and construed in accordance with the laws of the Republic of India.
14. The customer shall comply with the applicable waste guidelines. Any defective parts replaced even after the warranty period shall be handed over to authorized representatives of the Company for environment friendly disposal.
15. According to the Waste regulations, the life of the air conditioner is 10 years. There shall not be any liability of the Company towards machine/service/availability of spares after 10 years of the first sales invoice of such machine, even on payment basis.
16. Customers are eligible to avail 2 preventive maintenance services during the first year of the warranty free of cost. However, in no circumstance may the customer extend or avail these services beyond the first year of warranty. The customers may avail the 2 free services by registering a complaint with the Company's Customer Care only.