

cromā
A **TATA** Product

CROMA UHD LED TV

Model Name	Model Number
43" UHD LED TV	CREL043UGC0333801
55" UHD LED TV	CREL055UGC0333801



CONTENTS

KNOW YOUR PRODUCT

- Package Contents
- Technical Specifications
- Features
- Understanding Your Television
- Connecting to External Devices
- General Settings
- Channels and Inputs
- Picture and Sound

INSTALLING YOUR TELEVISION

- Wallmount Instructions
- Remote Control
- Pairing the Bluetooth remote control with your TV

SAFETY INSTRUCTION

- General Safety Instructions
- Product Usage Warning

REGULATIONS AND LICENSE

- E-Waste Management Policy
- Product Packaging
- Important Instructions
- Bee Attention
- License

TERMS AND CONDITIONS

- ANNEXURE A

WARRANTY CARD

KNOW YOUR PRODUCT

Package Contents

This package contains the items listed below. In case any of the listed items are missing, immediately contact Croma Customer Care at 1800-572-7662.

S/N	Items	Qty
1	Main Unit	1
2	TV Stand	2
3	Wall Mount Kit	1
4	Power Cord (for 55")	1
5	Remote Control	1
6	AAA Batteries	2
7	User Manual	1
8	TV Stand Screws	4
9	Mini AV Lead (for 55")	1

Understanding Your TV

1. Power Key

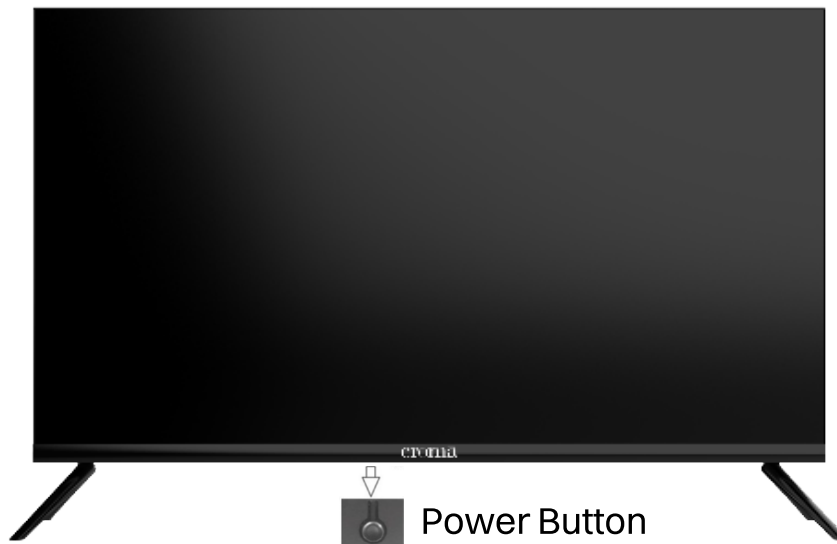

1. Press the button to turn the unit ON from STANDBY mode.
2. Press it again to turn the set back to STANDBY



NOTE

The picture is for reference only. Please refer to the real product as standard. Attachments and accessories may vary depending on the model you have purchased.

2. Rear side of TV

On the rear side of the TV set following connectivity options are available

43" UHD

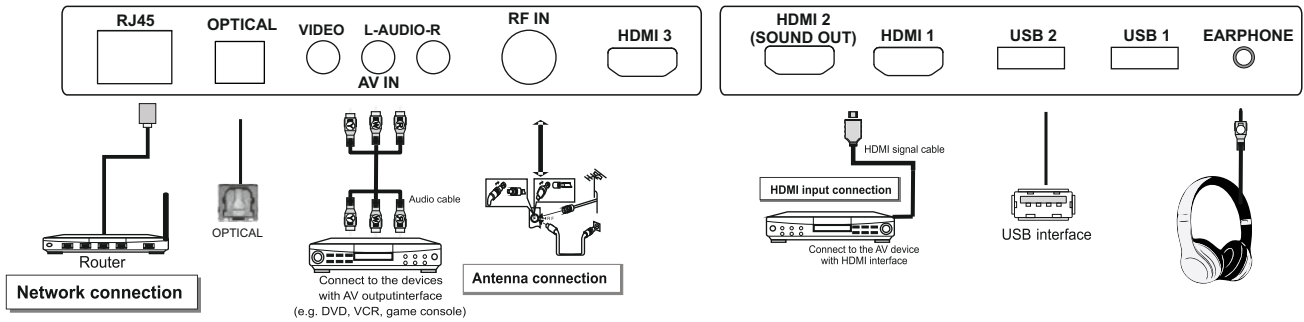

55" UHD

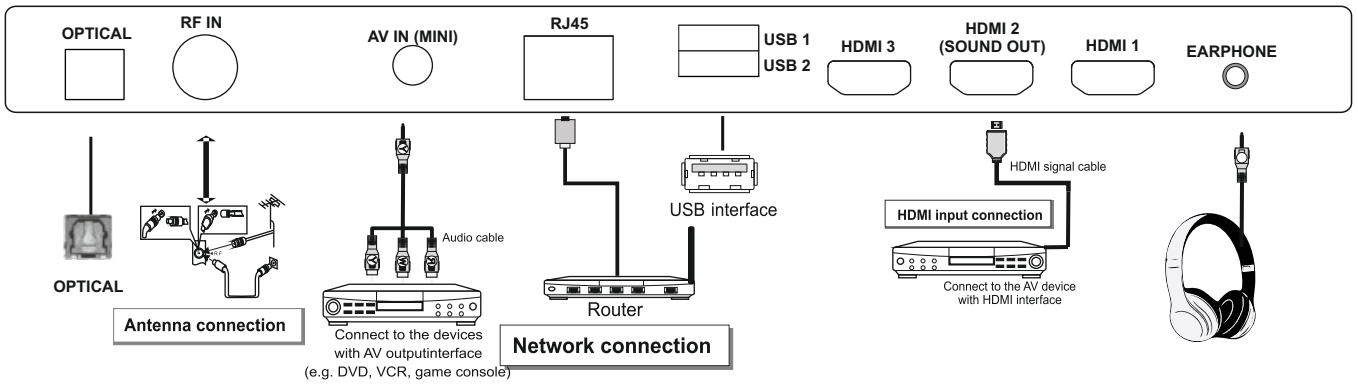

NOTE

The picture is for reference only. Please refer to the real product as standard. Attachments and accessories may vary depending on the model you have purchased.

1. RJ 45 LAN:

Plug-in network RJ 45 plug to connect to an external modem or network access equipment.

2. AV Input:

The AV IN sockets can be used to connect a range of equipment, including AV IN AUDIO video recorders, camcorders, decoders, satellite receivers, DVD players, or gaming consoles. The VIDEO IN socket provides a composite video connection.

3. HDMI 3/HDMI 2/HDMI 1 Socket (Input):

The HDMI (High-Definition Multimedia Interface) socket can be used to connect with a HDMI-PC with a compatible video card, certain DVD players, or an HD-compatible digital satellite decoder. This socket provides an uncompressed digital connection that carries both video and audio data by way of an integrated mini-plug cable. The ARC (Audio Return Channel) function is only supported on HDMI 2 (ARC) port UHD.

4. Digital Audio Out:

Use a digital optical cable to connect your TV to a compatible audio receiver.

5. RF/ANTENNA IN Socket (input):

Let's you connect a coaxial cable to receive the signal from your antenna, cable or cable box.

6. USB Interface:

Insert a compatible thumb drive for image, audio and video playback.

Features

- Resolution: 3840x2160
- A+ Grade Panel
- Digital Audio Out
- Dual Band Wi-Fi - 2.4GHz & 5GHz
- Google TV
- Bluetooth Connectivity v5.0
- 3x HDMI, 2x USB

Technical Specifications

Specifications	CREL043UGC0333801	CREL055UGC0333801
Screen Size	43"UHD/109 cm (Diagonal)	55"UHD/140 cm (Diagonal)
Resolution	3840x2160p	3840x2160p
PP Modes	STANDARD, DYNAMIC, CINEMA, ECO, GENTLE, CRICKET, GAME, PERSONAL	STANDARD, DYNAMIC, CINEMA, ECO, GENTLE, CRICKET, GAME, PERSONAL
Audio Output	10W+10W	10W+10W
Sound Modes	STANDARD, CINEMA, MUSIC, NEWS, PERSONAL	STANDARD, CINEMA, MUSIC, NEWS, PERSONAL
ANT.	x1	x1
AV IN	x1	x1
HDMI	x3	x3
USB	x2	x2
Digital Audio	x1	x1
Lan	Yes	Yes
Earphone	Yes	Yes

Specifications	CREL043UGC0333801	CREL055UGC0333801
Video Format	.flv, .mp4, .mpeg, .h.264, .m2ts	.flv, .mp4, .mpeg, .h.264, .m2ts
Audio Format	.mp3, .aac	.mp3, .aac
Picture Format	.jpg, .jpeg, .bmp, .png	.jpg, .jpeg, .bmp, .png
USB Codec Attached	USB 2.0	USB 2.0
Power Supply	100V - 240V, 50/60Hz	100V - 240V, 50/60Hz
Power Consumption	115W	150W
Remote Control unit	x1	x1
Table Top Stand Pair	x1	x1
Wall Mounting Brackets	Yes	Yes
Batteries	x2 AAA size	x2 AAA size
Instruction Manual	Yes	Yes

Connecting to External Devices:

1.HDMI CEC/ARC:

If you would like to use the Audio Return Channel (ARC) feature to send sound from the TV via HDMI cable to a digital sound system, you can connect it to the HDMI (ARC) port of your TV.

By using this feature, you can also control the sound system with your TV remote instead of using the remotes for each device.

Note:

- *HDMI cables must be used to connect HDMI and CEC-compatible devices to your TV.*
- *Use a certified cable with the HDMI logo attached.*
- *The HDMI and CEC features of the connected device must be turned on.*
- *If you connect an HDMI device that is not HDMI and CEC compatible, all the HDMI and CEC control features, like ARC, do not work.*
- *Depending on the connected HDMI device, the HDMI and CEC control features may not work.*
- *If your external audio device does not support Dolby or DTS, PCM is suggested.*

2.Bluetooth Device:

You can connect to devices using Bluetooth technology. Press the Setting button to select Remotes & Accessories> Bluetooth to On.

Note:

- *One Bluetooth speaker or Bluetooth headphone can be connected to the TV all the time.*
- *Some compatibility issues may occur depending on the Bluetooth device's support.*
- *The TV and Bluetooth devices may become disconnected if the distance between them is too long.*
- *A keyboard, mouse, or gamepad connected via USB or Bluetooth technology may not be usable with some apps.*

3.USB:

Connect the USB devices, such as hard drives, USB sticks, and digital cameras, for browsing photos or listening to music.

Note:

- *Support for the USB disk 4GB, 8GB, 16GB, 32GB, 64GB, 128GB, and other common market-size hard drives.*
- *Support format: FAT32, NTFS.*
- *Certain digital cameras may not be compatible with the TV.*
- *A keyboard, mouse, or gamepad connected via USB or Bluetooth technology may not be usable with some apps.*

4.Optical Audio Out:

Connect the optical cable to your TV's optical port to enjoy listening to music through a soundbar or optically supported devices.

Note:

- *Your external audio device should be able to support optical out.*
- *Use a standard optical cable for connection.*

5.Earphone:

Connect the earphone cable to your TV.

Sharing your smart phone or computer screen on the TV:

Mirror content from your mobile device to the TV. View videos, photos, and more from your device on your TV screen.

1. Connect your mobile device and TV to the same network connection.
2. Install the Google Home app on your smart phone.
3. Go to Devices and select 4KDATV on local devices.
4. Select Cast My Screen.
5. The device's screen will be mirrored once you select your TV. If you are using Wi-Fi, the connection may fail, and the screen won't switch. You can close the screen-sharing application with the BACK or EXIT buttons.

Note:

Some mobile devices may not support the casting feature.

WARNING:

- Configure the network settings before using Smart TV applications.
- Slow responses and/or interruptions may occur, depending on your network conditions.
- If you experience a problem using an application, please contact the content provider. According to the circumstances of the content provider, an application's updates or the application itself may be discontinued.
- Depending on your country's regulations, some applications may have limited service or not be supported.
- Changes in application content may be made without prior notice by the service provider.
- Press on the remote control to display the TV homepage.
- Press the Up/Down/Right/Light button and OK to enter the desired apps, functions, or settings.
- Press to return to the homepage.

Note:

Since the connection to the Internet takes time, it's recommended that you wait a few minutes to use the Smart TV feature after you activate the TV from standby mode.

Accessing the TV homepage:

The Google TV homepage allows you to enjoy Internet applications, specially adapted Internet websites, and change your TV settings.

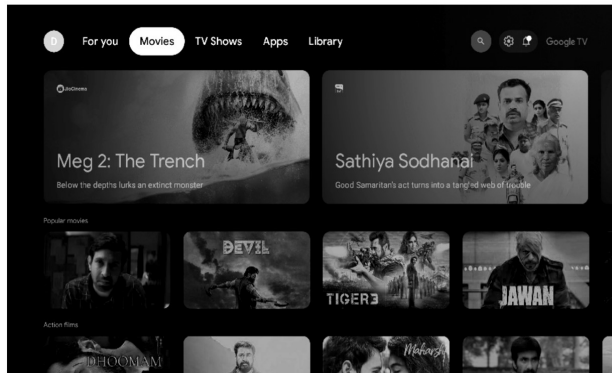

Suggestions

Finish setting up your TV. Add a Google account or sync the registered Google account to make the most of your TV.

Using the TV Settings Menu:

Allow you to configure settings of TV features, such as channels, display and sound, network, accounts, privacy, apps, systems, remotes and accessories, etc.

1. Press the HOME button on the remote control to display the TV homepage.
2. Press ▲/▼/◀/▶ to move the cursor to the right top of the screen, and press OK to enter the settings menu.
3. In the submenus, press ▲/▼ to select menu options, then press OK to enter the option list or the corresponding submenu.
4. Press to return to the previous menu.
5. Press to close the settings menu and return to the homepage.

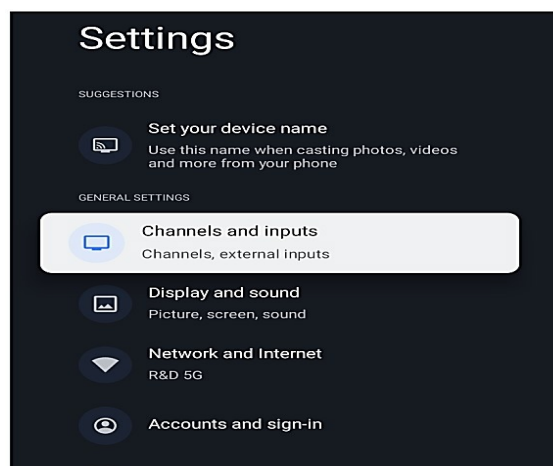

General Settings:

Channels & Inputs:

Adjust the channel settings, scan for channels, and adjust the input settings.

Display and Sound:

Adjust the picture settings and adjust to experience the different sound effects.

Network and Internet:

Configure the Wi-Fi and internet settings. The network status is also displayed.

Accounts & Sign In:

Sign in to your Google account to make the most of your TV. And there are two methods you can choose to sign in. The first one means that you should visit androidtv.com/setup with your phone or computer and then login to your Google account. We recommend selecting the second one that uses your remote to sign in to the TV directly.

Privacy:

You can improve your browsing experience with privacy settings.

Apps:

View the TV guard and the list of recently opened apps, all installed apps, and the system apps. You can also add permissions for different apps, configure special app access to optimize energy, and set usage access, notification access, picture-in-picture mode, and more.

System:

Set the preferences of the Android TV.

Remotes and Accessories:

Search for Bluetooth accessories and pair them with your TV. You can set up your TV to make it visible to all nearby Bluetooth devices.

Help and Feedback:

Visit Google TV Help at go.com/tv.

Channels and Inputs:

The channels and inputs menus are used to scan and maintain your channels and access the Electronic Program Guide. Adjust the input settings. The menus are only available in TV mode.

1. In TV mode, press on the remote control, select Settings and go to Channels and Inputs.
2. Press the Up/Down button to select the item you want to set, and then press OK.
3. Set the channel and input items to your preferences one by one.

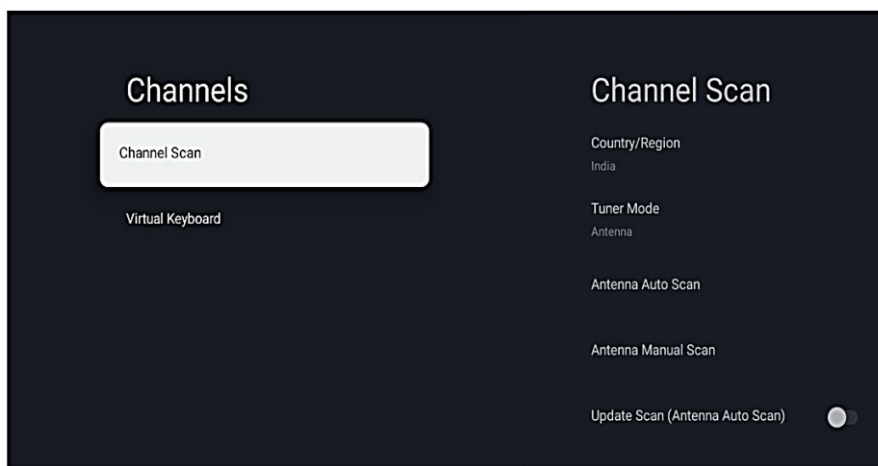

Channels:

Channel Scan:

Search channels automatically or manually.

1. Scan Automatically:

Press the Up/Down button to select Scan Automatically, and press OK to enter. Select the tuner mode and channel type you want, then press the down button to select Search, and press OK to start scanning channels.

2. Manually Scan:

Scan channels manually by entering parameters such as channel number or frequency.

Inputs:

You can see the connected inputs and standby inputs, set their names, and select whether to display them in the input list.

Control Other Devices (CEC): Control the devices connected by HDMI.

Picture and Sound:

The menus are used to obtain the best picture and audio settings according to your preference and the type of program you are watching. The menus can be set up for every broadcast type and every input source.

1. Press on the remote control, select Settings, and go to Picture or Sound.
2. Press the Up/Down button to select the item you want to set, and then press OK.
3. Set the picture and audio items to your preferences one by one.

Note: *The options available may vary depending on the picture mode you set.*

Picture Mode:

Select a picture mode optimized for different viewing conditions. Press the Up/Down button to select an option and then press OK.

Advanced Settings: Adjust more picture options.

Reset to Default: Reset picture settings to the default condition.

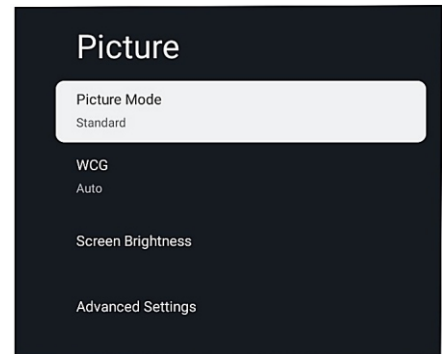

Sound Mode:

Select a sound mode that best suits your audio needs. Enter the Sound Mode menu, press the Up/Down button to select an option, and then press OK.

Balance: Adjust the volume of the left and right speakers.

Sound Surround: Enjoy the sound surround effect.

Reset to default: Reset the sound setting to the default condition.

System Settings:

Follow these instructions to configure various system settings.

1. Press on the remote control to display the TV homepage.
2. Press the Up/Down/Right/Left button to move the cursor to the on-screen screen, and press OK to enter the Settings menu.
3. Press Up/Down to select System, and then press OK.
4. Press Up/Down to select the items you want to set, and then press OK.

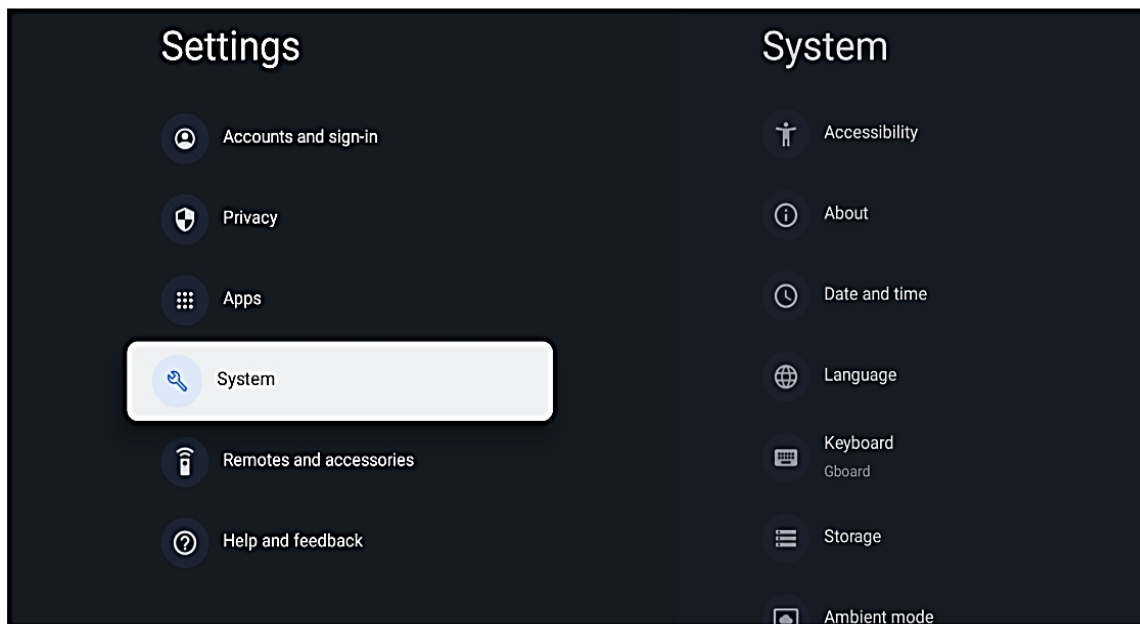

Accessibility:

Configure captions, high-contrast text, and text-to-speech. Set the talkback and switch access.

About:

Check the detailed information of the TV, such as the system update, device name, status, model and version, product information, etc. You can also view legal information, turn on the auto-update, and reset the TV.

Date and Time:

This function needs a network connection, and then you can set the date and time. You can choose whether to auto-synchronize or to manually set the date and time. You can also set the time zone and choose to use a 24-hour format.

Language:

Select a menu language. The selected menu language will also be set as the voice recognition language.

Keyboard:

Configure the settings of the on-screen keyboard. You can set the language and check the version and user agreements of the current keyboard. You can also add new virtual keyboards or an active virtual remote keyboard.

Storage:

View the memory usage status, clear data, cache and defaults, and to open, force stop or disable an app. Besides, you can add or remove an app's permissions to access your contacts, location, microphone, etc.

Ambient mode:

You should set up Google TV to enable the function that can show the weather, time, the owner's name, etc. with Ambient.

Power & Energy:

Configure the screen saver settings, including power on behaviour, the inactivity time after which to turn off the display, the sleep timer. Configure the quick start function and screenless service.

Cast:

You can give permissions to media casting.

System Sounds:

You can set the system sounds to be off or on.

Shop Mode:

You can set the shop mode to off or on.

Restart:

Restart the TV.

Remote & Accessories:

Connect remote controls or other accessories, such as a keyboard, mouse, gamepad, BT speaker, and soundbars, to interact with your smart TV easily.

**NOTE**

In the dry environment due to static electricity, the product may restart and return to the main OSD interface, USB player interface or the previous source mode. It is normal and please continue to operate the TV as you will.

INSTALLING YOUR UHD LED TELEVISION

1. Wallmount Instructions

If you are mounting your TV to the wall, do not attach the TV base stand or TV stand column. To mount your TV to the wall, you will need below:

For 43" UHD TV: Base Plate-200 x 200, 2 M6 x 10mm, ST-10x38mm screws

For 55" UHD TV: Base Plate-200 x 200, 2 M6 x 12mm, 2 M6 x 20mm screws

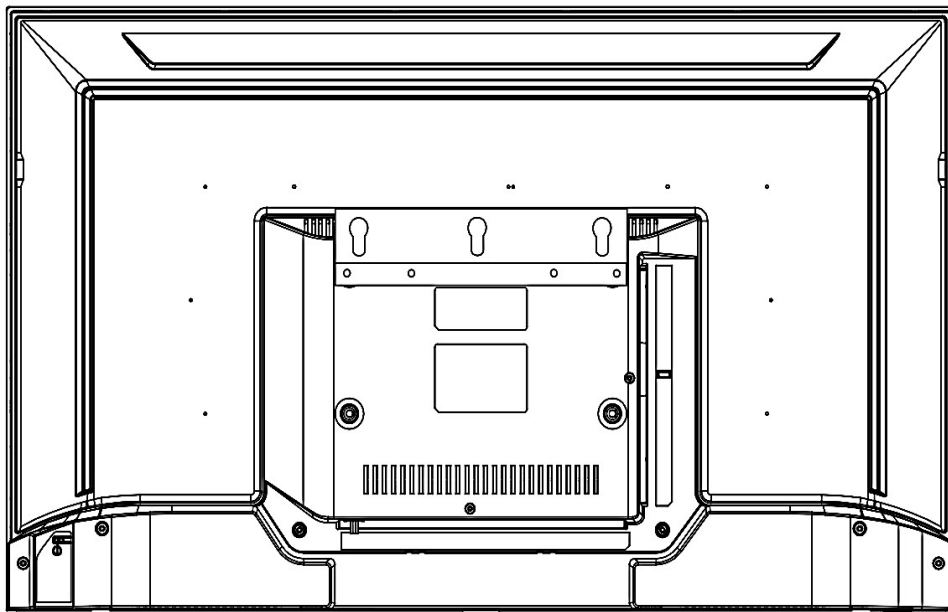















2. To use the stand

- A. To prevent damage to the screen, carefully place your TV on a soft, cushioned surface.
- B. Put the column of the stands into the TV, align the stands with the screw holes located on the TV. Secure the stands to the TV with four (4) screws.

Note: Make sure the installation direction of the stand is the same as illustrated.

Remote Control



Buttons	Function
Power 	Turn On/ Off TV
Source 	Selects a signal source.
Profile 	Access the profile selector
Voice 	Activates voice command function
Settings 	Displays system setting menu
Navigation/Ok	Press the direction buttons to select menu options or settings. Press OK to select or confirm a menu item.
Back 	Returns to previous menu or setting
Home 	Opens the Android TV homepage
TV keys 	Opens the TV source
Volume 	Adjust the volume
Mute 	Mutes or unmutes sound
Channel 	Change Programme
Virtual Key 	Opens Virtual Key
Menu 	Opens Setting Menu
Info 	Opens Settings Menu
NETFLIX	Opens the Netflix app
prime video	Opens the Prime Video app
YouTube	Opens the YouTube app
Disney+ hotstar	Opens the Disney hotstar app

You can pair remote while setup your device, if you did not pair it while setup, then follow the instructions written in remote and accessories to pair your remote.

Pairing the Bluetooth remote control with your TV

For the remote control supplied with your TV, the pairing could be done at the first step of "Initial Setup" or in "Settings."

In Settings, please refer to the following steps to pair the remote control:

1. Press and hold the "Google Assistance Button" to start pairing.
2. If remote control is not pairing, then "In the home page, select Settings > Remotes & Accessories > Pair accessory.
3. You will be shown "Mremote" in the list; select this and pair a remote. (If the remote is not showing up in the list, please reset the remote by long-pressing the HOME and BACK buttons until a green light blinks on the top side of the remote).
4. It will show "Success" after the Bluetooth remote control is paired with the TV successfully.

Install Remote Control Batteries

Place two AAA size batteries in the remote control's battery compartment, making sure to match the polarity markings inside the compartment.

Note: *Please use Alkaline Batteries for Remote*

Flicker Free

Onscreen flicker may cause eye strain, fatigue and headaches after an extended viewing. With "Flicker Free" technology featured in this product, you will have a comfortable viewing experience. No visible and invisible flickers exist within the frequency range of 0~3000Hz, which can be certified when the central luminance is set to be the default value, the minimum value or 30cd/m.

Note: *"Flicker Free" technology may not be supported depending on the region or model.*

INSTRUCTIONS FOR CUSTOMERS

1. You should retain the warranty card / invoice for records and shall compulsorily produce the same in the event of any repairs during the warranty period.
2. In the event of any defect in the product, you are requested to register a complaint by visiting the customer service desk at a nearby Croma store or by connecting to the customer care no. at 1800-572-7662.

Terms & Conditions:

1. All repairs during the warranty period shall be carried out only through service centres authorized by Croma.
2. On acceptance of the claim for repairs made by the customer during the warranty period, Croma may arrange for an employee, agent, or contractor of Croma ("Authorized Repairer") to visit the customer premises where the product is in use or is installed ("Product Location") to assess the warranty claim and, if necessary, carry out any requisite repairs or replacements as the case may be.
3. Croma shall provide the service in accordance with warranty terms only for the products installed within the municipal limits of the store from where they were purchased. If the product is installed outside the municipal limits, then the customer shall be responsible for arranging to bring the product to the store at his own risk and cost.
4. In cases where the product needs to be re-installed and the unmounting from the wall is more than 1.2 m, Croma reserves the right to unmount the same on a chargeable basis. The detailed condition and the applicable charges are annexed at the end of this document, earmarked "Annexure A."
5. For the purpose of this warranty, "warranty period" shall mean the following:
 - a. For television used for non-commercial purposes: a period of Twelve months (12) from the date of purchase, as may be mentioned on the invoice.
 - b. For television used for commercial purposes: a period of Three months (3) from the date of purchase, as may be mentioned on the invoice.
 - c. For accessories received along with the television: a period of Six months (6) from the date of purchase, as may be mentioned on the invoice.

6. While Croma shall take all possible steps to repair or resolve the issue at the earliest, it is expressly stated herein that Croma shall not be under any obligation to provide the resolution within any specified number of days.
7. The warranty provided herein shall exclude the following, and thereby any claim made in respect of defect, damage, or loss attributed to the following reasons shall not be entertained or accepted under the terms of the warranty. The claim shall not be accepted as a rightful case for warranty under the following conditions:
 - Improper setting up, installation, or positioning of the product; improper adjustment of settings and controls as may be associated with the product. For the purpose of this warranty, the term "improper" shall mean and include using the product in any manner other than as mentioned in the user manual.
 - Dismantling, repairing, servicing, or other work carried out on or in relation to the product by any person other than an authorized service provider of Croma. Such an action shall render this warranty void from the date of such action.
 - Use of defective or incompatible parts or accessories with or in relation to the product.
 - Exposure of the product to excessive heat or moisture or other hostile environmental conditions, including damage caused by dust, rodents, insects, rust, corrosion, salt buildup, or inadequate ventilation.
 - Viewing of an image or images on the display screen of the product for an extended period of time, it is hereby stated that permanent damage can be caused to a television if still or repetitive images are left unchanged or used on the screen for an extended period of time. For the purpose of this clause, "extended period of time" shall mean a period of 15 to 20 days.
 - Electrical issues, including power surges, spikes or dips, or incorrect or fluctuating voltage or current;
 - Externally or other interference resulting from or caused by or to other products and/or sources.

- Use of any other equipment, systems, utilities, services, applications, parts or other items not supplied or authorized by Croma;
 - Cosmetic, structural, or mounting items associated with the television, including brackets, wall mounts, shelves, or doors;
 - Consumable (for example, bulbs, globes, batteries, and cables) or lost parts or accessories associated with the television.
 - Normal wear and tear of the television.
 - Accident, theft, vandalism, misuse, abuse, negligence, collision with another object, operation of a computer virus, fire, flood, liquid spillage or ingress, earthquake, thunderstorm activity, acts of God, or any other event or circumstance occurring in relation to the television that is beyond the reasonable control of Croma:
 - Any incompatibility arising during usage with the inverter due to the power-sharing capabilities of the inverter.
 - Issues arising from incompatibility with mobile devices during screen mirroring or screen casting.
8. Without limiting any other provisions of this warranty and to the maximum extent permitted by law, this warranty shall not apply, and Croma will not be liable for any claim made here in relation to the product on the occurrence of any one or more of the following conditions:
- a. The product was not purchased by the customer in India, was not purchased as a brand-new product, or was made through an outlet that, at the time of such purchase, was not authorized to sell the product.
 - b. The serial number on the television has been damaged, modified, or removed.
 - c. Wherein the customer owes any outstanding amount to Croma payable against any services availed previously or against any purchase made through Croma.
 - d. Any hardware or software associated with the product has been accessed, tampered with, or compromised due to any action undertaken by the customer or any third party.
 - e. On account of breach of any terms and conditions as stated under this warranty.

9. Once the claim as raised under this warranty is accepted by Croma, the customer hereby undertakes to adhere to and comply with the following conditions:
 - a. That customer shall comply with the necessary directions as may be given by Croma or its authorized service centers for the due fulfilment of the terms of warranty.
 - b. That the customer acknowledges that a standby unit may or may not be provided while the product is being transported, examined, repaired, or replaced under this warranty.
 - c. That the customer acknowledges that any parts used in the repair of the product (if applicable) may be new or refurbished and may be different from or cost less than the original parts.
 - d. That the customer acknowledges that if any request is made to Croma for arranging the visit to the product location or to any authorized service provider to carry out any repair or to provide any products or parts outside the scope of a warranty claim, Croma shall have the liberty to charge the customer for all such visits, services, and assistance.
 - e. That the customer acknowledges that the terms of warranty and its corresponding benefits are restricted to the original buyer and therefore are non-transferable in nature.
10. If the product in question can access any software application, content, and/or services provided by any third party, whether through the Internet or otherwise, then the disclaimer that appears when you first set up the television and that is also contained as a separate document in the packaging provided with the television shall apply. Below are the application clauses:
 - a. Various OTT platforms and applications available in the App Store may undergo license revisions to the associated launching platforms. Therefore, it might cause a particular app to stop working, and in such cases, their workability will not be warranted.
 - b. Any unlicensed applications used on the TV by the customer are the sole responsibility of the customer, and Croma cannot be responsible for any unlicensed application.

- c. Any unlicensed applications used on the TV by the customer are the sole responsibility of the customer, and Croma cannot be responsible for any unlicensed application.
 - d. Applications available in the GTV portal are licensed for a particular version; this can only be upgraded to a newer version at the sole discretion of the GTV OS.
11. Defective on Arrival (DOA): Any defect/failure related to hardware (panel, motherboard, electronic, and electrical parts) within 14 days from the date of purchase will be replaced with a new one on customer request. Any issues with regards to software, apps, or picture- hanging will be rectified by a software update, and a DOA replacement will not be provided. All defects reported after 14 days from the date of purchase will be fixed with the required repairs, and the product will not be replaced. If the product is approved for replacement, complete packing material with accessories is required.

Zero Dot Warranty Terms and Conditions:

1. This product comes with Twelve months (12) Zero Dot Panel Replacement Warranty.
2. Defective pixels in the television: where the visible number of those defective pixels is less than or equal to the acceptable number of defective pixels mentioned in the manufacturer's specifications (or where there are no such specifications relating to defective pixels for the television, then if there are less than 12 defective pixels), it is hereby acknowledged that a normal limitation of the technology for LCD (and the associated manufacturing processes) is for the screen to exhibit some bright, dark, or partially lit pixels.

ANNEXURE A

If the product that is the subject of the Warranty Claim is positioned higher than 1.2 mm from floor level, is ceiling or wall mounted, was installed using aftermarket mounts and/or stands, or was not installed by Croma Service Center, then Croma may also charge you an additional amount relating to the removal and/or reinstallation of the product. The charges may be applicable as follows:

TV RATE CARD-ACCESSORIES AND ACTIVITY			
Product	Charges borne by	Charges	Remarks
TV Wall Mount installation-within the TV box	NA	FOC	
TV Wall Mount installation-purchased by customer labour charges	Customer	500	
Customer Request-TV Uninstallation (in Warranty Customer) and during installation of Croma TV if old customer TV needs to be uninstalled	Customer	200	
Repairs of PCB-COW Customer	Customer	On Actuals	In addition to the service charges
Repairs of Panel-OOW Customer	Customer	On Actuals	

SAFETY INSTRUCTIONS

General Safety Instructions

- Before using the appliance, check for any damage. If there is any damage, do not use the appliance and immediately contact Croma Customer Care at 1800-572-7662.
- Do not operate the appliance with a damaged power cord/plug or if it has been dropped and damaged in any manner. If the product requires attention within the warranty period, please contact Croma Customer Care at 1800-572-7662.
- To protect against fire, electric shock, or injury, do not place a cord, plug or appliance in water or any other liquid.
- Do not install the product in an area prone to combustible gas leaks, grease, or metal dust.
- This appliance is not intended to be used by people, including children, with reduced physical, sensory, or mental capabilities or a lack of experience and knowledge unless they have been given supervision or instructions concerning the use of the appliance by a person responsible for their safety.
- To protect against electric shock, always unplug from the outlet before cleaning. To disconnect, remove the plug from the outlet. Do not yank on the cord, as it may damage the cord and eventually cause an electric shock.
- To avoid an electrical overload, do not operate another high-wattage appliance on the same power socket.
- The use of accessories/attachments/utilities not approved by the manufacturer may result in improper functioning of the appliance/fire/electric shock/injury.

Product Usage Warning

- Use attachments or accessories supplied with the product only.
- For electrical and safety information, please refer to the rating label on the rear side of the television set.
- Do not expose the television set to rain, moisture, or a humid atmosphere to avoid the risk of fire or electrocution.
- Do not expose the television set to direct sunlight or any other heat-radiating sources such as candles, stoves, etc.
- Do not obstruct any vents provided on the television for ventilation, as this will result in overheating of the product.

- Do not mount the television on any wall that may have seepage issues or below ACs, as this may cause an electrical short circuit and permanent damage to the TV due to moisture.
- Please mount the television set securely to a wall or place it on a stable surface with the base stand attached to the TV set to avoid personal injury or damage to the TV set.
- Do not put any objects, such as pins or any other metal objects, inside the television set, as this may result in permanent damage due to electrical shock.
- Do not put any kind of water container close to the TV set, as this might accidentally result in a water spillage on the TV set.
- Secure the power cord properly with cable ties or cord binders to avoid tripping over loose wires, which may cause the TV to move or fall from its original position.
- Do not mix old and new batteries to avoid explosions.
- Ensure correct polarity while inserting batteries in the remote control.
- Old batteries may leak and damage the remote control. Always remove batteries as soon as they become weak or in case the remote is not going to be used for a long time.
- For best performance, the batteries should be replaced on a yearly basis or when remote operation becomes erratic.
- For proper functioning of the remote, remove any obstacle between the TV and the remote-control unit.
- Do not keep any source of naked flames, such as candles, adjacent to the TV; this may result in a hazardous situation.
- During thunderstorms and heavy rains, please disconnect the power supply and remove the antenna plug.
- Ensure proper grounding before plugging the TV into an electrical power socket.
- Ensure that the plug and socket are tightly fitted and do not have any loose contacts, as this might result in an electrical spark and permanent damage to the product.



- *Turn off the appliance and disconnect the power if you are not going to use it for a long time.*
- *Turn off and unplug the unit during storms.*
- *Do not operate the appliance with wet hands.*
- *Do not use the device for any purpose other than the intended use.*

REGULATIONS AND LICENSE

E-Waste Management Policy



This symbol on the product and/or accompanying documents means that the used electrical and electronic products should not be mixed with general household waste.

For proper treatment, recoveries, recycling, etc., this product needs to be taken to the designated collection points, where it will be accepted on a free-of-charge basis.

Alternatively, the user may be able to return the product to the Croma Store on the purchase of a new product. Disposing of this product correctly will help save valuable resources and prevent any potential negative effect on human health and the environment, which could otherwise arise from inappropriate waste handling.

Please contact Croma Customer Care at 1800-572-7662 for further details on your nearest designated collection point. As per the Indian Legislation, penalties may be applicable for incorrect disposal of waste.

Product Packaging

Product packaging has the purpose of protecting an appliance from damage that might occur during transportation. The materials used for packaging are recyclable and are selected because of respect for the environment and ease of disposal, with the aim of material reintegration into the product production cycles. This mechanism not only allows the reduction of the volume of waste but also makes a more rational usage of non-renewable resources possible.

Important Instructions

- Read this manual and the warranty card carefully before operating your product. Retain this manual for future reference.
- Follow all instructions and explanations while handling and installing your product. Keep the manual handy for later use.
- All the information in this manual is based on the latest product information available at the time of printing of this manual. However, due to improvements or other changes, there may be discrepancies between the information in this manual and the actual product.
- While due precautions are taken in printing this manual, Infiniti Retail Limited assumes no responsibility for any errors or omissions.

BEE Attention

This product is qualified for the BEE Star rating in the 'ECO' Mode. The objectives of the Star Labelling Program are designed to promote energy-efficient products and practices.

When the television is initially set up, it is designed to meet the BEE Star Labelling requirements while maintaining optimum picture quality.

- Changes to certain functionalities of this television (TV guide, picture/sound, etc.) may change the power consumption.
- Depending on such a changed setting (e.g., retail mode), the power consumption may vary, which could possibly exceed the stated energy consumption.

To reset the television to a star rating in qualified settings, select 'ECO' mode from the initial set-up procedure in 'factory setting' under the 'Set-up' menu.

License

1. Google TV is the name of this device's software experience and a trademark of Google LLC. Google, YouTube, and Chromecast built-in and other related marks are trademarks of Google LLC.



2. The Adopted Trademarks HDMI, HDMI High-Definition Multimedia Interface, and the HDMI Logo are trademarks or registered trademarks of HDMI Licensing Administrator, Inc. in the United States and other countries.



3. Dolby, and the double-D symbol are registered trademarks of Dolby Laboratories Licensing Corporation. Manufactured under license from Dolby Laboratories. Confidential, unpublished works. Copyright© 2012-2022 Dolby Laboratories. All rights reserved.



WARRANTY CARD

Product Name : Croma UHD LED TV

Model Name	Model Number
43" UHD LED TV	CREL043UGC0333801
55" UHD LED TV	CREL055UGC0333801

- This warranty is applicable on this product for a period of Twelve (12) months from the date of purchase.
- In case of commercial usage of this product, the warranty period would be limited to 90 days only.
- This warranty will be terminated automatically after 12 months from the date of purchase, even if the product was not in use during the warranty period for any reason.

Infiniti Retail Limited, ("IRL") guarantees the product purchased to be free from defects resulting from the use of faulty parts or poor workmanship during its manufacture, subject to terms of the limited warranty ("Warranty").

These warranty instructions are detailed on our website and can be accessed through the link -

<https://www.croma.com/lp-warranty-on-croma-exclusive>

If you experience any difficulty in operating this product or require any service assistance, please contact the undersigned contact.

**Croma Customer Care,
Infiniti Retail Limited, Unit No. 701 and 702, 7th Floor, Kaledonia,
Sahar Road, Andheri (East), Mumbai - 400069, India.
Customer Care Number: 1800-572-7662
E-Mail: customersupport@croma.com**