

# User Guide

---

## HW-Q930D / HW-Q800D / HW-Q700D

To receive more complete service, please register your product at [www.samsung.com/register](http://www.samsung.com/register)

Figures and illustrations in this User Guide are provided for reference only and may differ from actual product appearance.

# CONTENTS

<b>01</b>	<b>Checking the Components</b>	<b>3</b>	<b>08</b>	<b>Installing the Wall Mount</b>	<b>28</b>
				Installation Precautions .....	28
<b>02</b>	<b>Product Overview</b>	<b>4</b>		Wallmount Components .....	28
	Top Panel of the Soundbar .....	4		Installing the Surround Speakers on a Wall (applicable models only) .....	29
	Bottom Panel of the Soundbar .....	5	<b>09</b>	<b>Installing the Soundbar in front of TV</b>	<b>29</b>
<b>03</b>	<b>Using the Soundbar Remote Control</b>	<b>6</b>		Component .....	29
	Inserting Batteries before using the Remote Control (AAA batteries X 2) .....	6	<b>10</b>	<b>Software Update</b>	<b>30</b>
	How to Use the Remote Control .....	6		Auto Update .....	30
	Setting the  (Sound Control) .....	7		USB Update .....	30
	Using the Hidden Buttons (Buttons with more than one function) .....	8		Security updates information .....	30
	Output specifications for the different sound effect modes .....	8		Initialization .....	31
	Adjusting the Soundbar volume with a TV remote control .....	10	<b>11</b>	<b>Troubleshooting</b>	<b>31</b>
<b>04</b>	<b>Connecting the Soundbar</b>	<b>11</b>	<b>12</b>	<b>Licence</b>	<b>33</b>
	Connecting the power and units .....	11			
	– Recommended Speaker Layout .....	12			
	– Surround speaker mode (HW-Q930D only) .....	12			
	– Manually connecting the Subwoofer or Surround Speakers .....	13			
	– LED Indicator Lights on the Rear of Subwoofer and Surround Speakers .....	14			
<b>05</b>	<b>Connecting to a TV</b>	<b>15</b>			
	Connecting the TV that supports HDMI ARC (Audio Return Channel) .....	15			
	Connecting using an Optical Cable .....	16			
	Connecting via Bluetooth .....	17			
	Connecting via Wi-Fi .....	19			
	Using the Q-Symphony Function .....	20			
	Using the SpaceFit Sound .....	21			
<b>06</b>	<b>Connecting an External Device</b>	<b>22</b>			
	Method 1. Connecting using an HDMI Cable (Capable of Dolby Atmos / DTS:X decoding and playback) .....	22			
	Method 2. Connecting using an Optical Cable .....	23			
<b>07</b>	<b>Connecting a Mobile Device</b>	<b>24</b>			
	Method 1. Connecting via Bluetooth .....	24			
	Method 2. Connecting via Wi-Fi (Wireless Network) .....	26			
	Using Group Play .....	26			
	Connecting via Apple AirPlay .....	27			
	Using the Tap Sound .....	27			

# 01 CHECKING THE COMPONENTS

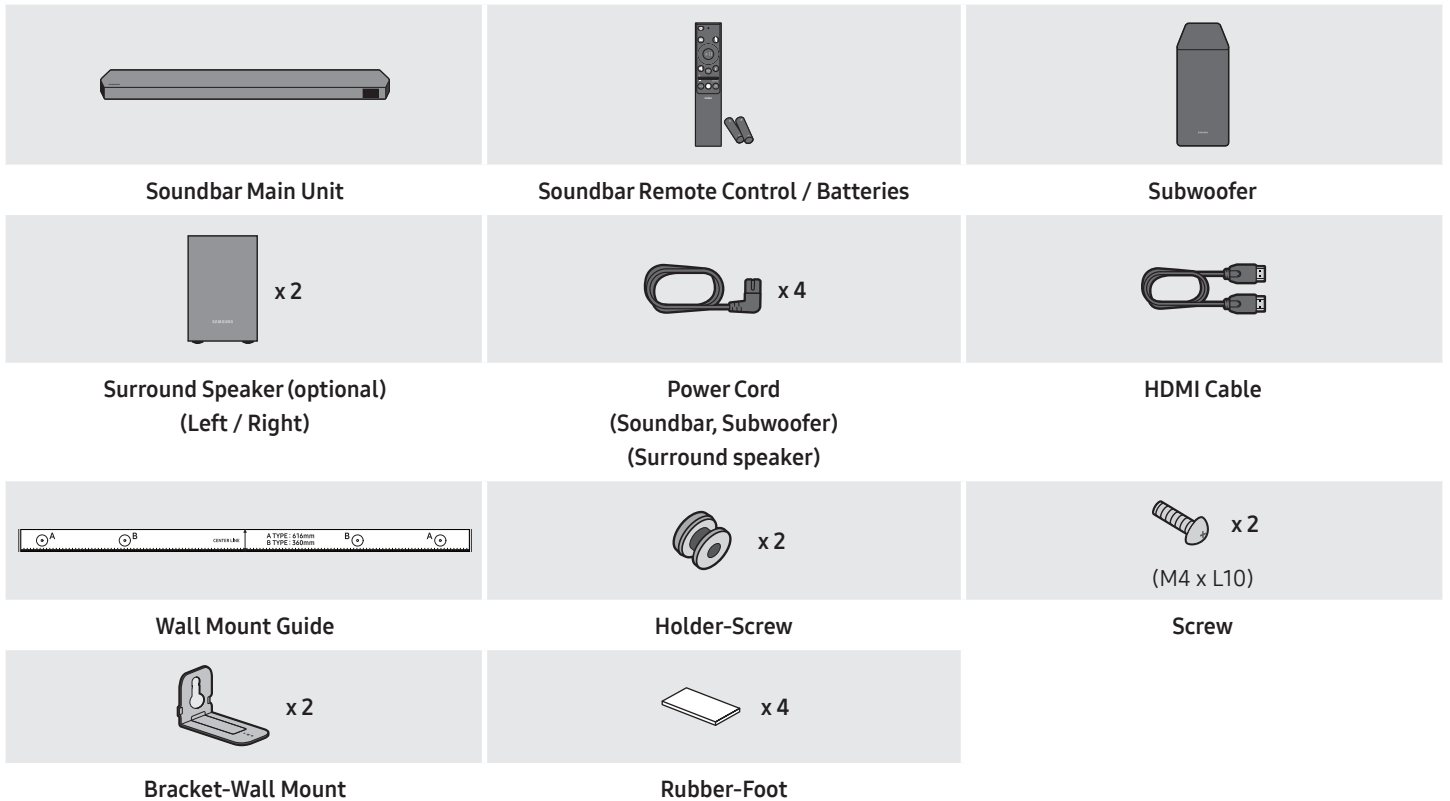

- For more information about the power supply and power consumption, refer to the label attached to the product. (Label: Rear of the Soundbar Main Unit)
- To purchase additional components or optional cables, contact a Samsung Service Center or Samsung Customer Care.
- For more information about the wallmount or rubber-foot, see pages 28~30.
- Design, specifications, and App screen are subject to change without prior notice.
- The appearance of the accessories may differ slightly from the illustrations above.
- Samsung Electronics Co., Ltd reserves the right to change the specifications without notice.
- Weight and dimensions are approximate.

# 02 PRODUCT OVERVIEW

## Top Panel of the Soundbar

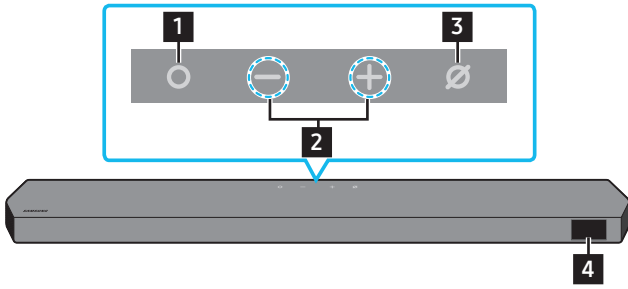

HW-Q930D / HW-Q800D

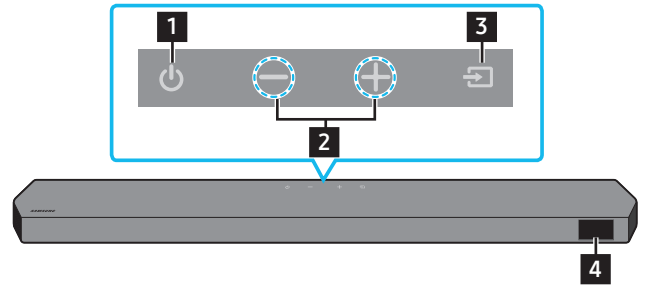

HW-Q700D

1	<p><b>○ (Multi Function) Button (HW-Q930D / HW-Q800D models)</b></p> <ul style="list-style-type: none"> <li>In standby mode, press the <b>○ (Multi Function)</b> button to turn on the Soundbar.</li> <li>Press the <b>○ (Multi Function)</b> button to change the input source.</li> </ul>
1	<p><b>⏻ (Power) Button (HW-Q700D model)</b></p> <p>Turns the power on and off.</p>
2	<p><b>− + (Volume) Button</b></p> <p>Adjusts the volume.</p>
3	<p><b>⊘ (Mic On/Off) Button (HW-Q930D / HW-Q800D models)</b></p> <p>Press the button to turn the microphone on or off. When the microphone is off, the LED indicator will glow red.</p> <div data-bbox="833 918 1508 1064" style="display: inline-block; vertical-align: middle;"> </div>
3	<p><b>⇒ (Source) Button (HW-Q700D model)</b></p> <p>Press the <b>⇒ (Source)</b> button to change the input source.</p>
4	<p><b>Display</b></p> <p>Displays the product's status and current mode. TV ARC or eARC → HDMI → Wi-Fi → BT → D.IN</p>

- When you plug in the power cord, the power button will begin working in 4 to 6 seconds.
- When you turn on this unit, there will be a 4 to 5 second delay before it produces sound.
- If you hear sounds from both the TV and Soundbar, go to the **Settings** menu for the TV audio and change the TV speaker to **External Speaker**.

## Bottom Panel of the Soundbar

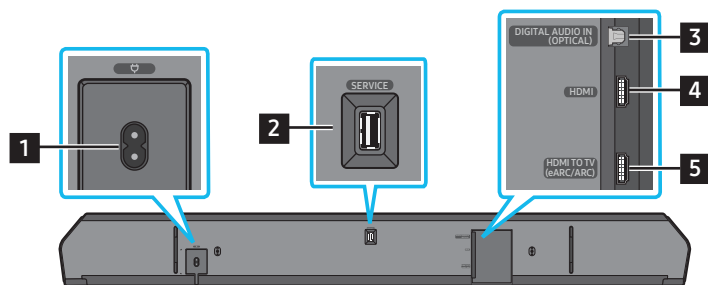

<b>1</b>	<b>POWER</b> Connect the Soundbar's power cord. (See page 11)
<b>2</b>	<b>SERVICE</b> Connect a USB storage device to upgrade the product's software.
<b>3</b>	<b>DIGITAL AUDIO IN (OPTICAL)</b> Connect to the digital (optical) output of an external device. (See page 23)
<b>4</b>	<b>HDMI</b> Inputs digital video and audio signals simultaneously using an HDMI cable. Connect to the HDMI output of an external device. (See page 22)
<b>5</b>	<b>HDMI TO TV (eARC/ARC)</b> Connect to the HDMI jack on a TV. (See page 15)

- When disconnecting the power cord from a wall outlet, pull the plug. Do not pull the cable.
- Do not connect this unit or other components to an AC outlet until all connections between components are complete.

# 03 USING THE SOUNDBAR REMOTE CONTROL





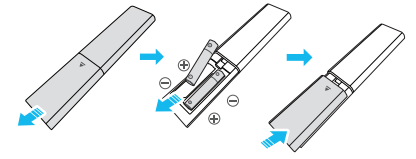





## Inserting Batteries before using the Remote Control (AAA batteries X 2)









Slide the back cover in the direction of the arrow until it is completely removed. Insert 2 AAA batteries (1.5V) oriented so that their polarity is correct. Slide the battery cover back into position.

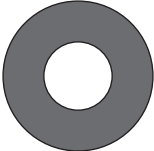

## How to Use the Remote Control

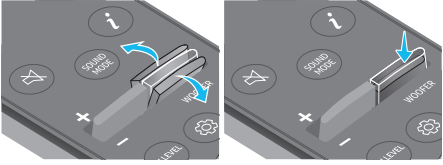

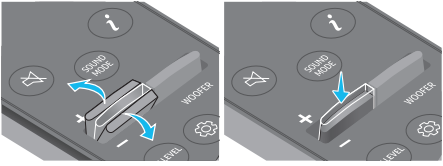
 <b>Power</b>	<p>Turns the Soundbar on and off.</p> <ul style="list-style-type: none"> <li><b>Auto Power Down Function</b> The unit turns off automatically in the following situations: <ul style="list-style-type: none"> <li>In <b>TV ARC</b> or <b>eARC</b>, <b>HDMI</b>, <b>Wi-Fi</b>, <b>BT</b>, <b>D.IN</b> mode if there is no audio signal for 18 minutes.</li> </ul> </li> </ul>
 <b>Source</b>	<p>Press to select a source connected to the Soundbar.</p> <ul style="list-style-type: none"> <li><b>Voice Feedback On/Off</b> You can turn on or off the <b>Voice Feedback</b>. Press and hold the  (<b>Source</b>) button on the remote control for 5 seconds while the Soundbar is off (Standby mode). Each time you change the <b>Voice Feedback</b> setting, the display will show "<b>AUI OFF</b>" (Default) or "<b>AUI ON</b>".</li> </ul>
 <b>Bluetooth PAIR</b>	<p>Switch the Soundbar to Bluetooth pairing mode. Press the button and wait for the "<b>BT PAIRING</b>" screen to connect to a new Bluetooth device.</p>
 <b>Mute</b>	<p>Press the  (<b>Mute</b>) button to mute the sound. Press it again to unmute the sound.</p>
 <b>SOUND MODE</b>	<p>By pressing the button, you can select the desired audio mode such as <b>Surround</b>, <b>Game Pro</b>, <b>Standard</b>, <b>Adaptive Sound</b>.</p> <ul style="list-style-type: none"> <li><b>Standard</b> Outputs the original sound.</li> <li><b>Surround</b> Provides a wider sound field than standard.</li> <li><b>Game Pro</b> Provides stereoscopic sound to immerse you in the action while gaming.</li> <li><b>Adaptive Sound</b> Analyzes the content in real time and automatically provides the optimal sound field based on the characteristics of the content.</li> </ul>
 <b>CH LEVEL</b>	<p>By pressing the button, you can adjust the volume of the each speaker such as <b>Center level</b>, <b>Side level</b>, <b>Wide level</b>, <b>Front Top level</b>, <b>Rear level</b>, and <b>Rear top level</b>.</p> <ul style="list-style-type: none"> <li>To control the volume of the each speaker select <b>Center level</b>, <b>Side level</b>, <b>Wide level</b>, or <b>Front Top level</b> in Sound Settings, and then adjust the volume between -6~+6 by using the <b>Up/Down</b> buttons.</li> <li>If Surround Speakers are connected, select <b>Rear level</b> or <b>Rear top level</b> and then use the <b>Up/Down</b> buttons to adjust the volume within a -6 to +6 range.</li> <li><b>CH LEVEL</b> specifications may differ with the respective model.</li> </ul>
 <b>Sound Control</b>	<p>By pressing the button, you can set the audio functions such as <b>SpaceFit Sound</b>, <b>AVA</b>, <b>Voice enhance mode</b>, <b>Night mode</b>, <b>Sync</b>, <b>Surround speaker mode</b>, <b>Virtual</b>, <b>Private Rear Sound</b>, and <b>Sound Grouping</b>. The desired item can be adjusted using the <b>Up/Down</b> buttons.</p> <ul style="list-style-type: none"> <li>Refer to "<b>Setting the  (Sound Control)</b>" on page 7.</li> </ul>
 <b>Play / Pause</b>	<p>You can also play or pause music by pressing the button.</p>



 <p>Up/Down/Left/Right</p>	 <p>Press the indicated areas to select Up/Down/Left/Right.</p> <p>Press Up/Down/Left/Right on the button to select or set functions.</p> <ul style="list-style-type: none"> <li>• <b>Music Skip</b> Press the <b>Right</b> button to select the next music file. Press the <b>Left</b> button to select the previous music file.</li> <li>• <b>ID SET</b> Use this option when the Subwoofer or Surround Speakers are not connected or need reconnection. While powered off, press and hold the <b>Up</b> button for 5 seconds to perform <b>ID SET</b>. (See page 13.)</li> </ul>
 <p>Info</p>	<p>Press to display information about the active function or the codec available.</p> <p>In <b>BT</b> mode, it displays the connected device (when pairing is complete) or "<b>BT ready</b>" (when pairing is required).</p>
 <p>WOOFER LEVEL</p>	 <p>Push the button up or down to adjust the level of the woofer (bass).</p>
 <p>VOLUME</p>	 <p>Push the button up or down to adjust the volume.</p> <ul style="list-style-type: none"> <li>• <b>Mute</b> Press the <b>VOL</b> button to mute the sound. Press it again to unmute the sound.</li> </ul>
 <p>TONE CONTROL</p>	<p>By pressing the button, you can adjust the volume of the treble or bass sound. The defined item can be adjusted using the <b>Up/Down</b> buttons. This function is enabled in Sound mode excluding in <b>Standard</b> mode.</p> <ul style="list-style-type: none"> <li>• To control the volume of the treble or bass sound, select <b>TREBLE</b> or <b>BASS</b> in Sound Settings, and then adjust the volume between -6~+6 by using the <b>Up/Down</b> buttons.</li> <li>• Once the bass level is changed, the woofer level will be also adjusted accordingly.</li> </ul>

## Setting the (Sound Control)

- **Active Voice Amplifier (AVA)** : Analyzes external noise in real time while soundbar is playing, so that voice audio can always be heard clearly. No data is saved during the analysis.
- The **SpaceFit Sound** and **AVA** functions are not supported by **HW-Q700D** model.
- **Voice enhance mode** enhances spoken dialog in movies and TV to make it easier to hear.
- **Night mode** is optimized for night time with the settings adjusted to bring the volume down but keep the dialog clear.
- **Sound Grouping** : The Soundbar main unit and the Surround Speakers play the entire sound instead of surround sound, making it ideal for large groups of people listening to music in a large space.
  - This menu is initially activated when the Surround Speakers are connected, and then the menu remains activated regardless of the connection of the Surround Speakers.
  - If you enable the Sound Grouping, there are no differences in sounds between the Sound modes.
  - Sound does not come out from all speaker units of the Soundbar main unit and the Surround speakers, but only from certain predetermined units, which vary by model.
- **Private Rear Sound** : This mode sets the sound to come out from the Surround Speakers only, allowing you to listen without being disturbed by others.
  - If you enable this mode, sound does not come out from the Soundbar main unit and the Subwoofer. Sound only comes out from the front channel of the Surround Speakers.
  - If you enable the Private Rear Sound, there are no differences in sounds between the Sound modes.
  - The function turns off when the power turns off or the Surround Speakers connection is lost.

- The menu is activated only when the Surround Speakers are connected.
- This mode is automatically turned off and becomes unavailable when the **Q-symphony** function turns on.
- Press and hold the  (**Sound Control**) button for about 5 seconds to adjust the sound for each frequency band. 150Hz, 300Hz, 600Hz, 1.2kHz, 2.5kHz, 5kHz, and 10kHz are selectable using the **Left/Right** buttons and each can be adjusted to a setting between -6 to +6 using the **Up/Down** buttons.  
(Make sure the Sound mode is set to “**Standard**”.)
- If the video on the TV and audio from the Soundbar are not synchronized, select **Sync** in Sound Control, and then set the audio delay between 0~300 milliseconds by using the **Up/Down** buttons.
- **Sync** is only supported for some functions.
- Available **Surround speaker mode** settings are supported only by **HW-Q930D** model.
- The **Virtual Speaker** function can be turned **ON/OFF** by using the **Up/Down** buttons.

## Using the Hidden Buttons (Buttons with more than one function)

Hidden Button		Reference page
Remote Control Button	Function	
WOOFER (Up)	TV remote control On/Off (Standby)	page 10
Up	ID SET	page 13
 (Sound Control)	7 Band EQ	page 7
 (Source)	Voice Feedback On/Off (Standby)	page 6

## Output specifications for the different sound effect modes

<HW-Q930D>

Effect	Input	Output
		With Subwoofer & Surround Speaker
Standard	2.0 ch	2.1 ch
	5.1 ch	5.1 ch / 7.1 ch (DTS)
	7.1 ch	7.1 ch
	Dolby Atmos®, DTS:X	7.1.4 ch
Surround	2.0 ch	9.1.4 ch
	5.1 ch	9.1.4 ch
	7.1 ch	9.1.4 ch
	Dolby Atmos®, DTS:X	9.1.4 ch
Game Pro	2.0 ch	9.1.4 ch
	5.1 ch	9.1.4 ch
	7.1 ch	9.1.4 ch
	Dolby Atmos®, DTS:X	9.1.4 ch
Adaptive Sound	2.0 ch	9.1.4 ch
	5.1 ch	9.1.4 ch
	7.1 ch	9.1.4 ch
	Dolby Atmos®, DTS:X	9.1.4 ch



<HW-Q800D>

Effect	Input	Output	
		With Subwoofer Only	With Subwoofer & Surround Speaker
Standard	2.0 ch	2.1 ch	2.1 ch
	5.1 ch	5.1 ch	5.1 ch / 7.1 ch (DTS)
	7.1 ch	5.1 ch	7.1 ch
	Dolby Atmos®, DTS:X	5.1.2 ch	7.1.4 ch
Surround	2.0 ch	5.1.2 ch	7.1.4 ch
	5.1 ch	5.1.2 ch	7.1.4 ch
	7.1 ch	5.1.2 ch	7.1.4 ch
	Dolby Atmos®, DTS:X	5.1.2 ch	7.1.4 ch
Game Pro	2.0 ch	5.1.2 ch	7.1.4 ch
	5.1 ch	5.1.2 ch	7.1.4 ch
	7.1 ch	5.1.2 ch	7.1.4 ch
	Dolby Atmos®, DTS:X	5.1.2 ch	7.1.4 ch
Adaptive Sound	2.0 ch	5.1.2 ch	7.1.4 ch
	5.1 ch	5.1.2 ch	7.1.4 ch
	7.1 ch	5.1.2 ch	7.1.4 ch
	Dolby Atmos®, DTS:X	5.1.2 ch	7.1.4 ch

<HW-Q700D>

Effect	Input	Output	
		With Subwoofer Only	With Subwoofer & Surround Speaker
Standard	2.0 ch	2.1 ch	2.1 ch
	5.1 ch	3.1 ch	5.1 ch
	Dolby Atmos®, DTS:X	3.1.2 ch	5.1.4 ch
Surround	2.0 ch	3.1.2 ch	5.1.4 ch
	5.1 ch	3.1.2 ch	5.1.4 ch
	Dolby Atmos®, DTS:X	3.1.2 ch	5.1.4 ch
Game Pro	2.0 ch	3.1.2 ch	5.1.4 ch
	5.1 ch	3.1.2 ch	5.1.4 ch
	Dolby Atmos®, DTS:X	3.1.2 ch	5.1.4 ch
Adaptive Sound	2.0 ch	3.1.2 ch	5.1.4 ch
	5.1 ch	3.1.2 ch	5.1.4 ch
	Dolby Atmos®, DTS:X	3.1.2 ch	5.1.4 ch

The Surround Speakers will not produce sounds for 2 channel output while **Standard** mode is in use. To enable sound for the Surround Speakers, change the effect mode to **Surround**.

## Adjusting the Soundbar volume with a TV remote control





Adjust the Soundbar volume using the TV's remote control.

- This function can be used with IR remote controls only. Bluetooth remote controls (remote controls that require pairing) are not supported.
- Set the TV speaker to **External Speaker** to use this function.
- Manufacturers supporting this function:  
Samsung, VIZIO, LG, Sony, Sharp, PHILIPS, PANASONIC, TOSHIBA, Hisense, RCA

1. Turn Off the Soundbar.

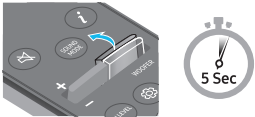
2. Push up and hold the **WOOFER** button for 5 seconds.

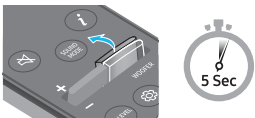
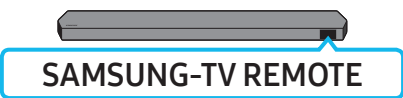
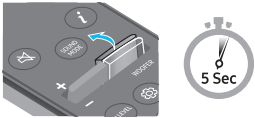
Each time you push the **WOOFER** button up and hold it for 5 seconds, the mode switches in the following order: "OFF-TV REMOTE" (Default mode), "SAMSUNG-TV REMOTE", "ALL-TV REMOTE".

Remote Control Button	Display	Status
	(Default mode) 	Disable the TV remote control.
		Enable a Samsung TV's IR remote control.
		Enable a third-party TV's IR remote control.

# 04 CONNECTING THE SOUNDBAR

## Connecting the power and units

Use the Power cord to connect the Subwoofer, Surround Speakers, and Soundbar to an electrical outlet in the following order:

- For more information about the required electrical power and power consumption, refer to the label attached to the product. (Label: Rear of the Soundbar Main Unit)

1. Connect the Power cord to the Subwoofer.

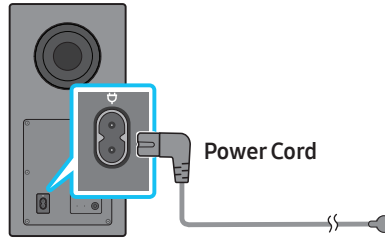

Rear of Subwoofer

2. Connect the power cord to the Left and Right Surround Speakers. (optional)

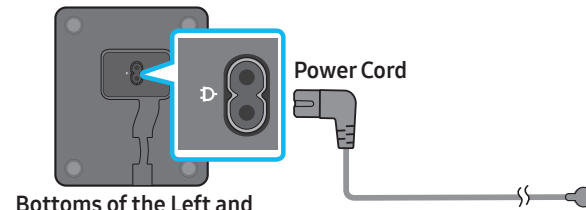

Bottoms of the Left and Right Surround Speakers (optional)

3. Connect the Power cord to the Soundbar.

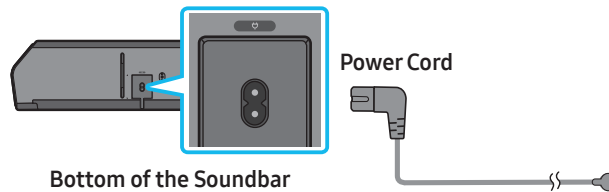

Bottom of the Soundbar Main Unit

4. Connect power to the Soundbar, Subwoofer and Surround Speakers. The Subwoofer and Surround Speakers are automatically connected when the Soundbar is turned on.

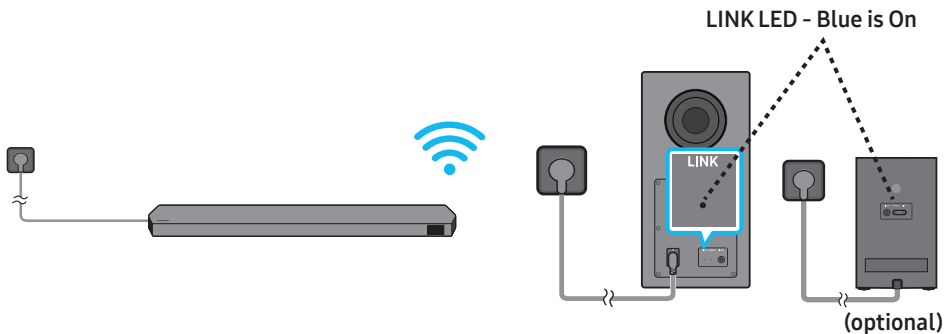

### NOTE

- Connect the Subwoofer and Surround Speakers power before connecting to the Soundbar. The Subwoofer and Surround Speakers will be automatically connected when turning on the Soundbar.
- If you unplug and reconnect the power cord when the product is turned on, the Soundbar turns on automatically.
- The surround speaker system is supported by applicable models only.

## Recommended Speaker Layout

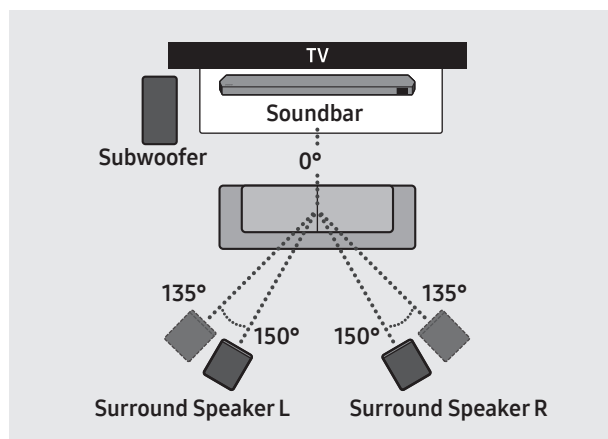

### ⚠ CAUTION

- Wireless receiving antennas are built into the Subwoofer and surround speakers. Keep the units away from water and moisture.
- For optimal listening performance, make sure that the areas around the Subwoofer and surround speakers locations are clear of any obstructions.

## Surround speaker mode (HW-Q930D only)

An optimal surround sound may be delivered depending on the position of the surround speaker. See the illustration below for speaker positioning.

To activate this mode, select the Surround Speaker mode using the remote control of the Soundbar.

(⚙ Sound Control) → Surround speaker → ▲ (Up) / ▼ (Down) → Front / Rear

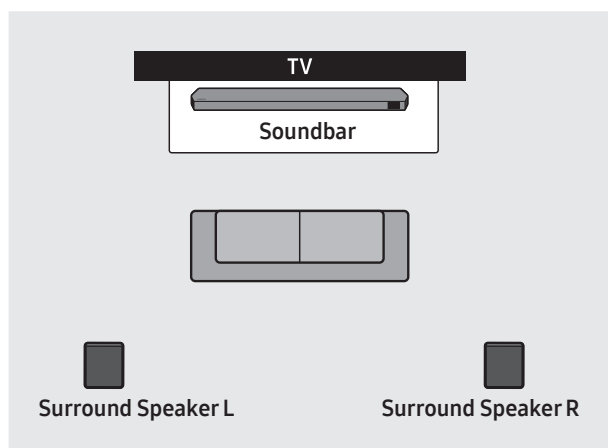

Rear positioning

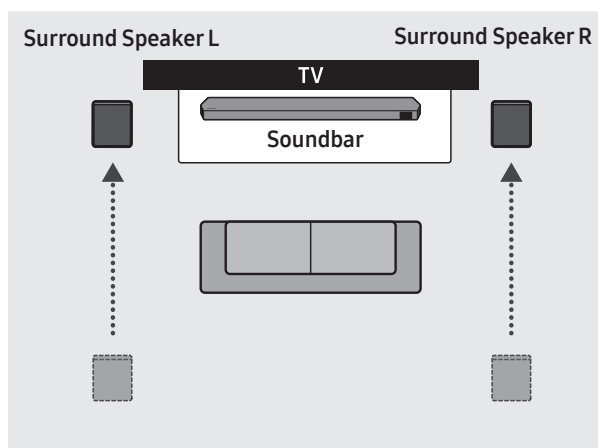

Front positioning

### NOTE

- This mode is available only with Soundbar models including a specific surround speaker.
- In Front speaker mode, position the front speakers toward you.
- The surround speaker mode is enabled by default as rear position.

## Manually connecting the Subwoofer or Surround Speakers

Before performing the manual connection procedure below:

- Check whether the power cables for the Soundbar and Subwoofer or Surround Speakers are connected properly.
- Make sure that the Soundbar is turned off.

1. Turn off the Soundbar main.
2. Press and hold **ID SET** on the rear of the Subwoofer and surround speakers for at least 5 seconds.
  - The red indicator at the rear of each speaker turns off and the blue indicator blinks.

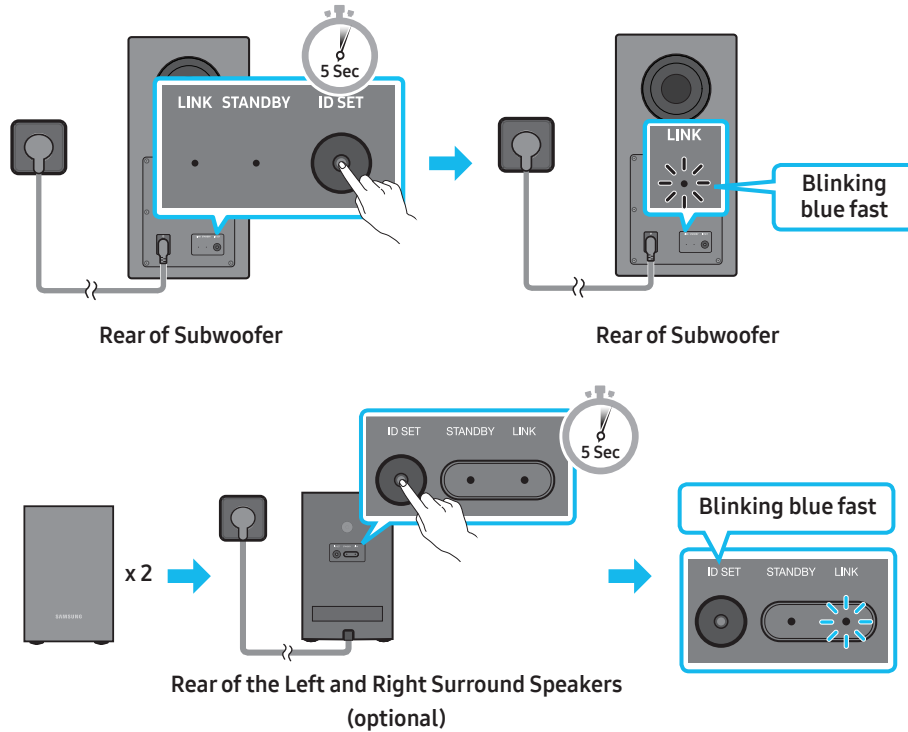

3. Press the **Up** button on the remote control for 5 seconds.
  - The **ID SET** message appears on the display of the Soundbar for a moment, and then it disappears.
  - The Soundbar will automatically power on when **ID SET** is complete.

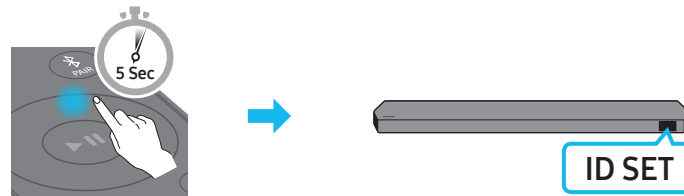

4. Check if the **LINK LED** is solid blue (connection complete).

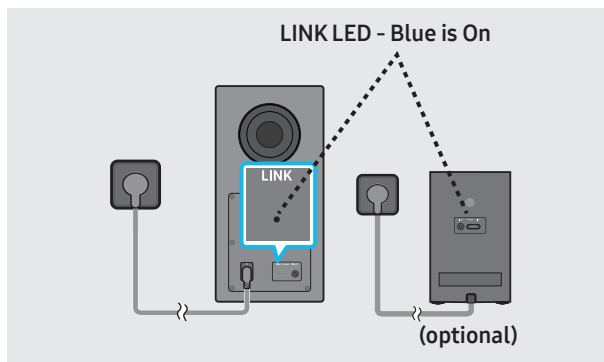

The **LINK LED** indicator stops blinking and glows a solid blue when a connection is established between the Soundbar and the Subwoofer, surround speakers.

### NOTE

- How to Tx Module Reset
1. Turn off the soundbar.
  2. Press the Left button on the remote control for 5 seconds
  3. Follow the "Manually connecting the Subwoofer or Surround Speakers".

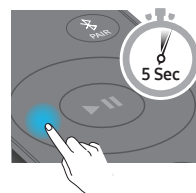

## LED Indicator Lights on the Rear of Subwoofer and Surround Speakers

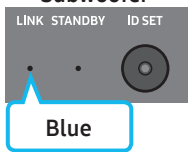
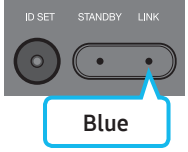
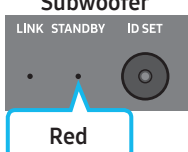
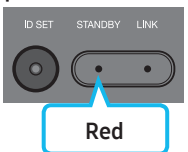
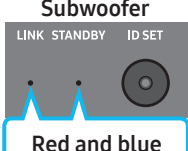
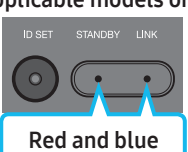
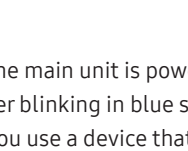
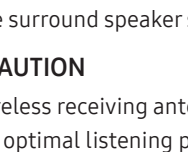
LED	Status	Description	Resolution
<p><b>Subwoofer</b></p>  <p><b>Blue</b></p> <p><b>Surround Speakers (applicable models only)</b></p>  <p><b>Blue</b></p>	On	Successfully connected (normal operation)	-
<p><b>Subwoofer</b></p>  <p><b>Blue</b></p> <p><b>Surround Speakers (applicable models only)</b></p>  <p><b>Blue</b></p>	Blinking	Recovering the connection	Check if the power cable attached to the main Soundbar unit is connected properly or wait about 5 minutes. If blinking persists, try manually connecting the Subwoofer and Surround Speakers. See page 13.
<p><b>Subwoofer</b></p>  <p><b>Red</b></p> <p><b>Surround Speakers (applicable models only)</b></p>  <p><b>Red</b></p>	On	Standby (with the Soundbar main unit turned off)  Connection failed	Check if the power cable attached to the main Soundbar unit is connected properly.  Connect again. See the instructions for manual connection on page 13.
<p><b>Subwoofer</b></p>  <p><b>Red and blue</b></p> <p><b>Surround Speakers (applicable models only)</b></p>  <p><b>Red and blue</b></p>	Blinking	Malfunction	See the contact information for the Samsung Service Center in this manual.

### NOTE

- If the main unit is powered off, the Subwoofer will go into stand-by mode and the STANDBY LED on the rear of the sub-woofer will turn red after blinking in blue several times.
- If you use a device that uses the same frequency as the Soundbar near the Soundbar, interference may cause some sound interruption.
- The maximum transmission distance of the main unit's wireless signal is about 10 m, but may vary depending on your operating environment. If a steel-concrete or metallic wall is between the main unit and the Subwoofer, the system may not operate at all because the wireless signal cannot penetrate metal.
- The surround speaker system is supported by applicable models only.

### ⚠ CAUTION

- Wireless receiving antennas are built into the Subwoofer and Surround Speakers. Keep the unit away from water and moisture.
- For optimal listening performance, make sure that the area around the Subwoofer and the Surround Speakers are clear of any obstructions.
- Do not insert any part of your body or foreign objects into the Subwoofer's duct (hole).
- Do not use the Subwoofer's duct (hole) to hang it on the wall.

# 05 CONNECTING TO A TV

## Connecting the TV that supports HDMI ARC (Audio Return Channel)

### ⚠ CAUTION

- When both the HDMI cable and optical cable are connected, the HDMI signal is received first.
- To connect the HDMI cable between the TV and Soundbar, be sure to connect the terminals marked ARC. Otherwise, the TV sound may not be output.
- The recommended cable is an HDMI cable certified by HDMI.org.

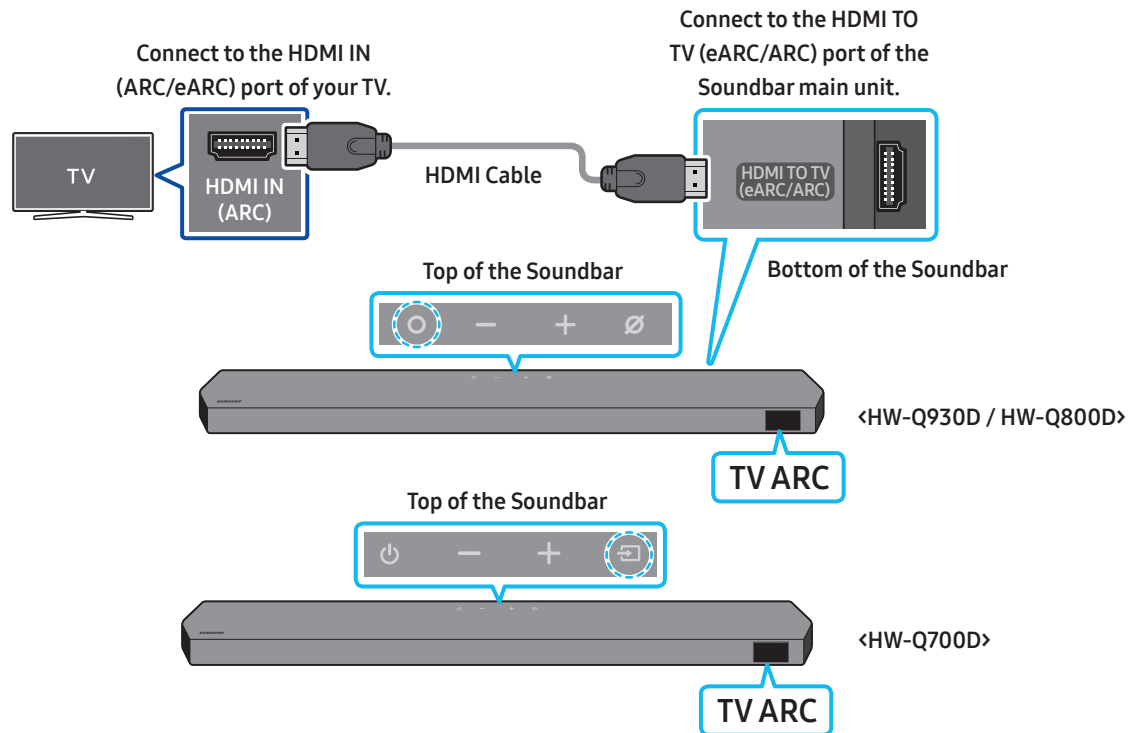

1. With the Soundbar and TV turned off, connect the HDMI cable as shown in the figure.
2. Turn on the Soundbar and TV.
3. "TV ARC" appears in the display window of the Soundbar main unit and the Soundbar plays TV sound.
  - When the TV sound is not output, press the **○ (Multi Function)** / **⇒ (Source)** button at the top of the Soundbar or the **⇒ (Source)** button on the remote control to select the "TV ARC" mode.
  - When connecting a TV that supports the eARC function, "TV eARC" appears on the display and the sound is heard.
  - To connect with eARC, the eARC function in the TV menu should be set to On. Refer to the TV user manual for details on setting. (e.g. Samsung TV : Home (🏠) → Menu → Settings (⚙) → All Settings (⚙) → Sound → Expert Settings → HDMI-eARC Mode (Auto))
  - If "TV ARC" does not appear in the display window of the Soundbar main unit, confirm that the HDMI cable is connected to the correct port.
  - Use the volume buttons on the TV's remote control to change the volume on the Soundbar.

### NOTE

- When you connect the TV that supports the HDMI ARC (Audio Return Channel) to the Soundbar with an HDMI cable, you can transmit the digital video and audio data without connecting a separate optical cable.
- We recommend you use a coreless HDMI cable if possible. If you use a cored HDMI cable, use one whose diameter is less than 14 mm.
- This function is not available if the HDMI cable does not support ARC.
- When the audio in a broadcast is encoded in Dolby Digital and the "Digital Output Audio Format" on your TV is set to PCM, we recommend that you change the setting to Dolby Digital. When the setting on the TV is changed, you will experience better sound quality. (The TV menu may use different words for Dolby Digital and PCM depending on the TV manufacturer.)
- The ARC/eARC protocols support Dolby Atmos.
- Make sure that the content supports Dolby Atmos®.

## Connecting using an Optical Cable

### Pre-connection Checklist

- When both the HDMI cable and optical cable are connected, the HDMI signal is received first.
- When you use an optical cable and the terminals have covers, be sure to remove the covers.

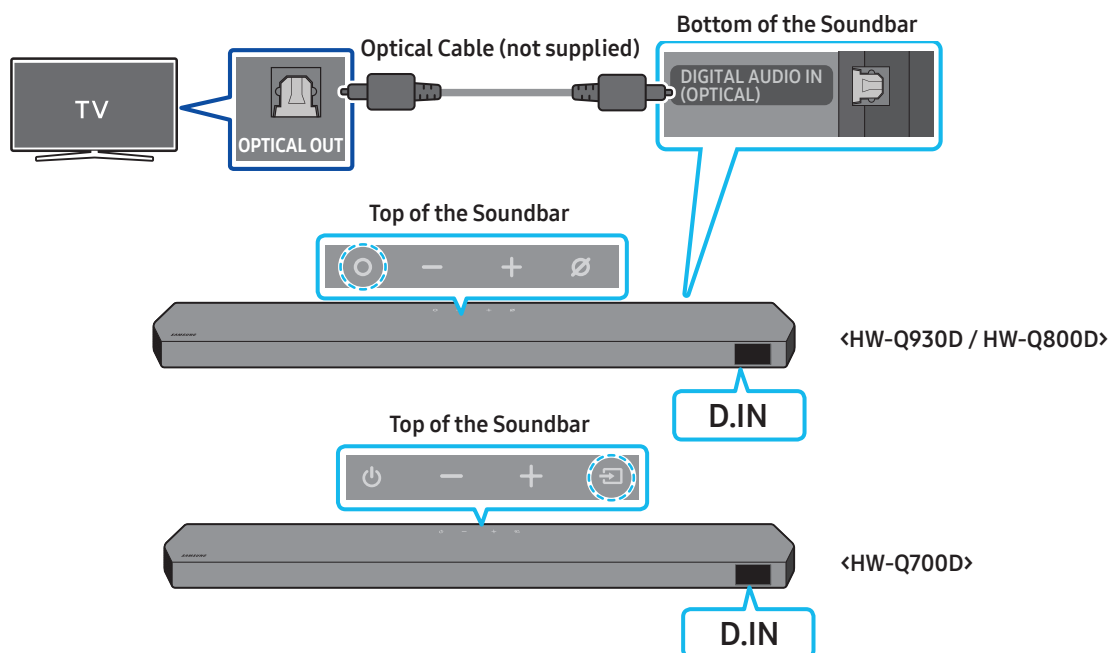

1. With the TV and Soundbar turned off, connect the **DIGITAL AUDIO IN (OPTICAL)** port on the Soundbar and the **OPTICAL** output port on the TV with an optical cable (not supplied), as shown in the figure.
2. Turn on the Soundbar and TV.
3. Press the **Multi Function** / **Source** button at the top of the Soundbar or the **Source** button on the remote control to select the "D.IN" mode.
4. The TV sound is output from the Soundbar.



## Connecting via Bluetooth

When a Samsung TV is connected using Bluetooth, you can hear stereo sound without the hassle of cabling.

- Only one Samsung TV can be connected at a time.
- Samsung TV that supports Bluetooth can be connected. Check the specifications of your TV.

### The initial connection

1. Press the **PAIR** button on the Soundbar remote control to enter the “**BT PAIRING**” mode.

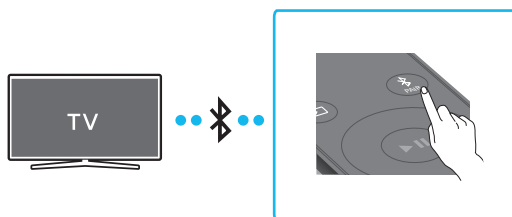

- (OR) a. Press the **(Multi Function)** / **(Source)** button on the top panel and then select “**BT**”.  
“**BT**” changes to “**BT PAIRING**” in a few seconds automatically or changes to “**BT READY**” if there is a connect record.

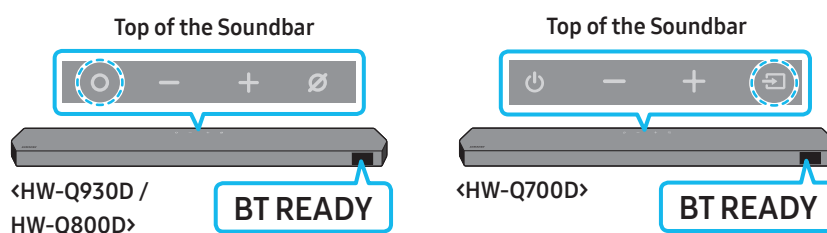

- b. When “**BT READY**” appears, press and hold the **(Mic On/Off)** / **(Source)** button on the top panel of the Soundbar for more than 5 seconds to display “**BT PAIRING**”.

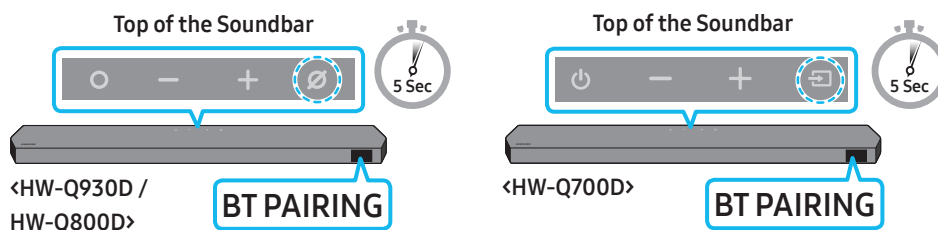

2. Select Bluetooth mode on the Samsung TV.  
(e.g. Home (🏠) → Menu → Settings (⚙️) → All Settings (⚙️) → Sound → Sound Output → Bluetooth Speaker List → Soundbar Q-Series (Bluetooth))
3. Select “**Soundbar Q-Series**” from the list on TV’s screen.  
An available Soundbar is indicated with “**Need Pairing**” or “**Paired**” on the TV’s Bluetooth device list. To connect the Samsung TV to the Soundbar, select the message, and then establish a connection.
  - When the Samsung TV is connected, [TV Name] → “**BT**” appears on the Soundbar’s front display.
4. You can now hear Samsung TV sound from the Soundbar.
  - After you have connected the Soundbar to your Samsung TV the first time, use the “**BT READY**” mode to reconnect.

#### If the device fails to connect

- If you have an existing Soundbar (e.g., **Soundbar Q-Series**) on the list of speakers on the Samsung TV, delete it.
- Then repeat steps 1 through 3.

### Disconnecting the Soundbar from the Samsung TV

Press the **(Multi Function)** / **(Source)** button at the top of the Soundbar or the **(Source)** button on the remote control to select the mode other than “**BT**”.

- Disconnecting takes time because the Samsung TV must receive a response from the Soundbar.  
(The time required may differ, depending on the Samsung TV model.)

## What is the difference between BT READY and BT PAIRING?

- **BT READY** : In this mode, you can reconnect any Samsung TV or mobile device that was connected before.
- **BT PAIRING** : In this mode, you can connect a new device to the Soundbar.  
(Press the **PAIR** button on the Soundbar remote control or press and hold the **⊘ (Mic On/Off)** / **↔ (Source)** button on the top of the Soundbar for more than 5 seconds while the Soundbar is in “BT” mode.)

## Notes on Bluetooth connection

- Locate a new device within 1 m to connect via Bluetooth communication.
- If asked for a PIN code when connecting a Bluetooth device, enter <0000>.
- The Soundbar automatically turns off after 18 minutes in the Ready state.
- The Soundbar may not perform Bluetooth search or connection correctly under the following circumstances:
  - If there is a strong electrical field around the Soundbar.
  - If several Bluetooth devices are simultaneously paired with the Soundbar.
  - If the Bluetooth device is turned off, not in place, or malfunctions.
- Electronic devices may cause radio interference. Devices that generate electromagnetic waves must be kept away from the Soundbar main unit - e.g., microwaves, wireless LAN devices, etc.
- To activate/deactivate Bluetooth connection  
Press the **TONE CONTROL** button on the remote control of the Soundbar for 30 seconds to turn Bluetooth On / Off.

# Connecting via Wi-Fi

## Pre-connection Checklist

- Wi-Fi connection is available only on Samsung TV.
- Check whether **the wireless router (Wi-Fi)** is turned on and **the TV is connected to the router**.
- The TV and Soundbar must be connected to the same wireless network (Wi-Fi).
- If your wireless router (Wi-Fi) uses a DFS channel, you will not be able to establish a Wi-Fi connection between the TV and Soundbar. Contact your Internet service provider for details.
- Because the menus may differ depending on the year of manufacture, refer to your TV manual.
- To connect the TV to the Soundbar via Wi-Fi, connect the Soundbar to the wireless router first. See page 26, for details on how to establish a Wi-Fi connection.

1. For more information about Wi-Fi connection to the Soundbar, see page 26, "**Method 2. Connecting via Wi-Fi (Wireless Network)**".

2. Change the input source of the TV by using the Audio menu to Soundbar.

- **Samsung TVs released in 2017 or later**

Home (🏠) → Menu → Settings (⚙️) → All Settings (⚙️) → Sound → Sound Output → Soundbar Q-Series (Wi-Fi)

## NOTE

- The Wi-Fi Dolby Atmos connection is available in some Samsung TVs and some Soundbar models.
- **Precaution : The Soundbar will restart automatically if you turn on/turn off Wi-Fi.**
- To activate/deactivate Wi-Fi connection  
Press the **CH LEVEL** button on the remote control of the Soundbar for 30 seconds to turn Wi-Fi On / Off.

## Using the Q-Symphony Function

- When the Soundbar connects to a Samsung TV that supports the Q-Symphony function you can play the sound simultaneously through the Soundbar and the TV. If you use the Q-Symphony function, the surround sound played on the TV allows you to enjoy a richer, more three-dimensional surround sound effect.
- When the Soundbar is connected “**Q-Symphony**” menu appears on the TV.  
Settings (⚙) → All Settings (⚙) → Sound → Sound Output
- TV menu example: **Q-Symphony**

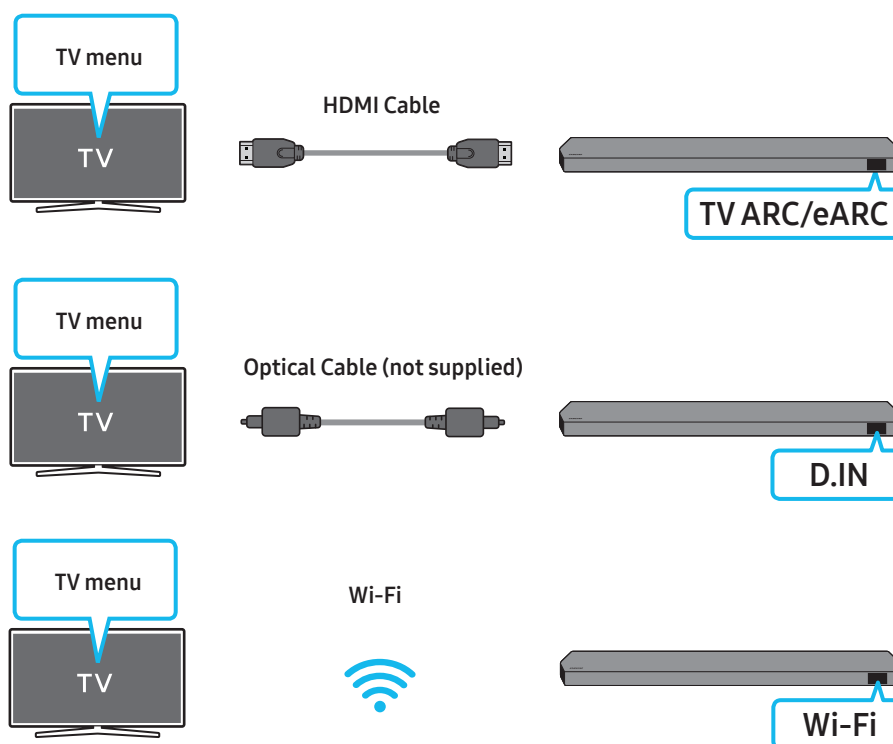

### NOTE

- It can operate according to the Codec supported by TV.
- This function is supported only when the HDMI Cable or Optical Cable (not supplied) or Wi-Fi is connected.
- The message displayed may differ with the TV model.
- Ensure that your TV and Soundbar are connected to the same wireless router/frequency.
- This function is available in some Samsung TVs and some Soundbar models.

# Using the SpaceFit Sound

This function analyzes the user's listening space with the Soundbar's microphone and provide optimal sound for the space. Sound optimization proceeds automatically.

## Method 1. Connecting via Soundbar

To enable this function, turn on the **SpaceFit Sound** mode with the remote control of the Soundbar.

1. Press the  (**Sound Control**) button to turn on the **SpaceFit Sound** mode.

"SPACEFIT SOUND OFF" appears on the display.

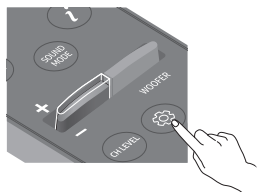

2. Press the **Up** button on the remote control to turn on the **SpaceFit Sound**.

"ON" appears on the display.

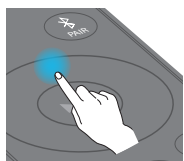

3. Press the **Down** button on the remote control to turn off the **SpaceFit Sound**.

"OFF" appears on the display.

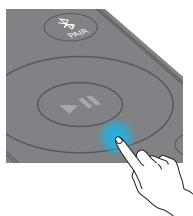

- This is available in all Sound modes.

## Method 2. Connecting via TV

To enable this function, turn on the Adaptive Sound+ mode on your Samsung TV menu.

(Home (🏠) → Menu → Settings (⚙️) → All Settings (⚙️) → General → Intelligent Mode Settings → Adaptive Sound+)

- The sound mode on your Soundbar will automatically change to **Adaptive Sound+** if you enable the **Adaptive Sound+** mode on your TV.

### NOTE

- This function works when the Soundbar connects to some of the Samsung TVs.
- **HW-Q700D** models support only the method of "Connecting via TV".

# 06 CONNECTING AN EXTERNAL DEVICE

## Method 1. Connecting using an HDMI Cable (Capable of Dolby Atmos / DTS:X decoding and playback)

### Pre-connection Checklist

- If the Audio Output options include Secondary Audio, make sure Secondary Audio is set to Off.
- Make sure that the content supports Dolby Atmos® / DTS:X.

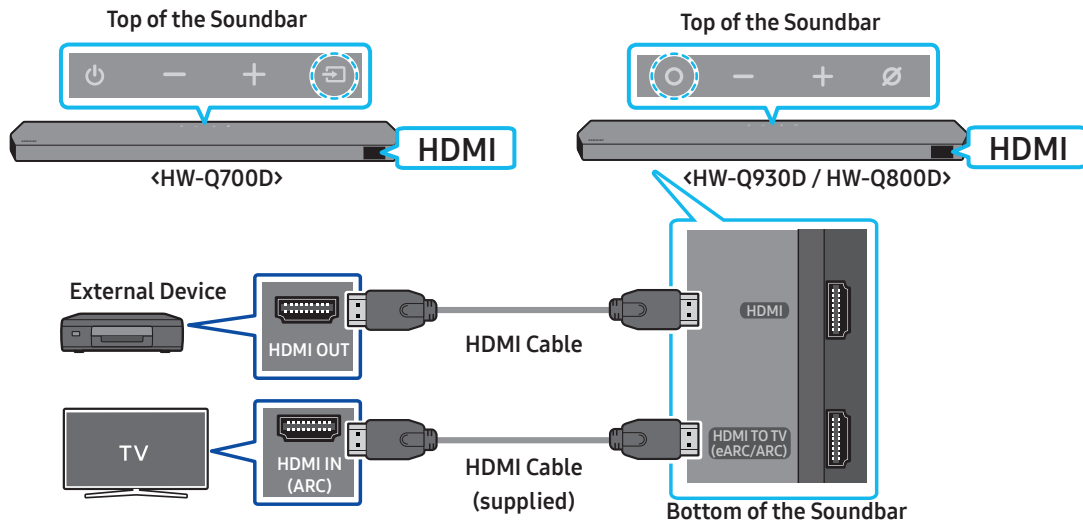

1. Use an HDMI cable to connect the HDMI OUT port on the external device and the HDMI port on the bottom of the Soundbar.
2. Use an HDMI cable (supplied) to connect the HDMI IN port of the TV and the HDMI TO TV (eARC/ARC) port on the bottom of the Soundbar.
3. Turn on the Soundbar, TV, and the external device.
4. Press the **○ (Multi Function) / (Source)** button on the top of the Soundbar or the  **(Source)** button on the remote control to select "HDMI" mode.
5. The Soundbar display indicates that "HDMI" mode is currently selected and the Soundbar will start playing sounds.

### NOTE

- **When you use Dolby Atmos® / DTS:X:** If the input source is Dolby Atmos® / DTS:X, refer to "Output specifications for the different sound effect modes" on page 8.
- When Dolby Atmos® is activated, "DOLBY ATMOS" appears in the front display.
- When DTS:X is activated, "DTS:X" appear in the front display.
- **Configuring Dolby Atmos® / DTS:X on your BD player or other device**  
Open the audio output options on the settings menu of your BD player or other device and make sure that "No Encoding" is selected for Bitstream. For example, on a Samsung BD Player, go to Home Menu → Sound → Digital Output and then select Bitstream (unprocessed).

### Supported UHD Signals Specification (3840 x 2160p)

Frame rate (fps)	Color depth	RGB 4:4:4	YCbCr 4:4:4	YCbCr 4:2:2	YCbCr 4:2:0
< 60	8 bit	0	0	0	0
	10 bit	-	-	0	0
	12 bit	-	-	0	0
120	8 bit	-	-	-	-
	10 bit	-	-	-	-

- Supported specification may vary depending on the connected external device or usage conditions.

## Method 2. Connecting using an Optical Cable

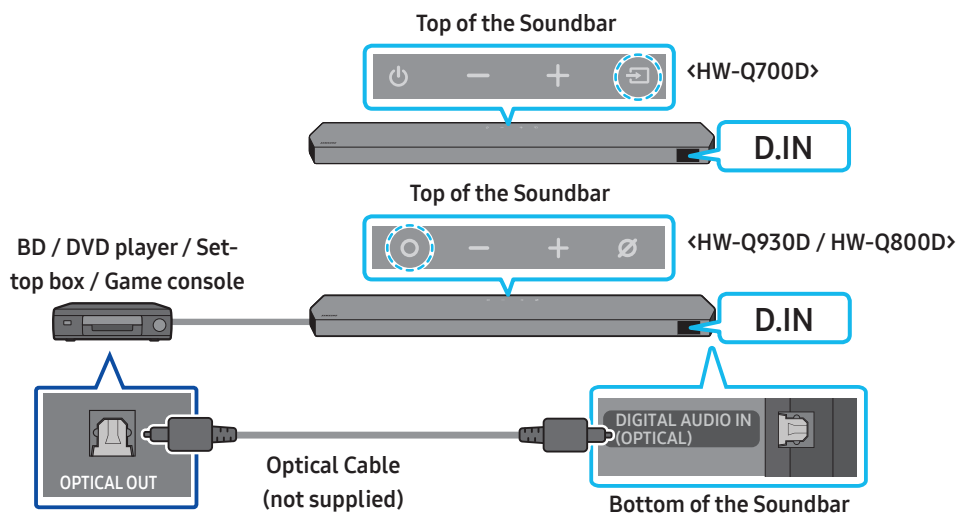

1. Use an optical cable (not supplied) to connect the **DIGITAL AUDIO IN (OPTICAL)** on the Soundbar main and the **OPTICAL OUT** port on the external device.
2. Turn on the Soundbar and external device.
3. To select "**D.IN**" mode, press the **○ (Multi Function) / ↗ (Source)** button on the top of the Soundbar or the **↗ (Source)** button on the remote control.
4. Your Soundbar will play sounds from the external device.

# 07 CONNECTING A MOBILE DEVICE

## Method 1. Connecting via Bluetooth

When a mobile device is connected using Bluetooth, you can hear stereo sound without the hassle of cabling.

- When you connect a paired Bluetooth device with the Soundbar off, the Soundbar automatically turns on.

### The initial connection

- When connecting to a new Bluetooth device, make sure the device is within 1 m distance.
1. Press the **PAIR** button on the Soundbar remote control to enter the “**BT PAIRING**” mode.

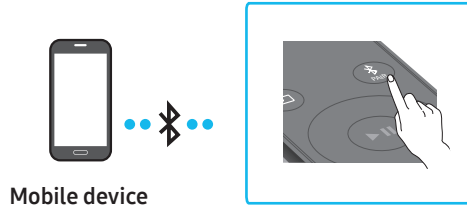

- (OR) a. Press the **Multi Function** / **Source** button on the top panel and then select “**BT**”.  
“**BT**” changes to “**BT PAIRING**” in a few seconds automatically or changes to “**BT READY**” if there is a connect record.

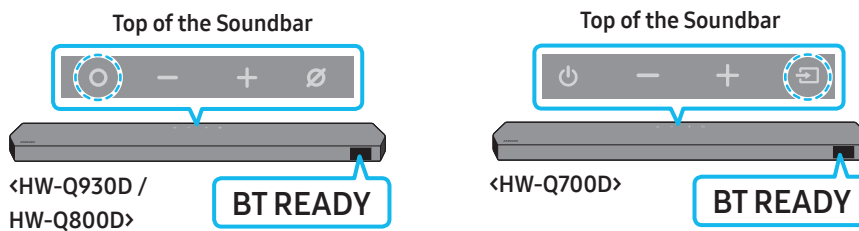

- b. When “**BT READY**” appears, press and hold the **Mic On/Off** / **Source** button on the top panel of the Soundbar for more than 5 seconds to display “**BT PAIRING**”.

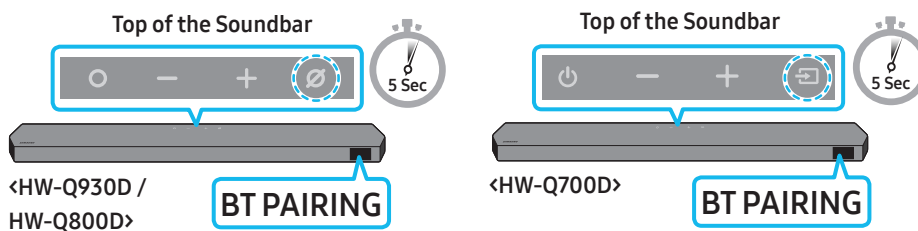

2. On your device, select “**Soundbar Q-Series**” from the list that appears.
  - When the Soundbar is connected to the Mobile device, [**Mobile Device Name**] → “**BT**” appears in the front display.
3. Play music files from the device connected via Bluetooth through the Soundbar.
  - After you have connected the Soundbar to your mobile device the first time, use the “**BT READY**” mode to reconnect.

### If the device fails to connect

- If you have an existing Soundbar (e.g., “**Soundbar Q-Series**”) in the list of speakers on the Mobile device, delete it.
- Repeat steps 1 and 2.

### What is the difference between BT READY and BT PAIRING?

- **BT READY** : In this mode, you can reconnect any Samsung TV or mobile device that was connected before.
- **BT PAIRING** : In this mode, you can connect a new device to the Soundbar.  
(Press the **PAIR** button on the Soundbar remote control or press and hold the **Mic On/Off** / **Source** button on the top of the Soundbar for more than 5 seconds while the Soundbar is in “**BT**” mode.)



## Notes on Bluetooth connection



- Locate a new device within 1 m to connect via Bluetooth communication.
- If asked for a PIN code when connecting a Bluetooth device, enter <0000>.
- The Soundbar automatically turns off after 18 minutes in the Ready state.
- The Soundbar may not perform Bluetooth search or connection correctly under the following circumstances:
  - If there is a strong electrical field around the Soundbar.
  - If several Bluetooth devices are simultaneously paired with the Soundbar.
  - If the Bluetooth device is turned off, not in place, or malfunctions.
- Electronic devices may cause radio interference. Devices that generate electromagnetic waves must be kept away from the Soundbar main unit - e.g., microwaves, wireless LAN devices, etc.
- The Soundbar supports SBC data (44.1kHz, 48kHz).
- Connect only to a Bluetooth device that supports the A2DP (AV) function.
- When connecting the Soundbar to a Bluetooth device, place them as close to each other as possible.
- The farther the Soundbar and Bluetooth device are from each other, the lower the sound quality will become. The Bluetooth connection may break when the devices are out of the effective range.
- The Bluetooth connection may not function as intended in areas with poor reception.
- A Bluetooth device may experience noise or malfunction under in the following conditions:
  - When the body is in contact with the signal transceiver on the Bluetooth device or Soundbar
  - In corners or when there is an obstacle in proximity, such as a wall or partition, where electrical changes may occur.
  - When exposed to radio interferences by other products operating on the same frequency ranges, such as medical equipment, microwave ovens, and wireless LAN devices.
  - Obstacles such as doors and walls may still impact the sound quality even when the devices are within the effective range.
- Note that your Soundbar cannot be paired with other Bluetooth devices while using the Bluetooth option.
- This wireless device may cause electrical interference during operation.

## Disconnecting the Bluetooth device from a Soundbar

You can disconnect a Bluetooth device from the Soundbar. For instructions, see the Bluetooth device's user manual.

- The Soundbar will be disconnected.
- When the Soundbar is disconnected from the Bluetooth device, the Soundbar will display **"BT DISCONNECTED"** on the front display.

## Disconnecting the Soundbar from the Bluetooth device

Press the **○ (Multi Function) /  (Source)** button on the top of the Soundbar or the ** (Source)** button on the remote control to switch the mode from **"BT"**.

- Disconnecting takes time because the Bluetooth device must receive a response from the Soundbar. (Disconnection time may differ, depending on the Bluetooth device)
- When the Soundbar is disconnected from the Bluetooth device, the Soundbar will display **"BT DISCONNECTED"** on the front display.

## Method 2. Connecting via Wi-Fi (Wireless Network)

To connect a Soundbar to a mobile device via a wireless network (Wi-Fi), the **SmartThings** app is required.

### The initial connection

1. Install and launch the **SmartThings** app from your mobile device (smartphone or tablet).
2. On the app, follow the screen instructions to add the Soundbar.
  - The automatic pop-up (the second screenshot below) may not show on some devices.  
If the pop-up window does not appear, press “+” on the **Home** screen. The Soundbar is added to the app.
  - The illustration below may differ according to the app version.

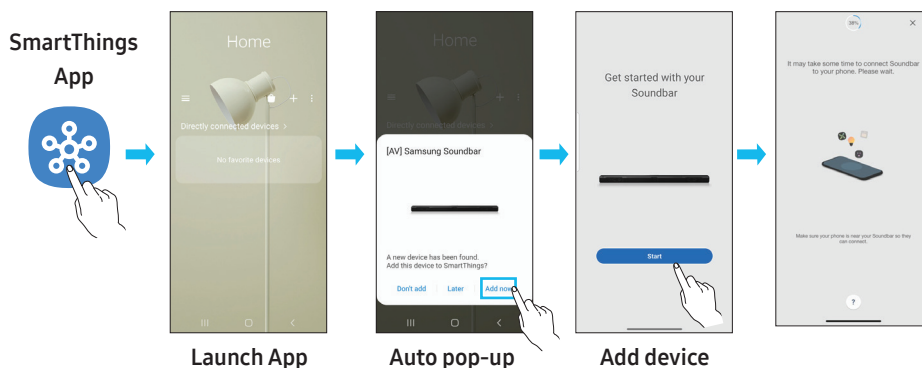

### To change your Wi-Fi connection

1. Launch the **SmartThings** app from your mobile device (smartphone or tablet).
2. Tap the Soundbar's card and tap the (  ) icon.
3. Go to Device Settings > Network Status > Change Wi-Fi network, and follow the onscreen instructions.

## Using Group Play

- To benefit from this feature, add your Soundbar to the SmartThings app.
- To enable this, connect at least two audio devices to the same Wi-Fi network at 5 GHz.
- This is available on Samsung Sound devices that support Wi-Fi released year 2024 or later.
- This feature does not support TV sound.

### Configuring Group Play

1. Run the **SmartThings** app on your mobile device.
2. Add the Soundbar in the **SmartThings** app according to the instructions in the “**Method 2. Connecting via Wi-Fi (Wireless Network)**” section.
3. Tap the Soundbar's card.
4. On your mobile device, tap **Create Group** under the audio device icon.
  - **Create Group** button appears only when Soundbar is in Wi-Fi mode.
  - If the Soundbar is playing the TV sound, the connection to the TV is disconnected when creating a group.
5. Enable **Group Play**.
6. Select a desired device in the list, and tap **Apply**.
  - You can add a maximum of 4 devices.
  - With **Group Play**, the audio will be output through the host device alone.
  - When a device connected to the host device switches to a different source, the device will be deleted from the group automatically.
  - When the host device is connected to a TV, the generated group will be deleted automatically.

### Disabling Group Play

1. Tap the audio device's card.
2. On your mobile device, tap **Edit Group** under the audio device icon.
3. Disable **Group Play**.
  - To disable an individual device, uncheck the device from the list and tap **Apply**.

## Connecting via Apple AirPlay

- This feature may not be available in some countries.
- This Samsung Soundbar supports AirPlay and recommends that the user use the latest version of iOS, iPadOS, or macOS.
- To enable AirPlay in your Soundbar, you must first register the device with the Samsung Smart Things app by agreeing with the app's terms and conditions.
- Make sure the Soundbar is powered on and connected to the same Wi-Fi network as your Apple device.

With AirPlay, you can enjoy music, podcasts, and other audio on the Samsung Soundbar right from your Apple devices.

- Select  from an AirPlay-supported app or Control Center on your iPhone, iPad, or Mac.
- Select the Soundbar from the list of available devices to play the current audio to.

## Using the Tap Sound

Tap the Soundbar with your mobile device to play the sound of content on the mobile device through the Soundbar.

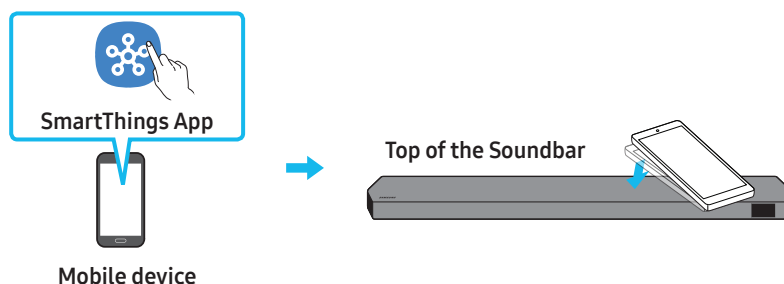

- This function may not be supported, depending on the mobile device.
- This function is only compatible with Samsung mobile devices with Android 8.1 or later.



1. Turn on the **Tap Sound** function on your mobile device.
  - For details on how to turn on the function, refer to “**Setting the Tap Sound function**” below.
2. Tap the Soundbar with the mobile device. Select “**Start now**” in the displayed message window. A connection is established between the mobile device and Soundbar via Bluetooth.
3. Play the sound of content on the mobile device through the Soundbar.
  - This function connects a mobile device to the Soundbar via Bluetooth by detecting vibration that occurs when the device touches the Soundbar.
  - Make sure the mobile device does not tap a sharp corner of the Soundbar. The Soundbar or mobile device may become scratched or damaged.
  - It is recommended that the mobile device be covered with a case. Lightly tap the wide area in the upper portion of the Soundbar, without using excessive force.
  - To use this function, update the **SmartThings** app to the latest version. The function may not be supported, depending on the app version.

## Setting the Tap Sound function

Use the **SmartThings** app to turn on the **Tap View, Tap Sound** function.

1. On the mobile device, run the **SmartThings** app.
2. Select (  →  ) in the **SmartThings** app screen displayed on the mobile device.
3. Set “**Tap View, Tap Sound**” to On to allow the function to work when a mobile device moves close to the Soundbar. The function is turned on.

### NOTE

- When the mobile device is in power-saving mode, the **Tap Sound** function does not work.
- The **Tap Sound** function may not work if there are devices near the Soundbar that cause radio interference such as electric devices. Make sure devices that may cause radio interference are placed at a sufficient distance away from the Soundbar.

# 08 INSTALLING THE WALL MOUNT

## Installation Precautions

- Install on a vertical wall only.
- Do not install in a place with high temperature or humidity.
- Verify whether the wall is strong enough to support the product's weight. If not, reinforce the wall or choose another installation point.
- Purchase and use the fixing screws or anchors appropriate for the kind of wall you have (plaster board, iron board, wood, etc.). If possible, fix the support screws into wall studs.
- Purchase wall mounting screws according to the type and thickness of the wall you want to mount the Soundbar on.
  - Diameter: M5
  - Length: 35 mm or longer recommended.
- Connect cables from the unit to external devices before you install the Soundbar on the wall.
- Make sure the unit is turned off and unplugged before you install it. Otherwise, it may cause an electric shock.

## Wallmount Components

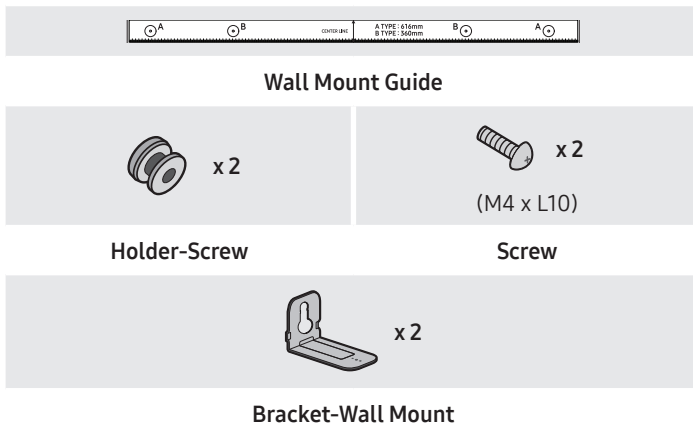

1. Place the **Wall Mount Guide** against the wall surface.
  - The **Wall mount** guide must be leveled.
  - If your TV is mounted on the wall, install the Soundbar at least 5 cm below the TV.

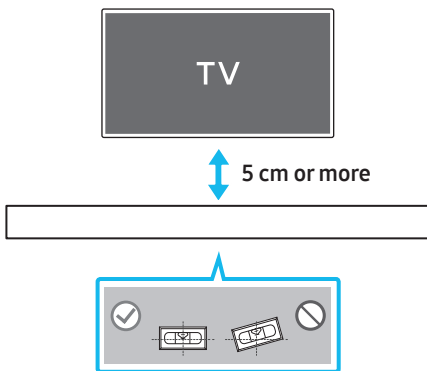

2. Align the **Wall Mount Guide's Center Line** with the center of your TV (if you are mounting the Soundbar below your TV), and then fix the **Wall Mount Guide** to the wall using tape.
  - If you are not mounting below a TV, place the **Center Line** in the center of the installation area.

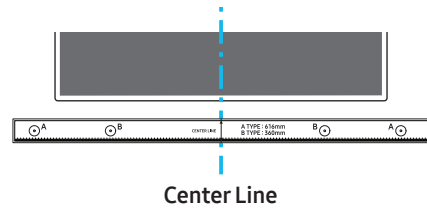

3. Push a pen tip or sharpened pencil tip through the center of the **A-TYPE** images on each end of the Guide to mark the holes for the supporting screws, and then remove the **Wall Mount Guide**.

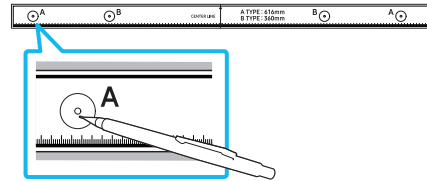

4. Using an appropriately sized drill bit, drill a hole in the wall at each marking.
  - If the markings do not correspond to the positions of studs, make sure you insert appropriate anchors or mollys into the holes before you insert the support screws. If you use anchors or mollys, make sure the holes you drill are large enough for the anchors or mollys you use.
5. Push a screw (not supplied) through each **Holder-Screw**, and then screw each screw firmly into a support screw hole.

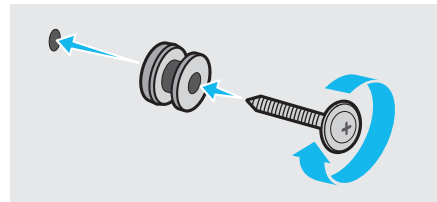

6. Install the **2 Bracket-Wall Mounts** in the correct orientation on the bottom of the Soundbar using **2 Screws**.

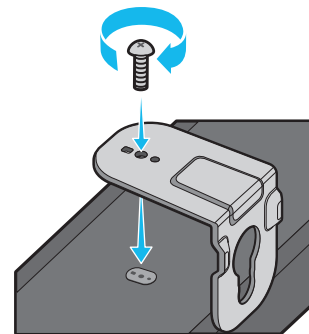

- When assembling, make sure the hanger part of the **Bracket-Wall Mounts** are located behind the rear of the Soundbar.

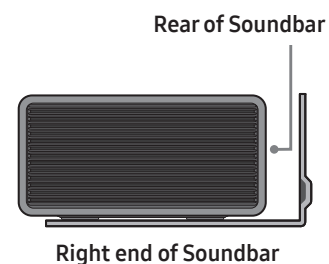

- Install the Soundbar with the attached **Bracket-Wall Mounts** by hanging the **Bracket-Wall Mounts** on the **Holder-Screws** on the wall.

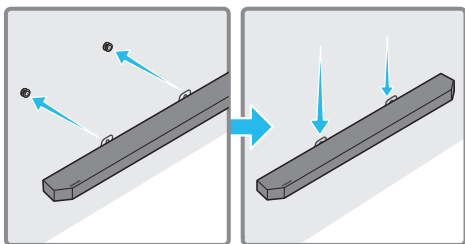

- Slide the Soundbar down as shown below so that the **Bracket-Wall Mounts** rest securely on the **Holder-Screws**.

- Insert the **Holder-Screws** into the wide (bottom) part of the **Bracket-Wall Mounts**, and then slide the **Bracket-Wall Mounts** down so that the **Bracket-Wall Mounts** rest securely on the **Holder-Screws**.

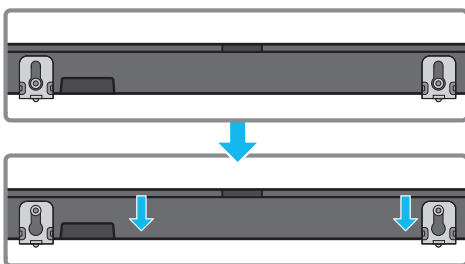

## Installing the Surround Speakers on a Wall (applicable models only)

You can purchase wall mounts separately to install the surround speakers on a wall.

Wall mounts aren't sold by Samsung Electronics.

### Notes for Wall Mounting the Surround Speakers

- Surround Speaker wall mounts must be able to support more than 8.0 kg.
- Hole size : 1/4 - 20 UNC threaded insert
  - Standard Screw : 6.35 mm  $\varnothing$ , 1.27mm Pitch
  - Length : 18 mm long
  - Quantity : Left 1 EA / Right 1 EA

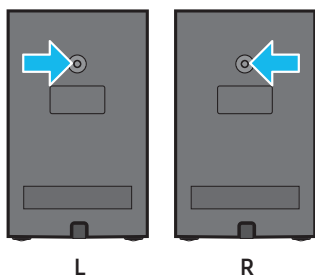

- Check the strength of the wall before you install the Wall Mount Brackets. If the strength is insufficient, make sure to reinforce the wall before installing the Wall Mount Brackets and the speakers on the wall.
- Samsung Electronics is not liable for any damage to the product due to the product being installed inappropriately.
- Take care not to install the speakers sideways or upside down.

# 09 INSTALLING THE SOUNDBAR IN FRONT OF TV

## Component



Rubber-Foot

To install, attach the **Rubber-Feet** to the bottom of the Soundbar before placing it in position above the TV stand. Make sure you attach the **Rubber-Feet** so they do not lie outside the edges of the TV stand. Refer to the figure below.

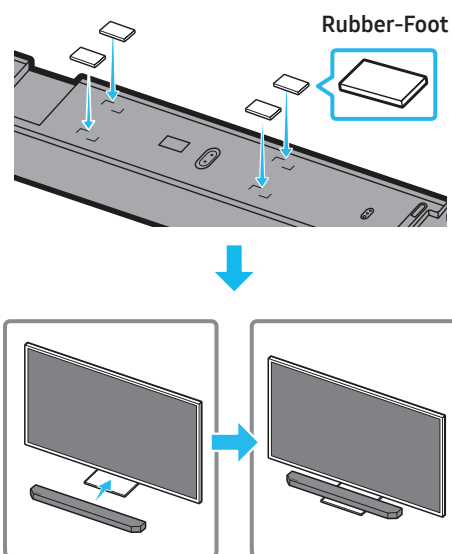

Place the Soundbar on a TV stand.

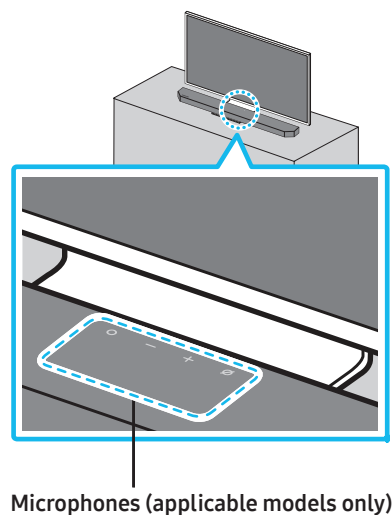

As illustrated in the image, align the center of the Soundbar with the center of the TV, carefully place the Soundbar onto the TV stand. At this time, place the microphones (applicable models only) at the front of the stand not to interfere with voice recognition.

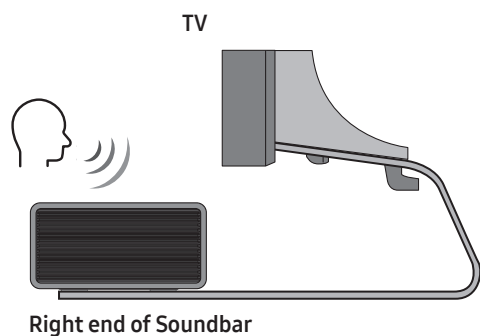

#### NOTE

- Make sure the Soundbar is placed on a flat and solid surface.
- Insufficient gap from the TV may cause voice recognition and acoustic problems.
- The illustration above differs from the respective model.
- This function is not supported by **HW-Q700D** model.
- For the best performance of the microphones, keep the Soundbar at least 2 cm away from the TV's panel.

## 10 SOFTWARE UPDATE

### Auto Update

When the Soundbar is connected to the Internet, software updates automatically occur even when the Soundbar is turned off.

- To use the Auto Update function, the Soundbar must be connected to the Internet.

The Wi-Fi connection to the Soundbar will be terminated if the Soundbar's power cord is disconnected or the power is cut off. If the power is cut off, when the power comes back on or you reconnect the power cord, turn on the Soundbar, and then reconnect it to the Internet.

### USB Update

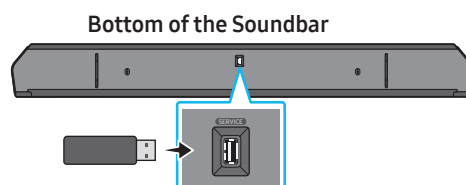

**Samsung may offer updates for the Soundbar's system firmware in the future.**

When an update is available, you can update the Soundbar by connecting the USB drive that contains the update firmware to the **SERVICE** port of the Soundbar.

1. Go to the Samsung Electronics website ([www.samsung.com](http://www.samsung.com)) → search for the model name from the customer support menu option.
  - For more information about update, refer to Upgrade Guide.
2. Download the upgrade file (USB type).
3. Unzip the file to create a folder with the file name.
4. Store the created folder in a USB and then connect it to the Soundbar.
5. Turn on the Soundbar. Then the product is updated within 3 minutes with displaying the message, "**UPDATE**".
  - During update, do not turn it off or remove the USB.
  - If "**UPDATE**" does not appear on the display window, remove the power cord from the Soundbar and then reconnect it.
  - When the latest version is installed, no update is performed.
  - Depending on the USB type, update may not be supported.

### Security updates information

Security updates are provided to strengthen the security of your device and protect your personal information. For more information on security updates, visit <https://security.samsungtv.com>.

- The website supports only some languages.

## Initialization

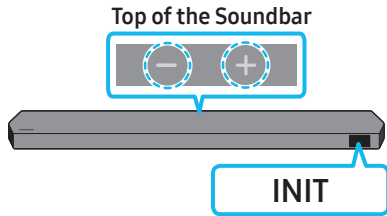

With the Soundbar on, press the **— + (Volume)** buttons on the body at the same time for at least 5 seconds. "INIT" appears on the display and then the Soundbar is initialized.

### ⚠ CAUTION

- All the settings of the Soundbar are initialized. Be sure to perform this only when initialization is required.

## 11 TROUBLESHOOTING

Before seeking assistance, check the following.

### Soundbar does not turn on.

- Check whether the power cord of the Soundbar is correctly inserted into the outlet.

### Soundbar works erratically.

- After removing the power cord, insert it again.
- Power cycle the external device and try again.
- If there is no signal, the Soundbar automatically turns off after a certain period of time. Turn on the power. (See page 6.)

### Remote control does not work

- Point the remote directly at the soundbar.
- Replace the batteries with new ones.

### The Soundbar indicator turns solid red.

- The microphone is turned off.  
Turn on the microphone. (See page 4.)

### Sound is not output from the soundbar.

- The volume of the Soundbar is too low or muted. Adjust the volume.
- When any external device (STB, Bluetooth device, mobile device, etc.) is connected, adjust the volume of the external device.
- For sound output of the TV, select Soundbar. (Samsung TV: Home (🏠) → Menu → Settings (⚙) → All Settings (⚙) → Sound → Sound Output → Select Soundbar)
- The cable connection to the Soundbar may not be loose. Remove the cable and connect again.
- Remove the power cord completely, reconnect, and turn the power on.
- Initialize the product and try again. (See page 31.)

### Sound is not output from the Subwoofer or the rear speakers.

- Check whether the LED indicator on the rear of the Subwoofer and Surround Speakers are on in blue. Reconnect the Soundbar and Subwoofer and Surround Speakers if the indicator is blinking in blue or turned red. (See page 13.)
- You may experience an issue if there is an obstacle between the Soundbar and Subwoofer. Move devices to an area away from obstacles.
- Other devices sending radio frequency signals in proximity may interrupt the connection.  
Keep your speaker away from such devices.
- Remove and reconnect the power plug.

#### In case there is sound jitter, delays, or noise from the Subwoofer and Surround Speaker

- If there are any objects between the Soundbar and Subwoofer speaker, this could cause a problem. Please reposition these to a place without such an object.
- There may be sound jitter or delays when the Subwoofer and Surround Speaker are far from the Soundbar. Please place them near the Soundbar.
- There may be sound jitter or delays when the Soundbar is near an instrument or electrical device that can cause radio interference. Place the Soundbar far from such devices that can cause radio interference. (E.g., wireless router)
- Change the TV network connection status from wireless to wired.

#### The Subwoofer volume is too low

- The original volume of the content you are playing may be low. Try adjusting the Subwoofer level. (See page 7.)
- Bring the Subwoofer speaker closer to you.

#### If the TV is not connected via HDMI TO TV (eARC/ARC)

- Check whether the HDMI cable is connected properly to the ARC terminal. (See page 15.)
- Connection may not be possible due to the connected external device (set-top box, game machine, etc.). Directly connect the Soundbar.
- HDMI-CEC may not be activated on the TV. Turn on the CEC on the TV menu. (Samsung TV: Home (🏠) → Menu → Settings (⚙️) → All Settings (⚙️) → Connection → External Device Manager → Anynet+ (HDMI-CEC) ON)
- To connect with eARC, the eARC function in the TV menu should be set to On. (Samsung TV: Home (🏠) → Menu → Settings (⚙️) → All Settings (⚙️) → Sound → Expert Settings → HDMI-eARC Mode (Auto))

#### There is no sound in when connecting to the TV in HDMI TO TV (eARC/ARC) mode

- Your device is unable to play the input signal. Change the TV's audio output to PCM or Dolby Digital. (For a Samsung TV: Home (🏠) → Menu → Settings (⚙️) → All Settings (⚙️) → Sound → Expert Settings → Digital Output Audio Format)

#### Soundbar will not connect via Bluetooth.

- When connecting a new device, switch to "BT PAIRING" for connection. (Press the **PAIR** button on the remote control or press the **⊘ (Mic On/Off)** / **📶 (Source)** button on the body for at least 5 seconds.)
- If the Soundbar is connected to another device, disconnect that device first to switch the device.
- Reconnect it after removing the Bluetooth speaker list on the device to connect. (Samsung TV: Home (🏠) → Menu → Settings (⚙️) → All Settings (⚙️) → Sound → Sound Output → Bluetooth Speaker List)
- The automatic TV connection may be disabled. While the Soundbar is in "BT READY", press and hold the **Left** button on the Soundbar remote control for 5 seconds to select **ON-TV CONNECT**. If you see **OFF-TV CONNECT**, press and hold **Left** button again for 5 seconds to switch the selection.
- Remove and reconnect the power plug, then try again.
- Initialize the product and try again. (See page 31.)

#### Sound drops out when connected via Bluetooth.

- Some devices can cause radio interference if they are located too close to the Soundbar. e. g. microwaves, wireless routers, etc.
- If your device that is connected via Bluetooth moves too far away from the soundbar, it may cause the sound to drop out. Move the device closer to the soundbar.
- If a part of your body is in contact with the Bluetooth transceiver or the product is installed on metal furniture, the sound may drop out. Check the installation environment and conditions for use.

#### Soundbar will not connect to Wi-Fi.

- Check whether your wireless router is on.
- Turn off the router, turn it back on, and then try again.
- The soundbar will not connect if the wireless signal is too weak. Try moving the router closer to the soundbar, or eliminating any obstacles that are between the soundbar and the router, if possible.
- If your wireless router is new, you will need to reconfigure the speaker's network settings. (See page 26.)
- Soundbar does not support Wi-Fi 6.

#### The soundbar does not turn on automatically with the TV.

- When you turn off the Soundbar while watching TV, power synchronization with the TV is disabled. First turn off the TV.

#### The AVA function (applicable models only) is not available in the following cases.

- The AVA function (applicable models only) will not be available when the microphone is turned off.



**After connecting the TV to the Soundbar, I switched the Soundbar mode. Then no sound is output from the TV.**

- If you connect your Soundbar to a mobile device while the Soundbar is connected to the TV, the Soundbar outputs sound from the mobile device while keeping the TV connection. So the TV sound will not be delivered anywhere.
- Disconnect the mobile device, and the TV sound will be output from the Soundbar again.

#### **The Soundbar does not appear in AirPlay**

- To enable AirPlay in your Soundbar, you must first register the device with the Samsung Smart Things app by agreeing with the app's terms and conditions. (See page 27.)
- AirPlay does not operate if you delete the Soundbar from the Samsung Smart Things app.
- Make sure that the Soundbar and the Apple device are connected to the same Wi-Fi network.
- The Soundbar is compatible with AirPlay installed on iOS 13.4 or later.

#### **Group Play is not enabled**

- Check if the audio devices are newer models released year 2024 or later.
- Check if the host device is connected to a Wi-Fi network as source.
- Make sure that all audio devices are connected to the same Wi-Fi network (at 5 GHz).

## 12 LICENCE



Dolby, Dolby Atmos, and the double-D symbol are registered trademarks of Dolby Laboratories Licensing Corporation. Manufactured under license from Dolby Laboratories. Confidential unpublished works.

Copyright © 2012-2021 Dolby Laboratories. All rights reserved.



For DTS patents, see <http://patents.dts.com>. Manufactured under license from DTS, Inc. or DTS Licensing Limited. DTS, DTS:X, and the DTS:X logo are registered trademarks or trademarks of DTS, Inc. in the United States and other countries.

© 2021 DTS, Inc. ALL RIGHTS RESERVED.



The terms HDMI, HDMI High-Definition Multimedia Interface, HDMI Trade dress and the HDMI Logos are trademarks or registered trademarks of HDMI Licensing Administrator, Inc.



Apple, AirPlay, iPad, iPhone, and Mac are trademarks of Apple Inc., registered in the U.S. and other countries and regions.



- Use your phone, tablet or computer as a remote control for Spotify. Go to [spotify.com/connect](https://spotify.com/connect) to learn how
- The Spotify Software is subject to third party licenses found here: <https://www.spotify.com/connect/third-party-licenses>.



Being Roon Tested means that Samsung and Roon have collaborated to ensure you have the best experience using Roon software and Samsung equipment together, so you can just enjoy the music.

#### **Open Source License Notice**

Open Source used in this product can be found on the following webpage (<http://opensource.samsung.com>).