



WASHING MACHINE
USER MANUAL
HW105-B14959S8U1

- Please read this manual carefully before using washing machine.
- Retain it for future reference.

For U1 Series Models:

Download and Install Haier Smart APP

Scan the instruction page QR code with your mobile phone to download and install Haier Smart APP client.

Registration and Login

Connect to the home Wi-Fi, open the Haier Smart APP, register an account and log in, click the "+" symbol in the upper right corner, select the washing machine, select the corresponding model, and press and hold the Power button until C5 appears on the washing machine interface, and then connect the phone to Wi-Fi called "U WM", the washing machine automatically associates with the mobile phone to complete the binding.



Registration is required only the first time you use the APP, For further use, you only have to enter the user name and password to use the APP when successfully registered.

Function of APP

Equipment control: Select program mode, set program parameters, start program mode, pause, shutdown, etc.

Status View: View the running status of the device in real time.

Information reception: receiving various prompts such as fault alarm, etc.



The APP function will be updated continuously with the upgrade of the version, which is subject to the actual function of the corresponding version.



In the shutdown state, long press the Power button for 9 seconds, the display will show C5, then continue to hold the operation, the display will show U ON, indicating that Wi-Fi is on; on the contrary, In the shutdown state, long press the Power button for 9 seconds, the display will show C5, then continue to hold the operation, the display will show U OFF, indicating that Wi-Fi is off,



Thank you for purchasing a Haier Product.

Please read these instructions carefully before using this appliance. The instructions contain important information which will help you get the best out of the appliance and ensure safe and proper installation, use and maintenance.

Keep this manual in a convenient place so you can always refer to it for the safe and proper use of the appliance.

If you sell the appliance, give it away, or leave it behind when you move house, make sure you also pass this manual so that the new owner can become familiar with the appliance and safety warnings.

Legend



Warning – Important Safety information



General information and tips



Environmental information



1. Help protect the environment and human health.
2. Help to recycle waste of electrical and electronic appliances.
3. Do not dispose appliances marked with this symbol with the household waste.

For further information on environmental friendly disposal please visit ewaste manual @ attached with this document or visit https://www.haier.com/in/e-waste-guidelines/?spm=in.abouthaierin_pc.footer_bottom_20190530.3



WARNING!

Risk of injury or suffocation!

Disconnect the appliance from the mains supply. Cut off the mains cable and dispose of it. Remove the door catch to prevent children and pets to get closed in the appliance.

1-Safety Information.....	4
2-Product Description.....	7
3-Control Panel.....	8
4-Programme.....	12
5-Daily Use.....	13
6-Eco-friendly Washing	18
7-Care and Cleaning.....	19
8-Troubleshooting.....	22
9-Installation.....	25
10-Technical Data.....	29
11-E-Waste Guideline	30
12-Warranty Terms	32

BRAND INTRODUCTION

Haier Group —

Established in 1984, Haier Group is a world-leading provider of solutions to beautiful life. Haier has topped Euromonitor's World Home Appliance Brands and its subsidiary Haier Smart Home Co., Ltd. is among the Fortune Global 500 Companies. Thank you for purchasing Haier product.

Haier

Before switching on the appliance for the first time read the following safety hints!



WARNING!

Before first use

- ▶ Make sure there is no transport damage.
- ▶ Make sure all transport bolts are removed.
- ▶ Remove all packing and keep out of children's reach.
- ▶ Handle the appliance always with at least two persons because it is heavy.

Daily use

- ▶ This appliance can be used by children aged from 8 years and above and persons with reduced physical, sensory or mental capabilities or lack of experience and knowledge if they have been given supervision or instruction concerning use of the appliance in a safe way and understand the hazards involved.
- ▶ Keep away children under 3 years of age from the appliance unless they are constantly supervised.
- ▶ Children shall not play with the appliance.
- ▶ Do not let children or pets come close to the appliance when the door is open. Store washing agents out of reach of children.
- ▶ Pull up zips, fix loose threads and take care for small items to prevent laundry from being entangled. If necessary, use an appropriate bag or net.
- ▶ Do not press or use the appliance when barefoot or with wet or damp hands or feet.
- ▶ Do not cover or encase the appliance during operation or afterwards to allow any moisture or dampness to evaporate.
- ▶ Do not place heavy objects or sources of heat or damp on top of the appliance.
- ▶ Do not use or store flammable detergent or dry cleaning agent in close vicinity to the appliance.
- ▶ Do not use any flammable sprays in close vicinity to appliance.
- ▶ Do not wash any garments treated with solvents in the appliance without having dried them previously in the air.



WARNING!

Daily use

- ▶ Do not remove or insert the plug in the presence of flammable gas.
- ▶ Do not hot wash foam rubber or sponge-like materials.
- ▶ Do not wash any laundry which is polluted with flour.
- ▶ Do not open detergent drawer during any wash cycle.
- ▶ Do not press the door during the washing process, it gets hot.
- ▶ Do not open the door if the water level is visibly over the port hole.
- ▶ Do not force the door to open. The door is fitted with a self-lock device and will open shortly after the washing procedure is ended.
- ▶ Switch off the appliance after each wash programme and before undertaking any routine maintenance and disconnect the appliance from the electricity supply to save electricity and for safety.
- ▶ Hold the plug, not the cable, when unplugging the appliance.

Maintenance/cleaning

- ▶ Make sure children are supervised if they carry out cleaning and maintenance.
- ▶ Disconnect the appliance from the electrical supply before undertaking any routine maintenance.
- ▶ Keep the lower part of the porthole clean and open door and detergent drawer if appliance is not in use to prevent odours.
- ▶ Do not use water spray or steam to clean the appliance.
- ▶ Replace a damaged supply cord only by the manufacturer, its service agent or similarly qualified persons in order to avoid a hazard.
- ▶ Do not try to repair the appliance by yourself. In case of repair please contact our customer service.

Installation

- ▶ The appliance should be placed in a well-ventilated place. Ensure a location which allows opening the door fully.
- ▶ Never install the appliance outdoors in a damp place, or in an area which may be prone to water leaks such as under or near a sink unit. In the event of a water leak cut power supply and allow the machine to dry naturally.



WARNING!

Installation

- ▶ Use the appliance only where the temperature is above 5 °C.
- ▶ Do not place the appliance directly on a carpet, or close to a wall or furniture.
- ▶ Do not install the appliance in direct sunlight or in the near of heat sources (e.g. stoves, heaters).
- ▶ Make sure that the electrical information on the rating plate agrees with the power supply. If it does not, contact an electrician.
- ▶ Do not use multi-plug adapters and extension cables.
- ▶ Make sure only the delivered electric cable and hose set are used.
- ▶ Make sure not to damage the electric cable and the plug. If damaged have it replaced by an electrician.
- ▶ Use a separate earthed socket for the power supply which is easily accessible after installation. The appliance must be earthed.
- ▶ Make sure the hose joints and connections are firm and there is no leakage.

Intended use

This appliance is intended for washing machine-washable laundry only. Always follow the instructions given on the label of each garment label. It is not intended for commercial or industrial use.

Changes or modifications to the device are not allowed. Unintended use may cause hazards and loss of all warranty and liability claims.

i Note:

Due to technical changes and different models, the illustrations in the following chapters may differ from your model.

2.1 Picture of appliance

Front (Fig. 2-1):

Rear side (Fig. 2-2):

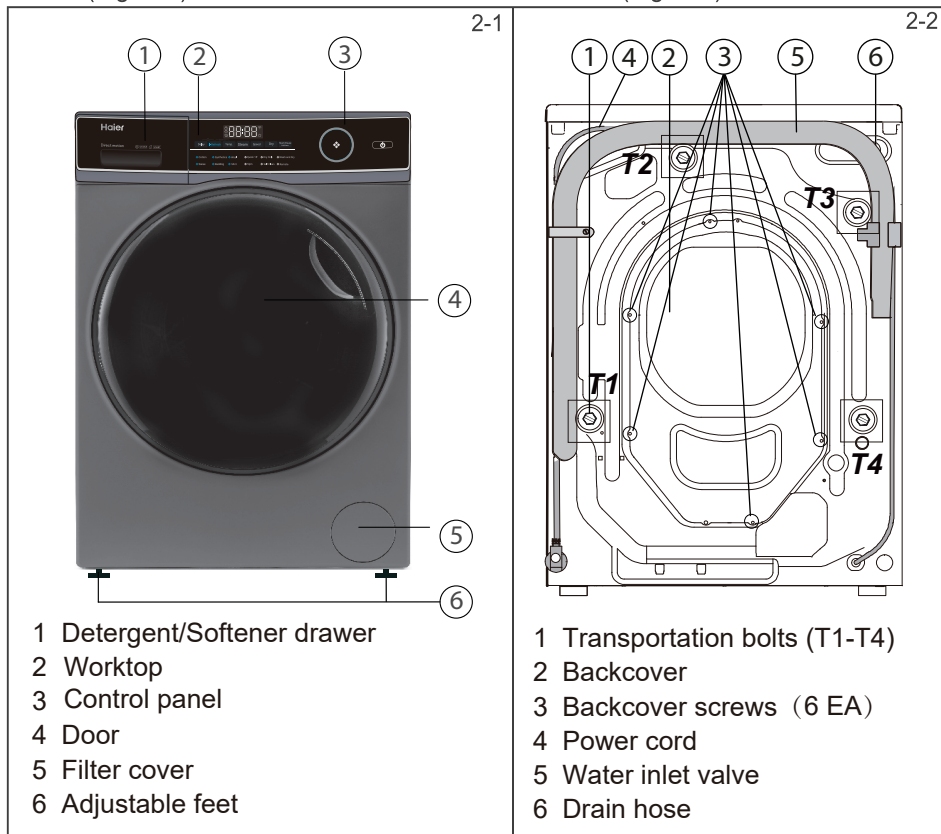

2.2 Accessories

Check the accessories and literature in accordance with this list (Fig. 2-3):

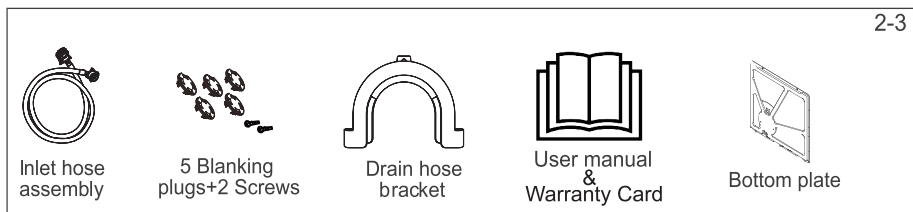

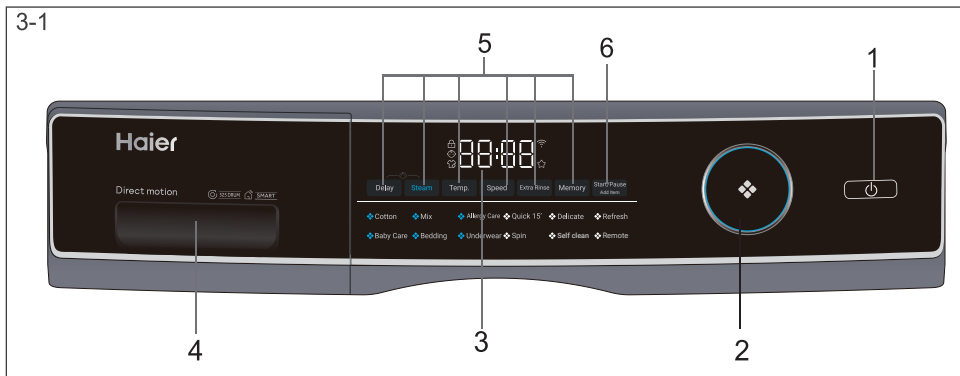

- | | | |
|----------------------|-------------------------------|------------------------------------|
| 1 "Power" button | 3 Display | 5 Function buttons |
| 2 Programme selector | 4 Detergent / Softener drawer | 6 "Start/Pause" button
Add Item |

i Note : Acoustic signal

In following cases an acoustic signal sounds:

- ▶ when pressing a button
- ▶ at the end of programme
- ▶ when selecting the programme
- ▶ in case of failures

The acoustic signal can be deselected if necessary; see DAILY USE.

3-2



3.1 "Power" button

Touch this button (Fig.3-2) gently to switch on, the display is shining, Press it again for about 2 seconds to switch off. If no panel element or programme is activated after a while machine will shut down automatically.

3-3

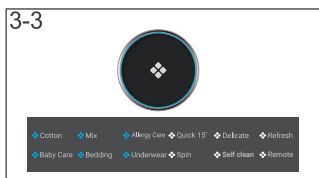

3.2 Programme selector

By turning the knob (Fig. 3-3), one of 12 programmers can be selected, related LED will light up.

3-4



3.3 Display

The display (Fig. 3-4) shows following information:

- ▶ Washing / Drying time
- ▶ End time delay
- ▶ Error codes and service information
- ▶ Display symbols
- ▶ Speed, Temperature, etc

3.4 Detergent drawer

Open the drawer, two compartments can be seen (Fig. 3-5):

1 Compartment 1: Podwer or Liquid detergent for programme.

2 Compartment 2: Softener, Conditioning agent etc. The recommendation on the type of detergents is suitable for the various washing temperatures, please refer to the manual of detergent.

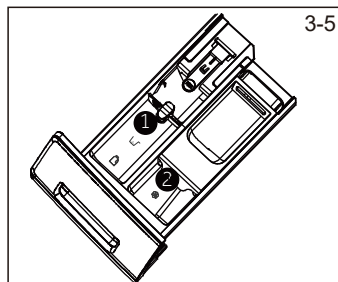

3.5 Function buttons

The function buttons (Fig. 3-6) enable additional options in the selected programme before programme starts. The related indicators are displayed.

If a button has multiple options, the desired option can be selected by touching the button sequentially.

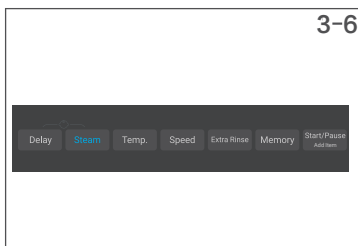

Note: Factory settings

To get best results in each programme Haier has well defined specific default settings. If there is no special requirement default settings are recommended.

3.5.1 Function button “Delay”

Press this button (Fig.3-6) to start the programme with a delay. End time delay could be increase in steps of 30 minutes from 0.5-24h. When you select the delay, the total time will default to longer than the programme run time. For example, display off 6:30 means end of programme cycle will be in 6 hours and 30 minutes. Press “Start/Pause” button to activate the time delay.

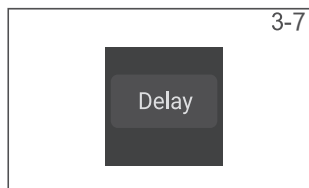

3.5.2 Function button “ Steam ”

Press this button (Fig 3-8) to select the steam program, then the current program temperature value will be changed to the maximum allowed value. The maximum temperature value can be viewed on the page of the parameters table in the manual. You can select if you require this function when programmers “Cotton, Synthetics, Allergy Care, Mix, Baby Care, Daily, Underwear ” are used. The icon will light up when using the steam wash function.



3.5.3 Function button “Temp.”

Press this button (Fig. 3-9) to change the washing temperature of the programme. If no value is illuminated the water will not be heated.

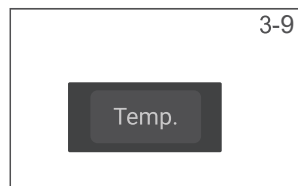

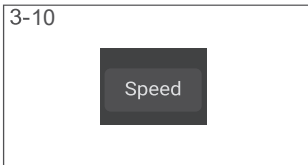

3.5.4 Function button “Speed”

Press this button (Fig. 3-10) to change or deselect the spin of the programme. If no value is illuminated the laundry will not spun.

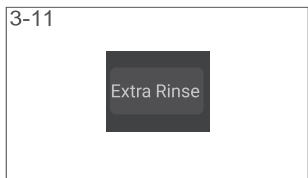

3.5.5 “Extra Rinse” button

Press this button (Fig. 3-11) to rinse the laundry more intense with fresh water. This is recommended for people with sensitive skin.

By touching the button several times zero to two additional cycles can be selected. They appear in the display with P--0/P--1/P--2.

i Note:Liquid detergent

If using liquid detergent, it is not recommended to activate the end time delay.



3.5.6 “Memory” button

After selecting the program, complete the parameter setting, press and hold this function key for 3 seconds, and the digital tube will display “SAVE”, lower right corner “☆”light up, The icon is lit, the memory is successful.

After switching programs, the memory icon disappears; When standby, press this function key to automatically switch back to the last stored program;

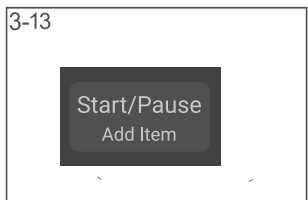

3.6 Start/Pause Add Item” button

Press this button (Fig. 3-13) gently to start or interrupt the currently displayed programme. During the washing process, press this button, if the door can be opened, you add clothes to continue cleaning, and vice versa (It is recommended to use the "Add Item" function during the washing stage)

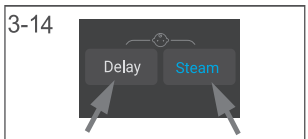

3.7 Child lock

Press button Delay and “Steam” (Fig. 3-14) for 3 seconds simultaneously to all panel elements against activation. For unlocking please touch again the two buttons. The child lock indicator lights up when the child lock works. This feature is optional when the machine is running.



The display shows “c l o t”(Fig. 3-15) if a button will be pressed that means the child lock is activated. The change is not running.

**Note: Child lock**

- ▶ The child lock which is set up manually must be cancelled manually or will be canceled automatically at the end of the programme. Power off and error information won't cancel child lock. It still works when the appliance is powered on next time.
- ▶ If you use the child lock, first press the program key, then the child lock will be on.
- ▶ Hold it for 3 seconds, the child lock will turn to full light and the child lock will be activated.
- ▶ Child lock can't be set up or cancelled through hOn APP.

o Optional, / No

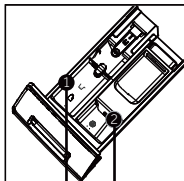

Detergent compartment for:
 ① Detergent
 ② Softener or care product

Programme	Max. load in kg	Temperature ¹⁾ in °C	Preset			Fabric type	Preset spin speed in rpm	Function		
				1	2			Steam	Extra Rinse	Delay
HW105-B14959S8U1		selectable range								
Cotton	10.5	* to 90	30	<input type="radio"/>	<input type="radio"/>	Cotton	1000	<input type="radio"/>	<input type="radio"/>	<input type="radio"/>
Mix	10.5	* to 60	30	<input type="radio"/>	<input type="radio"/>	Lightly soiled mixed-laundering of cotton and synthetic	1000	<input type="radio"/>	<input type="radio"/>	<input type="radio"/>
Allergy Care	5.25	* to 90	60	<input type="radio"/>	<input type="radio"/>	Cotton/ synthetics	1000	<input type="radio"/>	<input type="radio"/>	<input type="radio"/>
Quick 15 ²⁾	2.5	* to 40	*	<input type="radio"/>	<input type="radio"/>	Cotton/ synthetics	1000	/	<input type="radio"/>	<input type="radio"/>
Delicate	2.5	* to 30	30	<input type="radio"/>	<input type="radio"/>	Delicate laundry and silk	600	/	<input type="radio"/>	<input type="radio"/>
Refresh	/	/	/	/	/	Cotton/ synthetics	/	/	/	/
Baby Care	5.25	* to 90	40	<input type="radio"/>	<input type="radio"/>	Cotton/ synthetics	1000	<input type="radio"/>	<input type="radio"/>	<input type="radio"/>
Bedding	5.25	* to 60	30	<input type="radio"/>	<input type="radio"/>	Bedding	1000	<input type="radio"/>	<input type="radio"/>	<input type="radio"/>
Underwear	5.25	* to 60	40	<input type="radio"/>	<input type="radio"/>	Underwear	1000	<input type="radio"/>	<input type="radio"/>	<input type="radio"/>
Spin	10.5	/	/	/	/	Not-fragile fabric	1000	/	/	/
Self clean	/	*90	90	/	/	/	/	/	/	/
Remote	/	/	/	/	/	Cotton/ synthetics	/	/	/	/

* Water is not heated up.

1) Choose 90°C wash temperature only for special hygienic requirements.

2) Reduce detergent amount because programme duration is short.

3) When washing heavy loads, the washing machine may vibrate greatly or move if clothes are wrpped.

4) The design and specifications are subject to change without notice for quality improvement purposes.

4.1 BEE Programming:

Step 1: Select the "Cotton" programme.

Step 2: Select the Temp range to 60°C

Step 3: Press speed button and select 1400 rpm.

Then start the programme for BEE programme.

5.1 Power supply

Connect the washing machine to a power supply (220V/50Hz; Fig. 5-1). Please refer also to section INSTALLATION.

5.2 Water connection

- ▶ Before connecting check the cleanliness and clarity of the water inlet.
- ▶ Turn on the tap (Fig. 5-2).

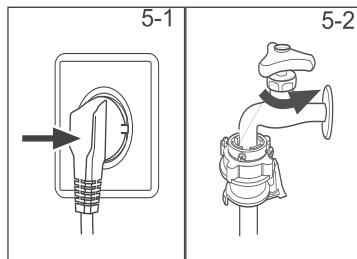

i Note: Tightness

Before use check for leakage in the joints between the tap and the inlet hose by turning on the tap.

5.3 Preparing laundry

- ▶ Sort out clothes according to fabric (cotton, synthetics, wool or etc.) and how dirty they are (Fig. 5-3). Pay attention to the care labelling of washig labels.
- ▶ Separate white clothes from coloured ones. Wash coloured textiles first by hand to check if they fade or run.
- ▶ Empty pockets (keys, coins, etc.) and remove harder decorative objects (e.g. brooches).
- ▶ Garments without hems, delicates and finely woven textile such as fine curtains are to be put into a wash bag to care for this delicate laundry (hand or dry cleaning would be better).
- ▶ Close zippers, velco fastener and hooks, make sure the buttons are sewn on tightly.
- ▶ Place sensitive items like laundry without firm hem, delicate underwear and small items such as socks, belts, bras, etc. in a wash bag.
- ▶ Unfold large pieces of fabric such as bed sheets, bedspreads etc.
- ▶ Turn jeans and printed, decorated or color-intensive textiles inside out; possibly wash separately.

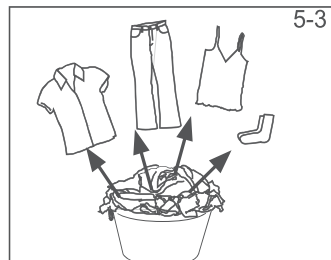

! CAUTION!

Non-textile, as well as small, loose or sharp-edged items may cause malfunctions and damage of clothes and appliance.

Care chart

Washing		
 Washable up to 95°C normal process	 Washable up to 60°C normal process	 Washable up to 60°C mild process
 Washable up to 40°C normal process	 Washable up to 40°C mild process	 Washable up to 40°C very mild process
 Washable up to 30°C normal process	 Washable up to 30°C mild process	 Washable up to 30°C very mild process
 Wash by hand max. 40°C	 Do not wash	
Bleaching		
 Any bleaching allowed	 Only oxygen/non-chlorine	 Do not bleach
Drying		
 Tumble drying possible normal temperature	 Tumble drying possible lower temperature	 Do not tumble dryer
 Line drying	 Flat drying	
Ironing		
 Iron at a maximum temperature up to 200°C	 Iron at a medial temperature up to 150°C	 Iron at a low temperature up to 110°C; without steam (steam ironing may cause irreversible damage)
 Do not iron		
Professional Textile Care		
 Dry cleaning in tetra-chloroethene	 Dry cleaning in hydrocarbons	 Do not dry clean
 Professional wet clean	 Do not professional wet clean	

5.4 Loading the appliance

- ▶ Put in the laundry piece by piece.
- ▶ Don't overload. Note the different maximum load according to programmes! Rule of thumb for maximum load: Check if you can put a hand upright on top of load.
- ▶ Close the door carefully. Make sure that no pieces of laundry are pinched.

5.5 Selecting detergent

- ▶ Washing efficiency and performance is determined by used detergent quality.
- ▶ Use only machine wash approved detergent.
- ▶ If needed use specific detergents, e.g. synthetic and woolen fabric.
- ▶ Mind always detergent manufacturer recommendations.
- ▶ Do not use dry cleaning agents such as trichloroethylene and similar products.

Choose the best detergent

Programme	Kind of detergent				
	Universal	Colour	Delicate	Special	Softener
Cotton	√	√	-	-	√
Mix	√L	√	-	-	√
Allergy Care	-	-	√	√	√
Quick 15'	√L	√L	-	-	√
Delicate	-	-	√	√	√
Baby Care	-	-	√	√	√
Bedding	√P	√	-	-	√
Underwear	-	-	√	√	√
Spin	-	-	-	-	-
Self clean	-	-	-	√	-
Refresh	√	-	-	√	√
Remote	√	√	-	√L	√

L = gel-/liquid detergent P = powder detergent O = optional - = no
 √ = Recommended

If using liquid detergent, it is not recommended to activate the time delay.

We recommend by using:

- ▶ Laundry powder: 20°C to 90°C* (best use:40-60°C).
- ▶ Color detergent: 20°C to 60°C (best use:30-60°C).
- ▶ Wool/delicate detergent: 20°C to 30°C (best use:20-30°C).

* Choose 90°C wash temperature only for special hygienic requirements.

 It is better to use less or free suds detergent powder.

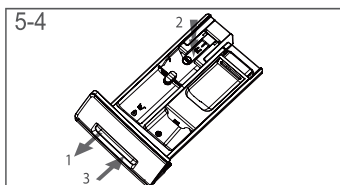

5.6 Adding detergent

1. Slide out the detergent drawer.
2. Put the required chemicals into corresponding compartments (Fig. 5-4).
3. Push back the drawer gently.

i Note:

- ▶ Remove detergent residues before next wash cycle from the detergent drawer.
- ▶ Do not overuse detergent or softener.
- ▶ Please follow the instruction on the detergent package.
- ▶ Always fill the detergent just before the beginning of the wash cycle.
- ▶ Concentrated liquid detergent should be diluted before adding into compartment 2.
- ▶ The best use of liquid detergent is by using a dosing ball, which is given with the laundry into the washing machine.
- ▶ Do not use liquid detergent if “end time delay” is selected.
- ▶ Carefully choose the programme settings according to the care symbols on all laundry labels and according to the programme table.

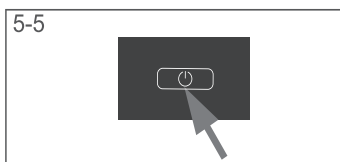

5.7 Switch on the appliance

Touch the “Power” button to switch on the appliance (Fig. 5-5).

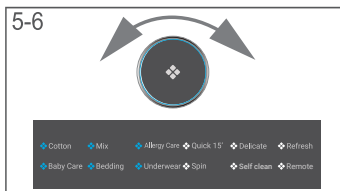

5.8 Select a programme

To get the best washing results, select a programme which fits the degree of soiling and sort of laundry type.

Turn the programme knob (Fig. 5-6) to select the right programme.

i Note: Odour removal

Before first use we recommended to run programme Drum Clean with no load and small amount of detergent in washing agent compartment (2) or special machine cleaner to remove possibly corrosive residues.

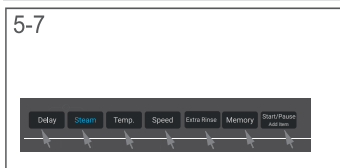

5.9 Add individual selections

Select required options and settings (Fig. 5-7); refer to CONTROL PANEL.

5.10 Start wash programme

Press “Start/Pause” button (Fig. 5-8) to start. Appliance operates according to present settings. Changes are only possible by cancelling the programme.



5.11 Interrupt / cancel wash programme

To interrupt a running programme press gently “Start/Pause”. The LED in the button is flashing. Press it again to resume operation.

To cancel a running programme and all its individual settings:

1. Press “Start/Pause” button to interrupt the running programme.
2. Turn the knob to select a new programme and start it.

5.12 After washing



Note: Door lock

- ▶ For safety reasons the door is locked partially during the washing cycle. It is only possible to open the door at the end of the programme or after the programme was cancelled correctly (see description above).
- ▶ In case of high water level, high water temperature and during spinning it is not possible to open the door; **Ldck!** is displayed.

1. At programme cycle end **End** is displayed.
2. The appliance switches off automatically.
3. Remove laundry as soon as possible to go easy on it and to prevent more wrinkling.
4. Turn off the water supply.
5. Unplug the power cord.
6. Open the door to prevent formation of moisture and odours. Let it open while not used. minutes before starting the programme or at the end of programme. The display switches off.



Note: Standby mode / energy-saving mode

The switched on appliance will go into standby mode if it will not be activated within 2 minutes before starting the programme or at the end of programme. The display switches off.

5.13 Activate or deactivate the buzzer

The acoustic signal can be deselected if necessary:

1. Switch on the appliance.
2. Select the **Self Clean** programme.
3. Press the “Delay” button and “Temp.” button at the same time for about 3 seconds. “**bEEP OFF**” will be displayed and the buzzer will be deactivated.

For activating the buzzer press these three buttons at the same time again, then “**bEEP ON**” will be displayed.



Environmentally responsible use

- ▶ To achieve best use of energy, water, detergent and time you should use the recommended maximum load size.
- ▶ Do not overload (hand width clearance above laundry).
- ▶ For slightly solid laundry select the Quick 15' programme.
- ▶ Apply exact dosages of each washing agent.
- ▶ Choose the lowest adequate washing temperature - modern detergents are efficiently cleaning below 60 °C.
- ▶ Raise default settings only due to heavy staining.
- ▶ Select max. spinning speed if a domestic dryer is used.

7.1 Cleaning the detergent drawer

Take always care there are no detergent residues. Clean the drawer regularly (Fig. 7-1):

1. Pull out the drawer until it stops.
2. Press there lease button and remove the drawer.
3. Flush the drawer with water until it is clean and insert the drawer back in the appliance.

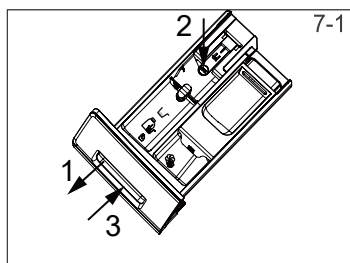

7.2 Cleaning the machine

- ▶ Unplug the machine during cleaning and maintenance.
- ▶ Use a soft cloth with soap liquid to clean the machine case (Fig. 7-2) and rubber components.
- ▶ Do not use organic chemicals or corrosive solvents.



7.3 Water inlet valve and inlet valve filter

To prevent blockage of water supply by solid substances like lime clean regularly the inlet valve filter.

- ▶ Unplug the power cord and turn off the water supply.
- ▶ Unscrew the water inlet hose at the back (Fig.7-3.1).
- ▶ Remove the filters and flush them with water and a brush (Fig.7-3.2).
- ▶ Insert the filter and install the inlet hose.

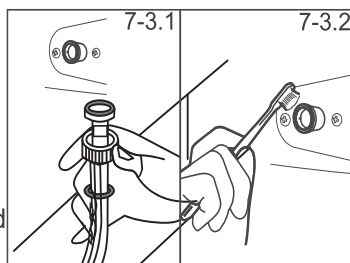

7.4 Cleaning the drum

- ▶ Remove accidentally washed metal parts such as pins, coins, etc. from the drum (Fig. 7-4) because they cause rust stains and damage.
- ▶ Use a non-chloride cleaner for removing rust stains. Observe the warning hints of the cleaning agent manufacturer.
- ▶ Do not use any hard objects or steel wool for cleaning.

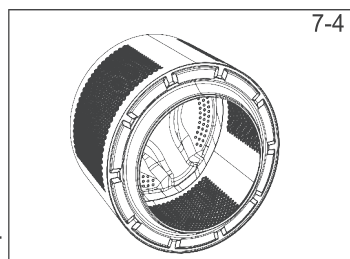

i Note: Drum Clean / Self Clean

For regular maintenance we recommend to run programme Self Clean with no load in order to remove possible corruptive residues quarterly. Add a small amount of detergent in washing agent compartment (2) - or use a special machine cleaner.

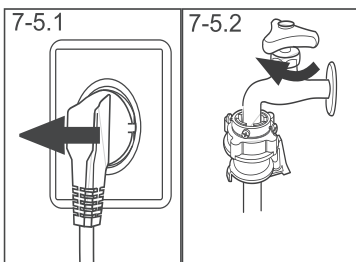

7.5 Long periods of disuse

If the appliance is left idle for a longer period:

1. Pull out the electrical plug (Fig. 7-5.1).
2. Turnoff water supply (Fig. 7-5.2).
3. Open the door to prevent formation of moisture and odours. Let door open while not used.

Before next usage check carefully power cord, water inlet and drain hose. Make sure everything is properly installed and without leakage.

i Note: Hygiene

After long periods of disuse we recommended to run programme Drum Clean with no load and small amount of detergent in washing agent compartment (2) or special machine cleaner to remove possibly corruptive residues.

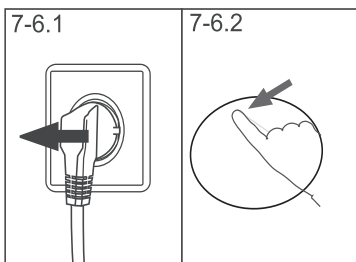

7.6 Pump filter

Clean the filter once a month and check the pump filter for instance if the appliance:

- ▶ Doesn't drain the water.
- ▶ Doesn't spin.
- ▶ Cause unusual noise while running.

! WARNING!

Scalding Risk! Water in the pump filter can be very hot! Before any action please ensure water has cooled down.

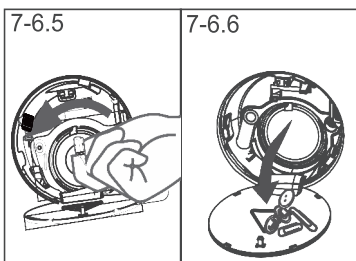
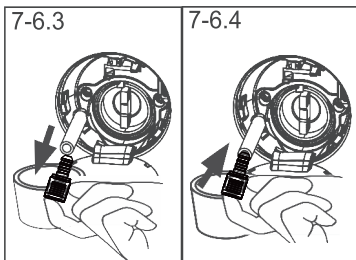

1. Turnoff and unplug the machine (Fig. 7-6.1).
2. Open service flap (Fig. 7-6.2).
3. Provide a flat container to catch leach water (Fig. 7-6.3). There could be bigger amounts!
4. Pull the drain hose out and hold its end above the container (Fig. 7-6.3).
5. Take the sealing plug out of the drainhose (Fig. 7-6.3).
6. After complete drainage close drainhose (Fig. 7-6.4). and push it back into the machine.
7. Unscrew and remove counter clock wise the pump filter (Fig. 7-6.5).
8. Remove contaminants and dirt (Fig. 7-6.6).

9. Clean carefully pump filter, e.g. using running water (Fig. 7-6.7).
10. Refix it thoroughly (Fig. 7-6.8).
11. Close service flap.

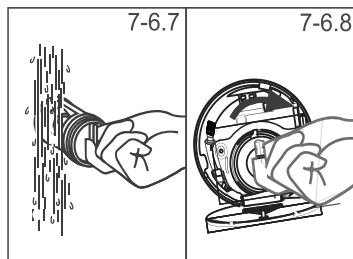

CAUTION!

- ▶ Pump filter sealing has to be clean and unhurt. If the lid is not fully tightened, water can escape.
- ▶ The filter must be in place, or it may lead to leakage.

7.1 WIFI Activation And Usage

- Step 1: Scan below QR Code for app Download and install (available on manual also)
- Step 2: App Home Page
- Step 3: For User Login (For New Account Register).
- Step 4: Add Smart Product (WM)
- Step 5: Select Product
- Step 6: Select Model
- Step 7: Press "Power Button" 5 Seconds until the machine shows C5
- Step 8: Click Blue Tick and Press Next
- Step 9: Mobile through which App operated should be connected to same network as Machine.
- Step 10: Search same Wi-Fi network & input Wi-Fi password. Press Connect Network
- Step 11: Process start of Connecting Machine
- Step 12: If not connected, needs to do "Connect Manually"
- Step 13: After Connected, for using can Press "Use Immediately"
- Step 14: Complete Loading 100%.
- Step 15: Need to open Remote Authorization of Washing Machine.
- Step 16: Turn the Knob to Remote Function, to start operating through App.
- Step 17: Start using App, various Online Programs available.
 - Programs will update as per new feature addition through Wi-Fi application.

Many occurring problems could be solved by yourself without specific expertise. In case of a problem please check all shown possibilities and follow below instructions before you contact an after sales service. See CUSTOMER SERVICE.



WARNING!

- ▶ Before maintenance, deactivate the appliance and disconnect the mains plug from the mains socket.
- ▶ Electrical equipment should be serviced only by qualified electrical experts, because improper repairs can cause considerable consequential damages.
- ▶ A damaged power cable should only be replaced by the manufacturer, its service agent or similarly qualified persons in order to avoid a hazard.

8.1 Information codes

Following codes are displayed only for information referring to the washing cycle. No measures must be performed.

Code	Message
00:25	The remaining wash cycle time will be 1 hour and 25minutes.
06:30	The remaining wash cycle time including chosen end-time delay will 6 hours and 30 minutes.
0000	The washing cycle is finished. The appliance shuts off automatically.
0000	Function child lock is activated.
0000	Door is closed because of high water level, high water temperature or spinning cycle.
0000 00	The buzzer is activated.
0000 000	The buzzer is deactivated.

8.2 Troubleshooting with display code

Problem	Cause	Solution
000 0000	• Drainage error, water is not fully drained within 6 minutes.	• Clean pump filter. • Check drain hose installation.
00	• Lock error.	• Shut the door properly.
00	• Water level not reached after 8 minutes, at the latest. • Drain hose is self-syphoning.	• Make sure that tap is fully opened and water pressure is normal. • Check drain hose installation.
00	• Water protective level error.	• Contact the After sales service.
00	• Temperature sensor error.	• Contact the After sales service.
00	• Heating error.	• Contact the After sales service.

Problem	Cause	Solution
EE	<ul style="list-style-type: none"> Motor error. 	<ul style="list-style-type: none"> Contact the After sales service.
EE8 or EE8	<ul style="list-style-type: none"> Abnormal communication error. 	<ul style="list-style-type: none"> Contact the After sales service.
EE8	<ul style="list-style-type: none"> Unbalanced load error. 	<ul style="list-style-type: none"> Check and balance laundry load in the drum. Reduce the load.
EE	<ul style="list-style-type: none"> Water level sensor error. 	<ul style="list-style-type: none"> Contact the After sales service.
EE	<ul style="list-style-type: none"> High voltage protection. 	<ul style="list-style-type: none"> When the voltage is restored, the alarm is automatically cancelled and the machine runs normally.

8.3 Troubleshooting without display code

Problem	Cause	Solution
Washing machine fails to operate.	<ul style="list-style-type: none"> Programme is not yet started. Door is not properly closed. Machine has not been switched on. Power failure. Child lock is activated. 	<ul style="list-style-type: none"> Check programme and start it. Close the door properly. Switch the machine on. Check power supply. Deactivate child lock.
Washing machine will not be filled with water.	<ul style="list-style-type: none"> No water. Inlet hose is kinked. Inlet hose filter is blocked. Water pressure is less than 0.03 MPa. Door is not properly closed. Water supply failure. 	<ul style="list-style-type: none"> Check water tap. Check inlet hose. Unblock inlet hose filter. Check water pressure. Close the door properly. Ensure the water supply.
Machine is draining while being filled.	<ul style="list-style-type: none"> Height of drain hose is below 80 cm. Drain hose end could reach into water. 	<ul style="list-style-type: none"> Make sure that drain hose is properly installed. Make sure the drain hose is not in water.
Drainage failure.	<ul style="list-style-type: none"> Drain hose is blocked. Pump filter is blocked. Drain hose end is higher than 100 cm above floor level. 	<ul style="list-style-type: none"> Unblock drain hose. Clean pump filter. Make sure the drain hose is properly installed.
Strong vibration while spinning.	<ul style="list-style-type: none"> Not all transportation bolts have been removed. Appliance has no solid position. Machine load is not correct. 	<ul style="list-style-type: none"> Remove all transportation bolts. Ensure solid ground and a levelled position. Check load weight and balance.
Operation stops before completing wash cycle.	<ul style="list-style-type: none"> Water or electric failure. 	<ul style="list-style-type: none"> Check power and water supply.
Operation stops for a period of time.	<ul style="list-style-type: none"> Appliance displays error code. Problem due to load pattern. Programme performs soaking cycle. 	<ul style="list-style-type: none"> Consider display codes. Reduce or adjust load. Cancel programme and restart.
Excessive foam floats drum and/or detergent drawer.	<ul style="list-style-type: none"> Detergent is not appropriate. Excessive use of detergent. 	<ul style="list-style-type: none"> Check detergent recommendations. Reduce amount of detergent.

Problem	Cause	Solution
Automatic adjustment of washing time.	<ul style="list-style-type: none"> Washing programme duration will be adjusted. 	<ul style="list-style-type: none"> This is normal and doesn't affect functionality.
Spinning fails.	<ul style="list-style-type: none"> Unbalance of laundry. 	<ul style="list-style-type: none"> Check machine load and laundry and run a spinning programme again.
Unsatisfactory washing result.	<ul style="list-style-type: none"> Degree of pollution does not agree with selected programme. Detergent quantity was not sufficient. Maximum load has been exceeded. Laundry was unevenly distributed in the drum. 	<ul style="list-style-type: none"> Select an other programme. Choose the detergent according to the degree of pollution and according to manufacturer specifications. Reduce loading. Loose the laundry.
Washing powder residues are on the laundry.	<ul style="list-style-type: none"> Insoluble particles of detergent can remain as white spots on the laundry. 	<ul style="list-style-type: none"> Perform extra rinse. Try to brush the points from the dry laundry. Choose an other detergent.
Laundry has grey patches.	<ul style="list-style-type: none"> Caused by fats such as oils, creams or ointments. 	<ul style="list-style-type: none"> Pretreat the laundry with a special cleaner.

Note: Foam formation

If too much foam is inspected during spin cycle, motor stops and drain pump will be activated for 90 seconds. If that elimination of foam fails up to 3 times, programme ends without spinning.

Should the error messages reappear even after the taken measures, switch off the appliance, disconnect the power supply and contact the customer service.

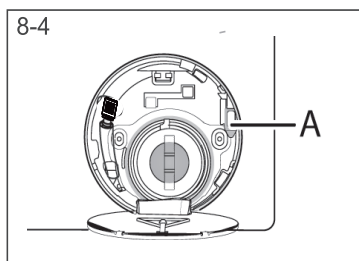

8.4 In case of power failure

The current programme and its setting will be saved. When power supply is restored operation will be resumed.

In case of power failure during programme run door opening is mechanically blocked. If the laundry is to be removed, the water level must not be visible in the glass door. -Danger of scalding!

- ▶ Lower the water level according to step 1 to 6 of chapter CARE AND CLEANING (PUMP FILTER).
- ▶ Pull lever (A) beneath service flap (Fig.8-4) until door is unlocked by a gentle click.
- ▶ Fix all parts and close the service flap.

9.1 Preparation

- ▶ Take the appliance out of the packaging.
- ▶ Remove all packing material including polystyrene base, keep them out of childrens reach. While opening the package, water drops may be seen on plastic bag and porthole.



Note: Packaging disposal

Keep all packaging materials out of children’s reach and dispose them in an environmentally friendly manner.

9.2 OPTIONAL: Adjusting the bottom cover board

When opening the package, you will find a bottom cover .The board is used for reducing noise after covering the bottom of the cabinet.

1. Lay the washing machine down to its side, windows upwards, Bottom side towards operator.
2. Insert the Bottom plate into the cabinet, Then fixed with 2 screws to the cabinet on the window side. Finally set the machine upright again (Fig. 9-1).

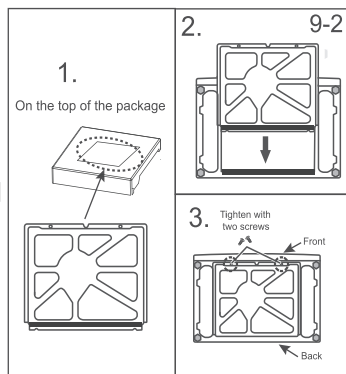

9.3 Dismantle the transportation bolts

The transportation bolts are designed for clamping anti-vibration components inside the appliance during transportation to prevent inner damage.

1. Remove the back cover.
2. Fill the 5 holes with blanking plugs (Fig. 9-2).

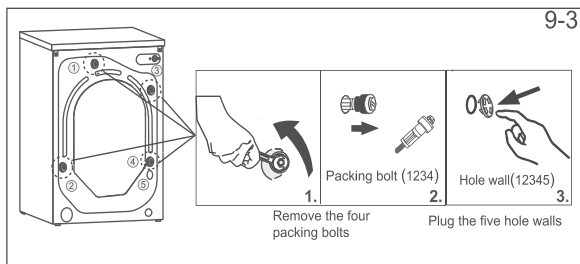

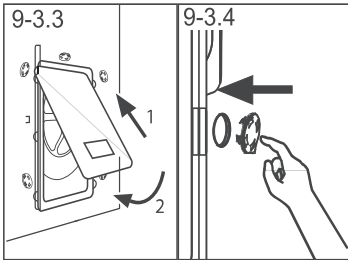

3. Replace back cover by inserting it in the two gaps its convexity is facing out (Fig. 9-3.3).
4. Fill left holes with blanking plugs (Fig. 9-3.4).



Note: Keep in safe place

Keep the transportation bolts in a safe place for later use. Whenever the appliance is to be moved at first reinstall the bolts.

9.4 Moving the appliance

If the machine is to be moved to a distant location, replace the transportation bolts removed before installation to prevent damage:

1. Remove the blanking plugs.
2. Remove the back cover.
3. Insert the plastic spacers and the transportation bolts.
4. Tighten the bolts with a spanner.
5. Replace the back cover.

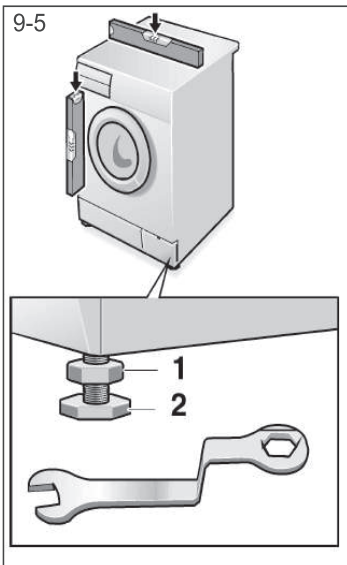

9.5 Aligning the appliance

Adjust all feet (Fig. 9-5) to achieve a complete level position. This will minimize vibrations and thus noise during use. It will also reduce wear and tear. We recommend to use a spirit level for adjustment. Floor should be as stable and flat as possible.

1. Loose the locknut (1) by using a wrench.
2. Adjust the high by turning the foot (2).
3. Tighten locknut (1) against the housing.

9.6 Drain Water Connection

Fix the water drain hose properly to the piping. The hose has to reach at one point a height between 80 and 100 cm above the appliance bottom line! If possible keep always drain hose fixed to the clip at the appliance back.



WARNING!

- ▶ Use only the supplied hose set for the connection.
- ▶ Never reuse old hose sets!
- ▶ Only connect to cold water supply.
- ▶ Before connection, check whether the water is clean and clear.

Following connections are possible:

9.6.1 Drain hose to sink

- ▶ Hang the drain hose with the U-support over the edge of a sink with adequate size (Fig. 9-6.1).
- ▶ Protect the U-support sufficiently against slipping.

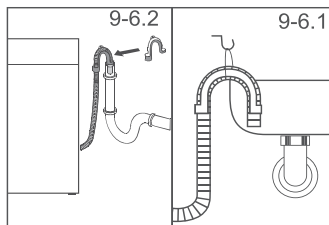

9.6.2 Drain hose to waste water connection

- ▶ The internal diameter of the stand pipe with vent-hole must be minimum 40 mm.
- ▶ Put the drain hose for approx. 80 mm in the waste water pipe.
- ▶ Attach the U-support and secure it sufficiently (Fig. 9-6.2).

9.6.3 Drain hose to sink connection

- ▶ The junction must lie above the siphon.
- ▶ A spigot connection is usually closed by a pad (A). That must be removed to prevent any disfunction (Fig. 9-6.3).
- ▶ Secure the drain hose with a clamp.

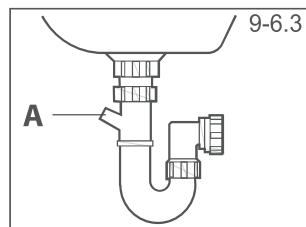

CAUTION!

- ▶ The Drain hose should not be submerged in water and should be securely fixed and leak-free. If the drain hose is placed on the ground or if the pipe is at a height of less than 80 cm, the washing machine will continuously drain while being filled (self-siphoning).
- ▶ Drain hose is not to be extended. If necessary contact after sales service.

9.7 Fresh Water Connection

Make sure that the gaskets are inserted.

1. Connect the water inlet hose with the angledend to the appliance(Fig.9-7.1).
2. Tighten the screw joint by hand (Fig.9-7.2).

Note- It is recommended to use inlet water filter to avoid strains and dirt to enter into the washing machine running operation. It helps to avoid water inlet valve blockage which causes E4 error.

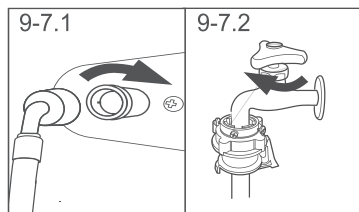

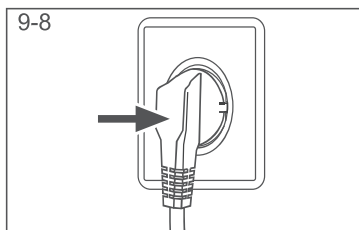

9.8 Electrical Connection

Before each connection check if:

- ▶ power supply, socket and fusing are appropriate to the rating plate.
- ▶ the power socket is earthed and no multi-plug or extension are used.
- ▶ the power plug and socket are strictly according.

Put the plug into the socket (Fig. 9-8).



WARNING!

- ▶ Ensure always that all connections (power supply, drain and fresh water hose) are firm, dry and leak free!
- ▶ Take care these parts are never to be crushed, kinked, or twisted.
- ▶ If the supply cord is damaged, it must be replaced by the service agent (see warranty card) in order to avoid a hazard.



Note: Drum Clean / Self Clean

After each installation or long periods of disuse, before first use and for regular maintenance run programme Self Clean with no load and small amount of detergent in washing agent compartment (2) or with special machine cleaner to remove possibly corrosive residues.

10.1 Additional technical data

	HW105-B14959S8U1
Voltage in V	220 V~/50Hz
Current in A	10
Max. power in W	1800
Water pressure in MPa	$0.03 \leq P \leq 1$
Netto weight in kg	70

10.2 Product dimensions

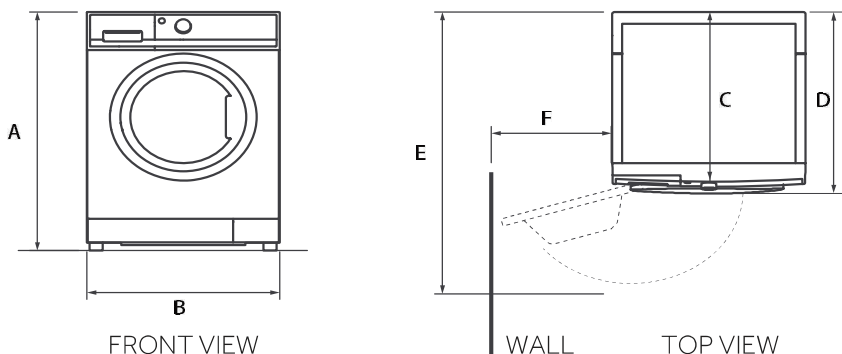

PRODUCT DIMENSIONS	HW105-B14959S8U1
A Overall height of product mm	850
B Overall width of product mm	595
C Overall depth of product (To main control board size) mm	508
D Overall depth of product mm	583
E Depth of door open mm	1045
F Minimum door clearance to adjacent wall mm	300

Note: The exact height of your washer is dependent on how far the feet are extended from the base of the machine. The space where you install your washer needs to be at least 40mm wider and 20mm deeper than its dimensions.

What is E-Waste or Electronic Waste?

Electronic waste @ e-waste is a term which refers to unusable, discarded and old, electric & electronic appliances such as refrigerators, LED/LCD/CTV, microwave oven, washing machines, home air conditioner, etc. As per E-waste (Management and Handling) Rules, 2016 e-waste 'e-waste' means electrical and electronic equipment, whole or in part discarded as waste by the consumer or bulk consumer as well as rejects from manufacturing, refurbishment and repair processes has been categorized into three main categories, i.e., Consumer Electronics/Home appliances and IT & Telecom. Refrigerators, washing machines, home air conditioner LED/LCD, etc. represents Consumer Electronics /home appliances. On the other hand computers, desktop, laptop mobile phones, etc. and its component represents Telecom & IT.

E-waste broadly covers waste from all electronic and electrical appliances and contains different hazardous materials which are harmful to human health and the environment if not disposed of carefully. While some naturally occurring substances are harmless in nature, their use in the manufacture of electronic equipment often results in compounds which are hazardous for example chromium becomes chromium VI. Thus Ministry of Environment, Forest & Climate Change, Govt. of India had listed issued directions for the reduction in the use of hazardous substances in the manufacture of electrical and electronic equipment and their components or consumables or parts or spares. The Ministry of Environment, Forest & Climate Change, Govt. of India in furtherance of its effort to reduce the hazard occurring from rapid growth in the Consumer durable and IT-Telecom market had made rules called as E-Waste (Management and Handling) Rules, 2016 under Environment Protection Act.

HAZARDS OF IMPROPER HANDLING AND/OR IMPROPER RECYCLING OF ELECTRONIC WASTE

Electronic equipment contains many hazardous metallic contaminants such as lead, cadmium, and beryllium and brominated flame-retardants. An improper handling and/or improper recycling of the Electronic Waste results in these hazardous metals/substances getting released into our eco and biological system, thereby leading to various health hazards. The Hazardous contents in the electronic equipment include:

Health:- The informal method of recycling extended health hazards. For example, primary and secondary exposure to toxic metals, such as lead, results generally from open-air burning used to retrieve valuable components such as gold.

Incineration from burning e-waste creates fine particulate matter, which is linked to pulmonary and cardiovascular disease.

Environment:- The informal method of recycling extended environment hazards too. For example when different e-waste is burnt to extract metals from it, toxic chemicals are released into the air, damaging the atmosphere.

- Lead • Brominated Flame Retardants • Chromium • Mercury • Beryllium • Cadmium • Barium • Carbon Black • Phosphor

E WASTE TOXIC COMPONENT & THEIR DAMAGE TO HUMAN HEALTH

Toxic Materials	Birth Defects	Brain Damage	Heart, Liver, Lung & Spleen Damage	Kidney Damage	Nervous/ Reproductive System Damage	Skeletal System Damage
Barium		X	X			
Cadmium			X			
Lead	X			X	X	X
Lithium	X	X		X	X	
Mercury	X	X	X	X	X	
Nickel	X	X	X	X		
Palladium	X		X	X		
Rhodium	X		X	X	X	
Silver		X	X			

Without safe recycling, most of these toxic components will end in land fill-poisoning soil and water.

The Dos of Electronic Waste Recycling:

1. Give the discarded Electronic Equipments only at the authorized collection centres so that the same can be properly recycled
2. Drop the discarded Electronic Equipments only in the bins meant for the Electronic Waste
3. Consult the authorized service centre as to whether the Electronic Equipment can be repaired or not, before discarding the same
4. Tell your neighbours and other persons about the hazards of improper disposal or handling or improper recycling of the Electronic Waste
5. If the unwanted Electronic Equipment still work or can be repaired then consider donating them

The Don'ts of Electronic Waste Recycling:

1. Don't dump the discarded Electronic Equipment in open or in any Land Fill Site as the same will result in contaminating the Soil and the groundwater
2. Don't dispose of the discarded Electronic Equipment in household bins or Municipal Bins
3. Don't sell or give your discarded Electronic Equipment to any Trash Dealer or Kabadiwala
4. Recycling Electronic equipment helps to save natural finite resources and also reduces the environmental and health risks associated with improper handling/disposing of the Electronic Waste
5. To minimize our impact on the earth and to protect the environment for future generations return your discarded Electronic Equipment here for safe recycling:

Why proper handling and management of e-waste is required?

According to MoEF, the electrical and electronic equipment (EEE) have valuable materials and hazardous/toxic substances in their components. The electronic products and electrical equipment after their useful life may not cause any harm if it is stored safely in households/stores. However, if the E-waste is opened-up and attempts are made for the retrieval of useful components or material in an unscientific manner or if the material is disposed of in open, then it may cause health risks and damage to the environment. E-waste can be considered as a resource that contains useful material of economic benefit for recovery of plastics, iron, glass, aluminum, copper and precious metals such as silver, gold, platinum, and palladium and lead, cadmium, mercury, etc. However, at the same time presence of heavy metals (As, Cd, Hg, Pb, etc.) and other toxic substances such as polychlorinated biphenyls (PCBs), etched chemicals, etc. may pose risk to health and environment during handling and recovery operations. E-waste is a problem of increasing proportions especially when crude methods are adopted for the recovery of useful components from E-waste. Thus, there is a need to encourage the recycling of all useful and valuable material from e-waste so as to conserve the ever depleting natural resources. The electronic component is increasingly made from recycled materials, for example for making new LCDs, more than 50% of indium is sourced by recycling used LCDs. The E-waste thus presents a scenario of urban mining for recovery of ferrous/non-ferrous/rare earth metal and precious metal in addition to plastics and glass. However, the presence of hazardous and toxic substances in the component of e-waste necessitates environmentally sound management of e-waste including collection and recycling/treatment in an environmentally sound manner.

Management and Effect on sustainable future:-

Sustainable development as defined by Brundtland Commission is "development that meets the needs of the present without compromising the ability of future generations to meet their own needs. The e-waste since a long time had been seen as an easy and cheapest source of metals. However, due to the lack of proper consideration for such a source of metals as well as proper methods of recycling in India, we sent our e-waste to the improper channel and thereby participated in degrading the environment. Moreover, through this improper method of extraction of metals we till date had wasted at least forty percent of the precious metals and simultaneously caused damage to our environment. If we opt the proper way to extract metals through proper channels of recycling then we can achieve Ninety percent of the extraction rate of our metals as well as a better way to save our environment. However, if today while selling off our material to the improper channel we will not think about our sustainable future then it is for sure that the coming generations will be facing crisis of the metals.

Customer/end-user responsibility

1. Consumers shall ensure that their end of life product/e-waste is channelized through collection center or dealer of the authorized producer or dismantler or recycler or through the designated take-back service provider of the producer to authorized dismantler or recycler;
2. Consumers shall ensure that such end-of-life electrical and electronic equipment are not admixed with e-waste containing radioactive material:

Bulk Consumer Responsibility:-

1. Bulk consumers of electrical and electronic equipment shall ensure that e-waste generated by them is channelized through collection center or dealer of authorized producer or dismantler or recycler or through the designated take-back service provider of the producer to authorized dismantler or recycler;
2. Bulk consumers of electrical and electronic equipment shall ensure that such end-of-life electrical and electronic equipment are not admixed with e-waste containing radioactive material as covered under the provisions of the Atomic Energy Act, 1962 (33 of 1962) and rules made thereunder;
3. Bulk consumers of electrical and electronic equipment listed in Schedule I shall maintain records of e-waste generated by them in Form-2 and make such records available for scrutiny by the concerned State Pollution Control Board;
4. Bulk consumers of electrical and electronic equipment listed in Schedule I shall file annual returns in Form-3, to the concerned State Pollution Control Board on or before the 30th day of June following the financial year to which that return relates;
5. In case of the bulk consumer with multiple offices in a State, one annual return combining information from all the offices shall be filed to the concerned State Pollution Control Board on or before the 30th day of June following the financial Year to which that return relates.

Haier's Responsibility

Haier India being a responsible and trustworthy brand is taking all the necessary and expected steps for the betterment of the environment as well as living beings. Haier had joined hands with a number of recyclers to ensure environment-friendly recycling of the electronic items, such as refrigerators, washing machines, air conditioners, etc. that are either achieved their end of life or are old, unusable, etc. Apart from above, Haier had taken the following steps for proper recycling of e-waste of its customers:-

1. Collection and Channelization of e-waste:- Haier had setup toll free Number where the customers can call and registered their products for recycling. As soon as e-waste pick up is registered by the customer a representative will come to collect the product.
2. Dismantling & Recycling of e-waste:- Haier has appointed a number of recyclers who are the leading name in the recycling industry to responsibly and in an environment-friendly manner recycle the e-waste generated in India.
3. Awareness for e-waste:- Haier is actively sharing Infographics & engagement posts on its social platforms to create more awareness about e-waste and its hazards. In addition Haier is also conducting awareness programs in Schools, RWA's, Office Clusters etc to create awareness.

Collection Centre maintained by M/s WEEE- PRO Resource Recovery Solutions Private Limited (as on date)

STATE	ADDRESS	CONTACT PERSON	CONTACT NUMBER
Andhra Pradesh	Shop No.5, New Gayawaka, Opp. High School Road, Andhra Pradesh-530026,	Mr. Jugli	955308577
Assam	HR-34 Kundli Nagar Basistha Chaital Near Pathari Apartment/Guwahaati-781029	Mr. Sishram	9864048000
Chhattisgarh	Map No 7, Ring Road No 2 Kabir Nagar Raigar Chhattisgarh	Mr. Bijender Singh	9303906097
Gujarat	Shop No D-9, Pusth Tenament, Behind Momy Hotel, Banpur Gujarat - 382443	Mr. Sandeep	9375688099
Haryana	J-171, New Palan Vihar Phase-I, Gurgaon, Haryana 120017	Mr. Rajesh	9711563229
Jammu & Kashmir	1 Sisco Chuk Bar Baramulla Jammu - 181133 Jammu & Kashmir Jammu-181133	Mr. Dhairamajal	9622565431
Jharkhand	A-26, Curia House, Nagar Hotel Amber Satchi Jamsheipur Jharkhand - 833101	Mr. Niraj	9304002777
Karnataka	No-43, 1st Floor 2nd Main D.D. U.T.T.L, Yeswanthpur Karnataka 560022	Mr. Rotan Lal	9886250346
Kerala	Door No- 84D SPW Road, Windlass Ln, Choochikkal, Kochi, Kerala - 683106, Kochi/Kochi, Kerala - 683106	Mr. Manish	9037991199
Madhya Pradesh	ZAR, A-3 Scheme No-78, Vijay Nagar MP	Mr. Yogesh	9302734152
Maharashtra	Plot No. 52, Gali No. - 01 Sector 19C, Vashliwan Mumbai -400705	Balwan Singh	9372168159 9371644600
	Shop 3, Kachone Complex, Amravati Road, Wadkhanna Maharashtra - 443003	Balwan Singh	9860814787
	Plot No. 24, Sector-4, Shilshah Colony Near Spine City, Mohali, Punjab/Karnal Maharashtra 412105	Balwan Singh	9370939911

STATE	ADDRESS	CONTACT PERSON	CONTACT NUMBER
New Delhi	Plot No. 61B, Block A, Near Tata Teles. Service Station, Rangpur, Mahipalpur Delhi - 110037	Rajkumar Poonia	9810053907
Orissa	1st Floor Delta House Rajendra Nagar, Mathura, Orissa, Orissa	Mr. Nihar Mahapatra	9337902236
Punjab	Shop No. -15 A, 16, Pathal Road, Opp - Tennis Academy, Zrakpur, Punjab-146003	Mr. Sanjeev	9316166155
Rajasthan	Plot No.RT, 2001 B, By Pass Near Ajmer Road, Harsipura, Rajasthan - 302021	Mr. Yogesh Saharan	9309413301
Tamil Nadu	327 Sakthi Garden Phase II, Sennerkuppam, Ponnamalai, Near Sider Water Park, Tamil Nadu - 600056	Mr. Firoj Khan	9385166155 9362005006
Telangana	Shop No. 4, Block-3-4th Shutter at 179 MP Estates Near Old Check Post, Secunderabad, Telangana - 500011	Mr. Ajay	9385166155 9396166155
Uttar Pradesh	S-177, Transport Nagar, Near RTO Office Lucknow UP-226012	Anuj Poojia	9336168155 9305166155
	Bh -12, Sector 70 Noida UP-201301	Anuj Poojia	9999166155
West Bengal	156A/73, Northam Park, B.T. Road DUNLOPWB - 700108	Mr. Vinod Kumar	9331522530
	R K Enterprise, Block Singha, West Bengal 842629	Mr Navad	8027329259



Contact for further information:
Haier Appliances (India) Pvt. Ltd.
Building Number 1, Okhla Industrial Estate,
Phase III, Opposite Modi Mill, New Delhi-110020.

Toll-Free Hotline Number
1800-102-9999
1800-419-9999

Query Between
9.00 AM to 9.00 PM
(Monday to Saturday)
Email- customer-care@haierindia.com

Our PRO Partners (E-waste Partner) (as on date)

1. M/s WEEE- PRO RESOURCE RECOVERY SOLUTIONS PRIVATE LIMITED
Address - Flat-702, Tower-6, Unitech Horizon, Plot No.-6, Sector P1-2, Greater Noida, Gautam Buddha Nagar, Uttar Pradesh, India, 201310
Contact Details - Mr. Bhagwati Prasad Suman - 9956445900 ; info@weee-pro.org; 1800-572-2961
2. PEGASUS SUSTAINABILITY PRIVATE LIMITED
Address - F-6, 1ST FLOOR, 46/41, 21, ANSARI ROAD, DARYAGANJ, New Delhi, Delhi, 110002
Contact: Mr. Subratoo Mukherjee ; 9811707777; <http://www.pegasusnetwork.in> in 1800-420-3177
3. M/s Green Planet
Address - 17D, 105, Vasundhara, Gaziabad 201012
Contact Details - Mr. Anish Duggal; 9212503521; <http://greenplanetpro.in/> in 1800 8430 027

Customer Name..... Address.....
 Serial No.....Date of purchase.....Model No.....
 Dealer Seal.....

HAIER WARRANTY

HAIER APPLIANCES (INDIA) PVT. LTD. (hereinafter referred to as “the Company”) hereby offers the following warranty to the original domestic purchaser commencing from the date of the purchase. The Company, at its sole discretion, will free of charge repair or replace any defective part or parts which prove to be defective in workmanship and/or materials and not due to abnormal or improper usage.

CONDITIONS OF WARRANTY

- 1) This warranty will automatically terminate on the expiry of the warranty period from the date of delivery.
- 2) The Company is not liable for any delay in servicing due to reasons beyond the control of the Company or any of its authorised service centres.
- 3) Parts replaced or repaired under this warranty are warranted throughout the remaining of the original warranty period.
- 4) It is entirely left to the Company’s discretion to repair/replace parts at the site of installation or at the authorised service centre of the Company.
- 5) This warranty shall be strictly limited to the repairs or replacement of defective parts specified in the warranty. This warranty shall not cover any consequential or resulting liability.
- 6) This warranty shall not, in any case, extend towards payment of any monetary consideration whatsoever or replacement or return of the product.
- 7) The Company may repair/supply parts free of cost during the warranty period. This warranty does not cover any Excise duty, Central or Sales tax, Octroi and other local taxes or levies on the components/parts.
- 8) The parts shall be replaced by functionally operating equivalent material only and not with brand new ones and are likely to be different from the one originally fitted. The parts thus removed shall be taken back by the Company.
- 9) The Company reserves the right to retain any part or component replaced at its sole discretion during the warranty period.
- 10) In no event the Company or its authorised service centre be liable for any consequential damages or resulting liability, damage or loss arising directly or indirectly out of any defect in the product.
- 11) This warranty is not valid in case of the following events:
 - a) If the Product has been Installed/Service/Repaired/Opened or Tampered by any unauthorised personnel.
 - b) If defects arise/caused by accidents, alteration, misuse, neglect, substitution of original components with spurious/non-genuine components, attacked by household pest / rodents, fire, flood, earthquake, lightning and/or any other act of God/natural calamities.
 - c) The product is shifted outside India.
- 12) (a) For any service under this warranty beyond city/town/municipal limits from the Company/authorised service centre, a fixed charge of Rs. 50 will be collected from the customer in addition to the actual to and fro charges by the shortest route
 (b) Service charges applicable after expiry of comprehensive warranty.
- 13) Any change of location or change in the ownership during the warranty period must be intimated in writing to the Company.
- 14) The Company’s employees or its authorised representatives have no authority to vary the terms of this warranty.
- 15) This warranty is effected in New Delhi and claims, if any, shall be made only before the courts having jurisdiction in New Delhi and no claim shall be made against the Company outside New Delhi notwithstanding that the Appliance may have been sold or delivered elsewhere.

WARRANTY		
Product	Period	Part not covered
HW105-B14959S8U1	Comprehensive-60 Months Motor-240 Months	Plastic Parts, Top Lid, Drain Pipe, Inlet Pipe, Lint Filter, Magic Filter



HAIER APPLIANCES (INDIA) P. LTD., Building No -1, Okhla Industrial Estate, Phase-III, New Delhi-110020
 Tel. : 011-39496000, 30674000, fax : 011-30674088, Website : www.haier.com/in

Customer Name..... Address.....
 Serial No.....Date of purchase.....Model No.....
 Dealer Seal.....





Haier