

User manual Washing machine

HW70-DM14959 Series
HW75-DM14959 Series
HW80-DM14959 Series
HW85-DM14959 Series
HW90-DM14959 Series



QR Code to directly chat with customer care executive.
(Customer Care WhatsApp No.: +91 8553049999)

Haier

WIFI Content Couplet

For U1 Series Models:

Download and Install Haier Smart APP

Scan the instruction page QR code with your mobile phone to download and install Haier Smart APP client.

Registration and Login

Connect to the home Wi-Fi, open the Haier Smart APP, register an account and log in, click the "+" symbol in the upper right corner, select the washing machine, select the corresponding model, and press and hold the Power button until C5 appears on the washing machine interface, and then connect the phone to Wi-Fi called "U WM", the washing machine automatically associates with the mobile phone to complete the binding.



Registration is required only the first time you use the APP, For further use, you only have to enter the user name and password to use the APP when successfully registered.

Function of APP

Equipment control: Select program mode, set program parameters, start program mode, pause, shutdown, etc.

Status View: View the running status of the device in real time.

Information reception: receiving various prompts such as fault alarm, etc.



The APP function will be updated continuously with the upgrade of the version, which is subject to the actual function of the corresponding version.



In the shutdown state, long press the Power button for 9 seconds, the display will show C5, then continue to hold the operation, the display will show U ON, indicating that Wi-Fi is on; on the contrary, In the shutdown state, long press the Power button for 9 seconds, the display will show C5, then continue to hold the operation, the display will show U OFF, indicating that Wi-Fi is off,



QR Code for WIFI application installation

Thank you for purchasing a Haier Product.

Please read these instructions carefully before using this appliance. The instructions contain important information which will help you get the best out of the appliance and ensure safe and proper installation, use and maintenance.

Keep this manual in a convenient place so you can always refer to it for the safe and proper use of the appliance.

If you sell the appliance, give it away, or leave it behind when you move house, make sure you also pass this manual so that the new owner can become familiar with the appliance and safety warnings.

Legend



Warning – Important Safety information



General information and tips



Environmental information

Disposal



Help protect the environment and human health. Put the packaging in applicable containers to recycle it. Help to recycle waste of electrical and electronic appliances. Do not dispose appliances marked with this symbol with the household waste. Return the product to your local recycling facility or contact your municipal office.



WARNING!

Risk of injury or suffocation!

Disconnect the appliance from the mains supply. Cut off the mains cable and dispose of it. Remove the door catch to prevent children and pets to get closed in the appliance.

Content

1-Safety information.....	4
2-Product description.....	7
3-Control panel.....	8
4-Programmes.....	11
5-Daily use.....	12
6-Eco-friendly washing.....	17
7-Care and cleaning.....	18
8-Troubleshooting.....	21
9-Installation.....	24
10-Technical data.....	28
11-After-sale service.....	29

1-Safety information

Before switching on the appliance for the first time read the following safety hints!



WARNING!

Before first use

- ▶ Make sure this is not transport damage.
- ▶ Make sure all transport bolts are removed.
- ▶ Remove all packing and keep out of children's reach.
- ▶ Handle the appliance always with at least two persons because it is heavy.

Daily use

- ▶ This appliance can be used by children aged from 8 years and above and persons with reduced physical, sensory or mental capabilities or lack of experience and knowledge if they have been given supervision or instruction concerning use of the appliance in a safe way and understand the hazards involved.
- ▶ Keep away children under 3 years of age from the appliance unless they are constantly supervised.
- ▶ Children shall not play with the appliance.
- ▶ Do not let children or pets come close to the appliance when the door is open. Store washing agents out of reach of children.
- ▶ Pull up zips, fix loose threads and take care for small items to prevent laundry from being entangled. If necessary, use an appropriate bag or net.
- ▶ Do not press or use the appliance when barefoot or with wet or damp hands or feet.
- ▶ Do not cover or encase the appliance during operation or afterwards to allow any moisture or dampness to evaporate.
- ▶ Do not place heavy objects or sources of heat or damp on top of the appliance.
- ▶ Do not use or store flammable detergent or dry cleaning agent in close vicinity to the appliance.
- ▶ Do not use any flammable sprays in close vicinity to appliance.
- ▶ Do not wash any garments treated with solvents in the appliance without having dried them previously in the air.

1-Safety information



WARNING!

Daily use

- ▶ Do not remove or inset the plug in the presence of flammable gas.
- ▶ Do not hot wash foam rubber or sponge-like materials.
- ▶ Do not wash any laundry which is polluted with flour.
- ▶ Do not open detergent drawer during any wash cycle.
- ▶ Do not press the door during the washing process, it gets hot.
- ▶ Do not open the door if the water level is visibly over the port hole.
- ▶ Do not force the door to open. The door is fitted with a self-lock device and will open shortly after the washing procedure is ended.
- ▶ Switch off the appliance after each wash programme and before undertaking any routine maintenance and disconnect the appliance from the electricity supply to save electricity and for safety.
- ▶ Hold the plug, not the cable, when unplugging the appliance.

Maintenance/cleaning

- ▶ Make sure children are supervised if they carry out cleaning and maintenance.
- ▶ Disconnect the appliance from the electrical supply before undertaking any routine maintenance.
- ▶ Keep the lower part of the porthole clean and open door and detergent drawer if appliance is not in use to prevent odours.
- ▶ Do not use water spray or steam to clean the appliance.
- ▶ Replace a damaged supply cord only by the manufacturer, its service agent or similarly qualified persons in order to avoid a hazard.
- ▶ Do not try to repair the appliance by yourself. In case of repair please contact our customer service.

Installation

- ▶ The appliance should be placed in a well-ventilated place. Ensure a location which allows opening the door fully.
- ▶ Never install the appliance outdoors in a damp place, or in an area which may be prone to water leaks such as under or near a sink unit. In the event of a water leak cut power supply and allow the machine to dry naturally.



WARNING!

Installation

- ▶ Install or use the appliance only where the temperature is above 5 °C.
- ▶ Do not place the appliance directly on a carpet, or close to a wall or furniture.
- ▶ Do not install the appliance in direct sunlight or in the near of heat sources (e.g. stoves, heaters).
- ▶ Make sure that the electrical information on the rating plate agrees with the power supply. If it does not, contact an electrician.
- ▶ Do not use multi-plug adapters and extension cables.
- ▶ Make sure only the delivered electric cable and hose set are used.
- ▶ Make sure not to damage the electric cable and the plug. If damaged have it replaced by an electrician.
- ▶ Use a separate earthed socket for the power supply which is easily accessible after installation. The appliance must be earthed.
- ▶ Make sure the hose joints and connections are firm and there is no leakage.

Intended use

This appliance is intended for washing machine-washable laundry only. Anytime follow the instructions given on the label of each garment label. It is not intended for commercial or industrial use.

Changes or modifications to the device are not allowed. Unintended use may cause hazards and loss of all warranty and liability claims.

2-Product description

Note:

Due to technical changes and different models, the illustrations in the following chapters may differ from your model.

2.1 Picture of appliance

Front (Fig. 2-1):



- 1 Detergent/Softener drawer
- 2 Worktop
- 3 Control panel
- 4 Door
- 5 Filter cover
- 6 Adjustable feet

Rear side (Fig. 2-2):

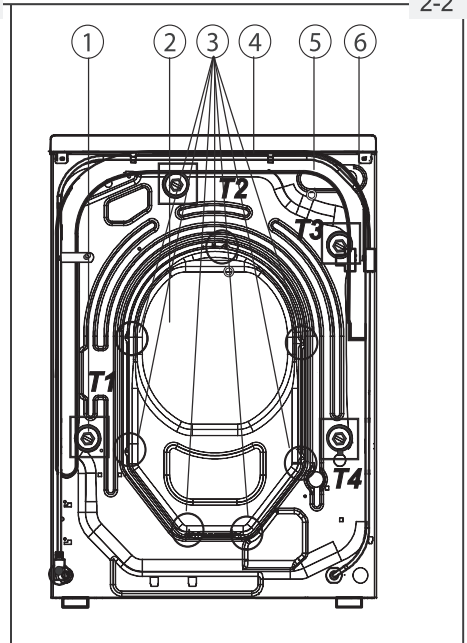

- 1 Transportation bolts (T1-T4)
- 2 Backcover
- 3 Backcover screws (7 EA)
- 4 Power cord
- 5 Drain hose
- 6 Water inlet valve

2.2 Accessories

Check the accessories and literature in accordance with this list (Fig. 2-3):

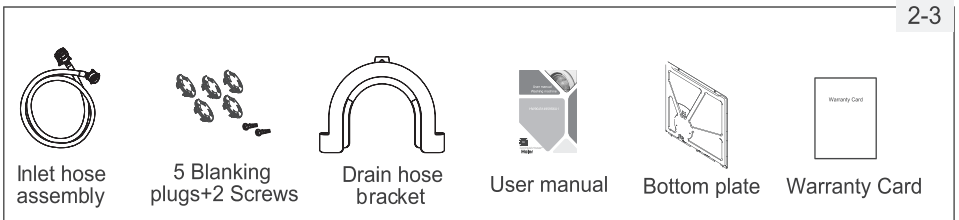

3-Control panel

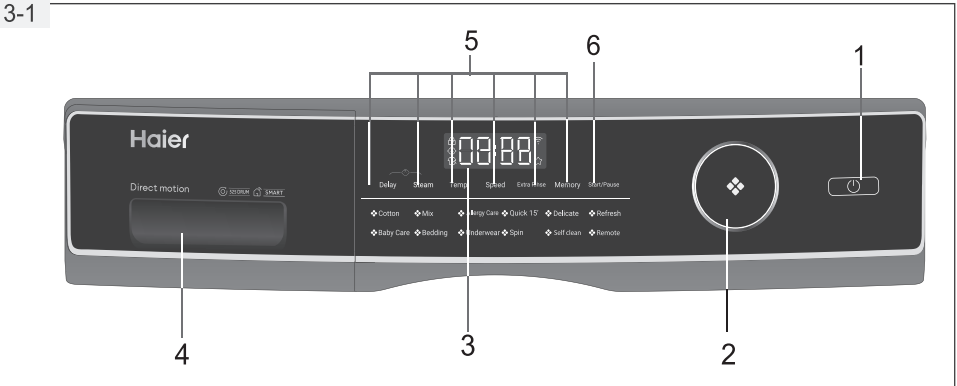

- | | | |
|----------------------|-------------------------------|------------------------|
| 1 "Power" button | 3 Display | 5 Function buttons |
| 2 Programme selector | 4 Detergent / Softener drawer | 6 "Start/Pause" button |

Note : Acoustic signal

In following cases an acoustic signal sounds:

- ▶ when pressing a button
- ▶ at the end of programme
- ▶ when selecting the programme
- ▶ in case of failures

The acoustic signal can be deselected if necessary; see DAILY USE.

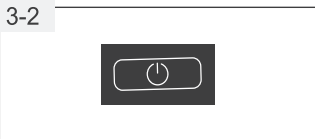

3.1 "Power" button

Touch this button (Fig.3-2) gently to switch on, the display is shining, Press it again for about 2 seconds to switch off. If no panel element or programme is activated after a while machine will shut down automatically.

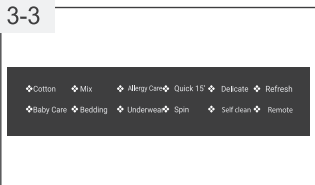

3.2 Programme selector

By turning the knob (Fig. 3-3), one of 12 programmers can be selected, related LED will light up.



3.3 Display

The display (Fig. 3-4) shows following information:

- ▶ Washing time
- ▶ End time delay
- ▶ Favorites
- ▶ Locking the door
- ▶ Child lock

3-Control panel

3.4 Detergent drawer

Open the drawer, two compartments can be seen (Fig. 3-5):

1 Compartment 1: Powder or Liquid detergent for programme.

2 Compartment 2: Softener, Conditioning agent etc. The recommendation on the type of detergents is suitable for the various washing temperatures, please refer to the manual of detergent.

This model does not have a disinfection washing program, and disinfectant can not be added to the disinfection washing inlet.

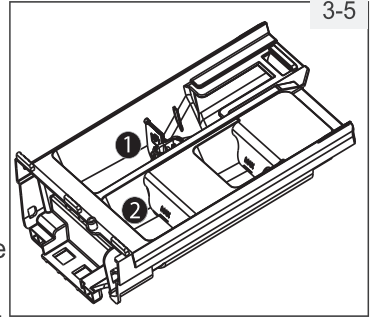

3.5 Function buttons

The function buttons (Fig. 3-6) enable additional options in the selected programme before programme starts. The related indicators are displayed.

If a button has multiple options, the desired option can be selected by touching the button sequentially.



i Note: Factory settings

To get best results in each programme Haier has well defined specific default settings. If there is no special requirement default settings are recommended.

3.5.1-Function button "Delay"

Press this button (Fig.3-7) to start the programme with a delay. End time delay could be increase in steps of 30 minutes from 0.5-24h. When you select the delay, the total time will default to longer than the programme run time. For example, display off 6:30 means end of programme cycle will be in 6 hours and 30 minutes. Press "Start/Pause" button to activate the time delay.

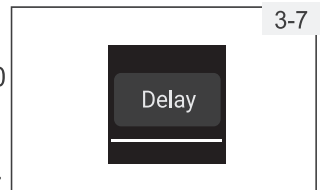

3.5.2-Function button "Temp."

Press this button (Fig. 3-9) to change the washing temperature of the programme. If no value is illuminated the water will not be heated.

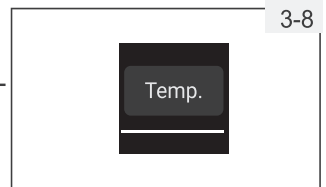

3-Control panel

3-9

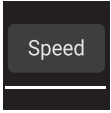

3.5.3 Function button “Speed”

Press this button (Fig. 3-9) to change or deselect the spin of the programme. If no value is illuminated the laundry will not spun.

3-10



3.5.4 “Extra Rinse” button

Press this button (Fig. 3-10) to rinse the laundry more intense with fresh water. This is recommended for people with sensitive skin.

By touching the button several times zero to two additional cycles can be selected. They appear in the display with P--0/P--1/P--2. Different extra rinsing times can be selected for different programs.



Note:Liquid detergent

If using liquid detergent, it is not recommended to activate the end time delay.

3-11

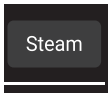

3.5.5 “Steam” button

Press this button (Fig 3-11) to select the steam programme, then the current programme temperature value will be changed to the maximum allowed value. The maximum temperature value can be viewed on the page of the parameters table in the manual. You can select if you require this function when programmes “Cotton, Synthetics, Mix, Baby care, Daily ” are used. The icon will light up when using the steam wash function.

3-12



3.6 “Start/Pause” button

Press this button (Fig. 3-12) gently to start or interrupt the currently displayed programme.

3-13

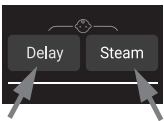

3.7 Child lock

Press button “Delay” and “Steam” (Fig. 3-13) for 3 seconds simultaneously to all panel elements against activation. For unlocking please touch again the two buttons. The child lock indicator lights up when the child lock works. This feature is optional when the machine is running.

3-14



The display shows clol- (Fig. 3-14) if a button will be pressed that means the child lock is activated. The change is not running.

4-Programmes

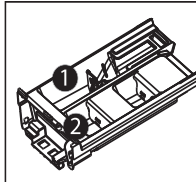

Detergent compartment for:

① Detergent

② Softener or care product

o Optional, / No

Programme	Max. load in kg	Temperature 1) in °C selectable range	Preset			Fabric type	Preset spin speed in rpm	Function		
				1	2			Steam	Extra Rinse	Delay
Cotton	9	* to 90	30	o	o	Cotton	1000	o	o	o
Mix	9	* to 60	30	o	o	Lightly soiled mixed- laundry of cotton and synthetic	1000	o	o	o
Allergy Care	4.5	* to 90	60	o	o	Cotton	1000	o	o	o
Baby Care	4.5	* to 90	40	o	o	Cotton/ synthetics	1000	o	o	o
Bedding	4.5	* to 60	30	o	o	Cotton	1000	o	o	o
Remote	/	/	/	o	o	/	/	/	/	/
Underwear	2	* to 60	40	o	o	Underwear	1000	o	o	o
Delicate	2	* to 30	30	o	o	Delicate laundry and silk	600	/	o	o
Refresh 2)	1	/	/	/	/	Cotton/ synthetics	/	/	/	/
Quick 15 3)	2	* to 40	*	o	o	Cotton/ synthetics	1000	/	o	o
Spin	9	/	/	/	/	Non-fragile fabric	1000	/	/	/
Self Clean 4)	/	*90	90	/	/	/	/	/	/	/

1)*: Water is not heated up.

Choose 90°C wash temperature only for special hygienic requirements.

2) Only one piece of adult or bulky clothing can be washed, and up to three pieces of children's clothing

3) Reduce detergent amount because programme duration is short.

4) Do not use detergent instead of use a special machine cleaner.

4.1 BEE Programming:

For 959 Series:

Step 1: Select the "Cotton" programme.

Step 2: Select the Temp range to 60°C

Step 3: Press speed button for 5 sec.

Then start the programme for BEE programme.

5.1 Power supply

Connect the washing machine to a power supply (220V/50Hz; Fig. 5-1). Please refer also to section INSTALLATION.

5.2 Water connection

- ▶ Before connecting check the cleanliness and clarity of the water inlet.
- ▶ Turn on the tap (Fig. 5-2).

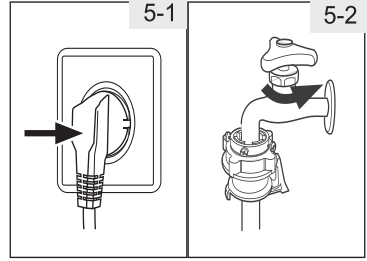

Note: Tightness

Before use check for leakage in the joints between the tap and the inlet hose by turning on the tap.

5.3 Preparing laundry

- ▶ Sort out clothes according to fabric (cotton, synthetics, wool or etc.) and how dirty they are (Fig. 5-3). Pay attention to the care labelling of washig labels.
- ▶ Separate white clothes from coloured ones. Wash coloured textiles first by hand to check if they fade or run.
- ▶ Empty pockets (keys, coins, etc.) and remove harder decorative objects (e.g. brooches).
- ▶ Garments without hems, delicates and finely woven textile such as fine curtains are to be put into a wash bag to care for this delicate laundry (hand or dry cleaning would be better).
- ▶ Close zippers, velco fastener and hooks, make sure the buttons are sewn on tightly.
- ▶ Place sensitive items like laundry without firm hem, delicate underwear and small items such as socks, belts, bras, etc. in a wash bag.
- ▶ Unfold large pieces of fabric such as bed sheets, bedspreads etc.
- ▶ Turn jeans and printed, decorated or color-intensive textiles inside out; possibly wash separately.

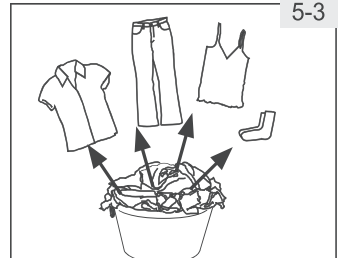











CAUTION!

Non-textile, as well as small, loose or sharp-edged items may cause malfunctions and damage of clothes and appliance.



5-Daily use

Care chart





Washing

 Washable up to 95°C normal process	 Washable up to 60°C normal process	 Washable up to 60°C mild process
 Washable up to 40°C normal process	 Washable up to 40°C mild process	 Washable up to 40°C very mild process
 Washable up to 30°C normal process	 Washable up to 30°C mild process	 Washable up to 30°C very mild process
 Wash by hand max. 40°C	 Do not wash	





Bleaching

 Any bleaching allowed	 Only oxygen/non-chlorine	 Do not bleach
--	--	---





Drying

 Tumble drying possible normal temperature	 Tumble drying possible lower temperature	 Do not tumble dryer
 Line drying	 Flat drying	

Ironing

 Iron at a maximum temperature up to 200°C	 Iron at a medial temperature up to 150°C	 Iron at a low temperature up to 110°C; without steam (steam ironing may cause irreversible damage)
 Do not iron		

Professional Textile Care

 Dry cleaning in tetra-chloroethene	 Dry cleaning in hydrocarbons	 Do not dry clean
 Professional wet clean	 Do not professional wet clean	

5.4 Loading the appliance

- ▶ Put in the laundry piece by piece.
- ▶ Don't overload. Note the different maximum load according to programmes! Rule of thumb for maximum load: Check if you can put a hand upright on top of load.
- ▶ Close the door carefully. Make sure that no pieces of laundry are pinched.

5.5 Selecting detergent

- ▶ Washing efficiency and performance is determined by used detergent quality.
- ▶ Use only machine wash approved detergent.
- ▶ If needed use specific detergents, e.g. synthetic and woolen fabric.
- ▶ Mind always detergent manufacturer recommendations.
- ▶ Do not use dry cleaning agents such as trichloroethylene and similar products.

Choose the best detergent

Programme	Kind of detergent				
	Universal	Colour	Delicate	Special	Softener
Cotton	√	√	-	-	√
Allergy Care	√	√	-	-	√
Baby Care	-	-	√	√	√
Remote	-	-	-	-	-
Delicate	-	-	√	√	√
Bedding	√P	√	-	-	√
Self Clean	-	-	-	√	o
Spin	-	-	-	-	-
Mix	√L	√	-	-	√
Quick 15'	√L	√L	-	-	√
Refresh	-	-	-	-	-
Underwear	-	-	√	√	√

L = gel-/liquid detergent P = powder detergent O = optional - = no
 √ = Recommended

If using liquid detergent, it is not recommended to activate the time delay.

We recommend by using:

- ▶ Laundry powder: 20°C to 90°C* (best use:40-60°C).
- ▶ Color detergent: 20°C to 60°C (best use:30-60°C).
- ▶ Wool/delicate detergent: 20°C to 30°C (best use:20-30°C).

* Choose 90°C wash temperature only for special hygienic requirements.

 It is better to use less or free suds detergent powder.

5-Daily use

5-4

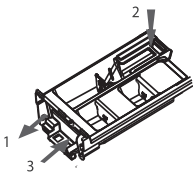

5.6 Adding detergent

1. Slide out the detergent drawer.
2. Put the required chemicals into corresponding compartments (Fig. 5-4).
3. Push back the drawer gently.

i Note:

- ▶ Remove detergent residues before next wash cycle from the detergent drawer.
- ▶ Do not overuse detergent or softener.
- ▶ Please follow the instruction on the detergent package.
- ▶ Always fill the detergent just before the beginning of the wash cycle.
- ▶ Concentrated liquid detergent should be diluted before adding into compartment 2.
- ▶ The best use of liquid detergent is by using a dosing ball, which is given with the laundry into the washing machine.
- ▶ Do not use liquid detergent if “end time delay” is selected.
- ▶ Carefully choose the programme settings according to the care symbols on all laundry labels and according to the programme table.

5-5

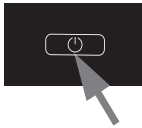

5.7 Switch on the appliance

Touch the “Power” button to switch on the appliance (Fig. 5-5).

5-6



5.8 Select a programme

To get the best washing results, select a programme which fits the degree of soiling and sort of laundry type.

Turn the programme knob (Fig. 5-6) to select the right programme.

i Note: Odour removal

Before first use we recommended to run programme Drum Clean with no load and small amount of detergent in washing agent compartment (2) or special machine cleaner to remove possibly corruptive residues.

5-7

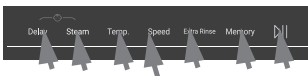

5.9 Add individual selections

Select required options and settings (Fig. 5-7); refer to CONTROL PANEL.

5.10 Start wash programme

Press “Start/Pause” button (Fig. 5-8) to start. Appliance operates according to present settings. Changes are only possible by cancelling the programme.

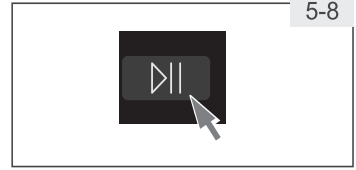

5.11 Interrupt / cancel wash programme

To interrupt a running programme press gently “Start/Pause”. The LED in the button is flashing. Press it again to resume operation.

To cancel a running programme and all its individual settings:

1. Press “Start/Pause” button to interrupt the running programme.
2. Turn the knob to select a new programme and start it.

5.12 After washing

i Note: Door lock

- ▶ For safety reasons the door is locked partially during the washing cycle. It is only possible to open the door at the end of the programme or after the programme was cancelled correctly (see description above).
- ▶ In case of high water level, high water temperature and during spinning it is not possible to open the door; **LoCk** is displayed.

1. At programme cycle end **End** is displayed.
2. The appliance switches off automatically.
3. Remove laundry as soon as possible to go easy on it and to prevent more wrinkling.
4. Turn off the water supply.
5. Unplug the power cord.
6. Open the door to prevent formation of moisture and odours. Let it open while not used. minutes before starting the programme or at the end of programme. The display switches off.

i Note: Standby mode / energy-saving mode

The switched on appliance will go into standby mode if it will not be activated within 2 minutes before starting the programme or at the end of programme. The display switches off.

5.13 Activate or deactivate the buzzer

The acoustic signal can be deselected if necessary:

1. Switch on the appliance.
2. Select the Drum Clean programme.
3. Press the “Extra rinse” button “Temp.” button and “Steam” button at the same time for about 3 seconds. **bEEP OFF** will be displayed and the buzzer will be deactivated. For activating the buzzer press these three buttons at the same time again, then **bEEP ON** will be displayed.

6-Eco-friendly washing



Environmentally responsible use

- ▶ To achieve best use of energy, water, detergent and time you should use the recommended maximum load size.
- ▶ Do not overload (hand width clearance above laundry).
- ▶ For slightly solid laundry select the Quick 15' programme.
- ▶ Apply exact dosages of each washing agent.
- ▶ Choose the lowest adequate washing temperature - modern detergents are efficiently cleaning below 60 °C.
- ▶ Raise default settings only due to heavy staining.
- ▶ Select max. spinning speed if a domestic dryer is used.

7-Care and cleaning

7.1 Cleaning the detergent drawer

Take always care there are no detergent residues. Clean the drawer regularly (Fig. 7-1):

1. Pull out the drawer until it stops.
2. Press there lease button and remove the drawer.
3. Flush the drawer with water until it is clean and insert the drawer back in the appliance.

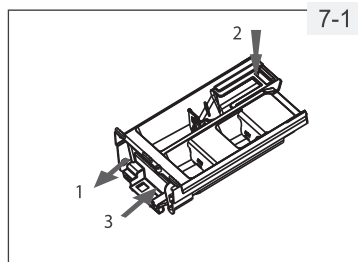

7.2 Cleaning the machine

- ▶ Unplug the machine during cleaning and maintenance.
- ▶ Use a soft cloth with soap liquid to clean the machine case (Fig. 7-2) and rubber components.
- ▶ Do not use organic chemicals or corrosive solvents.



7.3 Water inlet valve and inlet valve filter

To prevent blockage of water supply by solid substances like lime clean regularly the inlet valve filter.

- ▶ Unplug the power cord and turn off the water supply.
- ▶ Unscrew the water inlet hose at the back (Fig.7-3.1).
- ▶ Remove the filters and flush them with water and a brush (Fig.7-3.2).
- ▶ Insert the filter and install the inlet hose.

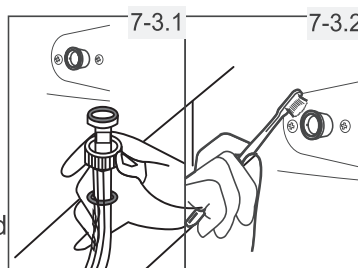

7.4 Cleaning the drum

- ▶ Remove accidentally washed metal parts such as pins, coins, etc. from the drum (Fig. 7-4) because they cause rust stains and damage.
- ▶ Use a non-chloride cleaner for removing rust stains. Observe the warning hints of the cleaning agent manufacturer.
- ▶ Do not use any hard objects or steel wool for cleaning.

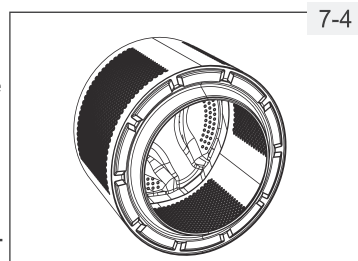

Note: Drum Clean

For regular maintenance we recommend to run programme Drum Clean with no load in order to remove possible corruptive residues quarterly. Add a small amount of detergent in washing agent compartment (2) - or use a special machine cleaner.

7-Care and cleaning

7-5.1

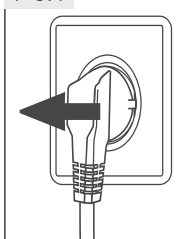

7-5.2

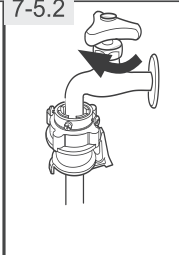

7.5 Long periods of disuse

If the appliance is left idle for a longer period:

1. Pull out the electrical plug (Fig. 7-5.1).
2. Turn off water supply (Fig. 7-5.2).
3. Open the door to prevent formation of moisture and odours. Let door open while not used.

Before next usage check carefully power cord, water inlet and drain hose. Make sure everything is properly installed and without leakage.



Note: Hygiene

After long periods of disuse we recommend to run programme Drum Clean with no load and small amount of detergent in washing agent compartment (2) or special machine cleaner to remove possibly corruptive residues.

7-6.1

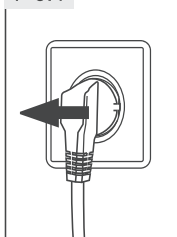

7-6.2

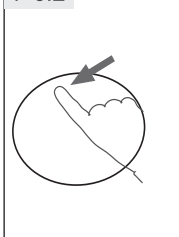

7.6 Pump filter

Clean the filter once a month and check the pump filter for instance if the appliance:

- ▶ Doesn't drain the water.
- ▶ Doesn't spin.
- ▶ Cause unusual noise while running.



WARNING!

Scalding Risk! Water in the pump filter can be very hot! Before any action please ensure water has cooled down.

7-6.3

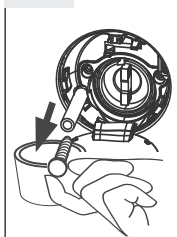

7-6.4

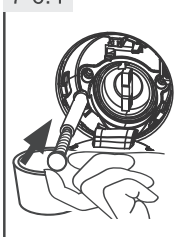

1. Turn off and unplug the machine (Fig. 7-6.1).
2. Open service flap (Fig. 7-6.2).
3. Provide a flat container to catch leach water (Fig. 7-6.3). There could be bigger amounts!
4. Pull the drain hose out and hold its end above the container (Fig. 7-6.3).
5. Take the sealing plug out of the drainhose (Fig. 7-6.3).
6. After complete drainage close drainhose (Fig. 7-6.4) and push it back into the machine.
7. Unscrew and remove counter clock wise the pump filter (Fig. 7-6.5).
8. Remove contaminants and dirt (Fig. 7-6.6).

7-6.5

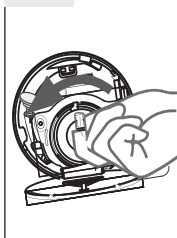

7-6.6

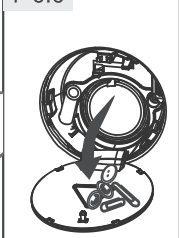

7-Care and cleaning

9. Clean carefully pump filter, e.g. using running water(Fig.7-6.7).
10. Refix it thoroughly(Fig.7-6.8).
11. Close service flap.

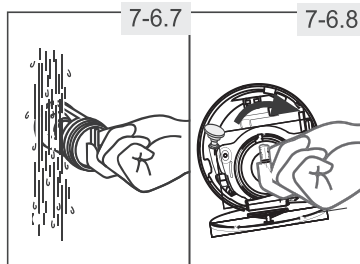

CAUTION!

- ▶ Pump filter sealing has to be clean and unhurt.If the lid is not full tightened, water can escape.
- ▶ The filter must be in place, or it may lead to leakage.

7.1 WIFI Activation And Usage

For 959 Series:

- Step 1: Scan below QR Code for app Download and install (available on manual also)
- Step 2: App Home Page
- Step 3: For User Login (For New Account Register).
- Step 4: Add Smart Product (WM)
- Step 5: Select Product
- Step 6: Select Model
- Step 7: Press "Power Button" 5 Seconds until the machine show C5
- Step 8: Click Blue Tick and Press Next
- Step 9: Mobile thru which App operated should be connected to same network as Machine.
- Step 10: Search same Wi-Fi network & input Wi-Fi password. Press Connect Network
- Step 11: Process start of Connecting Machine
- Step 12: If not connected, needs to do "Connect Manually"
- Step 13: After Connected, for using can Press "Use Immediately"
- Step 14: Complete Loading 100%.
- Step 15: Need to open Remote Authorization of Washing Machine.
- Step 16: Turn the Knob to Remote Function, to start operating through App.
- Step 17: Start using App, various Online Programs available.
Programs will update as per new feature addition through Wi-Fi application.

8-Troubleshooting

Many occurring problems could be solved by yourself without specific expertise. In case of a problem please check all shown possibilities and follow below instructions before you contact an after sales service. See CUSTOMER SERVICE.



WARNING!

- ▶ Before maintenance, deactivate the appliance and disconnect the mains plug from the mains socket.
- ▶ Electrical equipment should be serviced only by qualified electrical experts, because improper repairs can cause considerable consequential damages.
- ▶ A damaged power cable should only be replaced by the manufacturer, its service agent or similarly qualified persons in order to avoid a hazard.

8.1 Information codes

Following codes are displayed only for information referring to the washing cycle. No measures must be performed.

Code	Message
00:25	The remaining wash cycle time will be 1 hour and 25minutes.
06:30	The remaining wash cycle time including chosen end-time delay will 6 hours and 30 minutes.
0000	The washing cycle is finished. The appliance shuts off automatically.
0000	Function child lock is activated.
0000	Door is closed because of high water level, high water temperature or spinning cycle.
0000 00	The buzzer is activated.
0000 000	The buzzer is deactivated.

8.2 Troubleshooting with display code

Problem	Cause	Solution
000 0000	• Drainage error, water is not fully drained within 6 minutes.	• Clean pump filter. • Check drain hose installation.
00	• Lock error.	• Shut the door properly.
00	• Water level not reached after 8 minutes, at the latest. • Drain hose is self-syphoning.	• Make sure that tap is fully opened and water pressure is normal. • Check drain hose installation.
00	• Water protective level error.	• Contact the After sales service.
00	• Temperature sensor error.	• Contact the After sales service.
00	• Heating error.	• Contact the After sales service.

8-Troubleshooting

Problem	Cause	Solution
EE	<ul style="list-style-type: none"> • Motor error. 	<ul style="list-style-type: none"> • Contact the After sales service.
EE8 or EE2	<ul style="list-style-type: none"> • Abnormal communication error. 	<ul style="list-style-type: none"> • Contact the After sales service.
EE8	<ul style="list-style-type: none"> • Unbalanced load error. 	<ul style="list-style-type: none"> • Check and balance laundry load in the drum. Reduce the load.
EE	<ul style="list-style-type: none"> • Water level sensor error. 	<ul style="list-style-type: none"> • Contact the After sales service.
EE	<ul style="list-style-type: none"> • High voltage protection. 	<ul style="list-style-type: none"> • When the voltage is restored, the alarm is automatically cancelled and the machine runs normally.

8.3 Troubleshooting without display code

Problem	Cause	Solution
Washing machine fails to operate.	<ul style="list-style-type: none"> • Programme is not yet started. • Door is not properly closed. • Machine has not been switched on. • Power failure. • Child lock is activated. 	<ul style="list-style-type: none"> • Check programme and start it. • Close the door properly. • Switch the machine on. • Check power supply. • Deactivate child lock.
Washing machine will not be filled with water.	<ul style="list-style-type: none"> • No water. • Inlet hose is kinked. • Inlet hose filter is blocked. • Water pressure is less than 0.03 MPa. • Door is not properly closed. • Water supply failure. 	<ul style="list-style-type: none"> • Check water tap. • Check inlet hose. • Unblock inlet hose filter. • Check water pressure. • Close the door properly. • Ensure the water supply.
Machine is draining while being filled.	<ul style="list-style-type: none"> • Height of drain hose is below 80 cm. • Drain hose end could reach into water. 	<ul style="list-style-type: none"> • Make sure that drain hose is properly installed. • Make sure the drain hose is not in water.
Drainage failure.	<ul style="list-style-type: none"> • Drain hose is blocked. • Pump filter is blocked. • Drain hose end is higher than 100 cm above floor level. 	<ul style="list-style-type: none"> • Unblock drain hose. • Clean pump filter. • Make sure the drain hose is properly installed.
Strong vibration while spinning.	<ul style="list-style-type: none"> • Not all transportation bolts have been removed. • Appliance has no solid position. • Machine load is not correct. 	<ul style="list-style-type: none"> • Remove all transportation bolts. • Ensure solid ground and a levelled position. • Check load weight and balance.
Operation stops before completing wash cycle.	<ul style="list-style-type: none"> • Water or electric failure. 	<ul style="list-style-type: none"> • Check power and water supply.
Operation stops for a period of time.	<ul style="list-style-type: none"> • Appliance displays error code. • Problem due to load pattern. • Programme performs soaking cycle. 	<ul style="list-style-type: none"> • Consider display codes. • Reduce or adjust load. • Cancel programme and restart.
Excessive foam floats drum and/or detergent drawer.	<ul style="list-style-type: none"> • Detergent is not appropriate. • Excessive use of detergent. 	<ul style="list-style-type: none"> • Check detergent recommendations. • Reduce amount of detergent.

8-Troubleshooting

Problem	Cause	Solution
Automatic adjustment of washing time.	<ul style="list-style-type: none"> Washing programme duration will be adjusted. 	<ul style="list-style-type: none"> This is normal and doesn't affect functionality.
Spinning fails.	<ul style="list-style-type: none"> Unbalance of laundry. 	<ul style="list-style-type: none"> Check machine load and laundry and run a spinning programme again.
Unsatisfactory washing result.	<ul style="list-style-type: none"> Degree of pollution does not agree with selected programme. Detergent quantity was not sufficient. Maximum load has been exceeded. Laundry was unevenly distributed in the drum. 	<ul style="list-style-type: none"> Select an other programme. Choose the detergent according to the degree of pollution and according to manufacturer specifications. Reduce loading. Loose the laundry.
Washing powder residues are on the laundry.	<ul style="list-style-type: none"> Insoluble particles of detergent can remain as white spots on the laundry. 	<ul style="list-style-type: none"> Perform extra rinse. Try to brush the points from the dry laundry. Choose an other detergent.
Laundry has grey patches.	<ul style="list-style-type: none"> Caused by fats such as oils, creams or ointments. 	<ul style="list-style-type: none"> Pretreat the laundry with a special cleaner.

Note: Foam formation

If too much foam is inspected during spin cycle, motor stops and drain pump will be activated for 90 seconds. If that elimination of foam fails up to 3 times, programme ends without spinning.

Should the error messages reappear even after the taken measures, switch off the appliance, disconnect the power supply and contact the customer service.

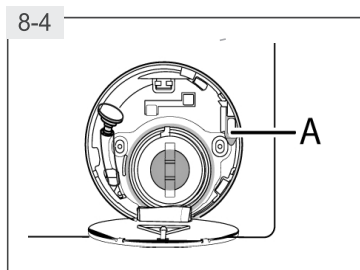

8.4 In case of power failure

The current programme and its setting will be saved. When power supply is restored operation will be resumed.

In case of power failure during programme run door opening is mechanically blocked. If the laundry is to be removed, the water level must not be visible in the glass door. -Danger of scalding!

- ▶ Lower the water level according to step 1 to 6 of chapter CARE AND CLEANING (PUMP FILTER).
- ▶ Pull lever (A) beneath service flap (Fig.8-4) until door is unlocked by a gentle click.
- ▶ Fix all parts and close the service flap.

9.1 Preparation

- ▶ Take the appliance out of the packaging.
- ▶ Remove all packing material including polystyrene base, keep them out of children's reach. While opening the package, water drops may be seen on plastic bag and porthole. This is a normal phenomenon results from water tests in the factory.



Note: Packaging disposal

Keep all packaging materials out of children's reach and dispose them in an environmentally friendly manner.

9.2 OPTIONAL: Adjusting the bottom cover board

When opening the package, you will find a bottom cover (A). The board is used for reducing noise after covering the bottom of the cabinet.

1. Lay the washing machine down to its side, windows upwards, Bottom side towards operator.
2. Insert the Bottom plate into the cabinet, Then fixed with 2 screws to the cabinet on the window side. Finally set the machine upright again (Fig. 9-1).

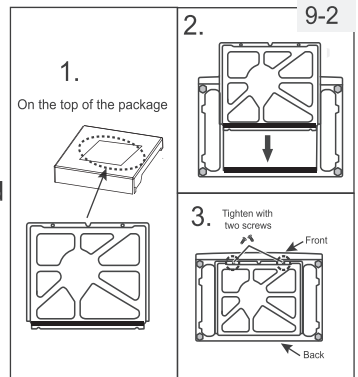

9.3 Dismantle the transportation bolts

The transportation bolts are designed for clamping anti-vibration components inside the appliance during transportation to prevent inner damage.

1. Remove the back cover.
2. Fill the 5 holes with blanking plugs (Fig. 9-2).

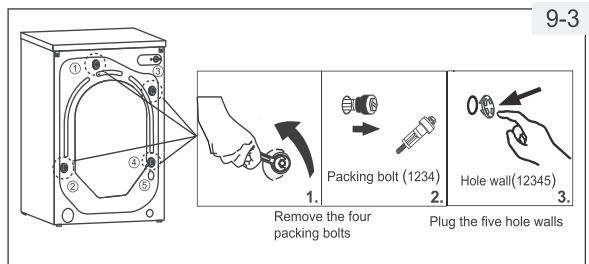

9-Installation

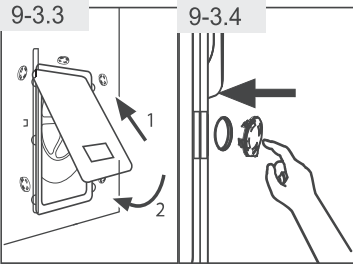

3. Replace back cover by inserting it in the two gaps its convexity is facing out (Fig. 9-3.3).
4. Fill left holes with blanking plugs (Fig. 9-3.4).



Note: Keep in safe place

Keep the transportation bolts in a safe place for later use. Whenever the appliance is to be moved at first reinstall the bolts.

9.4 Moving the appliance

If the machine is to be moved to a distant location, replace the transportation bolts removed before installation to prevent damage:

1. Remove the blanking plugs.
2. Remove the back cover.
3. Insert the plastic spacers and the transportation bolts.
4. Tighten the bolts with a spanner.
5. Replace the back cover.

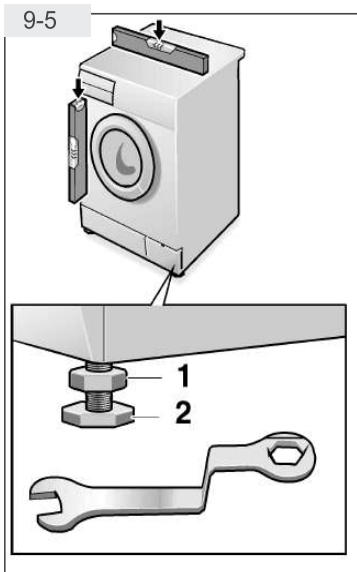

9.5 Aligning the appliance

Adjust all feet (Fig. 9-5) to achieve a complete level position. This will minimize vibrations and thus noise during use. It will also reduce wear and tear. We recommend to use a spirit level for adjustment. Floor should be as stable and flat as possible.

1. Loose the locknut (1) by using a wrench.
2. Adjust the high by turning the foot (2).
3. Tighten locknut (1) against the housing.

9.6 Drain Water Connection

Fix the water drain hose properly to the piping. The hose has to reach at one point a height between 80 and 100 cm above the appliance bottom line! If possible keep always drain hose fixed to the clip at the appliance back.



WARNING!

- ▶ Use only the supplied hose set for the connection.
- ▶ Never reuse old hose sets!
- ▶ Only connect to cold water supply.
- ▶ Before connection, check whether the water is clean and clear.

Following connections are possible:

9.6.1 Drain hose to sink

- ▶ Hang the drain hose with the U-support over the edge of a sink with adequate size (Fig. 9-6.1).
- ▶ Protect the U-support sufficiently against slipping.

9.6.2 Drain hose to waste water connection

- ▶ The internal diameter of the stand pipe with vent-hole must be minimum 40 mm.
- ▶ Put the drain hose for approx. 80 mm in the waste water pipe.
- ▶ Attach the U-support and secure it sufficiently (Fig. 9-6.2).

9.6.3 Drain hose to sink connection

- ▶ The junction must lie above the siphon.
- ▶ A spigot connection is usually closed by a pad (A). That must be removed to prevent any disfunction (Fig. 9-6.3).
- ▶ Secure the drain hose with a clamp.

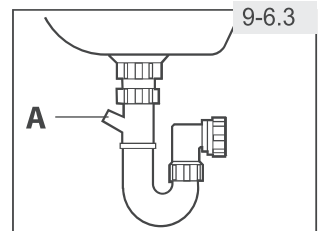
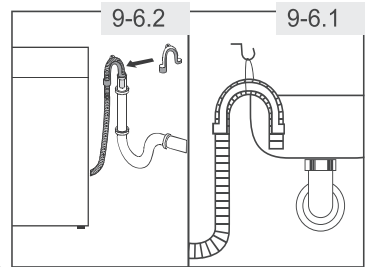

CAUTION!

- ▶ The Drain hose should not be submerged in water and should be securely fixed and leak-free. If the drain hose is placed on the ground or if the pipe is at a height of less than 80 cm, the washing machine will continuously drain while being filled (self-siphoning).
- ▶ Drain hose is not to be extended. If necessary contact after sales service.

9-Installation

9-7.1

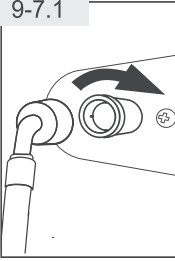

9-7.2

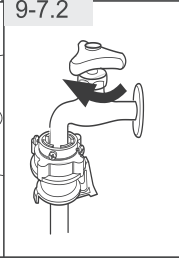

9.7 Fresh Water Connection

Make sure that the gaskets are inserted.

1. Connect the water inlet hose with the angled end to the appliance (Fig. 9-7.1).
2. Tighten the screw joint by hand (Fig. 9-7.2).

9-8

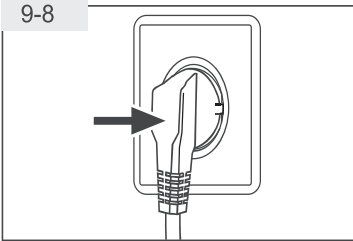

9.8 Electrical Connection

Before each connection check if:

- ▶ power supply, socket and fusing are appropriate to the rating plate.
- ▶ the power socket is earthed and no multi-plug or extension are used.
- ▶ the power plug and socket are strictly according.

Put the plug into the socket (Fig. 9-8).



WARNING!

- ▶ Ensure always that all connections (power supply, drain and fresh water hose) are firm, dry and leak free!
- ▶ Take care these parts are never to be crushed, kinked, or twisted.
- ▶ If the supply cord is damaged, it must be replaced by the service agent (see warranty card) in order to avoid a hazard.



Note: Drum Clean

After each installation or long periods of disuse, before first use and for regular maintenance run programme Drum Clean with no load and small amount of detergent in washing agent compartment (2) or with special machine cleaner to remove possibly cor-ruptive residues.

10.1 Additional technical data

Model Name	HW90-DM14959 Series; HW85-DM14959 Series HW80-DM14959 Series; HW75-DM14959 Series; HW70-DM14959 Series
Dimension height	850mm
Width	595mm
Depth	500mm
Power supply	220V/50Hz
Current	10A
Max. power	1800W
Water pressure	$0.03\text{MPa} \leq P \leq 1\text{MPa}$
Net weight	59kg
Max. spin speed	1400rpm

11-After-sale service

If after checking the trouble-shooting part, the problem is not solved. Please check the Warranty Card included in the product.

E-waste Guideline Manual



Introduction

We at Haier in our continuous efforts of making a future better adopted eco-friendly practices and procedures. We acting towards our social, moral and statutory responsibility towards the environment and sustainable development have pledged to recycle electronic items, such as TV/LED/LCD, refrigerator, washing machine, etc. that are no longer useful. Haier is stepping towards leading a more conservation and optimization of resources and thereby making environment safer. We request you to donate or utilize take back scheme for your electronic good when it reaches its end-of-life, so that it can be reuse -recycle and reinvent.

"Hazard of e waste on environment and Human Health :-"

The informal method of recycling extends health hazards. Primary and secondary exposure to toxic metals, such as lead, results in diseases like Heart, Liver, Lung & Spleen Damage. Open-air burning of electronic waste, used to retrieve valuable components such as gold, not only causes damages to environment but also to human health. Incineration from burning e-waste creates fine particulate matter, which is linked to heart and respiratory disease. However the above said is only example and the informal way to recycle causes numerous health hazards. During such informal recycling no caution or care are kept to either secure the environment or human health. The informal method of recycling extended environment hazards too. For example when different e-waste is burnt to extract metals from it, toxic chemicals are released in to the air, damaging the atmosphere. Such informal ways creates noise, water and air pollution.

E WASTE TOXIC COMPONENT & THEIR DAMAGE TO HUMAN HEALTH

Toxic Materials	Birth Defects	Brain Damage	Heart, Liver, Lung & Spleen Damage	Kidney Damage	Nervous/ Reproductive System Damage	Skeletal System Damage
Barium	✓	X	X	✓	✓	✓
Cadmium	X	✓	X	X	X	X
Lead	X	X	✓	X	X	✓
Lithium	X	X	X	X	X	✓
Mercury	X	X	X	X	✓	✓
Nickel	X	✓	X	X	X	✓
Palladium	X	X	X	X	✓	✓
Rhodium	✓	✓	X	✓	✓	✓
Silver	X	X	X	X	X	✓

Without safe recycling, most of these toxic components will end in land fill-poisoning soil and water

11-After-sale service

"Why proper handling and management of e-waste :-

The electrical and electronic equipment (EEE) have valuable materials and hazardous/toxics substances in their components. The electronic products and electrical equipment after their useful life may not cause any harm if it is stored safely in households/stores. However, if the E-waste is opened-up and attempts are made for retrieval of useful components or material in an un-scientific manner or if the material is disposed in open, then it may cause health risks and damage to environment. E-waste can be considered as a resource that contains useful material of economic benefit for recovery of plastics, iron, glass, aluminum, copper and precious metals such as silver, gold, platinum, and palladium and lead, cadmium, mercury etc. However, at the same time presence of heavy metals (As, Cd, Hg, Pb etc.) and other toxic substances such as polychlorinated biphenyls (PCBs), etched chemicals, etc. may pose risk to health and environment during handling and recovery operations. E-waste is a problem of increasing proportions especially when crude methods are adopted for recovery of useful components from E-waste.

Thus, there is a need to encourage OUR SELF for recycling of all useful and valuable material from e-waste so as to conserve the ever depleting natural resources. Electronic component are increasingly made from recycled materials, for example for making new LCDs, more than 50% of indium is sourced by recycling used LCDs. The E-waste thus presents a scenario of urban mining for recovery of ferrous/non-ferrous/ rare earth metal and precious metal in addition to plastics and glass. However, presence of hazardous and toxic substances in the component of e-waste necessitates environmentally sound management of e-waste including collection and recycling/treatment in an environmentally sound manner.

"Management and Effect on sustainable future:-

Sustainable development as defined by Brundtland Commission is "development that meets the needs of the present without compromising the ability of future generations to meet their own needs."

The e-waste since a long time had been seen as an easy and cheapest source of metals. However due to lack of proper consideration for such source of metals as well as proper methods of recycling in India, we sent our e-waste to the improper channel/scrap vendor and thereby participated in degrading the environment. Moreover, through this improper method of extraction of metals we till date had wasted approximately 40% of the precious metals and simultaneously caused damage to our environment. If we opt the proper way to extract metals through proper channel of recycling then we can achieve approximately 90% of extraction rate of our metals as well as a better way to save our environment. However, if today while selling off our material to improper channel we will not think about our sustainable future then it is for sure that the coming generations will be facing crisis of the metals.

Customer responsibility

- a) consumers shall ensure that their end of life product/e-waste is channelized through collection center or dealer of authorized producer or dismantler or recycler or through the designated take back service provider of the producer to authorized dismantler or recycler;
- b) consumers shall ensure that such end-of-life electrical and electronic equipment are not admixed with e-waste containing radioactive material;

Electronic Waste Recycling:

Do's

- Handover/Donate/Give the discarded Electronic Equipment's only at the authorized collection centers.
- Drop the discarded Electronic Equipment's only in the bins meant for the Electronic Waste.
- Ask the retailer about the Take Back schemes.
- Consult the authorized service center as to whether the Electronic Equipment can be repaired or not, before discarding the same.
- Tell your neighbors and other persons about the hazards of improper disposal or handling or improper recycling of the Electronic Waste.
- If the unwanted Electronic Equipment still work or can be repaired then consider donating them.
- To minimize our impact on the earth and to protect the environment for future generations return your discarded Electronic Equipment's here for safe recycling :

Don'ts

- Don't dump the discarded Electronic Equipment's in open or in any Land Fill Site as the same will result in contaminating the Soil and the ground water.
- Don't dispose of the discarded Electronic Equipment's in household bins or Municipal Bins.
- Don't sell or give your discarded Electronic Equipment's to any Trash Dealer or Kabadiwala/unauthorized vendor.
- Don't try to open up the product by yourself for repair or other purposes.
- Don't mix the electronic waste into household waste stream.
- Don't keep any replaced spare part(s) from the product in exposed area. Always handover such article to service personal so that same can be recycled.

Haier Appliances (India) Pvt. Ltd.
Building No. 1, Okhla Industrial Estate,
Phase III, New Delhi -110020
or Call us at
Toll Free No. (24X7) : 1800-419-9999, 1800-102-9999



Haier

0030516193E