



WASHING MACHINE

USER MANUAL

HW70-IM12929 Series

HW75-IM12929 Series

HW80-IM12929 Series

HW70-IM12929U1 Series

HW75-IM12929U1 Series

HW80-IM12929U1 Series

HW80-IM14979U1 Series

- Please read this manual carefully before using washing machine.
- Retain it for future reference.

For U1 Series Models:

Download and Install Haier Smart APP

Scan the instruction page QR code with your mobile phone to download and install Haier Smart APP client.

Registration and Login

Connect to the home Wi-Fi, open the Haier Smart APP, register an account and log in, click the "+" symbol in the upper right corner, select the washing machine, select the corresponding model, and press and hold the power button until C5 appears on the washing machine interface, and then connect the phone to Wi-Fi called "U WM", the washing machine automatically associates with the mobile phone to complete the binding.

i Registration is required only the first time you use the APP, For further use, you only have to enter the user name and password to use the APP when successfully registered.

Function of APP

Equipment control: Select program mode, set program parameters, start program mode, pause, shutdown, etc.

Status View: View the running status of the device in real time.

Information reception: receiving various prompts such as fault alarm, etc.

i The APP function will be updated continuously with the upgrade of the version, which is subject to the actual function of the corresponding version.

i In the shutdown state, long touch the power button for 9 seconds, the display will show C5, then continue to hold the operation, the display will show U ON, indicating that Wi-Fi is on; on the contrary, In the shutdown state, long touch the power button for 9 seconds, the display will show C5, then continue to hold the operation, the display will show U OFF, indicating that Wi-Fi is off,



QR Code for WIFI application installation

Thank you for purchasing a Haier Product.

Please read these instructions carefully before using this appliance. The instructions contain important information which will help you get the best out of the appliance and ensure safe and proper installation, use and maintenance.

Keep this manual in a convenient place so you can always refer to it for the safe and proper use of the appliance.

If you sell the appliance, give it away, or leave it behind when you move house, make sure you also pass this manual so that the new owner can become familiar with the appliance and safety warnings.

Legend



Warning – Important Safety information



General information and tips



Environmental information



1. Help protect the environment and human health.
2. Help to recycle waste of electrical and electronic appliances.
3. Do not dispose appliances marked with this symbol with the household waste.

For further information on environmental friendly disposal please visit ewaste manual @ attached with this document or visit https://www.haier.com/in/e-waste-guidelines/?spm=in.abouthaierin_pc.footer_bottom_20190530.3



WARNING!

Risk of injury or suffocation!

Disconnect the appliance from the main supply. Cut off the main cable and dispose of it. Remove the door latch to prevent the children and pets to trap inside drum during non operation of machine for long time.

1-Safety information.....	3
2-Before Use	6
3-Functions.....	10
4-Programmes.....	13
5-Daily use.....	15
6-Eco-friendly washing.....	20
7-Maintenance	21
8-Troubleshooting.....	24
9-Technical data.....	26
10-E-Waste Guideline	27
11-Warranty Terms	29

 **BRAND INTRODUCTION**

Haier Group—

Established in 1984, Haier Group is a world-leading provider of solutions to beautiful life. Haier has topped Euromonitor's World Home Appliance Brands and its subsidiary Haier Smart Home Co., Ltd. is among the Fortune Global 500 Companies. Thank you for purchasing Haier product.



Before switching on the appliance for the first time read the following safety hints!



WARNING!

Before first use

- ▶ Make sure there is no transit damage.
- ▶ Make sure all transit bolts are removed.
- ▶ Remove all packing material and keep out of reach of childrens.
- ▶ Handle the appliance always with atleast two persons because it is heavy in weight.

Daily use

- ▶ This appliance can be used by childrens aged from 8 years and above and persons with reduced physical, sensory or mental capabilities or lack of experience and knowledge if they have been given supervision or instructions concerning use of the appliance in a safe way and understand the hazards involved.
- ▶ Keep away from children under 3 years of age from the appliance unless they are constantly supervised.
- ▶ Childrens shall not play with the appliance.
- ▶ Do not let the children or pets come close to the appliance when the door of machine is open. Store washing agents away from the childrens.
- ▶ Pull up zips, fix loose threads and take care for small items to prevent laundry from being entangled. If necessary, use an appropriate bag or net.
- ▶ Do not start or use the appliance when you are barefoot or with wet or damp hands or feet.
- ▶ Do not cover or encase the appliance during operation or afterwards to avoid moisture or dampness to evaporate.
- ▶ Do not place heavy objects or sources of heat or damp cotton on the top of the appliance.
- ▶ Do not use or store flammable detergent or dry cleaning agent near to the appliance.
- ▶ Do not use any flammable sprays near to the appliance.
- ▶ Do not wash any garments treated with solvents in the appliance without having dried them in the air before wash.



WARNING!

Daily use

- ▶ Do not insert or remove the plug in presence of flammable gas.
- ▶ Do not wash foam rubber or sponge like materials.
- ▶ Do not wash any laundry which is polluted with flour.
- ▶ Do not open detergent drawer during any wash cycle.
- ▶ Do not press the door during the washing process as it gets hot.
- ▶ Do not open the door if the water level is visible over the port hole.
- ▶ Do not force the door to open after the washing process is ended. The door is fitted with a self-lock device and will open shortly.
- ▶ Switch off the appliance after wash programme and before doing any routine maintenance. Disconnect the appliance from the electrical supply to save electricity and for safety.
- ▶ Hold the plug when unplugging the appliance from electrical supply.

Maintenance/cleaning

- ▶ Make sure that children are supervised at the time of cleaning and routine maintenance.
- ▶ Disconnect the appliance from the electrical supply before doing any routine maintenance.
- ▶ Keep the lower part of the porthole clean. Open the door and the detergent drawer if appliance not in use to prevent odours.
- ▶ Do not use water spray or steam to clean the appliance.
- ▶ Replace a damaged supply cord only by the manufacturer or its service agent or similarly qualified persons in order to avoid any hazard.
- ▶ Do not try to repair the appliance by yourself. To repair the appliance, please contact our customer service.

Installation

- ▶ The appliance should be placed in a well ventilated place. Please ensure a location from which door shall be opens fully.
- ▶ Never install the appliance in a damp place, or in an area where is possibility of water leaks such as under or near a sink unit. In the event of a water leak, cut the power supply and dry the machine naturally.



WARNING!

Installation

- ▶ Install the appliance only where the temperature is above 5 °C.
- ▶ Do not place the appliance directly on a carpet, or close to a wall or furniture.
- ▶ Do not install the appliance in direct sunlight, or in the near of heat sources (e.g. stoves, heaters).
- ▶ Make sure that the electrical information on the nameplate agrees with the power supply. If not, contact an electrician.
- ▶ Do not use multi-plug adapters and extension board.
- ▶ Make sure that only delivered electric cable and hose set shall be used.
- ▶ Make sure that electrical cable and plug shall not be damaged, if yes, then it shall be replaced by an electrician.
- ▶ Use a separate earthed socket for the power supply which is easy accessible after installation. The appliance must be earthed.
- ▶ Make sure that the hose joints and connections are firm and there is no leakage.

Intended use

This appliance is intended for washing laundry only. Any time follow the instructions given on the label of each garment. It is not ntended for commercial or industrial use.

Changes or modifications in the device are not allowed. Unintended use may cause hazards and loss of all warranty and liability claims.



Note :

Due to technical changes and different models, the illustrations in the following pictures may differ from your model.

2.1 Picture of appliance

Front side (Fig. 2-1):

Rear side (Fig. 2-2):

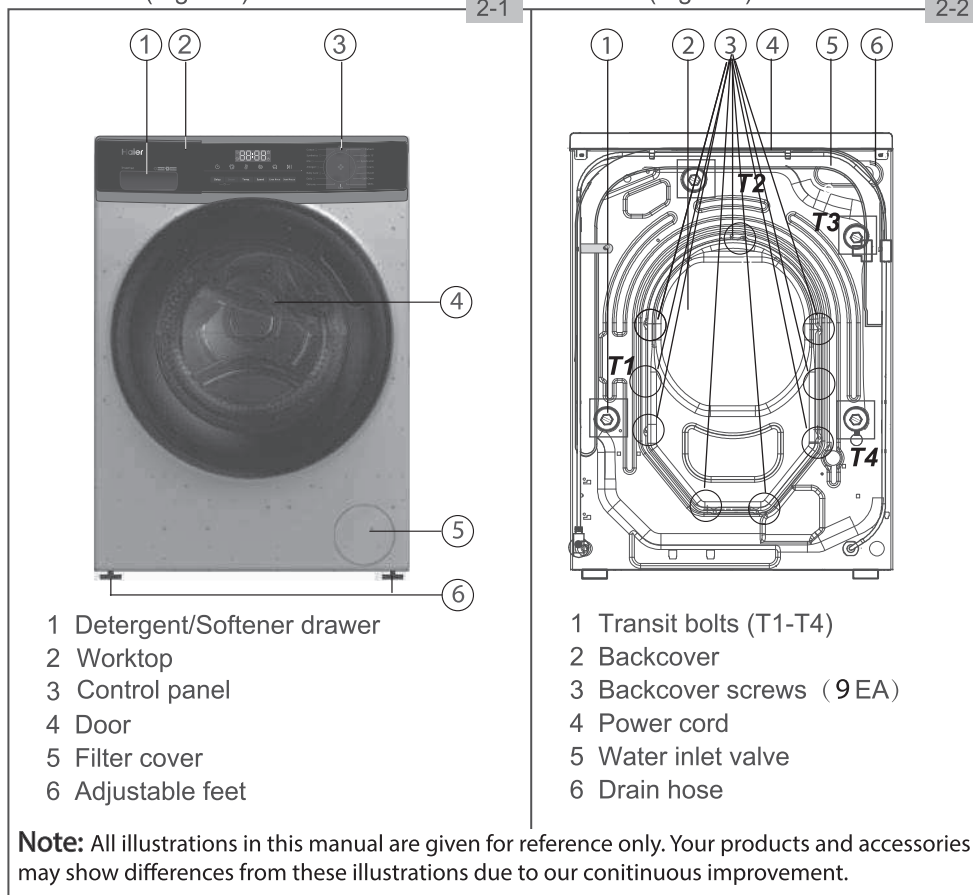

2.2 Accessories

Check the accessories and literature in accordance with this list (Fig.2-3):

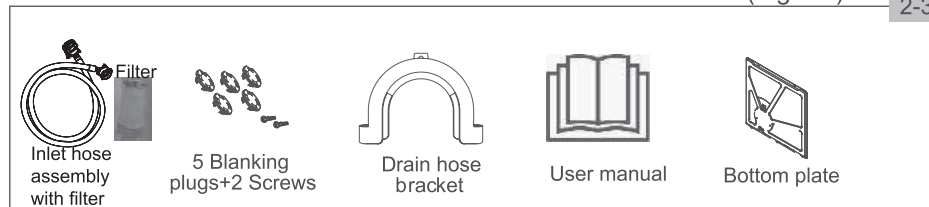

2.3 Preparation

- ☒ Take the appliance out from the packaging.
- ☒ Remove all packing material including polystyrene base, keep them away from the childrens. When removing the packaging, water drops may be seen on plastic bag and porthole. This normal phenomenon results from water tests in the factory.



Note: Packaging disposal

Keep all the packaging materials away from the childrens and dispose it in an environmentally friendly manner.

2.4 Installation of bottom cover board

When opening the package, you will find a bottom cover (2-4.1) The board is used for reducing the noise.

1. Lay down the washing machine to it's back side, bottom side towards the operator.
2. Insert the Bottom cover into the cabinet, then fixed with 2 screws to the cabinet front side. Then set the machine upright again (Fig.2-4).

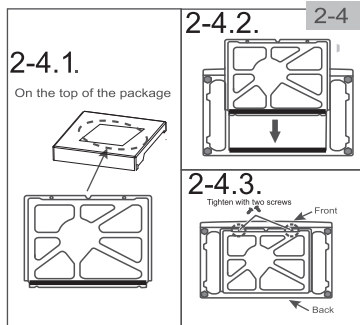

2.5 Dismantle the transit bolts

The transit bolts are designed to clamping the components inside the appliance during transportation to prevent inner damage.

1. Remove the transit bolts.
2. Fill the holes with blanking plugs (Fig.2-5).

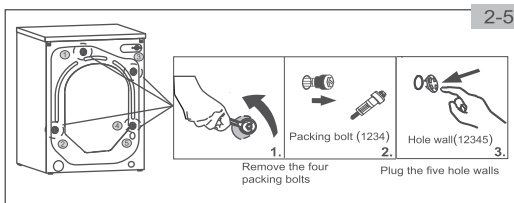

Note : Keep the transit bolts in a safe place

Keep the transit bolts in a safe place for later use. Whenever the appliance need to be moved to distant place, refix the transit bolts.



Note : Keep the transit bolts in a safe place

Keep the transit bolts in a safe place for later use. Whenever the appliance need to be moved to distant place, refix the transit bolts.

2.6 Moving the appliance

If the machine is to be moved to distant location, refix the transit bolts before moving the appliance to prevent damage.

1. Remove the blanking plugs.
2. Remove the back cover.
3. Insert the plastic spacers and the transit bolts.
4. Tighten the bolts with a spanner.
5. Refix the back cover.

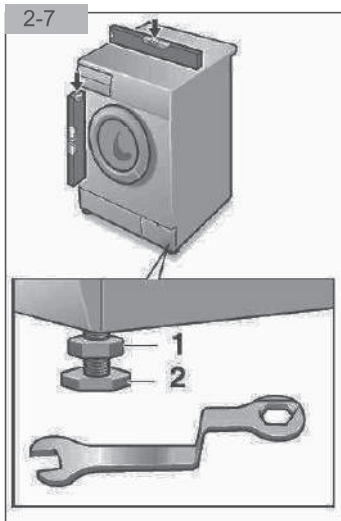

2.7 Aligning the appliance

Adjust all legs (Fig. 2-7) to achieve a complete level position. This will minimize vibrations and noise during use. It will also reduce wear and tear. We recommend to use a spirit level for levelling. Floor should be as stable and flat as possible.

1. Loose the locknut (1) by using a wrench.
2. Adjust the leg (2) by turning.
3. Tighten locknut (1) against the housing.

2.8 Drain Water Connection

Fix the water drain hose properly to the piping. The hose has to reach a height between 80 to 100 cm at a point above the appliance bottom line. If possible, keep always drain hose fixed to the clip at the appliance back.



WARNING!

- ▶ Use only the supplied hose set for the connection.
- ▶ Never reuse old hose sets.
- ▶ Only connect to cold water supply.
- ▶ Before connection, check whether the water is clean and clear.

Following connections are possible:

2.8.1 Drain hose to sink

- ▶ Hang the drain hose with the U-support over the edge of a sink with adequate size (Fig. 2-8.1).
- ▶ Protect the U-support sufficiently.

2.8.2 Drain hose to waste water connection

- ▶ The internal diameter of the stand pipe with vent-hole must be minimum 40 mm.
- ▶ Put the drain hose for approx. 80 mm in the Waste water pipe.
- ▶ Attach the U-support and secure it sufficiently (Fig. 2-8.2).

2.8.3 Drain hose to sink connection

- ▶ The junction must lie above the siphon.
- ▶ A spigot connection is usually closed by a pad (A). That must be removed to prevent any disfunction (Fig. 2-8.3).
- ▶ Fix the drain hose with a clamp.

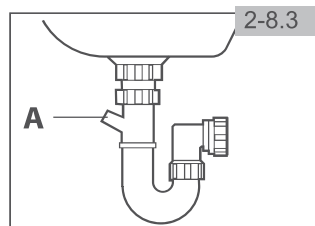
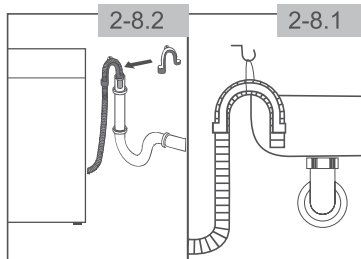



CAUTION!

- ▶ The Drain hose should not be submerged in water and should be securely fixed and leak-free. If the drain hose is placed on the ground or if the pipe is at a height of less than 80 cm, the washing machine will continuously drain while being filled (self-siphoning).
- ▶ Drain hose is not to be extended. If necessary contact service agent.

2-9.1

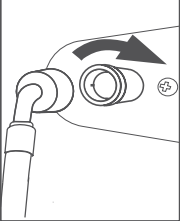

2-9.2

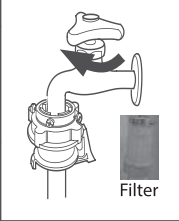

2.9 Fresh Water Connection

Make sure that the gaskets are inserted.

1. Connect the water inlet hose with the angled end to the appliance (Fig. 2-9.1). Tighten the joint by hand.
2. Connect the other end with water tap using filter. (Fig. 2-9.2)

Note- It is recommended to use inlet water filter to avoid strains and dirt to enter into the washing machine running operation. It helps to avoid water inlet valve blockage which causes E4 error.

2-10

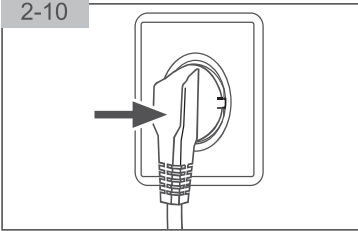

2.10 Electrical Connection

Before each connection check if:

- ▶ power supply, socket and fusing are appropriate to the nameplate.
- ▶ the power socket is earthed and no multi-plug or extension board are used.
- ▶ the power plug and socket are strictly according. Put the plug into the socket (Fig. 2-10).



WARNING!

- ▶ Ensure always that all connections (power supply, drain and fresh water hose) are firm, dry and leak free.
- ▶ Take care these parts are never to be crushed, kinked, or twisted.
- ▶ If the supply cord is damaged, it must be replaced by the service agent (see warranty card) in order to avoid a hazard.



Note: Self Clean

After each installation or long periods of disuse, before first use and for regular maintenance run the "Self Clean" programme with no load and small amount of detergent in "detergent drawer" compartment (2) or with special machine cleaner to remove possibly residues.

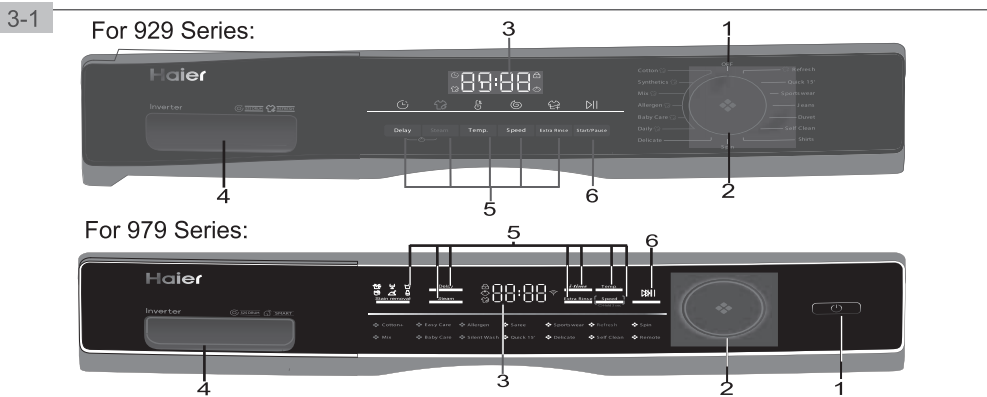

- | | | |
|-----------------------|-------------------------------|------------------------|
| 1 OFF/ "Power" button | 3 Display | 5 Function buttons |
| 2 Programme selector | 4 Detergent / Softener drawer | 6 "Start/Pause" button |

i Note : Acoustic signal

In following cases an acoustic signal sounds:

- when pressing a button
- at the end of programme
- in case of failures

The acoustic signal can be deselected if necessary; see DAILY USE.

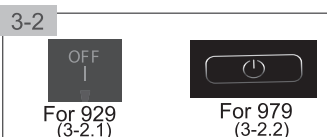

3.1 "Power" button

For 929 Series Models:

By turning the knob (Fig. 3-2.1), turn on knob to any position (except "OFF") to start the machine. Turn the knob to the OFF position to shut down the machine (Fig.3-2.2).

For 979 Series Models:

Touch the button (Fig.3-2.2) for 2 sec to "ON" and press for 2 sec to "OFF".

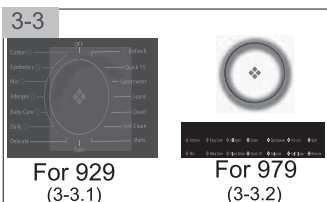

3.2 Programme Selector

For 929 Series Models:

By turning the knob (Fig. 3-3.1), one of programme (except OFF) can be selected out of 15.

For 979 Series Models:

By turning knob (Fig. 3-3.2), one of programme can be selected out of 14. Selected programme gets light up on display.



3.3 Display

The display (Fig.3-4) shows following information:

- Washing time
- End time delay
- Steam washing
- Door lock
- Child lock

i Note: Factory settings

To get best results in each programme Haier has well defined specific default settings. If there is no special requirement, default settings are recommended.

3.4 Detergent drawer

Two compartment can be seen after opening the drawer (Fig.3-5).

- 1: Compartment 1 for powder or liquid detergent.
- 2: Detergent flap selector 2, lift it up for powder detergent, keep it down for liquid detergent.
- 3: compartment 3 for sanitizer.
- 4: compartment 4 for softner.
- 5: Lock tab, press it down to pull out dispenser drawer.

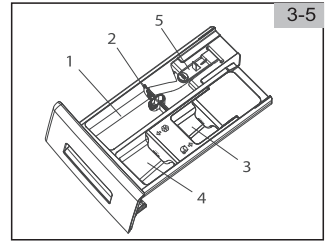

3.5 Functions buttons

The Function buttons (Fig.3-6) enabled additional options in the selected programme before programme starts. The related indicators are displayed.

If button has multiple options, the desired option can be selected by touching button sequentially. (In 929 Series). By touching the buttons, when it is in dull light, programme is unselected; when it is in bright light, function is selected. (In 979 series).

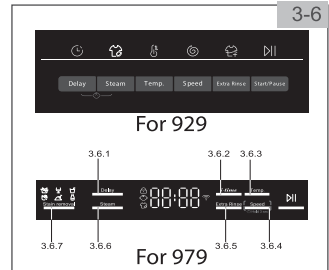

3.5.1-Function button “Delay”

Press this button (Fig.3-7) to start the programme with a delay. End time delay could be increase in steps of 30 minutes from 0.5-24h. When you select the delay, the total time will default longer than the programme run time. For example, display off 6:30 means end of programme cycle will be in 6 hours and 30 minutes. Press “Start/Pause” button to activate the time delay.(In 929 & 979 series).

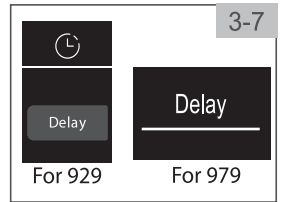

3.5.2

Function button “Temp”

Press this button (Fig.3-8) to change the washing temperature of the programme. If no value is illuminated, the water will not be heated. (For 929 Series)

Touch this button (Fig.3-8) to change the washing temperature of the programme. If no value display on screen then water will not get heated. (For 979 Series).

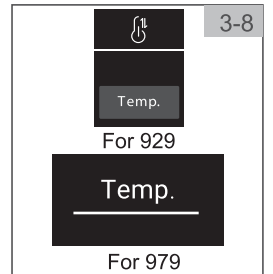

3.5.3 Function button “Speed”

Press or touch this button Fig.(3-9) to change or deselect the spin of the program. If no value is shown, the laundry will not spin. (For 929 & 979 Series).

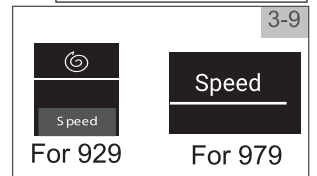

i Note:Liquid detergent

If using liquid detergent, it is not recommended to activate the end time delay.

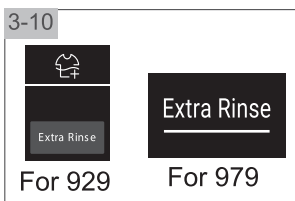

3.5.4 “Extra Rinse” button

Press this button (Fig. 3-10) to rinse the laundry more intense with fresh water. This is recommended for people with sensitive skin.

By touching the button several times, 0 to 2 additional cycles can be selected. They will appear in the display with P--0/P--1/P--2. (For 929 & 979 Series).

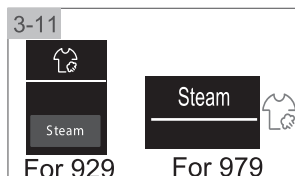

3.5.5 “Steam” button

Press this button Fig.(3-11) to select steam programme, then current will reach to maximum allowed value. Maximum temp value can be viewed from the manual. You can select steam function for “Cotton, Synthetic, Mix, Baby care, Allergen, Daily” are used. Icon will light up while using function. (For 929 Series). After selecting steam function, indicator gets light up at middle of knob. You can use programme in “Cotton, Synthetic, Mix” cycle. (For 979 series).

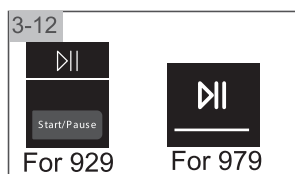

3.6 “Start/Pause” button

Press this button (Fig. 3-12) gently to start or interrupt the currently displayed programme.(For 929 Series).

Touch this button (Fig.3-12) gently to start or to interrupt the currently displayed programme. Durring running, LED shining and if interrupt, LED blinking. (For 979 Series).

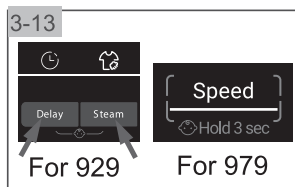

3.7 Child lock

Press button “Delay” and “Steam” (Fig.3-13) buttons for 3 Sec simultaneously for activating child lock function. For unlocking please touch those two buttons. The child lock indicator lights up when the child lock works. This is optional when machine is running. (For 929 Series)

Choosing a programme and then start, touch button “Speed” (Fig.3-13) for 3 sec simultaneously to block all activities of machine and display ☹️. For unlocking again touch button. (For 979 Series)



The display shows “c lol” (Fig. 3-14) if a button will be pressed that means the child lock is activated.



3.8-Function button “ *i-time*”

This function (Fig. 3-15) intensifies different washing time. Not all programmes can select this function.

See P11 for programs that can select this function. (For 979 Series)



3.9 “Stain removal” button

Touch this button (Fig. 3-16) to choose special features for stains. The symbols are explained in the following table.



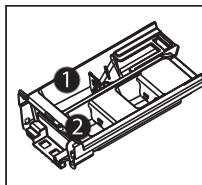

Detergent compartments :

① For Detergent

② For Softener or care product

For 929 Series

o Optional, /No

Programme	Max. load in kg	Temperature in °C				Fabric type	Preset spin speed in rpm	Function		
		Max. range	Preset	1	2			Steam	Additional Rinse	Delay
Cotton	7/7.5/8	90	30	o	o	Cotton	1000	o	o	o
Mix	3.5/4	60	30	o	o	Lightly soiled mixed- laundry of cotton and synthetic	1000	o	o	o
Synthetics	3.5/4	60	30	o	o	Synthetic or mixed fabric	1000	o	o	o
Babycare	3.5/4	90	40	o	o	Cotton/ synthetic	1000	o	o	o
Allergen	3.5/4	90	60	o	o	Cotton	1000	o	o	o
Daily	3.5/4	60	30	o	o	Cotton/ synthetic	1000	o	/	o
Jeans	1/1	40	30	o	o	Machine-washable fabric made of wool or with wool content	800	/	o	o
Delicate	2/2	30	30	o	o	Delicate laundry and silk	600	/	/	o
Refresh	/	/	/	/	/	Cotton/ synthetics	/	/	/	/
Quick 15	1/1	40	/	o	o	Cotton/ synthetics	1000	/	o	o
Spin	7/8	/	/	/	/	Non-fragile fabric	1000	/	/	/
Self Clean	/	/	/	/	/	/	/	/	/	/
Sportswear	2/2	40	20	o	o	Sport	800	/	/	o
Shirts	2/2	60	30	o	o	Shirts	1000	/	o	o
Duvet	2/2	/	/	o	o	Duvet	/	/	/	/

1) *: Water is not heated up.

Choose 90°C wash temperature only for special hygienic requirements.

2) Only one piece of adult or bulky clothing can be washed, and up to three pieces of children's clothing.

3) Reduce detergent amount because programme duration is short.

4) Do not use detergent instead of use a special machine cleaner.

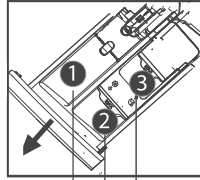

Detergent compartment for:

- ① Detergent
- ② Softener or care product
- ③ sanitizer³⁾

For 979 Series

• Yes, o Optional, /No

Programme	Max. load in kg	Temperature in °C ¹⁾ selectable range	Preset				Fabrics type	Preset spin speed in rpm	Function				
				1	2	3			i-time	Steam	Extra Rinse	Delay	Stain removal
Cotton+	8	* to 90	40	•	o	o	Cotton	1400	•	•	•	•	•
Easy care	4	* to 60	40	•	o	o	Synthetic or mixed fabric	1200	/	•	•	•	•
Allergen	4	* to 40	30	•	o	/	Disinfectant	800	•	/	•	•	/
Saree	2	* to 40	*	•	o	/	Delicate laundry and silk	800	•	/	•	•	/
Sportswear	2	* to 30	30	•	o	/	Sport	600	/	/	•	•	/
Refresh		* to 40	30	•	o	o	Cotton / Synthetic	1000	•	/	•	•	/
Spin	8	/	/	/	/	/	all fabrics	0	/	/	/	/	/
Baby Care	4	* to 90	40	•	o	o	Cotton / Synthetic	1000	•	•		•	/
Mix	4	* to 60	30	•	o	o	Lightly soiled mixed- laundry of cotton and synthetic	1000		•	•	•	•
Silent Wash	8	* to 40	*	•	o	o	Cotton / Synthetic	1000	•	/	•	•	/
Quick 15' ²⁾	1	* to 40	40	•	o	o	Cotton / Synthetic	1000	/	/	•	•	/
Delicate	2	* to 30	30	•	o	o	Delicate laundry and silk	1000	/	/	/	/	/
Self Clean	/	* to 20	20	•	o	o	/	1000	•	/	•	•	/
Remote	8	/	/	•	o	o	/	1400		/	/	/	/

4.1 BEE Programming:

For 929 & 979 Series:

Step 1: Select the "Cotton" programme.

Step2: Select the Temp range to 60°C

Step3: Press speed button for 5 sec.

Then start the programme for BEE programme.

5.1 Power supply

Connect the power cord to the power supply (220V~/50Hz; Fig. 5-1). Please refer also section "BEFORE USE". (For 929 & 979 Series).

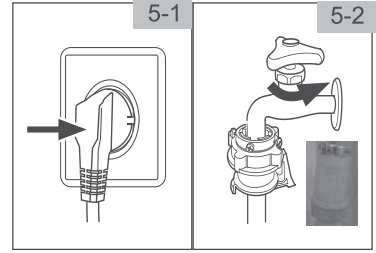

5.2 Water connection

- ▶ Before connecting the water inlet pipe, check the cleanliness and clarity of the water inlet.
- ▶ Turn on the tap (Fig.5-2).(For 929 & 979 Series).



Note: Tightness

Before use check for leakage in the joints between the tap and the inlet hose by turning on the tap.

5.3 Preparing laundry



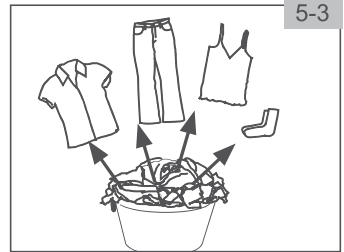

























- ▶ Sort out clothes according to fabric (cotton, synthetics, wool or etc.) and how dirty they are (Fig.5-3). Pay attention to the care labelling of washing labels.
- ▶ Separate white clothes from coloured ones. Wash coloured textiles first by hand to check if they fade then run.
- ▶ Empty pockets (keys, coins, etc.) and remove harder decorative objects (e.g. brooches).
- ▶ Garments without hems, delicates and finely woolen textile such as fine curtains are to be put into a wash bag to care (hand or dry cleaning would be better).
- ▶ Close zippers, fastener and hooks. Make sure that the buttons are sewen tightly.
- ▶ Place sensitive items like laundry without firm hems, delicate, underwear, and small items such as socks, belts etc in a wash bag.
- ▶ Unfold large pieces of fabric such as bed sheets, bedspreads etc.
- ▶ Turn jeans, printed, decorated, color intensive tiles inside out. (possibly wash separately)



CAUTION!

Non-textile, as well as small, loose or sharp-edged items may cause malfunctions and damage of clothes and appliance.

Care chart

Washing		
 Washable up to 90°C normal process	 Washable up to 60°C normal process	 Washable up to 60°C mild process
 Washable up to 40°C normal process	 Washable up to 40°C mild process	 Washable up to 40°C very mild process
 Washable up to 30°C normal process	 Washable up to 30°C mild process	 Washable up to 30°C very mild process
 Wash by hand max. 40°C	 Do not wash	
Bleaching		
 Any bleaching allowed	 Only oxygen/non-chlorine	 Do not bleach
Drying		
 Tumble drying possible normal temperature	 Tumble drying possible lower temperature	 Do not tumble dry
 Line drying	 Flat drying	
Ironing		
 Iron at a maximum temperature up to 200°C	 Iron at a medium temperature up to 150°C	 Iron at a low temperature up to 110°C without steam (Steam ironing may cause irreversibility damage)
 Do not iron		
Professional Textile Care		
 Dry cleaning in tetrachloroethene	 Dry cleaning in hydrocarbons	 Do not dry clean
 Professional wet clean	 Do not professional wet clean	

5.4 Loading the appliance

- ▶ Put the laundry in the drum piece by piece.
- ▶ Don't overload. Note the different maximum load according to programmes. Rule of thumb for maximum load : Check if you can put a hand upright on top of the load.
- ▶ Close the door carefully. Make sure that no pieces of laundry are pinched.

5.5 Selecting detergent

- ▶ Washing efficiency and performance is determined by used detergent quality.
- ▶ Use only machine wash approved detergent.
- ▶ If needed use specific detergents, e.g. synthetic and woolen fabric.
- ▶ Use detergent as per manufacturer recommendations.
- ▶ Do not use dry cleaning agents such as trichloroethylene and similar products.

► Choose the detergent (For 929 Series)

Programme	Kind of detergent				
	Universal	Colour	Delicate	Special	Softener
Cotton	√	√	-	-	√
Shirt	√	√	-	-	√
Baby Care	-	-	√	√	√
Duvet	-	-	√L	√	o
Delicate	-	-	√	√	√
Synthetics	-	√	-	-	√
Self Clean	-	-	-	√	-
Jeans	√L	√L	-	-	√
Mix	√L	√	-	-	√
Quick 15'	√L	√L	-	-	√
Sportswear	-	-	√	√	√
Refresh	-	-	-	-	-
Spin	-	-	-	-	-
Allergen	-	-	√	√	√
Daily	√	√	-	-	√

► Choose the detergent (For 979 Series)

Programme	Kind of detergent				
	Universal	Colour	Delicate	Special	Softener
Cotton+	√	√	-	-	√
Remove	√	√	-	-	√
Baby Care	-	-	√	√	√
Saree	-	-	√	√	√
Delicate	-	-	√	√	√
Easy Care	-	√	-	-	√
Self Clean	-	-	-	√	o
Silent Wash	√	√	-	-	√
Mix	√L	√	-	-	√
Quick 15'	-	√L	-	-	√
Sportswear	-	-	√	√	√
Refresh	√	√	-	-	√
Spin	-	-	-	-	-
Allergen	-	-	√	√	√

L = gel/liquid detergent P = powder detergent O = optional -- = no

√ = Recommended

If using liquid detergent, it is not recommended to activate the time delay.

We recommend to use :

- ▶ Laundry powder: 20°C to 90°C* (best use:40-60°C).
- ▶ Color detergent: 20°C to 60°C (best use:30-60°C).
- ▶ Wool/delicate detergent: 20°C to 30°C (best use:20-30°C).

* Choose 90°C wash temperature only for special hygienic requirements.



It is better to use less or free suds detergent powder.

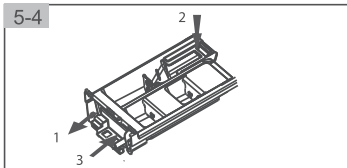

5.6 Adding detergent

1. Slide out the detergent drawer.
2. Put the required detergents into the corresponding compartments (Fig. 5-4).
3. Push back the drawer gently.



Note:

- ▶ Remove detergent residues before next wash cycle from the detergent drawer.
- ▶ Do not overuse detergent or softener.
- ▶ Please follow the instruction on the detergent package.
- ▶ Always fill the detergent just before the beginning of the wash cycle.
- ▶ Concentrated liquid detergent should be diluted before adding into compartment 2.
- ▶ The best use of liquid detergent is by using a dosing ball.
- ▶ Do not use liquid detergent, if “end time delay” is selected.
- ▶ Carefully choose the programme settings according to the care symbols on all laundry labels and according to the programme table.

5-5



For 929

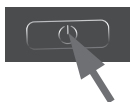

For 979

5.7 Switch on the appliance

Turn the knob to any position (except OFF) to start the machine. Turn the knob to the OFF position to shut down the machine (Fig. 5-5).(For 929 Series)

Touch the “Power” button to switch on the appliance (Fig.5-5). The LED of the “Start/Pause” button is flashing. (For 979 Series)

5-6

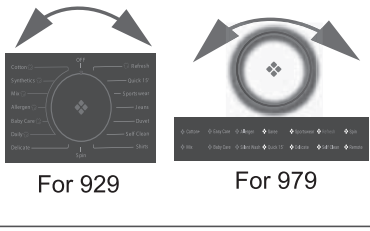

5.8 Select a programme

To get the best washing results, select a programme which fits the degree of soiling and sort of laundry type.

Turn the programme knob (Fig5-6) to select right programme. Pointer on knob will show selected programme.(For 929 Series).

Turn the programme knob (Fig5-6) to select right programme. LED will light up in front of selected programme.(For 979 Series).



Note: Odour removal

Before first use we recommended to run programme Self Clean with no load and small amount of detergent in detergent drawer compartment (2) or special machine cleaner to remove possibly corruptive residues.

5-7

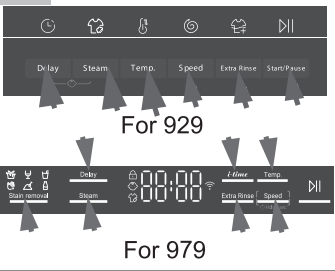

5.9 Add individual selections

Select required options and settings (Fig.5-7); refer to “CONTROL PANEL”(For 929 & 979 Series)

5-8



5.10 Start wash programme

Press “Start/Pause” button (Fig.5-8) to start. Appliance operates according to present settings. Changes are only possible by cancelling the programme.

5.11 Interrupt / cancel wash programme

To interrupt a running programme press gently “Start/Pause”. The LED in button is flashing.Press it again to resume operation.

To cancel a running programme and all its individual settings:

1. Press “Start/Pause” button to interrupt the running programme
2. Turn the knob to select a new programme and start it.



Note: Door lock

- ▶ For safety purpose the door is locked partially during the washing cycle. It is only possible to open the door at the end of programme or after the programme was cancelled correctly (see description above).
- ▶ In case of high water level, high water temperature and during spinning it is not possible to open the door; Lock is displayed.

5.12 After washing

1. At programme cycle end *End* is displayed.
2. The appliance switches off automatically.
3. Remove laundry as soon as possible to go easy on it and to prevent more wrinkling.
4. Turn off the water supply.
5. Unplug the power cord.
6. Open the door to prevent formation of moisture and odours. Let it open while not used. Minutes before starting the programme or at the end of programme. The display switches off.



Note: Standby mode / energy-saving mode

The switched on appliance will go into standby mode if it will not be activated within 2 minutes before starting the programme or at the end of programme. The display switches off and saves energy.

5.13 Activate or deactivate the buzzer

For 929 Series:

The acoustic signal can be deselected if necessary:

1. Switch on the appliance.
2. Select the “Self Clean” programme.
3. Press the “Extra rinse” button “Temp.” button and “Steam” button at the same time for about 3 seconds. “*BEEP OFF*” will be displayed and the buzzer will be deactivated. For activating the buzzer, press those three buttons at the same time again, then “*BEEP ON*” will be displayed.

For 979 Series:

The acoustic signal can be deselected if necessary:

1. Switch on the appliance.
2. Select the MIX programme.
3. Touch the “delay” button and “Temp.” button at the same time for about 3 seconds. “*BEEP OFF*” will be displayed and the buzzer will be deactivated.

For activating the buzzer touch these two buttons at the same time again. “*BEEP ON*” will be displayed.



Environmentally responsible use

- ▶ To achieve best use of energy, water, detergent and time you should use the recommended maximum load size.
- ▶ Do not overload (hand width clearance above laundry).
- ▶ For slightly solid laundry select the “Quick 15’ ” programme.
- ▶ Apply exact dosages of each washing agent.
- ▶ Choose the lowest adequate washing temperature - modern detergents are efficiently cleaning below 60 °C.
- ▶ Raise default settings only due to heavy staining.
- ▶ Select max. spinning speed if a domestic cloth is used.

7.1 Cleaning the detergent drawer

Take always care there are no detergent residues. Clean the drawer regularly (Fig. 7-1):

1. Pull out the drawer until it stops.
2. Press there lease button and remove the drawer.
3. Flush the drawer with water until it is clean and insert the drawer back in the appliance.

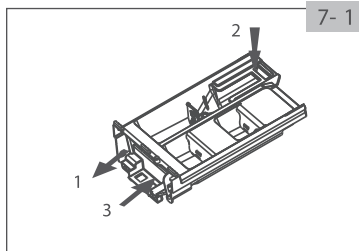

7.2 Cleaning the machine

- ☒ Unplug the machine during cleaning and maintenance.
- ☒ Use a soft cloth with soap liquid to clean the machine case (Fig. 7-2) and rubber components.
- ☒ Do not use organic chemicals or corrosive solvents.



7.3 Water inlet valve and inlet valve filter

To prevent blockage of water supply by solid substances like line clean regularly the inlet valve filter.

- ☒ Unplug the power cord and turn off the water supply.
- ☒ Unscrew the water inlet hose at the back of the appliance as well as on the tap (Fig.7-3.1).
- ☒ Remove the filters and flush them with water and a brush (Fig.7-3.2).
- ☒ Insert the filter and install the inlet hose.

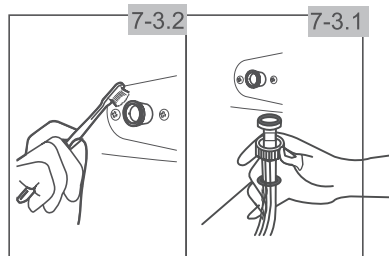

7.4 Cleaning the drum

- ☒ Remove accidentally washed metal parts such as pins, coins, etc. from the drum (Fig.7-4) because they cause rust, stains and damage.
- ☒ Use a non-chloride cleaner for removing rust stains. Observe the warning hints of the cleaning agent manufacturer.
- ☒ Do not use any hard objects or steel wool for cleaning.

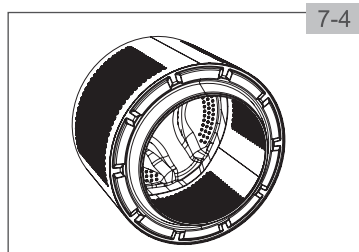

Note: Self Clean

For regular maintenance we recommend to run programme Self Clean with no load in order to remove possible corruptive residues quarterly. Add a small amount of detergent in washing agent compartment (2) - or use a special machine cleaner.

7-5.1

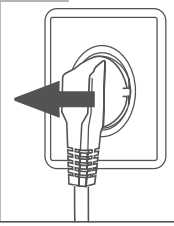

7-5.2

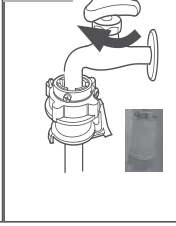

7.5 Long periods of disuse

If the appliance is left idle for a longer period:

1. Pull out the electrical plug (Fig. 7-5.1).
2. Turn off water supply (Fig. 7-5.2).
3. Open the door to prevent formation of moisture and odours. Let door open while not used.

Before next usage check carefully power cord, water inlet and drain hose. Make sure everything is properly installed and without leakage.



Note:

After long periods of disuse we recommend to run programme Self Clean with no load and small amount of detergent in washing agent compartment (2) or special machine cleaner to remove possibly corrosive residues.

7-6.1

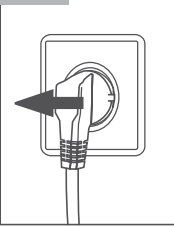

7-6.2

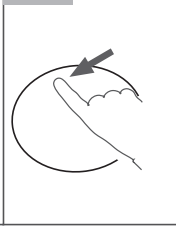

7.6 Pump filter

Clean the filter once a month and check the pump filter for instance if the appliance:

- ▶ Doesn't drain the water.
- ▶ Doesn't spin.
- ▶ Cause unusual noise while running.



WARNING!

Scalding Risk! Water in the pump filter can be very hot! Before any action please ensure water has cooled down.

7-6.3

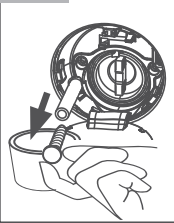

7-6.4

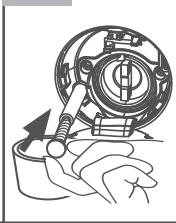

7-6.5



7-6.6

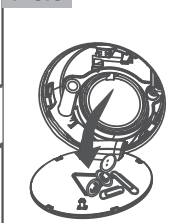

1. Turn off and unplug the machine (Fig. 7-6.1).
2. Open service flap. You can either use a coin or a screw driver (Fig. 7-6.2).
3. Provide a flat container to catch leaked water (Fig. 7-6.3). There could be bigger amounts.
4. Pull the drain hose out and hold its end above the container (Fig. 7-6.3).
5. Take the sealing plug out of the drain hose (Fig. 7-6.3).
6. After complete drainage close drain hose (Fig. 7-6.4) and push it back into the machine.
7. Unscrew and remove the pump filter (Fig. 7-6.5).
8. Remove contaminants and dirt (Fig. 7-6.6).

9. Clean carefully pump filter, e.g. using running water (Fig. 7-6.7).
10. Refix it thoroughly (Fig. 7-6.8).
11. Close service flap.

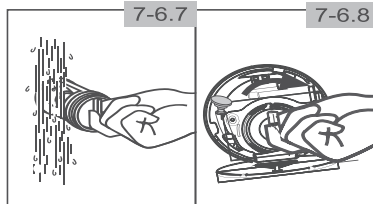

CAUTION!

- ▶ Pump filter sealing has to be clean and unhurt. If the lid is not full tightened, water can escape.
- ▶ The filter must be in place, or it may lead to leakage.

For 929 Series:

- Step 1: Scan below QR Code for app Download and install (available on manual also).
- Step 2: App Home Page
- Step 3: For User Login (Login in New Account).
Login ID- Customer Mobile No/ EMail ID.
Verification Code- Enter Verification code received on registered no.
- Step 4: Add Smart Product (WM)
- Step 5: Select Product
- Step 6: Select Model
- Step 7: Press "Speed +Extra Rinse" for 5 Seconds until the machine shows C5
- Step 8: Click on Blue Tick and Press Next
- Step 9: Mobile thru which App operated should be connected to same network as Machine.
- Step 10: Search same Wi-Fi network & input Wi-Fi password. Press Connect Network.
- Step 11: Process start of Connecting Machine
- Step 12: If not connected, needs to do "Connect Manually"
- Step 13: After Connected, for using can Press "Use Immediately"
- Step 14: Complete Loading 100%. Need to open Remote Authorization of Washing Machine.
- Step 15: Turn the Knob to Drum Clean Function, to start operating through App.
- Step 16: Start using App, various Online Programs available.
Programs will update as per new feature addition thru Wi-Fi application.

For 979 Series:

- Step 1: Scan below QR Code for app Download and install (available on manual also)
- Step 2: App Home Page
- Step 3: For User Login (For New Account Register).
- Step 4: Add Smart Product (WM)
- Step 5: Select Product
- Step 6: Select Model
- Step 7: Press "Power Button" 5 Seconds until the machine show C5
- Step 8: Click Blue Tick and Press Next
- Step 9: Mobile thru which App operated should be connected to same network as Machine.
- Step 10: Search same Wi-Fi network & input Wi-Fi password. Press Connect Network
- Step 11: Process start of Connecting Machine
- Step 12: If not connected, needs to do "Connect Manually"
- Step 13: After Connected, for using can Press "Use Immediately"

Step 14: Complete Loading 100%.

Step 15: Need to open Remote Authorization of Washing Machine.

Step 16: Turn the Knob to Remote Function, to start operating through App.

Step 17: Start using App, various Online Programs available.

Programs will update as per new feature addition through Wi-Fi application.

8

Troubleshooting

Many occurring problems could be solved by yourself without specific expertise. In case of a problem please check all shown possibilities and follow below instructions before you contact an after sales service. See CUSTOMER SERVICE.



WARNING!

- ☒ Before maintenance, deactivate the appliance and disconnect the mains plug from the mains socket.
- ☒ Electrical equipment should be serviced only by qualified electrical experts, because improper repairs can cause considerable consequential damages.
- ☒ A damaged power cable should only be replaced by the manufacturer, its service agent or similarly qualified persons in order to avoid a hazard.

8.1 Information codes

Following codes are displayed only for information referring to the washing cycle. No measures must be performed.

Code	Message
01:25	The remaining wash cycle time will be 1 hour and 25minutes.
06:30	The remaining wash cycle time including chosen end-time delay will 6 hours and 30 minutes.
0000	The washing cycle is finished. The appliance shuts off automatically.
0000	Function child lock is activated.
0000	Door is closed because of high water level, high water temperature or spinning cycle.
0000 00	The buzzer is deactivated.
0000 000	The buzzer is activated.

8.2 Troubleshooting with display code

Problem	Cause	Solution
000 0000	• Drainage error, water is not fully drained within 6 minutes.	• Clean pump filter. • Check drain hose installation.
00	• Lock error.	• Shut the door properly.
00	• Water level not reached to desired level. • Drain hose is self-syphoning.	• Make sure that tap is fully opened and water pressure is normal. • Check drain hose installation.
00	• Water protective level error.	• Contact the service agent
00	• Temperature sensor error.	• Contact the service agent
00	• Heating error.	• Contact the service agent

Problem	Cause	Solution
EE	<ul style="list-style-type: none"> Motor error. 	<ul style="list-style-type: none"> Contact the service agent
EEE EEE or EEE	<ul style="list-style-type: none"> Abnormal communication error. 	<ul style="list-style-type: none"> Contact the service agent
EEE	<ul style="list-style-type: none"> Unbalanced load error. 	<ul style="list-style-type: none"> Check and balance laundry load in the drum. Reduce the load.
EE	<ul style="list-style-type: none"> Water level sensor error. 	<ul style="list-style-type: none"> Contact the service agent

8.3 Troubleshooting without display code

Problem	Cause	Solution
Washing machine fails to operate.	<ul style="list-style-type: none"> Programme is not yet started. Door is not properly closed. Machine has not been switched on. Power failure. Child lock is activated. 	<ul style="list-style-type: none"> Check programme and start it. Close the door properly. Switch the machine on. Check power supply. Deactivate child lock.
Washing machine will not be filled with water.	<ul style="list-style-type: none"> No water. Inlet hose is kinked. Inlet hose filter is blocked. Water pressure is less than 0.03 MPa. Door is not properly closed. Water supply failure. 	<ul style="list-style-type: none"> Check water tap. Check inlet hose. Unblock inlet hose filter. Check water pressure. Close the door properly. Ensure the water supply.
Machine is draining while being filled.	<ul style="list-style-type: none"> Height of drain hose is below 80 cm. Drain hose end could reach into water. 	<ul style="list-style-type: none"> Make sure that drain hose is properly installed. Make sure the drain hose is not in water.
Drainage failure.	<ul style="list-style-type: none"> Drain hose is blocked. Pump filter is blocked. Drain hose end is higher than 100 cm above floor level. 	<ul style="list-style-type: none"> Unblock drain hose. Clean pump filter. Make sure the drain hose is properly installed.
Strong vibration while spinning.	<ul style="list-style-type: none"> Not all transportation bolts have been removed. Appliance has no solid position. Machine load is not correct. 	<ul style="list-style-type: none"> Remove all transportation bolts. Ensure solid ground and a levelled position. Check load weight and balance.
Operation stops before completing wash cycle.	<ul style="list-style-type: none"> Water or electric failure. 	<ul style="list-style-type: none"> Check power and water supply.
Operation stops for a period of time.	<ul style="list-style-type: none"> Appliance displays error code. Problem due to load pattern. Programme performs soaking cycle. 	<ul style="list-style-type: none"> Consider display codes. Reduce or adjust load. Cancel programme and restart.
Excessive foam floats drum and/or detergent drawer.	<ul style="list-style-type: none"> Detergent is not appropriate. Excessive use of detergent. 	<ul style="list-style-type: none"> Check detergent recommendations. Reduce amount of detergent.
Problem	Cause	Solution
Automatic adjustment of washing time.	<ul style="list-style-type: none"> Washing programme duration will be adjusted. 	<ul style="list-style-type: none"> This is normal and doesn't affect functionality.

Spinning fails.	<ul style="list-style-type: none"> • Unbalance of laundry. 	<ul style="list-style-type: none"> • Check machine load and laundry and run a spinning programme again.
Unsatisfactory washing result.	<ul style="list-style-type: none"> • Degree of pollution does not agree with selected programme. • Detergent quantity was not sufficient. • Maximum load has been exceeded. • Laundry was unevenly distributed in the drum. 	<ul style="list-style-type: none"> • Select an other programme. • Choose the detergent according to the degree of pollution and according to manufacturer specifications. • Reduce loading. • Loose the laundry.
Washing powder residues are on the laundry.	<ul style="list-style-type: none"> • Insoluble particles of detergent can remain as white spots on the laundry. 	<ul style="list-style-type: none"> • Perform extra rinse. • Try to brush the points from the dry laundry. • Choose an other detergent.
Laundry has grey patches.	<ul style="list-style-type: none"> • Caused by fats such as oils, creams or ointments. 	<ul style="list-style-type: none"> • Pretreat the laundry with a special cleaner.

i Note: Foam formation

If too much foam is inspected during spin cycle, motor stops and drain pump will be activated for 90 seconds. If that elimination of foam fails up to 3 times, programme ends without spinning.

Should the error messages reappear even after the taken measures, switch off the appliance, disconnect the power supply and contact the customer service.

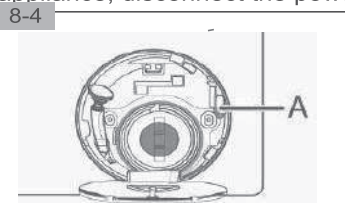

8.4 In case of power failure

The current programme and its setting will be saved. When power supply is restored operation will be resumed.

In case of power failure during programme run door opening is mechanically blocked. If the laundry is to be removed, the water level must not be visible in the glass door. -Danger of scalding!

- ▶ Lower the water level according to step 1 to 6 of chapter CARE AND CLEANING (PUMP FILTER).
- ▶ Pull lever (A) beneath service flap (Fig.8-4) until door is unlocked by a gentle click.
- ▶ Fix all parts and close the service flap.

9 Technical Data

9.1 Additional technical data

Model Name	HW70-IM12929 Series ; HW80-IM14979U1 Series HW75-IM12929 Series HW80-IM12929 Series
Dimension Height	850mm
Width	595mm
Depth	468mm
Power supply	220V~/50Hz
Current	10 A
Max. power	1800W
Water Pressure	0.03MPa≤P ≤1MPa
Max. spin speed	1200 rpm / 1400 rpm

What is E-Waste or Electronic Waste?

Electronic waste @ e-waste is a term which refers to unusable, discarded and old, electric & electronic appliances such as refrigerators, LED/LCD/CTV, microwave oven, washing machines, home air conditioner, etc. As per E-waste (Management and Handling) Rules, 2016 e-waste 'e-waste' means electrical and electronic equipment, whole or in part discarded as waste by the consumer or bulk consumer as well as rejects from manufacturing, refurbishment and repair processes has been categorized into three main categories, i.e., Consumer Electronics/Home appliances and IT & Telecom. Refrigerators, washing machines, home air conditioner LED/LCD, etc. represents Consumer Electronics/home appliances. On the other hand computers, desktop, laptop mobile phones, etc. and its component represents Telecom & IT.

E-waste broadly covers waste from all electronic and electrical appliances and contains different hazardous materials which are harmful to human health and the environment if not disposed of carefully. While some naturally occurring substances are harmless in nature, their use in the manufacture of electronic equipment often results in compounds which are hazardous for example chromium becomes chromium VI. Thus Ministry of Environment, Forest & Climate Change, Govt. of India had listed issued directions for the reduction in the use of hazardous substances in the manufacture of electrical and electronic equipment and their components or consumables or parts or spares. The Ministry of Environment, Forest & Climate Change, Govt. of India in furtherance of its effort to reduce the hazard occurring from rapid growth in the Consumer durable and IT-Telecom market had made rules called as E-Waste (Management and Handling) Rules, 2016 under Environment Protection Act.

HAZARDS OF IMPROPER HANDLING AND/OR IMPROPER RECYCLING OF ELECTRONIC WASTE

Electronic equipment contains many hazardous metallic contaminants such as lead, cadmium, and beryllium and brominated flame-retardants. An improper handling and/or improper recycling of the Electronic Waste results in these hazardous metals/substances getting released into our eco and biological system, thereby leading to various health hazards. The Hazardous contents in the electronic equipment include:

Health:- The informal method of recycling extended health hazards. For example, primary and secondary exposure to toxic metals, such as lead, results generally from open-air burning used to retrieve valuable components such as gold. Incineration from burning e-waste creates fine particulate matter, which is linked to pulmonary and cardiovascular disease.

Environment:- The informal method of recycling extended environment hazards too. For example when different e-waste is burnt to extract metals from it, toxic chemicals are released into the air, damaging the atmosphere.

- Lead
- Brominated Flame Retardants
- Chromium
- Mercury
- Beryllium
- Cadmium
- Barium
- Carbon Black
- Phosphor

E WASTE TOXIC COMPONENT & THEIR DAMAGE TO HUMAN HEALTH

Toxic Materials	Birth Defects	Brain Damage	Heart, Liver, Lung & Spleen Damage	Kidney Damage	Nervous/ Reproductive System Damage	Skeletal System Damage
Barium		X	X			
Cadmium			X			
Lead	X			X	X	X
Lithium	X	X		X	X	
Mercury	X	X	X	X	X	
Nickel	X	X	X	X		
Palladium	X		X	X		
Rhodium	X		X	X	X	
Silver		X	X			

Without safe recycling, most of these toxic components will end in land fill-poisoning soil and water.

The Dos of Electronic Waste Recycling:

1. Give the discarded Electronic Equipments only at the authorized collection centres so that the same can be properly recycled
2. Drop the discarded Electronic Equipments only in the bins meant for the Electronic Waste
3. Consult the authorized service centre as to whether the Electronic Equipment can be repaired or not, before discarding the same
4. Tell your neighbours and other persons about the hazards of improper disposal or handling or improper recycling of the Electronic Waste
5. If the unwanted Electronic Equipment still work or can be repaired then consider donating them

The Don'ts of Electronic Waste Recycling:

1. Don't dump the discarded Electronic Equipment in open or in any Land Fill Site as the same will result in contaminating the Soil and the groundwater
2. Don't dispose of the discarded Electronic Equipment in household bins or Municipal Bins
3. Don't sell or give your discarded Electronic Equipment to any Trash Dealer or Kabadiwala
4. Recycling Electronic equipment helps to save natural finite resources and also reduces the environmental and health risks associated with improper handling/disposing of the Electronic Waste
5. To minimize our impact on the earth and to protect the environment for future generations return your discarded Electronic Equipment here for safe recycling:

Why proper handling and management of e-waste is required?

According to MoEF, the electrical and electronic equipment (EEE) have valuable materials and hazardous/toxic substances in their components. The electronic products and electrical equipment after their useful life may not cause any harm if it is stored safely in households/stores. However, if the E-waste is opened-up and attempts are made for the retrieval of useful components or material in an unscientific manner or if the material is disposed of in open, then it may cause health risks and damage to the environment. E-waste can be considered as a resource that contains useful material of economic benefit for recovery of plastics, iron, glass, aluminum, copper and precious metals such as silver, gold, platinum, and palladium and lead, cadmium, mercury, etc. However, at the same time presence of heavy metals (As, Cd, Hg, Pb, etc.) and other toxic substances such as polychlorinated biphenyls (PCBs), etched chemicals, etc. may pose risk to health and environment during handling and recovery operations. E-waste is a product of increasing proportions especially when crude methods are adopted for the recovery of useful components from E-waste. Thus, there is a need to encourage the recycling of all useful and valuable material from e-waste so as to conserve the ever depleting natural resources. The electronic component is increasingly made from recycled materials, for example for making new LCDs, more than 50% of indium is sourced by recycling used LCDs. The E-waste thus presents a scenario of urban mining for recovery of ferrous/non-ferrous/ rare earth metal and precious metal in addition to plastics and glass. However, the presence of hazardous and toxic substances in the component of e-waste necessitates environmentally sound management of e-waste including collection and recycling/treatment in an environmentally sound manner.

Management and Effect on sustainable future:-

Sustainable development as defined by Brundtland Commission is "development that meets the needs of the present without compromising the ability of future generations to meet their own needs. The e-waste since a long time had been seen as an easy and cheapest source of metals. However, due to the lack of proper consideration for such a source of metals as well as proper methods of recycling in India, we sent our e-waste to the improper channel and thereby participated in degrading the environment. Moreover, through this improper method of extraction of metals we till date had wasted at least forty percent of the precious metals and simultaneously caused damage to our environment. If we opt the proper way to extract metals through proper channels of recycling then we can achieve Ninety percent of the extraction rate of our metals as well as a better way to save our environment. However, if today while selling off our material to the improper channel we will not think about our sustainable future then it is for sure that the coming generations will be facing crisis of the metals.

Customer/end-user responsibility

1. Consumers shall ensure that their end of life product/e-waste is channelized through collection center or dealer of the authorized producer or dismantler or recycler or through the designated take-back service provider of the producer to authorized dismantler or recycler;
2. Consumers shall ensure that such end-of-life electrical and electronic equipment are not admixed with e-waste containing radioactive material;

Bulk Consumer Responsibility:-

1. Bulk consumers of electrical and electronic equipment shall ensure that e-waste generated by them is channelized through collection center or dealer of authorized producer or dismantler or recycler or through the designated take-back service provider of the producer to authorized dismantler or recycler;
2. Bulk consumers of electrical and electronic equipment shall ensure that such end-of-life electrical and electronic equipment are not admixed with e-waste containing radioactive material as covered under the provisions of the Atomic Energy Act, 1962 (33 of 1962) and rules made thereunder;
3. Bulk consumers of electrical and electronic equipment listed in Schedule I shall maintain records of e-waste generated by them in Form-2 and make such records available for scrutiny by the concerned State Pollution Control Board;
4. Bulk consumers of electrical and electronic equipment listed in Schedule I shall file annual returns in Form-3, to the concerned State Pollution Control Board on or before the 30th day of June following the financial year to which that return relates;
5. In case of the bulk consumer with multiple offices in a State, one annual return combining information from all the offices shall be filed to the concerned State Pollution Control Board on or before the 30th day of June following the financial year to which that return relates.

Haier's Responsibility

Haier India being a responsible and trustworthy brand is taking all the necessary and expected steps for the betterment of the environment as well as living beings. Haier had joined hands with a number of recyclers to ensure environment-friendly recycling of the electronic items, such as refrigerators, washing machines, air conditioners, etc. that are either achieved their end of life or are old, unusable, etc. Apart from above, Haier had taken the following steps for proper recycling of e-waste of its customers:-

1. Collection and Channelization of e-waste:- Haier had setup toll free Number where the customers can call and registered their products for recycling. As soon as e-waste pick up is registered by the customer a representative will come to collect the product.
2. Dismantling & Recycling of e-waste:- Haier has appointed a number of recyclers who are the leading name in the recycling industry to responsibly and in an environment-friendly manner recycle the e-waste generated in India.
3. Awareness for e-waste:- Haier is actively sharing Infographics & engagement posts on its social platforms to create more awareness about e-waste and its hazards. In addition Haier is also conducting awareness programs in Schools, RWA's, Office Clusters etc to create awareness.

Collection Centre maintained by M/s WEEE- PRO Resource Recovery Solutions Private Limited (as on date)

STATE	ADDRESS	CONTACT PERSON	CONTACT NUMBER
Andhra Pradesh	Shop No.5, New Gajuwaka, Opp. High School Road, Andhra Pradesh-530026.	Mr. Juggli	9553088577
Assam	RN-34, Kundli Nagar Basistha Charali Near Parbat Apartment/Guwahati-781029	Mr. Sishram	9864046000
Chhattisgarh	Mig No.7, Ring Road No.2 Kabir Nagar Rajpur Chhattisgarh	Mr. Bijender Singh	9303906097
Gujarat	Shop No D-4 Panch Tenament, Bahad Momy Hotel, Isapur Gujarat-382442	Mr. Sandeep	9375688009
Haryana	J-171, New Patan Vihar Phase-1, Gurugram, Haryana 122017	Mr. Rajesh	9711563229
Jammu & Kashmir	S-1300 Chook Bari Brahminia Jammu - 181133, Jammu & Kashmir, Jammu-181133	Mr. Dharampal	9622565431
Jharkhand	K-36, Guna Naran Nagar Near Head Office Sachx Jharkhand Jharkhand - 833001	Mr. Niraj	9304002777
Karnataka	No.43, 1st floor 2nd Main D, U.T.T.L, Vishwapur Kamatiga -560022	Mr. Ratan Lal	9886250346
Kerala	Door No- 84D SPW Road, Windavan Ln, Choomkani, Kochi, Kerala-682108 CochinKochi, Kerala- 683106	Mr. Manish	9037991199
Madhya Pradesh	284, AS-3 Scheme No-78, Vidy Nagar MP	Mr. Yogesh	9302734152
Maharashtra	Plot No. 92, Gal Nari - 01 Sector 19C Vashi Navi Mumbai-400705	Balwan Singh	9372166150 9371644000
	Shop-3, Kallidore Complex, Anwarul Road, West Ghumna Maharashtra-440023	Balwan Singh	9860814787
	Plot No 28, Sector 5, Shiksha Colony Near Spine City, Mohali, Panchkula Maharashtra 412105	Balwan Singh	9370939911
New Delhi	Plot No. 619, Block A, Near Tata Talo Service Station, Rangpuri, Mahalaxa Delhi- 110037	Rajkumar Poonia	9810053907
Odisha	164 Floor Delta house Rajendra Nagar Madhupatna Cuttack, Orissa	Mr. Nihar Mahapatra	9337902236
Punjab	Shop No -15 & 16, Pathar Road, Opp - Tennis Academy, Zirakpur, Punjab-146003	Mr. Sanjeev	9316166155
Rajasthan	Plot No.81, 200 B, By Pass, Near Ajmer Road, Heerapura, Rajasthan - 302021	Mr. Yogesh Saharan	9309413301
Tamil Nadu	327 Sankh Corridor Phase II, Sreenivasapuram, Ponnambalam, Near Bales Water Plant Tamil Nadu 605056	Mr. Firoz Khan	9363166155 9362005006
Telangana	Shop No-4, Block-3/4th Shutter at 179, MPFS Estates Near Old Check Post, Secunderabad, Telangana - 500011	Mr. Ajay	9395166155 9395166156
Uttar Pradesh	S-317, Transport Nagar, Near ICTO Office Lucknow, UP-226212	Anuj Poonia	9335166155 9395166156
	Ch-122, Sector 70 Noida, UP-201301	Anuj Poonia	9999166155
West Bengal	156A/73, Northern Park, B.T. Road D/4, CPWB - 700104	Mr. Vinod Kumar	9331522536
West Bengal	R K Enterprise, Block Singhin, West Bengal 848209	Mr. Nawad	9027922929



Contact for further information:
Haier Appliances (India) Pvt. Ltd.
Building Number 1, Okhla Industrial Estate, Phase II, Opposite Modi Mill, New Delhi-110020.

Toll-Free Hotline Number
1800-102-9999
1800-419-9999

Query Between
9.00 AM to 9.00 PM
(Monday to Saturday)
Email- customer-care@haierindia.com

OUR PRO Partners (E-waste Partner) (as on date)

1. M/s WEEE- PRO RESOURCE RECOVERY SOLUTIONS PRIVATE LIMITED
Address: Flat-702, Tower-8, Unitech Horizon, Plot No.-6, Sector Pt-2, Greater Noida, Noida, Gautam Buddha Nagar, Uttar Pradesh, India, 201310
Contact Details : Mr Bhagwati Prasad Suman ; 9858445960 ; info@weee-pro.org; 1800-572-2961

2. PEGASUS SUSTAINABILITY PRIVATE LIMITED
Address: F-6, 1ST FLOOR, 4648/1, 21, ANSARI ROAD, DARYAGANJ, New Delhi, Delhi, 110002
Contact: Mr. Subratoo Mukherjee ; 9811707777; http://www.pegasusnetwork.in 1800-420-3177

3. Mis Green Planet
Address: 170, 105, Vasundhara, Gaziabad 201012
Contact Details : Mr. Anish Duggal; 9212503521; http://greenplanetpro.in/ 1800 8430 027

HAIER WARRANTY

HAIER APPLIANCES (INDIA) PVT. LTD. (hereinafter referred to as “the Company”) hereby offers the following warranty to the original domestic purchaser commencing from the date of the purchase. The Company, at its sole discretion, will free of charge repair or replace any defective part or parts which prove to be defective in workmanship and/or materials and not due to abnormal or improper usage.

CONDITIONS OF WARRANTY

- 1) This warranty will automatically terminate on the expiry of the warranty period from the date of delivery.
- 2) The Company is not liable for any delay in servicing due to reasons beyond the control of the Company or any of its authorised service centres.
- 3) Parts replaced or repaired under this warranty are warranted throughout the remaining of the original warranty period.
- 4) It is entirely left to the Company’s discretion to repair/replace parts at the site of installation or at the authorised service centre of the Company.
- 5) This warranty shall be strictly limited to the repairs or replacement of defective parts specified in the warranty. This warranty shall not cover any consequential or resulting liability.
- 6) This warranty shall not, in any case, extend towards payment of any monetary consideration whatsoever or replacement or return of the product.
- 7) The Company may repair/supply parts free of cost during the warranty period. This warranty does not cover any Excise duty, Central or Sales tax, Octroi and other local taxes or levies on the components/parts.
- 8) The parts shall be replaced by functionally operating equivalent material only and not with brand new ones and are likely to be different from the one originally fitted. The parts thus removed shall be taken back by the Company.
- 9) The Company reserves the right to retain any part or component replaced at its sole discretion during the warranty period.
- 10) In no event the Company or its authorised service centre be liable for any consequential damages or resulting liability, damage or loss arising directly or indirectly out of any defect in the product.
- 11) This warranty is not valid in case of the following events:
 - a) If the Product has been Installed/Serviced/Repaired/Opened or Tampered by any unauthorised personnel.
 - b) If defects arise/caused by accidents, alteration, misuse, neglect, substitution of original components with spurious/non-genuine components, attacked by household pest / rodents, fire, flood, earthquake, lightning and/or any other act of God/natural calamities.
 - c) The product is shifted outside India.
- 12) (a) For any service under this warranty beyond city/town/municipal limits from the Company/authorised service centre, a fixed charge of Rs. 50 will be collected from the customer in addition to the actual to and fro charges by the shortest route
(b) Service charges applicable after expiry of comprehensive warranty.
- 13) Any change of location or change in the ownership during the warranty period must be intimated in writing to the Company.
- 14) The Company’s employees or its authorised representatives have no authority to vary the terms of this warranty.
- 15) This warranty is effected in New Delhi and claims, if any, shall be made only before the courts having jurisdiction in New Delhi and no claim shall be made against the Company outside New Delhi notwithstanding that the Appliance may have been sold or delivered elsewhere.

WARRANTY		
Product	Period	Parts Not Covered
IM Series Models	Comprehensive-60 Months Motor -144 Months	Magic Filter, Drain Pipe, Top Lid, Inlet Pipe, Drain Pipe, Plastic Parts



HAIER APPLIANCES (INDIA) P. LTD., Building No -1, Okhla Industrial Estate, Phase-III, New Delhi-110020
Tel. : 011-39496000, 30674000, fax : 011-30674088, Website : www.haier.com/in



QR Code to directly chat with customer care executive.
(Customer Care WhatsApp No.: +91 8553049999)

Haier

Haier Appliances India Pvt. Limited

Building No. – 1, Okhla Industrial Estate,

Phase – 3, New Delhi - 110020

<https://www.haier.com/in/>

Haier Careline: 1800-419-9999, 1800-102-9999

Tel.: 011-39496000, 30674000.

Fax: 011-30674088,

Email: info@haierindia.com

Website: www.haier.com/in