

acer

SMART TELEVISIONS

USER MANUAL

This page is intentionally
left blank.

ATTENTION!

This product is qualified for the BEE Star rating in the “Home Mode”. The Objectives of Star Labeling Program are designed to promote energy efficient products and practices.

When the television is initially set up, it is designed to meet the BEE Star Labeling requirements while maintaining optimum picture quality.

- Changes to certain functionalities of this television (TV Guide, Picture/Sound etc) may change the power consumption.
- Depending upon such changed settings, the power consumption may vary, which possibly could exceed the stated energy consumption.







Note:

1. Figures and pictures in this manual are only for reference.
2. Design and specifications are subject to change without notice.
3. In a dry environment due to static electricity, the product may restart and return to the main OSD interface, USB player interface or the previous source mode. It is normal and please continue to operate the TV as you will.
4. Occasionally, a few non-active pixels may appear on the screen as a fixed point of blue, green, or red. Please note that this doesn't affect the performance of your product.
5. Displaying a still image for a prolonged period of time may cause image burnout. Avoid displaying a fixed image on the TV screen for a long period of time.

*Note: BEE Star Rating is only valid for HD & FHD

WARNING!

Important safety instructions

		Class II product: This symbol indicates that a safety connection to electrical earth (ground) is not required. If this symbol is not present on a product with a mains lead, the product MUST have a reliable connection to the protective earth (ground).
CAUTION: TO REDUCE THE RISK OF ELECTRIC SHOCK, DO NOT REMOVE THE BACK COVER. THERE ARE NO USER-SERVICEABLE PARTS INSIDE. REFER ALL SERVICING TO QUALIFIED PERSONNEL.		AC voltage: Rated voltage marked with this symbolic AC voltage.
 This symbol indicates that high voltage is present inside. It is dangerous to make any kind of contact with any internal part of this product.		DC voltage: Rated voltage marked with this symbolic DC voltage.
 This symbol indicates that this product has included important literature concerning operation and maintenance.		Caution: Consult instructions for use. This symbol instructs the user to consult the user manual for further safety related information.

The slots and openings in the cabinet and in the back or bottom are provided for necessary ventilation. To ensure reliable operation of this apparatus and to protect it from overheating, these slots and openings must never be blocked or covered.

- Do not place this apparatus in a confined space, such as a bookcase or built-in cabinet, unless proper ventilation is provided.
- Do not place this apparatus near or over a radiator or heat register, or where it is exposed to direct sunlight.
- Do not place vessels (vases etc.) containing water on this apparatus, as this can result in a fire or electric shock.
- Do not expose this apparatus to rain or place it near water (near a bathtub, washbowl, kitchen sink, or laundry tub, in a wet basement, or near a swimming pool, etc.). If this apparatus accidentally gets wet, unplug it, and contact an authorised dealer immediately.
- This apparatus uses batteries. In your community, there might be environmental regulations that require you to dispose of these batteries properly. Please contact your local authorities for disposal or recycling information.
- Do not overload wall outlets, extension cords, or adaptors beyond their capacity, since this can result in fire or electric shock.
- Power-supply cords should be placed so that they are not likely to be walked on or pinched by items placed upon or against them. Pay particular attention to cords at the plug end, at wall outlets, and at the point where they exit from the appliance.
- To protect this apparatus from a lightning storm, or when left unattended and unused for long periods of time, unplug it from the wall outlet and disconnect the antenna or cable system. This will prevent damage to the set due to lightning and power line surges.
- Before connecting the AC power cord to the DC adaptor outlet, make sure that the voltage designation of the DC adaptor corresponds to the local electrical supply.
- Never insert anything metallic into the open parts of this apparatus. This may cause a danger of electric shock.
- To avoid electric shock, never touch the inside of this apparatus. Only a qualified technician should open this apparatus.

- Be sure to plug in the power cord until it is firmly seated. When unplugging the power cord from a wall outlet, always pull on the power cord's plug. Never unplug it by pulling on the power cord. Do not touch the power cord with wet hands.
- If this apparatus does not operate normally - in particular, if there are any unusual sounds or smells coming from it - unplug it immediately and contact an authorised dealer or service centre.
- Be sure to pull the power plug out of the outlet if the TV is to remain unused or if you are going to leave the house for an extended period of time (especially when children, elderly, or disabled people will be left alone in the house).
- Accumulated dust can cause an electric shock, an electric leakage, or a fire by causing the power cord to generate sparks and heat or by causing the insulation to deteriorate.
- Be sure to contact an authorised service centre for information if you intend to install your TV in a location with heavy dust, high or low temperatures, high humidity, chemical substances, or where it will operate 24 hours a day, such as in an airport, a train station, etc. Failure to do so may lead to serious damage to your TV.
- Use only a properly grounded plug and wall outlet.
- An improper ground may cause electric shock or equipment damage. (Class I Equipment only.)
- To turn off this apparatus completely, disconnect it from the wall outlet. To ensure you can unplug this apparatus quickly, if necessary, make sure that the wall outlet and power plug are readily accessible.
- Store the accessories (batteries, etc.) in a location safely out of the reach of children.
- Do not drop or strike the product. If the product is damaged, disconnect the power cord and contact our service centre.

- To clean this apparatus, unplug the power cord from the wall outlet, and wipe the product with a soft, dry cloth. Do not use any chemicals such as wax, benzene, alcohol, thinners, insecticide, aerial fresheners, lubricants, or detergents. These chemicals can damage the appearance of the TV or erase the printing on the product.
- Do not expose this apparatus to dripping or splashing.
- Do not dispose of batteries in a fire.
- Do not short-circuit, disassemble, or overheat the batteries.
- There is a danger of an explosion if you replace the batteries used in the remote with the wrong type of battery. Replace only with the same or equivalent type.

WARNING:

This product contains a battery. Do not ingest the battery - Chemical Burn Hazard. If the battery is swallowed, it can cause severe internal burns in just 2 hours and can lead to death. Keep new and used batteries away from children. If the battery compartment does not close securely, stop using the product and keep it away from children.

If you think batteries might have been swallowed or placed inside any part of the body, seek immediate medical attention.

Note:

Figures and illustrations in this User Manual are provided for reference only and may differ from the actual product appearance. Product design and specifications may change without notice.

UNBOXING

Make sure the following items are included with your TV. If any items are missing, contact your dealer.

Note: The pictures are only for reference.

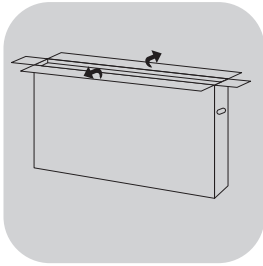

1. Open the package carefully

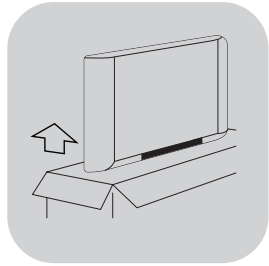

2. Take out the TV carefully



Warning: Screen can be damaged from direct pressure when handled incorrectly. We recommend lifting the TV at the edges, as shown.

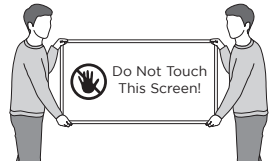

STANDARD ACCESSORIES

Note: The pictures are only for reference.



Batteries
AAA - 2N

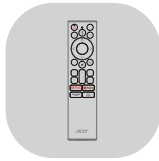

Remote
Control - 1N

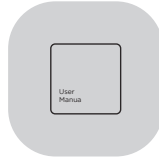

User
Manual - 1N



Warranty
Card - 1N



Power
Cable - 1N



Stand - 2N
Screw - 4N

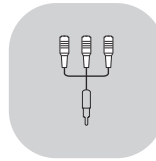

AV
Cable - 1N

INSTALLATION

Installing the TV to the wall

- Your TV can be mounted on a wall using a wall-mount bracket (which might not be supplied for some models) out of the box as packaged.
- If the table-top stand is attached to the TV, the TV may require detaching the table-top stand.
- Prepare the TV for the wall-mount bracket before making cable connections.
- For product protection and safety reasons, it is strongly recommended that the installation of your TV on the wall be performed by qualified professionals.
- Use an authorized wall mount bracket and contact the local dealer or the after-sales service team for the installation. Do not attempt to install by yourself. Otherwise, it is not covered by warranty.
- Carefully attach the wall mount bracket at the rear of the TV. Install the wall mount bracket on a solid wall perpendicular to the floor. If you are attaching the TV to other building materials, please contact qualified personnel to install the wall mount.
- Sufficient expertise is required in installing this TV, especially to determine the strength of the wall for withstanding the TV's weight.
- If you install the TV on a ceiling or slanted wall, it may fall and result in severe injury.
- The length of the screw for the wall-mount bracket differs depending on the wall-mount brackets thickness. Please use the screws paired with the wall-mount bracket.

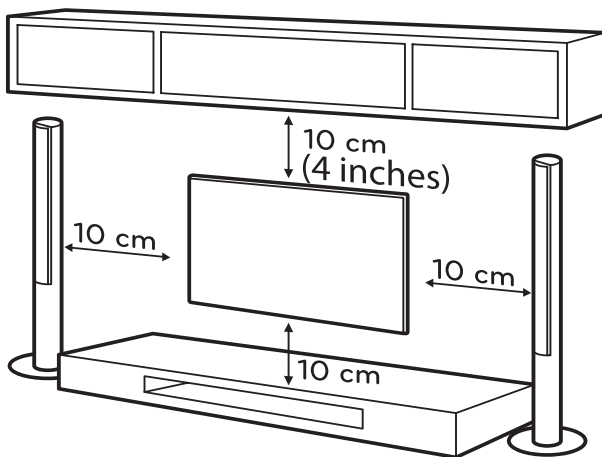

Installing the TV with table-top stand

- To avoid falling over, two or more persons are needed to handle a large TV.
- Avoid touching the screen so as not to cause damage to the screen.
- Take out the TV and carefully put it (screen downward) on a stable and flat surface with a smooth & soft cloth or cushion on it.
- Connect the TV and base by inserting and fastening matched screws into the holes.

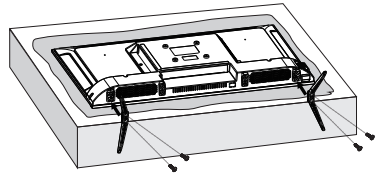
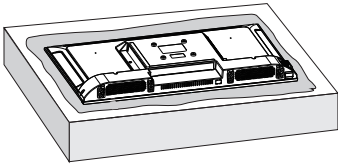

Providing proper ventilation for your TV

When you install your TV, maintain a distance of at least 10 cm between the TV and other objects (walls, cabinet sides, etc.) to ensure proper ventilation. Failing to maintain proper ventilation may result in a fire or a problem with the product caused by an increase in its internal temperature.

When you install your TV on a stand or a wall mount, we strongly recommend you use parts provided along with your device. Using parts provided by another manufacturer may void the warranty provided with the device.

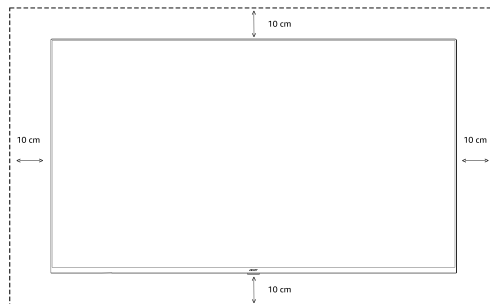

Note: The picture is only for reference.

WARNING:

- Never place a television set in an unstable location. The television set may fall, causing serious personal injury or death. Many injuries, particularly to children, can be avoided by taking simple precautions such as
 - Using cabinets or stands recommended by the manufacturer of the television set.
 - Only use furniture that can safely support the television set.
 - Ensuring the television set is not overhanging the edge of the supporting furniture.
 - Not placing the television set on tall furniture (for example, cupboards or book-cases) without anchoring both the furniture and the television set to a suitable support.
 - Not placing the television set on cloth or other materials that may be located between the television set and supporting furniture.
 - Educating children about the dangers of climbing on furniture to reach the television set or its controls.
 - If you are retaining and relocating the television set that you are replacing with this new set, you should apply the same precautions to the old set.

Usage restrictions:

Do not install/use the TV in the following places, environments or conditions; otherwise the TV may malfunction and cause a fire, electric shock, damage or personal injury.

Places

Outdoors (in direct sunlight), by the sea, in a ship or other vessel, inside a car, in a medical institution, at an unstable location, next to water, or in a place exposed to rain, moisture, or mildew. If the TV is placed in the dressing room of a public bath or spa, it may be damaged by the sulphide in the air.

Environment

Hot, damp or dusty places: places where insects may enter, places that may be exposed to mechanical shock, next to flammable objects (such as candles). The TV should not be exposed to dripping or splashing water, and do not place any items containing liquid such as flower vases on top of the TV. Do not place the TV in a damp or dusty place, or in a room with steam or fumes (near a stove or humidifier) to avoid fire, electric shock or deformation. Do not boil water, heat, cook, or use mosquito coils near the TV.

Conditions

Do not use the TV when your hands are wet, when the case is open, or with accessories that are not authorized by the manufacturer. In the case of a lightning storm, disconnect the TV from the AC power cord and outlet. Do not install the TV in an open-air location. Failure to follow these conditions may result in personal injury or damage, or cause damage to the TV.

Damage to Acer TV screen

Do not throw any object toward the TV; otherwise, the screen may be broken due to the impact and cause serious injury. In case of damage to the surface of the TV, do not touch the TV before the AC power cord has been unplugged; otherwise electric shock may occur.

Operating conditions

Operating temperature: 5°C to 45°C









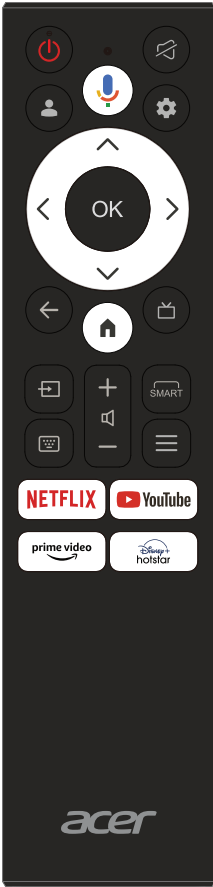



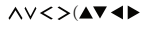

Humidity: 20% to 80%

Storage temperature: -15°C to 40°C

Relative humidity: <80%

THE REMOTE CONTROL



-  (On/Off button) Turns the TV on or off
-  To mute and un-mute the sound.
-  Switch profile.
-  Enter into Using TV System menu.
-  Start talking to Google Assistant of the TV
-  (up, down, left and right direction buttons) Highlights different items in the menu system.
- OK** Confirms your selection.
-  Exit the menu and return to the previous menu.
-  Goes to the smart TV homepage.
-  Open live TV EPG.
-  To enter source selection interface.
- SMART** To enter SMART function interface.
- Volume**  Increases or decreases the TV's volume.
-  To pop up the virtual remote control keyboard.
-  To access the options menu.
- NETFLIX** Goes to the NETFLIX homepage.
-  Goes to the YouTube homepage.
-  Goes to the prime video homepage.
-  Goes to the Hotstar homepage

THE REMOTE CONTROL - Proper Usage

Installing Batteries

Place two AAA size of batteries in the remote control's battery compartment, making sure to match the polarity markings inside the compartment

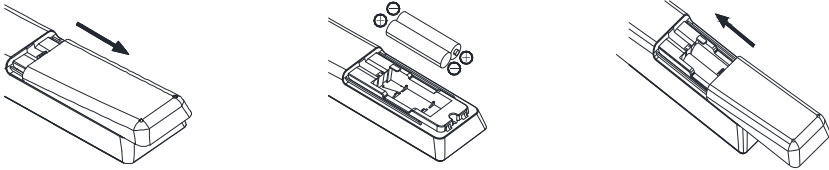

Notes on Using Batteries

Improper use of the batteries will cause leakage and/or explosion. So please do as the following methods and use them carefully.

- Always ensure that batteries are inserted with the polarity terminals in the correct direction as polarity markings are in the battery compartment.
- When the battery's voltage is insufficient, which affects the use range, you should replace it with new batteries. Replace batteries only with the same or equivalent type. It may result in an explosion if batteries are replaced incorrectly.
- Different types of batteries have different characteristics. Do not use different types of batteries (for example, Manganese and Alkaline batteries) together.
- Do not mix old and new batteries. Mixing old and new batteries will shorten battery life and/or cause chemical leakage.
- Chemicals which leak from batteries may cause skin irritation. If any chemical matter seeps out of the batteries, wipe it up immediately with a dry cloth.
- Remove the batteries whenever the remote control will not be used for a long time.
- Do not put the battery on fire, and charge or decompose the battery.
- Please dispose of batteries in compliance with relevant environmental protection regulations.

WARNING: The batteries (battery pack or batteries installed) shall not be exposed to excessive heat such as sunshine, fire or the like.

Intended use of the product

This is a consumer electronics device. It is used to receive TV via an antenna or cable TV network, and to playback multimedia files from the internet and USB storage devices. It may only be used for private purposes and not for industrial or commercial applications. It is not intended for medical, life-saving or life-preserving applications.

Only use connecting cables and external devices which are compatible with the product in terms of safety, electromagnetic compatibility and shielding.

Only use accessories recommended by the manufacturer. Do not use this device for purposes other than those indicated, and do not modify it in any way. Always comply with the regulations and laws of the country in which you are operating the device.





How to Pair Remote Control with the TV

This is a Bluetooth remote control, and before using it, please pair it with the TV firstly. The following steps are for your reference:

Step 1: Press  button to enter the home page.

Step 2: Press  button to enter the "RC pairing".



Step 3: Follow the "Settings tips page" Press  and  together.

Step 4: The screen will display "Pairing...", Pair finished the screen will display "Success!".

NOTE: If you wait more than 2 minutes and it can't pair, please repeat the above steps for pairing again.

If you want to unpair the Bluetooth remote, Follow as below steps:

Step 1: Press  button to enter the home page.

Step 2: Press   to choose , and then press **OK** to enter.

Step 3: Press  to select "Remotes & Accessories" and then to choose the Bluetooth remote name to enter next steps.

Step 4: Press unpair and then choose OK button.

Using Homepage

Note:This manual is for common use. Figures and illustrations in this User Manual are provided for reference only and may differ from actual product appearance. And for some models, certain options are not available.

You can select all the features from homepage.

Press **⌂** to display homepage.

Press **▲/▼/◀/▶** to select icons from the screen list.

Press **OK** to enter each option.

Press **←** or **⌂** to exit the APP.

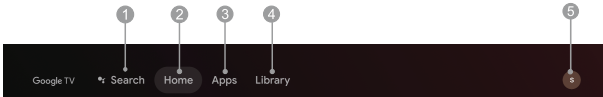

- 1. Search:** Hold the Assistant button down and talk Search movies shows, apps and more.
- 2. Home:** Select icons from the screen list.
- 3. Apps:** Show the list of favorite applications, or access the application center.
- 4. Library:** Your Library is empty, Find your purchases, rentals, and watchlisted content across TV mobile, and web here.
- 5. S:** You can select Settings, Inputs, Picture and view notifications.

Note:

- 1) The functions and contents of "Home Page" may vary by different countries or models.
- 2) Before using network functions in home page like network applications and so on, please connect the TV to the network firstly.
- 3) Icon copyrights are owned by the application providers.

Using System Settings

The Settings menu allows you to configure the TV with your preferences.

Note: Some of the functions might be unavailable in certain sources. And for some models, certain options are not available.

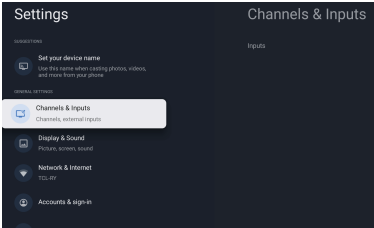

Each menu is outlined and detailed to help you get the most from your TV. To access the menu system:

1. Press **▲/▼** to select the desired item, then press **OK** to open the corresponding submenu.
2. In submenu, use **▲/▼** and **OK** buttons to make the adjustments, or use **▲/▼** to select an item, use **OK** to enter and operate according to the on-screen display or guide.
3. Press **←** to return to the previous menu.

Picture

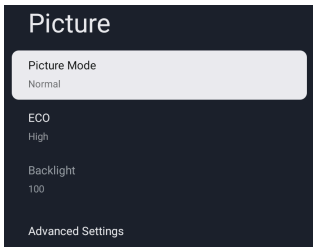

Picture Adjustment:

- Picture Mode: Optimize picture quality for general content. Use **▲/▼** to scroll through the Picture preset settings: Normal, Dynamic, Cinema, Sport, Game and Custom.
- ECO: You can select Off, Low and High.
- Backlight: Select the level of 0-100.
- Advanced Settings: Access advanced picture enhancing options.
- Color Temperature:** Adjusts the color saturation.
- Dynamic Contrast:** Adjusts the Dynamic Contrast of the picture.
- HDMI PC/ AV Mode:** Select Video, PC and Auto.
- Overscan:** Select ON or OFF.
- Noise Reduction:** Select Off, Low, Middle, High, Auto.
- Picture Reset:** To reset picture adjustment.
- ALLM:** ALLM On and Off.
Switch ALLM Mode to ON and Switch on Game Mode in Xbox. Connect Xbox to HDMI port. Set HDMI mode to 2.0 in TV for Gaming experience (HDMI 1.4 does not support ALLM)
- Motion Estimate and Motion Compensation(MEMC):** Refines moving images.
- Gamma:** Select 2.2 or 2.4.

Sound

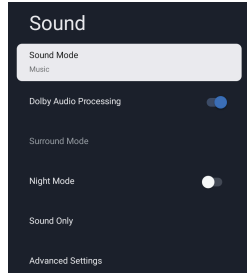

Sound: Adjust sound and speaker-related options.

- Sound Mode: Optimize sound quality for general content. Use **▲/▼** to scroll through the sound preset settings: Standard, Speech, Music, Stadium and User.
- Dolby Audio Processing: Select ON or OFF.
- Surround Mode: Reproduces life-like surround sound when playing 5.1-channel audio sources. Include On and Off.
- Night Mode: On and Off.
- Sound Only: Select Sound Only mode setting.
- Advanced Settings: Access Advanced sound enhancing options.

System

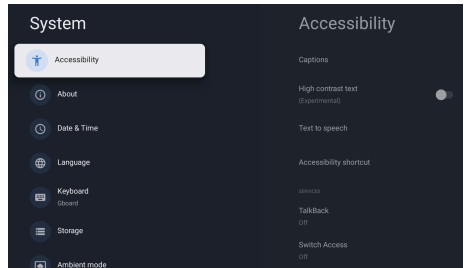

Each menu is outlined and detailed to help you get the most from your TV. To access the menu system:

1. Press **▲/▼** to select the desired item, then press **OK** to open the corresponding submenu.
2. In submenu, use **▲/▼** and **OK** buttons to make the adjustments, or use **▲/▼** to select an item, use **OK** to enter and operate according to the on-screen display or guide.
3. Press **←** to return to the previous menu.

BASIC OPERATIONS – Use Chromecast built-in

Your Acer TV comes with Chromecast built-in technology. Use your mobile device to stream your favourite shows, movies, music, sports, games, and more to the big screen.

To cast content from your hand-held device onto you TV, follow the following steps:



Connect your phone or tablet to the same WiFi network as your TV.



Open a Chromecast enabled app like YouTube. Cast content from 1000s of cast enabled apps.



Simply tap the Cast button from within the app to send your content from mobile to the big screen.

BASIC OPERATIONS – Google Meet

Follow the steps below:

1. Login your Google Account
2. Search Google Meet in the Direct Search option of Home Screen
3. Download and install Google Meet
4. Connect webcam* via USB port
5. Open Google Meet and login with your Google ID
6. Allow permission to access
7. Your Google Meet setup is finished. Enjoy video calling on your Acer television

***Note:** List of compatible webcams is below

1. Microsoft Life Cam HD-3000
2. Logitech HD Pro Webcam C920
3. Logitech HD Pro Webcam C920 Pro
4. Aoni A30

NOTE: Webcam is not a part of standard accessory

BASIC OPERATIONS – eARC

Follow the steps below:

1. Connect your external Soundbar using an HDMI cable
2. Connect your Acer television with the external Soundbar using HDMI 1 port
3. Go to Settings on Homepage
4. Select Display & Sound
5. Select Sound
6. Select Audio Output
7. Select eARC and turn it ON

***Note:** eARC is only available in 4K UHD models

TROUBLESHOOTING

Before calling a service technician, please check the following for a possible cause of the symptom and some solutions.

General Problem / Solution

Remote control does not work

Change the batteries.

Check if batteries are installed correctly. Check if the main power is connected.

Check if there are any items between the remote sensor and remote control.

Poor Signal

This is usually caused by interference from electronic equipment or radio interference sources.

Picture & Sound / Solution

No picture, no sound

Check the signal source.

Plug another electrical device into the outlet to check if it is working or turned on. Check if the power plug is in good contact with the outlet.

No sound, picture OK

If no sound is heard, unmute the sound or increase the volume. Open the sound menu and adjust 'Balance'.

Abnormal picture

For no colour or bad picture quality, you may:

1. Adjust the colour option in menu settings.
2. Keep the TV at a sufficient distance from other electronic products.
3. Try another channel.

Bad TV signal (Display mosaic or snowflakes)

1. Check the signal cable and adjust the antenna.
2. Fine-tune the channel.
3. Try another channel.

Multimedia Player / Solution

'This file is invalid' / 'Unsupported audio' appears, or audio is normal, but the video is abnormal, or video is normal, but the audio is abnormal. The media file may be damaged, check if the file can be played on the PC. Check if video and audio codec are supported.

Network / Solution

Network failure

Check if the router works well.

Make sure the TV has been connected to the router successfully.

Browser / Solution

Web page cannot be displayed completely

Some third-party extensions of the current web page may not be supported, so please close the current web page.

Browser is forced to be shut down

The current web page may include too many contents which causes there isn't sufficient memory and the browser is closed.

LICENSING INFORMATION



The Acer trademarks are licensed to Indkal Technologies Private Limited by Acer Incorporated, a Taiwan R.O.C. company.



Google, Android TV, Google Play, Chromecast built-in, YouTube, and other related marks and logos are trademarks of Google LLC.



The Adopted Trademarks HDMI, HDMI High-Definition Multimedia Interface, and the HDMI logo are trademarks or registered trademarks of HDMI Licensing Administrator, Inc. in the United States of America and other countries.



Dolby, Dolby Vision, Dolby Atmos, and the double-D symbol are registered trademarks of Dolby Laboratories Licensing Corporation. Manufactured under license from Dolby Laboratories. Confidential unpublished works.

E-WASTE MANAGEMENT

Environmental compliances:

As per the rules laid down by the Government for environmental concern & safety, your product has been made to comply and conform to the respective regulation as listed below. This product falls under the E-WASTE (MANAGEMENT) RULES, 2016 all amendments of Ministry of Environment, Forests & Climate Change.

RoHS declaration:

This product conforms with the requirements of Rule 16 of the E-WASTE (MANAGEMENT) RULES, 2016, all amendments. The content of hazardous substances with the exemption of the applications listed in the SCHEDULE II of the E-waste (Management) Rules, 2016 is as follows:

1. Lead (Pb): not over 0.1% by weight;
2. Mercury (Hg): not over 0.1% by weight;
3. Cadmium (Cd): not over 0.01% by weight;
4. Hexavalent Chromium: (Cr6+): not over 0.1% by weight;
5. Polybrominated Biphenyls (PBBs): not over 0.1% by weight;
6. Polybrominated Diphenyl Ethers (PBDEs): not over 0.1% by weight.

For more information under E-Waste (Management) Rules, 2016, for disposal of E-waste, please call our helpline no. **91-76696 10805** or visit **www.acertvin-dia.com/ewaste**



Do's and Don'ts for disposal of the product:

1) Do's:

- a. Always drop off your used electrical/electronic products, batteries, cables, adapters, and packaging materials after the end of their life at the nearest authorized collection point/centre.
- b. Separate the packaging material according to their respective waste disposal options and sorting for recycling.
- c. Always call Authorized E-waste Recyclers to Dispose off products that have reached end-of life.

2) Don'ts:

- a. Never dump E-waste in Garbage bins or Municipal solid waste streams.
- b. Do not dispose of your product as unsorted municipal waste.
- c. Do not throw or dispose of used, damaged or leaking batteries & products into household waste.

Happy to help you!

www.acertvindia.com

support@acertvindia.com

+91-76696 10805