

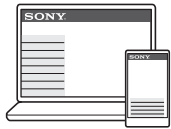

K-75XR71 / 75XR70 / 65XR71 / 65XR70 / 55XR71 / 55XR70

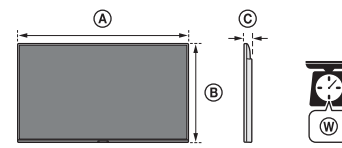

https://rd1.sony.net/help/tv/lga1/h_ga/



	(mm)*1			(kg)*1
	(A)	(B)	(C)	(W)
K-75XR71 / 75XR70	1668	960	57	38.3
K-65XR71 / 65XR70	1445	832	57	27.1
K-55XR71 / 55XR70	1225	709	56	19.9

*1 (Approx.)

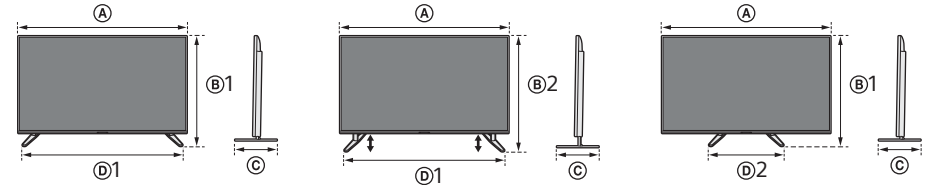

	(mm)*1						(kg)*1
	(A)	(B1)	(B2)	(C)	(D1)	(D2)	(W)
K-75XR71 / 75XR70	1668	984	1038	405	1442	518	40.1
K-65XR71 / 65XR70	1445	856	910	345	1217	480	28.3
K-55XR71 / 55XR70	1225	733	787	345	1083	436	21.1

*1 (Approx.)

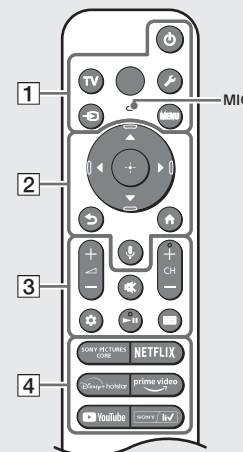
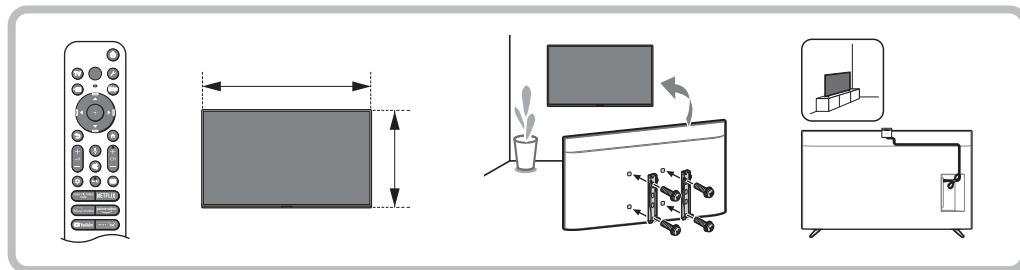
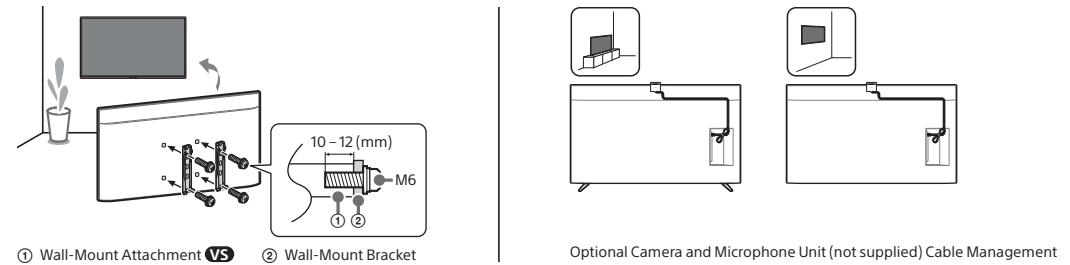

The remote control shape, layout, availability and function of remote control buttons may vary depending on your region/country/TV model/TV settings.

- 1 **(Power)**
TV: Display TV channel list or switch to input.
(Quick settings): Display Quick Settings.
(Input select): Display and select the input source, etc.
MENU (Control menu): Display the Control menu.
- 2 **▲/▼/◀/▶/⊕**: On screen menu navigation and selection.
(Back)
(Home)
(Google Assistant / Microphone): Use Google Assistant*1*2 or voice search*2.
- 3 **+ / - (Volume)**
(Mute)*3
CH + / - (Channel)

- (Dashboard)**: Display Dashboard.
- (Guide)**: Display the digital programme guide of TV or TV box*4.

- 4 **App buttons**
- *1 Only for limited region/country/model/ language.
- *2 Google Assistant or voice search requires an Internet connection.
- *3 Accessibility shortcut is available by pressing and holding **(Mute)**.
- *4 [TV box setup] setting is required.

Note

- Instructions about “Installing the TV to the Wall” are included within this TV’s instruction manual.
- Read the supplied safety documentation for additional safety information.

Location of the identification label

Labels for the TV Model No. and Power Supply rating are located on the rear of the TV.

Installing the TV to the Wall

Using the optional Wall-Mount Bracket (not supplied)

This TV’s instruction manual only provides the steps to prepare the TV for Wall-Mount installation before it is installed on the wall.

Your TV can be mounted to a wall using a suitable Wall-Mount Bracket (not supplied). If the Table-Top Stand is attached to the TV, the TV may require detaching the Table-Top Stand (models with Table-Top Stand only). Prepare the TV for the Wall-Mount Bracket before making cable connections.

For product protection and safety reasons, Sony strongly recommends that installation of your TV on the wall be performed by qualified professionals. Do not attempt to install it yourself.

- Follow the instruction guide provided with the Wall-Mount Bracket for your model. Sufficient expertise is required in installing this TV, especially to determine the strength of the wall for withstanding the TV’s weight.
- The screws for installing the Wall-Mount Bracket to the TV are not supplied.
- Be sure to store the unused screws and Table-Top Stand in a safe place until you are ready to attach the Table-Top Stand (models with Table-Top Stand only). Keep the screws away from small children.

Note

- Read the supplied safety documentation for additional safety information.

- 1 Remove the screws from the rear of the TV.

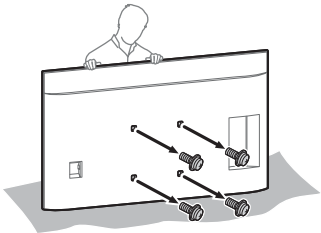

- 2 Attach the Wall-Mount Attachment (supplied with the TV) to the rear of the TV (to make it parallel with the wall).

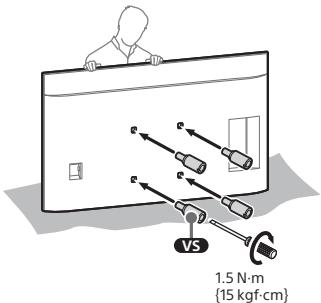

- 3 Attach the Wall-Mount Bracket (not supplied) using the screws (not supplied).

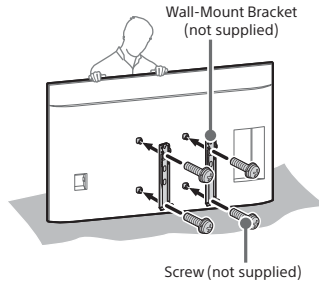

Note

- If using an electric screwdriver, set the torque at approximately 1.5 N·m {15 kgf·cm}.
- Be sure to fasten the Wall-Mount Attachment when attaching them to the TV. Use only a flat head screwdriver to install the Wall-Mount Attachment. Use of another tool might result in over torquing the Wall-Mount Attachment and damaging the TV.
- Be sure the TV is vertical before turning on. To avoid uneven picture uniformity do not power on the TV with the LCD panel facing down.

Troubleshooting

General troubleshooting for issues like: black screen, no sound, frozen picture, TV does not respond, or network is lost, do the following steps.

- 1 Restart your TV by pressing the power button on the remote control for about five seconds. The TV will restart. If the TV does not recover, try unplugging the AC power cord (mains lead) then press the power button on the TV and release it. Wait for two minutes, and plug in the AC power cord (mains lead). Or, press the power button on the TV for about 40 seconds until the TV turns off.
- 2 Refer to the Help menu shown below.
- 3 Connect your TV to the Internet and perform a software update. Sony recommends you to keep your TV software updated. Software updates provide new features and performance improvements.
- 4 Visit Sony support website (information provided at the end of the supplied safety documentation).

When you plug in the TV, the TV may not be able to turn on for a while even if you press the power button on the remote control or the TV.

It takes time to initialize the system. Wait for about one minute, then operate it again.

The remote control does not function.

- Replace the batteries.

The parental lock password has been forgotten.

- Enter 9999 for the PIN and enter the new PIN.

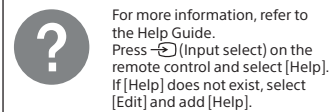

Specifications

System

Panel system
LCD (Liquid Crystal Display) Panel, LED Backlight
TV system
Analogue: B/G
Digital: DVB-T/DVB-T2
Satellite: DVB-S/DVB-S2
Colour system
PAL/SECAM
Channel coverage
Analogue: UHF/VHF/Cable
Digital: UHF/VHF
Satellite: Intermediate Frequency 950-2150 MHz
Sound output*1 (W)
10 + 10 + 10 + 10
Wireless technology
Protocol IEEE 802.11a/b/g/n/ac/ax
Bluetooth® Version 5.3

Input/Output jacks

Antenna (aerial) cable
75 ohm external terminal for RF input
Satellite antenna
Female F Type Connector, 75 ohm
LNB13 V/18 V & 22 kHz tone
HDMI IN 1/2/3/4 (HDMI IN 3 eARC/ARC)
HDMI IN 3 and 4 support 120 Hz
DIGITAL AUDIO OUT (OPTICAL) / S-CENTER
SPEAKER IN
Two channel linear PCM: 48 kHz 16 bits, Dolby
Audio, DTS
USB 1/2
USB 1 (USB 2.0, 500 mA), USB 2 (USB 3.2 Gen 1, 900 mA)
LAN (10BASE-T/100BASE-TX)

Power and others

Power requirements
110 V – 240 V AC, 50/60 Hz
Screen size (measured diagonally) (Approx.) (inches/cm)
K-75XR71 / 75XR70: 75 / 189.3
K-65XR71 / 65XR70: 65 / 163.9
K-55XR71 / 55XR70: 55 / 138.8
Power consumption
Indicated on the rear of the TV
Standby power consumption*2*3 (W)
0.5
Display resolution (horizontal × vertical) (pixels)
3 840 × 2 160
Output rating
500 mA (for USB 1), 900 mA (for USB 2)

Others

Operating temperature
0 °C – 45 °C
Optional accessories
Camera and Microphone Unit: CMU-BC1

- *1 Except in Power Saving Mode.
- *2 Specified standby power is reached after the TV finishes necessary internal processes.
- *3 Standby power consumption will increase when your TV is connected to the network.

Note

- Optional accessories availability depends on countries/region/TV model/stock.
- Design and specifications are subject to change without notice.
- Subscriptions for services and applications may be required and additional terms, conditions and/or charges may apply when using Google Assistant.
- Power consumption will increase when the built-in MIC is enabled as it is always listening.
- Visit Sony website for more information on product specifications.

Trademark Information

- Dolby, Dolby Vision, Dolby Atmos, Dolby Audio, and the double-D symbol are trademarks of Dolby Laboratories Licensing Corporation. Manufactured under license from Dolby Laboratories. Confidential unpublished works. Copyright © 1992-2022 Dolby Laboratories. All rights reserved.

- Gracenote, the Gracenote logo and logotype, “Powered by Gracenote” logo are either registered trademarks or trademarks of Gracenote, Inc. in the U.S.A. and/or other countries.
- Manufactured under license from IMAX Corporation. IMAX® is a registered trademark of IMAX Corporation in the United States and/or other countries. For DTS patents, see <http://patents.dts.com>. Manufactured under license from DTS, Inc. DTS, DTS:X and the DTS, DTS:X logos are registered trademarks or trademarks of DTS, Inc. in the United States and other countries. © 2024 DTS, Inc. ALL RIGHTS RESERVED.
- TUXERA is a registered trademark of Tuxera Inc. in the US and other countries.

