

# SIEMENS

WNE4A2UPIN

# Washer dryer



**EN** User manual and installation instructions



**Further information and explanations are available online:**



## Table of contents

<b>1 Safety .....</b>	<b>4</b>	<b>8 Buttons .....</b>	<b>23</b>
1.1 General information.....	4	<b>9 Programmes .....</b>	<b>25</b>
1.2 Intended use.....	4	<b>10 Accessories .....</b>	<b>29</b>
1.3 Restriction on user group.....	4	<b>11 Laundry .....</b>	<b>29</b>
1.4 Safe installation .....	5	11.1 Preparing the laundry.....	29
1.5 Safe use .....	6	<b>12 Detergents and care products .....</b>	<b>29</b>
1.6 Safe cleaning and maintenance.....	9	<b>13 Basic operation .....</b>	<b>30</b>
<b>2 Preventing material damage ....</b>	<b>10</b>	13.1 Switching on the appliance... ..	30
<b>3 Environmental protection and saving energy.....</b>	<b>11</b>	13.2 Setting a programme .....	30
3.1 Disposing of packaging .....	11	13.3 Adjusting the programme settings .....	30
3.2 Save energy and conserve resources.....	11	13.4 Loading laundry.....	30
3.3 Energy saving mode .....	11	13.5 Adding detergent and care product .....	30
<b>4 Installation and connection.....</b>	<b>12</b>	13.6 Starting the programme .....	30
4.1 Unpacking the appliance .....	12	13.7 Soaking laundry.....	31
4.2 Contents of package.....	12	13.8 Adding laundry .....	31
4.3 Requirements for the installation location .....	12	13.9 Cancelling the washing programme .....	31
4.4 Removing the transit bolts .....	13	13.10 Cancelling the drying programme .....	31
4.5 Connecting the appliance .....	14	13.11 Resuming the programme when the programme status is Rinse Hold .....	31
4.6 Aligning the appliance.....	15	13.12 Unloading the laundry.....	32
<b>5 Familiarising yourself with your appliance.....</b>	<b>17</b>	13.13 Switching off the appliance.....	32
5.1 Appliance .....	17	<b>14 Childproof lock.....</b>	<b>32</b>
5.2 Detergent drawer.....	17	14.1 Activating the childproof lock.....	32
5.3 Control panel.....	18	14.2 Deactivating the childproof lock.....	32
<b>6 Before using for the first time ..</b>	<b>19</b>		
6.1 Starting an empty washing cycle .....	19		
<b>7 Display .....</b>	<b>20</b>		

<b>15 Basic settings.....</b>	<b>33</b>
15.1 Overview of the basic settings.....	33
15.2 Changing the basic settings.....	34
<b>16 Cleaning and servicing.....</b>	<b>34</b>
16.1 Cleaning the drum.....	34
16.2 Cleaning the detergent drawer.....	34
16.3 Cleaning the drain pump.....	35
<b>17 Troubleshooting.....</b>	<b>39</b>
17.1 Emergency release .....	49
<b>18 Transportation, storage and disposal .....</b>	<b>49</b>
18.1 Removing the appliance .....	49
18.2 Inserting the transit bolts.....	49
18.3 Using the appliance again ...	49
18.4 Disposing of old appliance ...	50
<b>19 Customer Service.....</b>	<b>51</b>
19.1 Product number (E-Nr.) and production number (FD).....	51
<b>20 Technical data .....</b>	<b>51</b>



# 1 Safety

---

Observe the following safety instructions.

## 1.1 General information



- Read this instruction manual carefully.
- Keep the instruction manual and the product information safe for future reference or for the next owner.
- Do not connect the appliance if it has been damaged in transit.

## 1.2 Intended use

Only use this appliance:

- for washing machine-washable fabrics and hand-washable wool in accordance with the care label.
- with tap water and commercially available detergents and care products suitable for washing machines.
- for drying and freshening up fabrics that are washed with water and suitable for dryers.
- in private households and in enclosed spaces in a domestic environment.
- up to an altitude of max. 4000 m above sea level.

## 1.3 Restriction on user group

This appliance may be used by children aged 8 or over and by people who have reduced physical, sensory or mental abilities or inadequate experience and/or knowledge, provided that they are supervised or have been instructed on how to use the appliance safely and have understood the resulting dangers.

Do not let children play with the appliance.

Cleaning and user maintenance must not be performed by children unless they are being supervised.

Keep children under the age of 3 years and pets away from the appliance.

## 1.4 Safe installation

### **WARNING – Risk of electric shock!**

Incorrect installation is dangerous.

- ▶ Connect and operate the appliance only in accordance with the specifications on the rating plate.
- ▶ Connect the appliance to a power supply with alternating current only via a properly installed socket with earthing.
- ▶ The protective conductor system of the domestic electrical installation must be properly installed. The installation must have a sufficiently large cross section.
- ▶ When using a residual current circuit breaker, only use a type with the  mark.
- ▶ Never equip the appliance with an external switching device, e.g. a timer or remote control.
- ▶ Never connect the appliance to a circuit that is regularly switched on and off by the energy supplier.
- ▶ When the appliance is installed, the mains plug of the power cord must be freely accessible. If free access is not possible, an all-pole isolating switch must be installed in the permanent electrical installation according to the installation regulations.
- ▶ When installing the appliance, check that the power cable is not trapped or damaged.

If the insulation of the power cord is damaged, this is dangerous.

- ▶ Never let the power cord come into contact with hot appliance parts or heat sources.
- ▶ Never let the power cord come into contact with sharp points or edges.
- ▶ Never kink, crush or modify the power cord.

### **WARNING – Risk of fire!**

It is dangerous to use an extended power cord and non-approved adapters.

- ▶ Do not use extension cables or multiple socket strips.
- ▶ Only use adapters and power cords approved by the manufacturer.

- ▶ If the power cord is too short and a longer one is not available, please contact an electrician to have the domestic installation adapted.

**⚠ WARNING – Risk of injury!**

The high weight of the appliance may result in injury when lifted.

- ▶ Do not lift the appliance on your own.

**⚠ WARNING – Risk of suffocation!**

Children may put packaging material over their heads or wrap themselves up in it and suffocate.

- ▶ Keep packaging material away from children.
- ▶ Do not let children play with packaging material.

**⚠ CAUTION – Risk of injury!**

The appliance may vibrate or move when in use.

- ▶ Place the appliance on a clean, even, solid surface.
  - ▶ Align the appliance using the appliance feet and a spirit level.
- If hoses and power cords have been laid incorrectly, this causes a tripping hazard.

- ▶ Lay hoses and power cords in such a way that there is no risk of tripping.

If the appliance is moved by holding onto protruding components, such as the appliance door, the parts may break off.

- ▶ Do not move the appliance by holding onto protruding parts.

**⚠ CAUTION – Risk of cutting!**

Touching sharp edges on the appliance may lead to cuts.

- ▶ Do not touch the sharp edges on the appliance.
- ▶ Wear protective gloves when installing and transporting the appliance.

## 1.5 Safe use

**⚠ WARNING – Risk of electric shock!**

If the appliance or the power cord is damaged, this is dangerous.

- ▶ Never operate a damaged appliance.
- ▶ Never pull on the power cord to unplug the appliance. Always unplug the appliance at the mains.

- ▶ If the appliance or the power cord is damaged, immediately unplug the power cord or switch off the fuse in the fuse box and turn off the water tap.
- ▶ Call customer services. → *Page 51*

An ingress of moisture can cause an electric shock.

- ▶ Only use the appliance in enclosed spaces.
- ▶ Never expose the appliance to intense heat or humidity.
- ▶ Do not use steam- or high-pressure cleaners, hoses or sprays to clean the appliance.

### **⚠ WARNING – Risk of harm to health!**

Children can lock themselves in the appliance, thereby putting their lives at risk.

- ▶ Do not install the appliance behind a door as this may obstruct the appliance door or prevent it from opening.
- ▶ With redundant appliances, unplug the power cord. Then cut through the cord and damage the lock on the appliance door beyond repair so that the appliance door will no longer close.

### **⚠ WARNING – Risk of suffocation!**

Children may breathe in or swallow small parts, causing them to suffocate.

- ▶ Keep small parts away from children.
- ▶ Do not let children play with small parts.

### **⚠ WARNING – Risk of explosion!**

If there is coal dust or flour in the air around the appliance, this may cause an explosion.

- ▶ Keep the area around the appliance clean during operation.

### **⚠ WARNING – Risk of poisoning!**

Detergents and care products may result in poisoning if consumed.

- ▶ If accidentally swallowed, seek medical advice.
- ▶ Keep detergents and care products out of the reach of children.

**⚠ WARNING – Risk of explosion!**

Highly flammable objects such as lighters or matches may ignite during the drying process.

- ▶ Remove all highly flammable objects from any pockets in your laundry before the drying process.

Unwashed laundry that has come into contact with solvents, oil, wax, wax remover, paint, grease or stain remover may ignite when drying is in progress.

- ▶ Do not place laundry in this appliance to be dried if the laundry has not been washed first.
- ▶ Rinse the laundry thoroughly with warm water and detergent before drying it in the machine.
- ▶ Do not use the appliance if industrial chemicals have been used to clean the laundry beforehand.

Laundry that has been pretreated with cleaning agents that contain solvents may cause an explosion in the appliance.

- ▶ Rinse pretreated laundry thoroughly with water before washing.

**⚠ WARNING – Risk of fire!**

If drying is interrupted early, the laundry is not cooled sufficiently and may ignite.

- ▶ Do not interrupt the drying programme early.
- ▶ If drying is interrupted early, remove the laundry immediately and spread it out.

**⚠ CAUTION – Risk of injury!**

The covering plate may break if you stand on or climb onto the appliance.

- ▶ Do not stand on or climb onto the appliance.

The appliance may tip over if you sit on or lean against the open door.

- ▶ Do not sit on or lean against the appliance door.
- ▶ Do not place any objects on the appliance door.

Reaching into the drum while it is still turning may cause hand injuries.

- ▶ Wait for the drum to come to a complete stop before reaching inside.



**⚠ CAUTION – Risk of scalding!**

When you wash at high temperatures, the detergent solution gets hot.

- ▶ Do not touch the hot detergent solution.

**⚠ CAUTION – Risk of chemical burns!**

If the detergent drawer is opened, detergent and care products may spray out from the appliance. Contact with eyes or skin may cause irritation.

- ▶ Rinse eyes and/or skin thoroughly with clean water if they come into contact with detergents or care products.
- ▶ If accidentally swallowed, seek medical advice.
- ▶ Keep detergents and care products out of the reach of children.

**1.6 Safe cleaning and maintenance****⚠ WARNING – Risk of electric shock!**

Incorrect repairs are dangerous.

- ▶ Repairs to the appliance should only be carried out by trained specialist staff.
- ▶ Only use genuine spare parts when repairing the appliance.
- ▶ If the power cord of this appliance is damaged, it must be replaced by the manufacturer, the manufacturer's Customer Service or a similarly qualified person in order to prevent any risk.

An ingress of moisture can cause an electric shock.

- ▶ Do not use steam- or high-pressure cleaners, hoses or sprays to clean the appliance.

**⚠ WARNING – Risk of injury!**

The use of non-original spare parts and non-original accessories is dangerous.

- ▶ Only use the manufacturer's original spare parts and original accessories.

**⚠ WARNING – Risk of poisoning!**

Poisonous fumes may be given off if you use cleaning agents that contain solvents.

- ▶ Do not use cleaning agents that contain solvents.

## 2 Preventing material damage

### ATTENTION!

The functionality of the appliance may be impaired if you use the wrong quantity of fabric softener, detergent, care product or cleaning agent.

- ▶ Follow the dosage recommendations from the manufacturer.

Exceeding the maximum load capacity impairs the function of the appliance.

- ▶ Observe the maximum load capacity for each programme and do not exceed it.

→ "Programmes", Page 25

Foam and foam rubber may deform or melt during the drying process.

- ▶ Do not dry laundry that contains foam or foam rubber.

The appliance is secured for transportation using transit bolts. Transit bolts which have not been removed may result in material damage and damage to the appliance.

- ▶ Before starting up the appliance, remove the transit bolts completely and keep them in a safe place.
- ▶ Before transport, fit the transit bolts fully in order to prevent damage in transit.

Material damage may be caused if the water inlet hose is connected incorrectly.

- ▶ Tighten the screw connections on the water inlet until they are hand-tight.
- ▶ Connect the water inlet hose directly to the water tap, without any additional connecting elements such as adapters, extensions or valves.
- ▶ Ensure that the inner diameter of the water tap is at least 17 mm.

- ▶ Make sure that the length of the thread on the connection to the water tap is at least 10 mm.

If the water pressure is too high or too low, the appliance may not be able to operate properly.

- ▶ Ensure that the water pressure in the water supply system is at least 30 kPa (0.3 bar) and max. 1000 kPa (10 bar).
- ▶ If the water pressure exceeds the maximum value specified, a pressure-reducing valve must be installed between the drinking water connection and the hose set of the appliance.
- ▶ Do not connect the appliance to the mixer tap of an unpressurised hot-water boiler.

Modified or damaged water hoses may result in material damage and damage to the appliance.

- ▶ Never kink, crush, modify or cut through water hoses.
- ▶ Only use the water hoses supplied with the appliance or genuine spare hoses.
- ▶ Never re-use water hoses that have been used before.

Operating the appliance using water that is dirty or too hot may lead to material damage and damage to the appliance.

- ▶ Only operate the appliance with cold mains water.

Unsuitable cleaning products may damage the surfaces of the appliance.

- ▶ Do not use harsh or abrasive detergents.
- ▶ Do not use cleaning products with a high alcohol content.
- ▶ Do not use hard scouring pads or cleaning sponges.
- ▶ Clean the appliance with nothing but water and a soft, damp cloth.

- ▶ Remove all detergent residue, spray residue or other residues immediately if they come into contact with the appliance.

---

## 3 Environmental protection and saving energy

### 3.1 Disposing of packaging

The packaging materials are environmentally compatible and can be recycled.

- ▶ Sort the individual components by type and dispose of them separately.

### 3.2 Save energy and conserve resources

If you follow these instructions, your appliance will use less electricity and less water.

Choose programmes with low temperatures and longer wash times and use maximum load capacity.

- ✓ Energy consumption and water consumption is most efficient.

Add detergent based on the laundry's degree of soiling.

- ✓ For light to normal soiling, a smaller amount of detergent is sufficient. Observe the dosage recommendation from the detergent manufacturer.

Reduce the washing temperature for lightly and normally soiled laundry.

- ✓ At lower temperatures, the appliance consumes less energy. For light to normal soiling, lower temperatures than indicated on the care label are also sufficient.

Set the maximum spin speed if you want to dry the laundry in the appliance afterwards.

- ✓ The drier the laundry, the shorter the programme duration when drying which, in turn, reduces energy consumption. A higher spin speed reduces the residual moisture in the laundry and increases the volume of the spin noise.

Wash the laundry without prewash.

- ✓ Washing with prewash increases the programme duration and increases energy and water consumption.

The appliance has a continuous automatic load adjustment function.

- ✓ Depending on the type of fabric and load capacity, the continuous automatic load adjustment function optimally adjusts the water consumption and programme duration.

### 3.3 Energy saving mode

If you do not use the appliance for an extended period, it automatically switches to energy-saving mode.

Energy-saving mode ends when you use the appliance again.

---

## 4 Installation and connection

### 4.1 Unpacking the appliance

#### ATTENTION!

Objects remaining in the drum that are not designed for operation with the appliance may cause material damage and damage to the appliance.

- ▶ Remove these objects, along with all supplied accessories, from the drum before starting the appliance.

1. Remove any packaging and protective covers completely from the appliance.

→ *"Disposing of packaging"*, Page 11

2. Check the appliance for visible damage.
3. Open the door.
4. Remove any accessories from the drum.
5. Close the door.

### 4.2 Contents of package

After unpacking all parts, check for any damage in transit and completeness of the delivery.

#### ATTENTION!

If the appliance is operated with incomplete or defective accessories, the appliance may not be able to operate properly, or this may result in material damage or damage to the appliance.

- ▶ Do not operate the appliance with incomplete or defective accessories.

- ▶ Replace the accessories in question before operating the appliance.  
→ *"Accessories"*, Page 29

**Note:** The appliance has been tested at the factory to check it is in working order. As a result, water stains may remain in the appliance. These marks will disappear after the first wash cycle.

The delivery consists of the following:

- Washer dryer
- Accompanying documents
- Transit bolts  
→ *"Removing the transit bolts"*, Page 13
- Cover caps
- Water inlet hose  
→ *"Connecting the water inlet hose"*, Page 14

### 4.3 Requirements for the installation location



#### WARNING

##### Risk of electric shock!

The appliance contains live parts. Touching live parts is dangerous.

- ▶ Do not operate the appliance without a cover cap.



#### WARNING

##### Risk of injury!

When using the appliance on a base, the appliance may tip over.

- ▶ Always secure the feet of the appliance to a base using the manufacturer's fixing brackets → *Page 29* before using the appliance for the first time.

**ATTENTION!**

If residual water in the appliance freezes, this may cause damage to the appliance.

- ▶ Do not install or operate this appliance anywhere that is liable to experience frost or outdoors.

If the appliance is tilted at an angle greater than 40°, residual water may leak out of the appliance and cause material damage.

- ▶ Tilt the appliance carefully.
- ▶ Transport the appliance in an upright position.

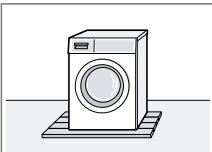
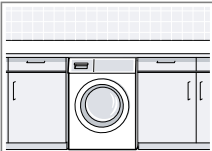
Installation location	Requirements
<p>Base</p> 	<p>Secure the appliance with fixing brackets → Page 29.</p>
<p>Wooden joist floor</p> 	<p>Place the appliance on a water-resistant wooden board (minimum thickness of 30 mm) which is screwed tightly to the floor.</p>
<p>Kitchen unit</p> 	<p>Only install the appliance underneath a continuous worktop that is securely connected to adjacent cabinets. Required niche width: 60 cm.</p>

**Installation location Requirements**

Against a wall

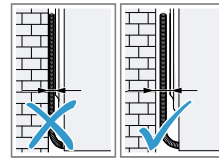

Do not trap the power cord or the hoses between the wall and the appliance.

**4.4 Removing the transit bolts**

The appliance is secured for transportation using transit bolts on the rear of the appliance.

**Note:** Keep the transit bolt screws and the sleeves in a safe place for future transport.

→ "Inserting the transit bolts", Page 49

1. Pull the hoses out of the holders.

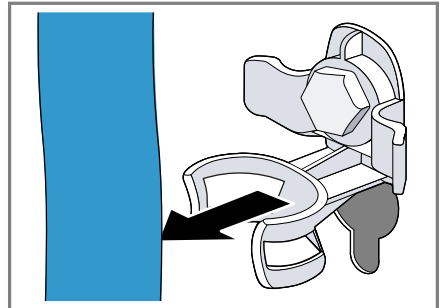

en Installation and connection

2. Unscrew ① and remove ② all of the screws for the 4 transit bolts using a WAF 13 wrench.

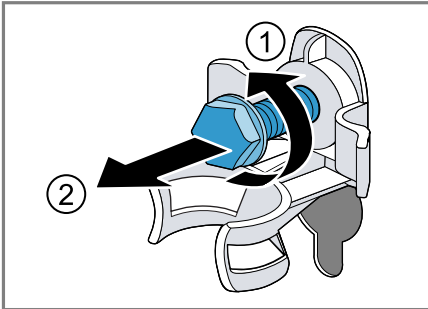

3. Remove the power cable from the holder.

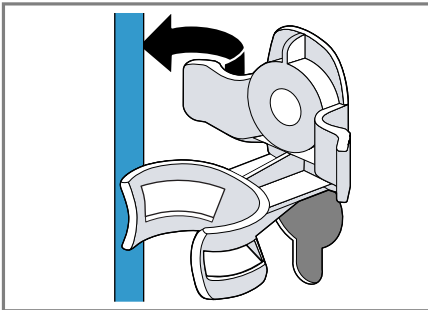

4. Remove the 4 sleeves.

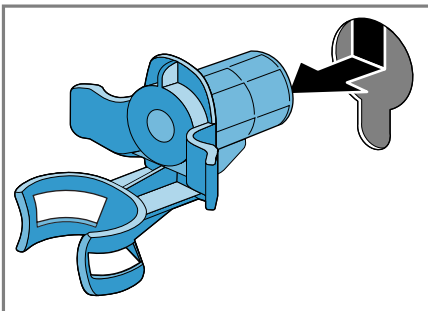

5. Put on the 4 cover caps.

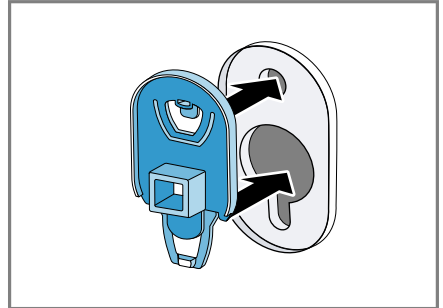

6. Push the 4 cover caps downwards.

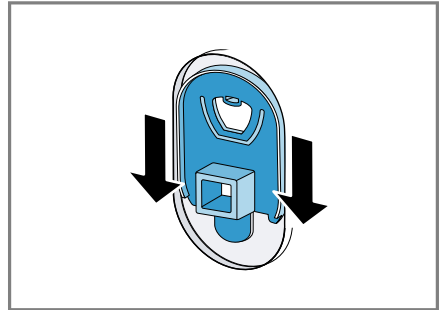

**Note:** To install the transit bolts to transport the appliance, perform these steps again in the reverse order.

## 4.5 Connecting the appliance

### Connecting the water inlet hose

1. Connect the water inlet hose.

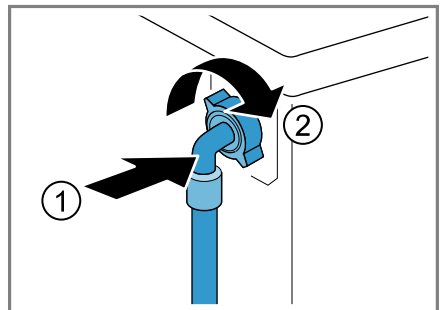

2. Connect the water inlet hose to a tap (26.4 mm = 3/4").

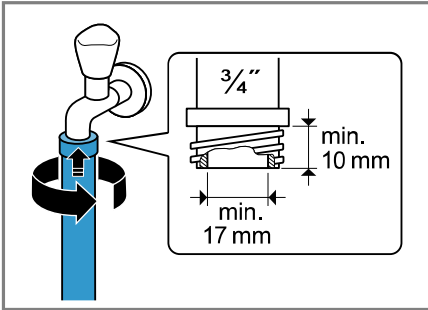

3. Open the water tap carefully and check that the connection points are tight.

### Water outlet connection types

This information is intended to help you to connect this appliance to the water outlet.

#### ATTENTION!

When draining, the water outlet hose is subject to water pressure and may come loose from the installed connection point.

- ▶ Secure the water outlet hose against unintentional loosening.

**Note:** Observe the draining heights. The draining heights are: minimum: 60 cm, maximum: 100 cm

#### Siphon

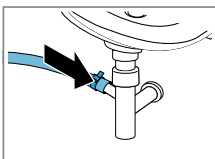

Secure the connection point with a (24–40 mm) hose clamp.

#### Sink

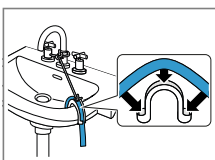

Fix and secure the water outlet hose with an elbow.  
→ "Accessories", Page 29

Plastic pipe with rubber sleeve

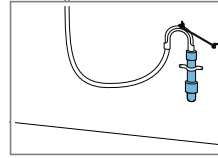

Fix and secure the water outlet hose with an elbow.  
→ "Accessories", Page 29

### Connecting the appliance to the electricity supply

**Note:** Your electrical domestic installation for this appliance must comply with the local legal provisions and safety regulations, and should include a residual current circuit-breaker.

1. Insert the mains plug of the appliance's power cable in a socket nearby.

The connection details of the appliance can be found under Technical data → Page 51.

2. Check the mains plug is inserted properly.

### 4.6 Aligning the appliance

In order to reduce noise and vibration and to prevent the appliance from moving, align the appliance correctly.

1. Use a WAF 17 wrench to loosen the lock nuts in a clockwise direction.

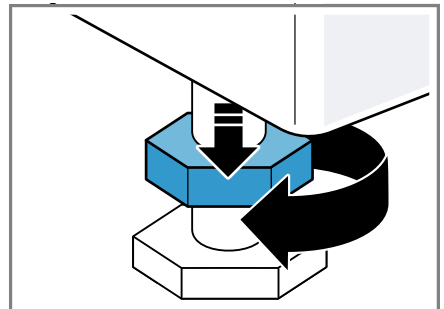

**en** Installation and connection

2. To align the appliance, turn the appliance feet. Check that the appliance is level using a spirit level.

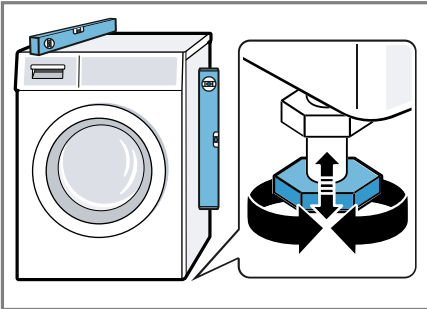

All appliance feet must stand firmly on the ground.

3. Use a WAF 17 wrench to tighten the lock nuts against the housing until they are hand-tight.

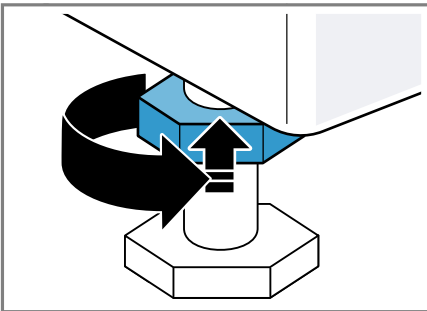

In doing so, hold the foot tight and do not adjust its height.



## 5 Familiarising yourself with your appliance

### 5.1 Appliance

You can find an overview of the parts of your appliance here.



On certain models, specific details such as the colour and shape may differ from those pictured.

- |   |  |
|---|--|
| 1 | Maintenance flap for the drain pump → <i>Page 35</i> |
| 2 | Door   |
| 3 | Detergent drawer → <i>Page 17</i>                    |
| 4 | Control panel → <i>Page 18</i>                       |
| 5 | Water outlet hose → <i>Page 15</i>                   |
| 6 | Power cord → <i>Page 15</i>                          |
| 7 | Transit bolts → <i>Page 13</i>                       |

### 5.2 Detergent drawer

**Note:** Observe the manufacturer's instructions on the use and dosage of the detergent and care product and the information in the programme descriptions.

en Familiarising yourself with your appliance

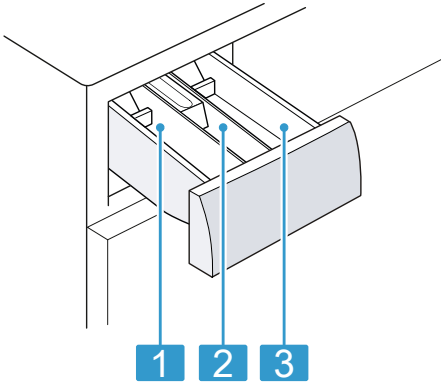

- 1** Dispenser II: detergent for the main wash
- 2** Compartment : Fabric softener
- 3** Compartment I: Detergent for prewash

### 5.3 Control panel

You can use the control panel to configure all functions of your appliance and to obtain information about the operating status.

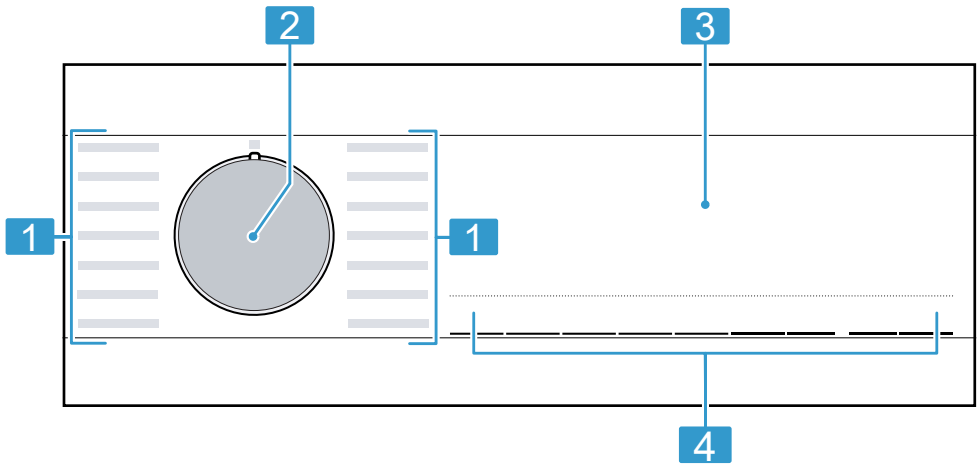

- 1** Programmes → *Page 25*
- 2** Programme selector → *Page 30*
- 3** Display → *Page 20*
- 4** Buttons → *Page 23*

## 6 Before using for the first time

Prepare the appliance for use.

### 6.1 Starting an empty washing cycle

Your appliance was inspected thoroughly before leaving the factory. To remove any residual water, run the first wash cycle without any laundry.

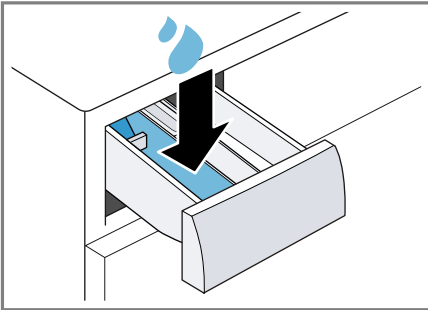

1. Turn the programme selector to  **Drum Clean**.
2. Close the door.
3. Pull out the detergent drawer.
4. Pour approx. 1 litre of tap water into compartment II.

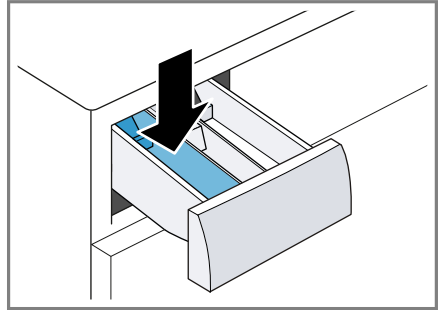

5. Add washing powder that contains a bleaching agent to compartment II.



To prevent foaming, use only half of the amount of detergent recommended by the detergent manufacturer for light soiling. Do not use detergent suitable for woollens or delicates.

6. Push in the detergent drawer.
7. Press  **Start/Reload** to start the programme.
  - ✓ The display shows the remaining programme duration.
  - ✓ After the programme has ended, the display shows: End.
8. Start the first wash cycle or set the programme selector to  to switch off the appliance.
  - "Basic operation", Page 30

## 7 Display



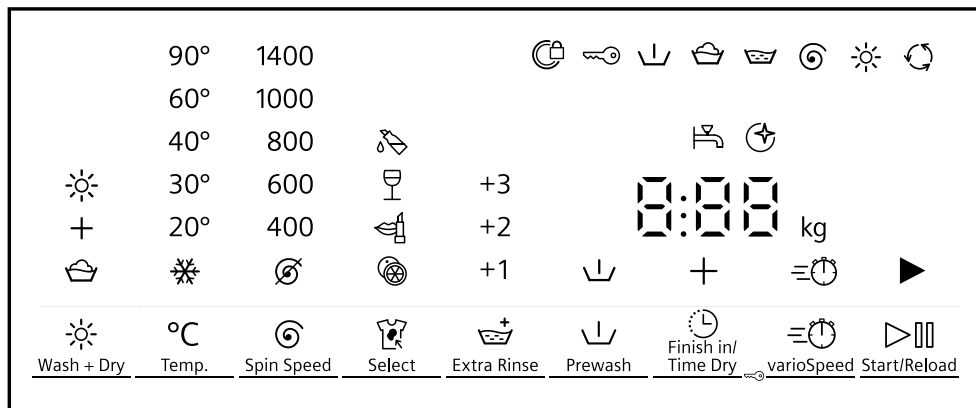









The display shows the current settings, options or relevant information.







Example: Display

Display	Description
0:40 <sup>1</sup>	Expected programme duration or programme time remaining in hours and minutes.
+8h <sup>1</sup>	Program end time → "Buttons", Page 23
6.0 <sup>1</sup>	Recommendation for the maximum load capacity for the selected program in kg.
☉ - 1400	Set spin speed in rpm. → "Buttons", Page 23 ☉ : No spin cycle, draining only
☼ - 90	Set temperature in °C. → "Buttons", Page 23 ☼ (cold)
▶	Start, cancel or pause <ul style="list-style-type: none"> <li>■ Lights up: The programme is running and can be cancelled or paused.</li> <li>■ Flashes: The programme can be started or continued.</li> </ul>
⏴	Prewash Programme status
🪣	Wash Programme status
🪣	Rinse Programme status

<sup>1</sup> Example

Display	Description
	Spin Programme status
End	Program end Programme status
	Drying Programme status
	Crease-reduction function Programme status
	<ul style="list-style-type: none"> <li>■ Lights up: The childproof lock is activated.</li> <li>■ Flashes: The childproof lock is activated and the appliance has been operated.</li> </ul> → "Deactivating the childproof lock", Page 32
+1 +2 +3	Additional rinse cycles are activated. → "Buttons", Page 23
	Washing with subsequent drying is activated. → "Buttons", Page 23
	Washing is activated. → "Buttons", Page 23
	Drying is activated. → "Buttons", Page 23
	Prewash is activated. → "Buttons", Page 23
Hot	The cooling process cools the laundry for a few minutes while the drum is rotating, in order to avoid damage to the laundry. <b>Note:</b> Do not interrupt the cooling process, and wait for the door lock to open.
- - -	Rinse Hold is activated.
	Shortened programme length is activated. → "Buttons", Page 23
	Cosmetics The stain type is activated.
	Orange The stain type is activated.
	Red wine The stain type is activated.
	Cooking fat/cooking oil The stain type is activated.

<sup>1</sup> Example

Display	Description
	Flashes: Drum cleaning is required. Run the  Drum Clean programme for cleaning and caring for the drum and the outer tub. → "Cleaning the drum", Page 34
	<ul style="list-style-type: none"> <li>■ Lights up: The door is locked and cannot be opened.</li> <li>■ Flashes: The door is not closed properly.</li> <li>■ Off: The door is unlocked and can be opened.</li> </ul>
	<ul style="list-style-type: none"> <li>■ No water pressure.</li> <li>■ The water pressure from the tap is too low.</li> </ul>
E:35 / -10 <sup>1</sup>	Error code, error display, signal. → "Troubleshooting", Page 39
<sup>1</sup> Example	

## 8 Buttons

The selection of programme settings depends on the programme that is set.





Button	Selection	Description
°C Temp.	- 90	Adjust the temperature. Set temperature in °C.
Spin Speed	- 1400	Adjust the spin speed or deactivate the spin cycle. Set spin speed in rpm. If  is selected, the water is drained and the spin cycle is deactivated. The laundry stays wet inside the drum.
Start/Re-load	<ul style="list-style-type: none"> <li>■ Start</li> <li>■ Cancel</li> <li>■ Pause</li> </ul>	Start, cancel or pause the programme.
Finish in/Time Dry	Up to 24 hours	Set the programme end time. The programme duration is already included in the set number of hours. Once the programme has started, the programme duration is displayed.
varioSpeed	<ul style="list-style-type: none"> <li>■ Activate</li> <li>■ Deactivate</li> </ul>	Activate or deactivate a shorter programme duration. <b>Note:</b> Energy consumption increases. The washing result is not affected by this.
Prewash	<ul style="list-style-type: none"> <li>■ Activate</li> <li>■ Deactivate</li> </ul>	Activate or deactivate prewash, e.g. for washing heavily soiled laundry.
Extra Rinse	<ul style="list-style-type: none"> <li>■ +1</li> <li>■ +2</li> <li>■ +3</li> </ul>	Activate or deactivate up to three additional rinse cycles. Recommended for particularly sensitive skin or in regions with very soft water.
varioSpeed and  Finish in/Time Dry	<ul style="list-style-type: none"> <li>■ Activate</li> <li>■ Deactivate</li> </ul>	→ "Childproof lock", Page 32
Select	Multiple selection	Select the type of stain. The temperature, drum movement and soaking time are all adjusted to suit the type of stain.
Wash+Dry	<ul style="list-style-type: none"> <li>■ </li> <li>■ </li> <li>■ </li> </ul>	<ul style="list-style-type: none"> <li>■ When  is selected, only washing is activated.</li> </ul>

Button	Selection	Description
		<ul style="list-style-type: none"> <li>■ When ☼+👤 is selected, washing with subsequent drying is activated.</li> <li>■ When ☼ is selected, only drying is activated.</li> </ul> <p><b>Note:</b> For the adjustable combinations of washing, drying or washing and drying, observe the information for the selected programme. → "Programmes", Page 25</p>



## 9 Programmes







**Note:** The laundry's care labels provide you with additional information on programme selection.

Programme	Description	Max. load (kg) Wash	Max. load (kg) Drying
Cottons 	Wash hard-wearing items made of cotton, linen or blended fabrics. Also suitable as a short programme for normally soiled laundry when you activate  varioSpeed. Programme setting: <ul style="list-style-type: none"> <li>■ Max. 90 °C</li> <li>■ Max. 1400 rpm</li> </ul>	10.5 5.0 <sup>1</sup>	6.0
Synthetics 	Wash items made from synthetic or blended fabrics. Programme setting: <ul style="list-style-type: none"> <li>■ Max. 60 °C</li> <li>■ Max. 1400 rpm</li> </ul>	4.0	2.5
 Bedsheets Curtains	Wash items made from synthetic or blended fabrics. Suitable for large items of laundry, e.g. bedding, throws, sofa covers, bed covers, and easy-care curtains. <b>Note:</b> Do not machine-wash items that have lace embroidery or glued-on or sewn-on decorative elements. Programme setting: <ul style="list-style-type: none"> <li>■ Max. 60 °C</li> <li>■ Max. 1000 rpm</li> </ul>	4.0	- <sup>2</sup>
Mix 	Wash items made from cotton, linen, or synthetic or blended fabrics. Suitable for lightly soiled laundry. Programme setting: <ul style="list-style-type: none"> <li>■ Max. 60 °C</li> <li>■ Max. 1400 rpm</li> </ul>	4.0	2.5

<sup>1</sup>  **varioSpeed** activated

<sup>2</sup> Drying not possible



<sup>3</sup> Washing not possible

Programme	Description	Max. load (kg) Wash	Max. load (kg) Dry-ing
Delicates/ Silk 	<p>Wash delicate, washable items made from silk, viscose and synthetic fabrics. Use a detergent that is suitable for delicates or silk.</p> <p><b>Note:</b> Wash especially delicate items or items with hooks, eyelets or clips in a mesh laundry bag.</p> <p>Programme setting:</p> <ul style="list-style-type: none"> <li>■ Max. 40 °C</li> <li>■ Max. 800 rpm</li> </ul>	2.0	- <sup>2</sup>
 Wool 	<p>Hand- or machine-washable items that are made from wool or contain wool. To prevent the laundry from shrinking, the drum moves the items very gently with long pauses. Use a detergent that is suitable for wool.</p> <p>Programme setting:</p> <ul style="list-style-type: none"> <li>■ Max. 40 °C</li> <li>■ Max. 800 rpm</li> </ul>	2.0	1.0
Rinse 	<p>Rinse and then spin the laundry, and drain the water.</p> <p>Programme setting: Max. 1400 rpm</p>	-	-
Spin 	<p>Spin and drain the water. Do not use fabric softener.</p> <p>Programme setting: Max. 1400 rpm</p>	-	-
 Hygiene	<p>Wash hard-wearing items made from cotton, linen or blended fabrics. Suitable for allergy sufferers and for strict hygiene requirements.</p> <p><b>Note:</b> Once the set temperature has been reached, it remains constant throughout the entire washing process.</p> <p>Programme setting:</p> <ul style="list-style-type: none"> <li>■ Max. 60 °C</li> <li>■ Max. 1400 rpm</li> </ul>	6.5	5.0

<sup>1</sup>  **varioSpeed** activated

<sup>2</sup> Drying not possible





<sup>3</sup> Washing not possible

Programme	Description	Max. load (kg) Wash	Max. load (kg) Dry-ing
 Down Wear	<p>Wash pillows, duvets or clothing stuffed with down and fillings with synthetic fibres. Wash large items separately. Use a detergent that is suitable for down or delicates. Use sparingly. Do not use fabric softener.</p> <p><b>Note:</b> To prevent excessive foaming, remove air from laundry items by rolling them up before you wash them.</p> <p>Programme setting:</p> <ul style="list-style-type: none"> <li>■ Max. 60 °C</li> <li>■ Max. 1000 rpm</li> </ul>	2.0	2.0
 Drum Clean	<p>Clean and care for the drum. After cleaning, the residual water in the drum is removed by supplying hot air. Use this programme in the following cases:</p> <ul style="list-style-type: none"> <li>■ Before using the appliance for the first time</li> <li>■ If you regularly wash at temperatures of 40 °C or lower</li> <li>■ After a prolonged period of non-use</li> </ul> <p>Use washing powder that contains bleach. Add the washing powder containing bleach to compartment II for the main wash. → "Detergent drawer", Page 17</p> <p>Halve the amount of detergent to avoid foaming. Do not use fabric softener. Do not use liquid detergent or detergent that is intended for woollens or delicates.</p> <p><b>Note:</b> The drum cleaning indicator flashes to remind you if you have not used a programme at 60 °C or higher for a long time.</p>	– <sup>3</sup>	– <sup>2</sup>
 Refresh	<p>Reduce creases and airborne odours in suits and fabrics made of cotton and down.</p> <p><b>Tip:</b> To prevent creasing, remove the laundry immediately after the programme has ended.</p>	– <sup>3</sup>	1.0

<sup>1</sup>  **varioSpeed** activated

<sup>2</sup> Drying not possible

<sup>3</sup> Washing not possible

Programme	Description	Max. load (kg) Wash	Max. load (kg) Dry-ing
	<p><b>Notes</b></p> <ul style="list-style-type: none"> <li>■ The laundry is not dried or washed.</li> <li>■ If you use the  Refresh programme often without washing in between, this may cause odours in the appliance.</li> </ul>		
 myTime	<p>Wash items made from cotton, linen, or synthetic or blended fabrics. Short programme for items of lightly to normally soiled laundry.</p> <p><b>Note:</b> If you only want to dry the laundry and not wash it, press .</p> <p>Programme setting:</p> <ul style="list-style-type: none"> <li>■ Max. 40 °C</li> <li>■ Max. 1000 rpm</li> </ul>	2.0	6.0
 Wasch & Dry 60 min	<p>Wash and dry items made from cotton, linen, or synthetic or blended fabrics. Short programme for small items of lightly soiled laundry.</p> <p>Programme setting:</p> <ul style="list-style-type: none"> <li>■ Max. 40 °C</li> <li>■ Max. 1000 rpm</li> </ul>	2.0	1.0
<sup>1</sup>  <b>varioSpeed</b> activated			
<sup>2</sup> Drying not possible			
<sup>3</sup> Washing not possible			

## 10 Accessories

Use original accessories. These have been made especially for your appliance.

	Use	Order number
Water inlet hose extension	Extend the water inlet hose for cold water or AquaStop (approx. 2.50 m).	WZ10131
Fixing brackets	Improves the stability of the appliance.	WX975600
Elbow	Secure the water outlet hose in place.	00655300
Washing machine cleaners	Cleaning products for maintaining the appliance interior.	00311929

## 11 Laundry

### 11.1 Preparing the laundry

#### ATTENTION!

Objects remaining in the laundry may damage the laundry and the drum.

- ▶ Remove all items from any pockets in your laundry before using the appliance.

#### Note

The appliance and fabrics are protected when you prepare your laundry.

- Brush off sand and soil
- Sort the laundry according to colour and textiles and observe the care labels
- Close all zips, Velcro fasteners, hooks and eyes
- Tie cloth belts, cloth straps and cords together
- Remove curtain fittings and lead strips
- Wash small or particularly delicate items in a mesh washing bag
- Wash large and small items of laundry together
- Wash laundry with fresh stains immediately

- Pretreat laundry with dried stains and wash several times
- Load the laundry unfolded into the drum
- Spin the laundry before drying

## 12 Detergents and care products

The manufacturer's instructions for use and dosage can be found on the packaging.

#### Notes

- When using liquid detergents, only use liquid detergents that are self-flowing
- Do not mix different liquid detergents
- Do not mix detergent and fabric softener
- Do not use products that have expired or are highly congealed
- Do not use products containing solvents, caustic agents or volatile substances
- Use dyes sparingly as salt may damage stainless steel
- Do not use color-bleaching agents in the appliance

---

## 13 Basic operation

### 13.1 Switching on the appliance

**Requirement:** The appliance has been correctly installed and connected.

→ *"Installation and connection", Page 12*

- ▶ Turn the programme selector to a programme.

### 13.2 Setting a programme

1. Turn the programme selector and set the required programme.  
→ *"Programmes", Page 25*
2. If required, adjust the programme settings.  
→ *"Adjusting the programme settings", Page 30*

### 13.3 Adjusting the programme settings

**Requirement:** A programme is set.  
→ *"Setting a programme", Page 30*

- ▶ Adjust the programme settings.  
→ *"Buttons", Page 23*

**Note:** The programme settings are not saved permanently for the programme.

### 13.4 Loading laundry

**Note:** To prevent creasing, note the maximum load for the programmes.  
→ *"Programmes", Page 25*

#### Requirements

- The laundry is prepared and sorted.  
→ *"Laundry", Page 29*
- The drum is empty.

1. Open the door.
2. Place the laundry in the drum.
3. Close the door.

Ensure that there is no laundry trapped in the door.



### 13.5 Adding detergent and care product

**Note:** Observe the information about detergents and care products  
→ *Page 29.*

1. Pull out the detergent drawer.  
→ *"Detergent drawer", Page 17*
2. Pour in detergent.
3. If required, add the care product.
4. Push in the detergent drawer.

### 13.6 Starting the programme

**Requirement:** A programme is set.  
→ *"Setting a programme", Page 30*

1. Press  **Start/Reload**.
  - ✓ The drum rotates and load detection takes place. This can take up to 2 minutes, after which water enters the drum.
  - ✓ The display shows the programme duration or the programme end time.
  - ✓ After the programme has ended, the display shows: End.
2. If the display shows , the laundry is not spun. The water is pumped out after the rinse cycle.

## Notes

- If you do not remove the laundry once the programme has ended, the crease-reduction function starts after 15 minutes and takes approx. 30 minutes. The display shows 0 : 00 , **RRP** , **RD** and End alternately, and  appears. Press any button on the display to cancel the crease-reduction programme and to remove the laundry.
- If "Hot" appears, the appliance cools the laundry. When "Hot" goes out, the laundry has cooled down.

## 13.7 Soaking laundry

**Note:** No additional detergent is required. The washing solution is then used for washing.

1. Start the programme.
2. To pause the programme, after approx. 10 minutes, press **Start/Reload**.
3. To resume the programme, after the desired soaking time, press **Start/Reload**.

## 13.8 Adding laundry

After the programme starts, you can remove or add laundry depending on the programme status.

1. Press **Start/Reload**.  
During the washing cycle, the appliance pauses.  
During the drying cycle, the appliance checks whether it is possible to add laundry.



**Note:** If you want to add laundry, follow the instructions on the display.

→ "Display", Page 22

2. Open the door.
3. Add or remove laundry.

4. Close the door.
5. Press **Start/Reload**.

## 13.9 Cancelling the washing programme

1. Press **Start/Reload**.
2. Open the door.  
The appliance door remains locked for safety reasons if the temperature and water levels are high.
  - If the temperature is high, start the **Rinse**  programme.
  - If the water level is high, start the **Spin**  programme or select a suitable programme for draining.  
→ "Programmes", Page 25
3. Remove the laundry.  
→ "Unloading the laundry", Page 32

## 13.10 Cancelling the drying programme

- ▶ Turn the programme selector to set any other programme.
- ✓ The door lock opens automatically after a cooling period of a few minutes.

## 13.11 Resuming the programme when the programme status is Rinse Hold

### Requirements

- Rinse Stop is activated.
  - The last rinse cycle of the set programme has ended and the laundry is in the rinsing water.
1. Set the **Spin**  programme or a programme for draining the water.  
→ "Programmes", Page 25
  2. Press **Start/Reload**.

## 13.12 Unloading the laundry

1. Open the door.
2. Remove the laundry from the drum.

## 13.13 Switching off the appliance

1. Turn the programme selector to .
2. Turn off the tap.
3. Wipe the rubber gasket dry and remove any foreign objects.

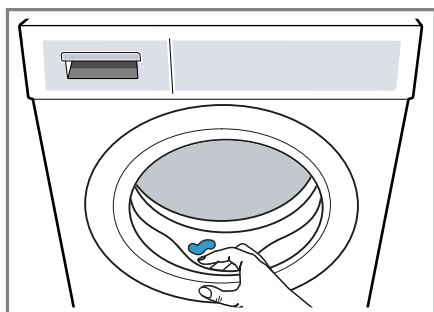



4. Leave the appliance door and detergent drawer open so that residual water can evaporate.

- ✓ The childproof lock remains active even after the appliance has been switched off and in the event of a power cut.

## 14.2 Deactivating the childproof lock

**Requirement:** To deactivate the childproof lock, the appliance must be switched on.



- ▶ Press and hold the two  **varioSpeed** and  **Finish in/Time Dry** buttons for approx. 3 seconds.
- ✓  goes out in the display.

---

## 14 Childproof lock

Secure your appliance against being operated unintentionally using the controls.

### 14.1 Activating the childproof lock

- ▶ Press and hold the two  **varioSpeed** and  **Finish in/Time Dry** buttons for approx. 3 seconds.
- ✓ The display shows .
- ✓ The control elements are locked.



## 15 Basic settings

You can configure the basic settings for your appliance to meet your needs.

### 15.1 Overview of the basic settings

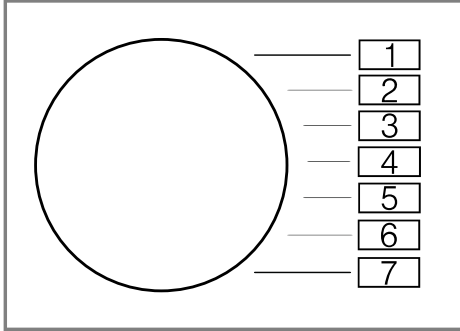

Basic setting	Programme position	Value	Description
End signal	2	0 (off) 1 (quiet) 2 (medium) 3 (loud) 4 (very loud)	Set the volume of the signal at the end of the programme.
Button signal	3	0 (off) 1 (quiet) 2 (medium) 3 (loud) 4 (very loud)	The volume of the audible signal emitted when the buttons are pressed.
Drum cleaning reminder	4	On OFF	Activate or deactivate the reminder to clean the drum.

## 15.2 Changing the basic settings

1. Set the programme selector to position 1.



2. Press **Spin Speed** and, at the same time, turn the programme selector to position 2.
  - ✓ The display shows the current value.
3. Set the programme selector to the required position.  
→ "Overview of the basic settings", Page 33
4. To change the value, press **Finish in/Time Dry**.
5. To save the changes, switch off the appliance.

---

## 16 Cleaning and servicing

To keep your appliance working efficiently for a long time, it is important to clean and maintain it carefully.

### 16.1 Cleaning the drum

#### **⚠ CAUTION** **Risk of injury!**

Permanently washing at low temperatures and a lack of ventilation for the appliance may damage the drum and cause injury.

- ▶ Regularly run a programme for cleaning the drum or wash at temperatures of at least 60 °C.
- ▶ Leave the appliance to dry after every operation with the door open, and leave the detergent drawer to dry.
- ▶ Run the **Drum Clean** programme without laundry and with a cleaning agent for caring for the inside of the appliance  
→ "Accessories", Page 29 or with washing powder that contains bleach.

### 16.2 Cleaning the detergent drawer

1. Pull out the detergent drawer.

2. Press down on the insert and remove the detergent drawer.

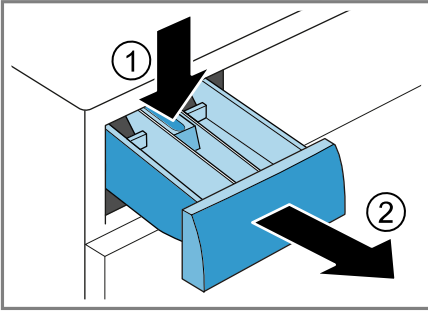

3. Pull out the insert upwards.

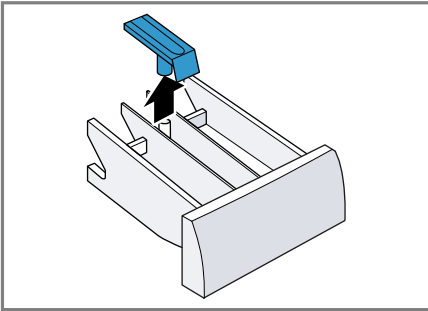

4. Clean the detergent drawer and insert with water and a brush, and then dry them.

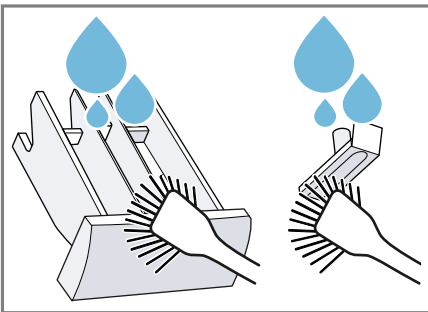

5. Fit the insert and click it into place.

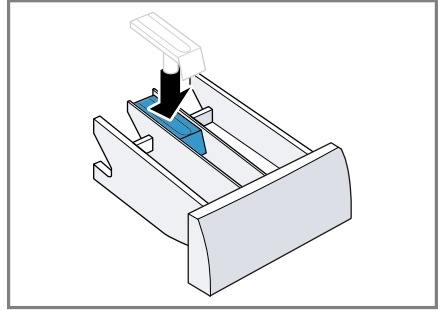

6. Clean the opening for the detergent drawer.

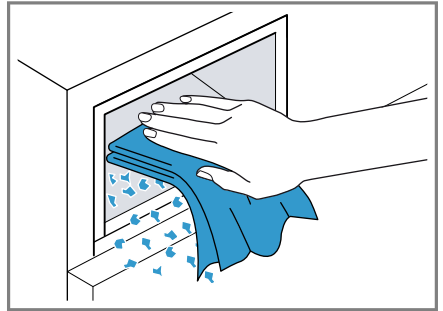

7. Push in the detergent drawer.

## 16.3 Cleaning the drain pump

Clean the drain pump regularly, at least once a year, as well as in the event of faults, e.g. blockages or rattling noises.

### Emptying the drain pump

1. Turn off the tap.
2. Switch off the appliance.  
→ "Switching off the appliance",  
Page 32
3. Disconnect the appliance's mains plug from the power supply.

en Cleaning and servicing

4. Open and remove the maintenance flap.

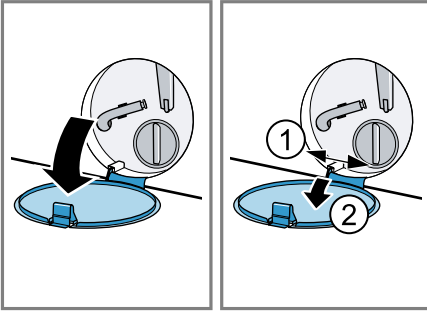

5. Slide a sufficiently large container under the opening.

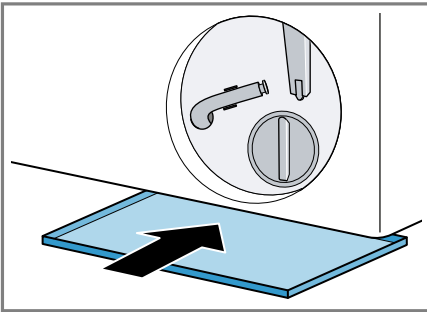

6. Take the drain hose out of the holder.

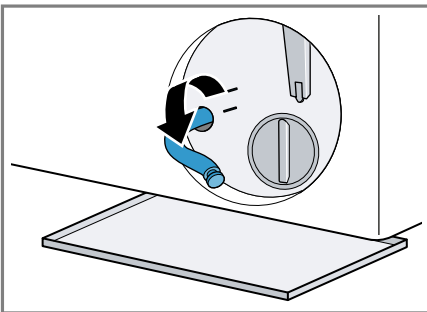

7. **⚠ CAUTION - Risk of scalding!**  
When you wash at high temperatures, the detergent solution gets hot.

- Do not touch the hot detergent solution.

To allow the detergent solution to flow out into the container, remove the sealing cap.

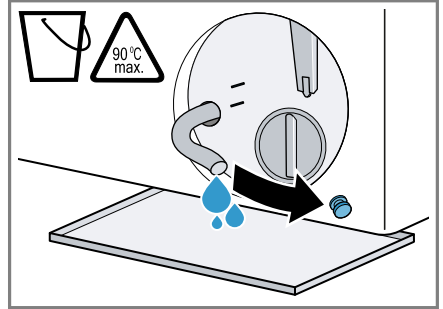

8. Firmly press on the sealing cap.

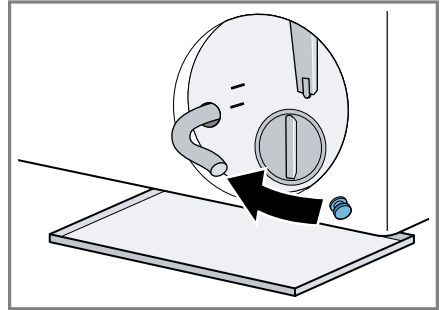

9. Insert the drain hose into the holder.

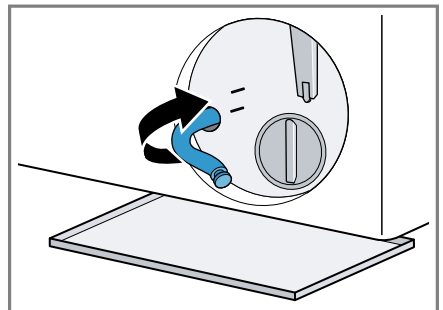

## Cleaning the drain pump

**Requirement:** The drain pump is empty. → Page 35

1. Since water may remain in the drain pump, unscrew the pump cap carefully.
  - The filter insert in the pump housing may become stuck due to coarse particles of dirt. Loosen the dirt and remove the filter insert.

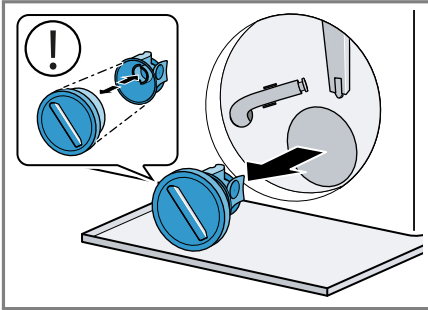

2. Clean the interior, the thread on the pump cap and the pump housing.

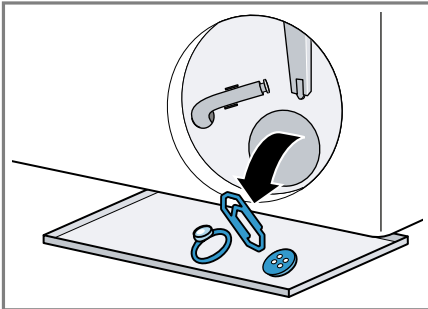

The pump cap is comprised of two parts which can be taken apart for cleaning.

3. Ensure that the impeller in the drain pump can rotate.

4. Insert the pump cap.
  - Ensure that the parts of the pump cap are correctly assembled.

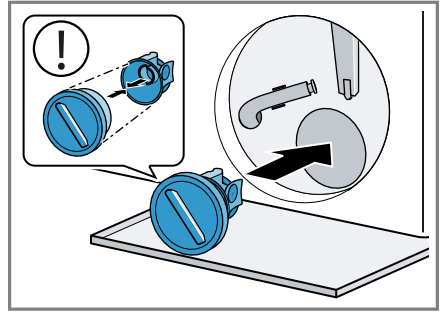

5. Screw the pump cap as far as it will go.

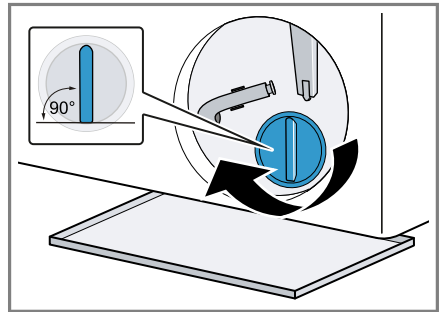

The handle on the pump cap must be in a vertical position.

6. Insert and close the maintenance flap.

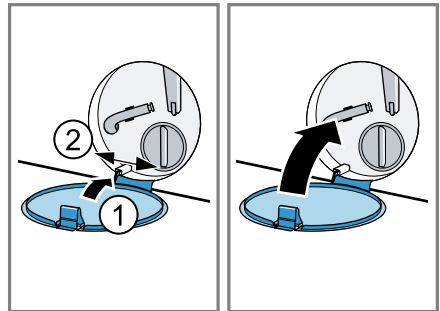

### **Before the next wash**

To prevent unused detergent from flowing straight into the outlet in the next wash, run a suitable programme for draining after you have emptied the drain pump.

1. Open the water tap.
2. Insert the mains plug.
3. Switch on the appliance.
4. Pour 1 litre of water into compartment II.
5. Select a suitable programme for draining.  
→ *"Programmes", Page 25*

# 17 Troubleshooting



You can rectify minor faults on your appliance yourself. Read the troubleshooting information before contacting after-sales service. This will avoid unnecessary costs.

**⚠ WARNING**  
**Risk of electric shock!**





Incorrect repairs are dangerous.



- ▶ Repairs to the appliance should only be carried out by trained specialist staff.
- ▶ Only use genuine spare parts when repairing the appliance.
- ▶ If the power cord of this appliance is damaged, it must be replaced by the manufacturer, the manufacturer's Customer Service or a similarly qualified person in order to prevent any risk.

Fault	Cause and troubleshooting
The display goes out and  <b>Start/Reload</b> flashes.	Energy-saving mode is active <ul style="list-style-type: none"> <li>▶ Press any button.</li> <li>✓ The display lights up again.</li> </ul>
"E:36 / -10"	Drain pump is blocked. <ul style="list-style-type: none"> <li>▶ → "<i>Cleaning the drain pump</i>", Page 35</li> </ul>
	Pump cover is not correctly assembled. <ul style="list-style-type: none"> <li>▶ Correctly assemble the pump cover.</li> </ul>
	The pump cap is not fully screwed in. <ul style="list-style-type: none"> <li>▶ Ensure that the pump cap is screwed in all the way into the appliance. The handle on the pump cap must be in a vertical position.</li> </ul>
	Drain pipe or water outlet hose is blocked. <ul style="list-style-type: none"> <li>▶ Clean the drain pipe and the water outlet hose.</li> </ul>
	Drain pipe or water drain hose is caught or jammed. <ul style="list-style-type: none"> <li>▶ Ensure that the drain pipe and water drain hose are not kinked or trapped.</li> </ul>
	The water outlet hose is connected too high. <ul style="list-style-type: none"> <li>▶ Install the water outlet hose at a maximum height of 1 metre.</li> </ul>
	Unapproved extension installed on the water drain hose. <ul style="list-style-type: none"> <li>▶ Remove any unapproved extensions from the water hose.</li> <li>→ "<i>Connecting the appliance</i>", Page 14</li> </ul>
	Detergent dosage is too high.

Fault	Cause and troubleshooting
"E:36 / -10"	<ul style="list-style-type: none"> <li>▶ Immediate measure: Mix one tablespoon of fabric softener with 0.5 litres of water and pour the mixture into compartment II (not for outdoor clothing, sportswear or items stuffed with down).</li> <li>▶ Reduce the amount of detergent for the next wash-cycle with the same load.</li> </ul>
"H:32"	<p>The unbalanced load detection system has interrupted the spin cycle because the laundry is unevenly distributed.</p> <ul style="list-style-type: none"> <li>▶ Redistribute the laundry in the drum.</li> </ul> <p><b>Note:</b> Where possible, mix large and small items in the drum. Different sized items of laundry distribute themselves better during the spin cycle.</p>
"E:30 / -10" and/or 	<p>The water pressure is low. No remedial action possible.</p> <hr/> <p>The filters in the water inflow are blocked.</p> <ul style="list-style-type: none"> <li>▶ Clean the filters in the water inflow.</li> </ul> <hr/> <p>The tap is turned off.</p> <ul style="list-style-type: none"> <li>▶ Turn on the tap.</li> </ul> <hr/> <p>The water inlet hose is kinked or jammed.</p> <ul style="list-style-type: none"> <li>▶ Ensure that the water inlet hose is not kinked or jammed.</li> </ul> <hr/> <p>Water level measurement system is defective.</p> <p><b>Note:</b> With the error message, the appliance starts a draining process.</p> <ol style="list-style-type: none"> <li>1. First wait approx. 5 minutes until the drain process ends.</li> <li>2. To reset the error message, switch the appliance off.</li> <li>3. Switch the appliance back on.</li> <li>4. If the error message is displayed again, call customer service. → <i>"Customer Service", Page 51</i></li> </ol>
 lights up.	<p>The temperature is too high.</p> <ul style="list-style-type: none"> <li>▶ Wait until the temperature has dropped.</li> <li>▶ → <i>"Cancelling the washing programme", Page 31</i></li> </ul> <hr/> <p>Water level is too high.</p> <ul style="list-style-type: none"> <li>▶ Select a suitable programme for draining. → <i>"Programmes", Page 25</i></li> </ul>









<b>Fault</b>	<b>Cause and troubleshooting</b>
<p> flashes.</p>	<p>Door is not closed.</p> <ul style="list-style-type: none"> <li>▶ Close the door.</li> </ul> <hr/> <p>Laundry is caught in the door.</p> <ul style="list-style-type: none"> <li>▶ Remove any trapped laundry.</li> </ul>
<p>"Hot" and the drum rotates.</p>	<p>Cooling process active.</p> <ol style="list-style-type: none"> <li>1. Not a fault.</li> <li>2. Do not change the programme during the cooling process.</li> </ol> <p><b>Note:</b> The cooling process takes up to 10 minutes. You can continue to operate the appliance.</p>
<p></p>	<p>Drum cleaning is required.</p> <ul style="list-style-type: none"> <li>▶ → "Cleaning the drum", Page 34</li> </ul>
<p>"H:95" lights up alternately with End.</p>	<p>The water pressure is low.</p> <ul style="list-style-type: none"> <li>▶ See → "E:30 / -10 and/or  ", Page 40</li> </ul>
<p>All other error codes.</p>	<p>Malfunction</p> <ol style="list-style-type: none"> <li>1. Switch the appliance off and then on again.</li> <li>2. If the message appears again, disconnect the appliance from the power supply for at least 30 seconds by pulling out the plug or by switching off the relevant circuit breaker in the fuse box.</li> <li>✓ If the fault was a one-off, the message disappears.</li> <li>3. If the message appears again, call the after-sales service. Please specify the exact error message when calling.</li> </ol> <p>→ "Customer Service", Page 51</p>
<p>The drying time is too long.</p>	<p>The ambient temperature is greater than 30 °C.</p> <ul style="list-style-type: none"> <li>▶ Ensure that the ambient temperature is below 30 °C.</li> </ul> <hr/> <p>Insufficient air circulation at the appliance's installation location.</p> <ul style="list-style-type: none"> <li>▶ Ventilate the appliance's installation location.</li> </ul> <hr/> <p>Fluff has accumulated in the drum.</p> <ul style="list-style-type: none"> <li>▶ Run the  <b>Drum Clean</b> programme without any laundry or detergent.</li> </ul>
<p>Creasing.</p>	<p>The load is too large.</p> <hr/> <p>The laundry lies in the drum for too long after drying.</p> <ol style="list-style-type: none"> <li>1. Remove the laundry from the drum as soon as the drying programme has finished.</li> <li>2. Spread the items of laundry for cooling.</li> </ol>

Fault	Cause and troubleshooting
Creasing.	Unsuitable programme for the type of fabric. ▶ Set the suitable programme for the type of fabric. Easy-Care fabrics are dried for too long.
The appliance is not working.	The mains plug of the power cord is not plugged in. ▶ Connect the appliance to the power supply. The circuit breaker in the fuse box has tripped. ▶ Check the circuit breaker in the fuse box. There has been a power cut. ▶ Check whether the lighting in your room or other appliances are working.
The programme does not start.	▶  <b>Start/Reload</b> has not been pressed. ▶ Press ▶  <b>Start/Reload</b> . Door is not closed. ▶ Close the door. Childproof lock is activated. ▶ Deactivate childproof lock. → "Deactivating the childproof lock", Page 32 ⏸ <b>Finish in/Time Dry</b> is activated. ▶ Check whether ⏸ <b>Finish in/Time Dry</b> is activated. → "Buttons", Page 23 Laundry is caught in the door. ▶ Remove any trapped laundry.
The door cannot be opened.	The temperature is too high. ▶ Wait until the temperature has dropped. ▶ Cancel the programme. → "Cancelling the washing programme", Page 31 Water level is too high. ▶ Select a suitable programme for draining. → "Programmes", Page 25 Power failure. ▶ Open the door using the emergency release. → "Emergency release", Page 49
The water is not draining.	Drain pipe or water outlet hose is blocked. ▶ Clean the drain pipe and the water outlet hose. Drain pipe or water drain hose is caught or jammed. ▶ Ensure that the drain pipe and water drain hose are not kinked or trapped. Drain pump is blocked.

<b>Fault</b>	<b>Cause and troubleshooting</b>
The water is not draining.	<p data-bbox="374 156 1048 188">▶ → <i>"Cleaning the drain pump", Page 35</i></p> <hr/> <p data-bbox="374 197 1048 229">The water outlet hose is connected too high.</p> <p data-bbox="374 229 1048 287">▶ Install the water outlet hose at a maximum height of 1 metre.</p> <hr/> <p data-bbox="374 296 1048 328">Pump cover is not correctly assembled.</p> <p data-bbox="374 328 1048 360">▶ Correctly assemble the pump cover.</p> <hr/> <p data-bbox="374 370 1048 402">Detergent dosage is too high.</p> <p data-bbox="374 402 1048 513">▶ Immediate measure: Mix one tablespoon of fabric softener with 0.5 litres of water and pour the mixture into compartment II (not for outdoor clothing, sportswear or items stuffed with down).</p> <p data-bbox="374 513 1048 571">▶ Reduce the amount of detergent for the next washing cycle with the same load.</p> <hr/> <p data-bbox="374 580 1048 638">Unapproved extension installed on the water drain hose.</p> <p data-bbox="374 638 1048 695">▶ Remove any unapproved extensions from the water hose.</p> <p data-bbox="374 695 1048 727">→ <i>"Connecting the appliance", Page 14</i></p> <hr/> <p data-bbox="374 737 1048 769">The pump cap is not fully screwed in.</p> <p data-bbox="374 769 1048 858">▶ Ensure that the pump cap is screwed in all the way into the appliance. The handle on the pump cap must be in a vertical position.</p>
Water is not flowing in. Detergent is not being dispensed.	<p data-bbox="374 868 1048 900">You have not pressed ▶ <b>Start/Reload.</b></p> <p data-bbox="374 900 1048 932">▶ Press ▶ <b>Start/Reload.</b></p> <hr/> <p data-bbox="374 941 1048 973">The filters in the water inflow are blocked.</p> <p data-bbox="374 973 1048 1005">▶ Clean the filters in the water inflow.</p> <hr/> <p data-bbox="374 1015 1048 1046">The tap is turned off.</p> <p data-bbox="374 1046 1048 1078">▶ Turn on the tap.</p> <hr/> <p data-bbox="374 1088 1048 1120">The water inlet hose is kinked or jammed.</p> <p data-bbox="374 1120 1048 1171">▶ Ensure that the water inlet hose is not kinked or jammed.</p>
The spin cycle runs several times.	<p data-bbox="374 1181 1048 1238">The unbalanced load detection system eliminates an imbalance by repeatedly redistributing the laundry.</p> <p data-bbox="374 1238 1048 1270">▶ Not a fault – no action required.</p> <p data-bbox="374 1279 1048 1398"><b>Note:</b> When loading, where possible, place large and small items of laundry together in the drum. Different sized items of laundry distribute themselves better during the spin cycle.</p>

Fault	Cause and troubleshooting
No water is visible in the drum.	Water is below the visible area. <ul style="list-style-type: none"> <li>▶ Not a fault – no action required.</li> <li>▶ Do not add any extra water to the appliance while it is operating.</li> </ul>
Residual water is present in the compartment ☼.	Insert in compartment ☼ is blocked. <ul style="list-style-type: none"> <li>▶ → <i>"Cleaning the detergent drawer", Page 34</i></li> </ul>
Vibrations and movement of the appliance whilst spinning.	Appliance is not correctly aligned. <ul style="list-style-type: none"> <li>▶ → <i>"Aligning the appliance", Page 15</i></li> </ul> <hr/> The appliance feet are not fixed. <ul style="list-style-type: none"> <li>▶ Secure the appliance feet. → <i>"Aligning the appliance", Page 15</i></li> </ul> <hr/> Transit bolts have not been removed. <ul style="list-style-type: none"> <li>▶ → <i>"Removing the transit bolts", Page 13.</i></li> </ul>
Drum rotates, water does not flow in.	Load detection is active. <ul style="list-style-type: none"> <li>▶ Not a fault – no action required.</li> </ul> <p><b>Note:</b> The load detection can take up to two minutes.</p>
Heavy foam build-up	Detergent dosage is too high. <ul style="list-style-type: none"> <li>▶ Immediate measure: Mix one tablespoon of fabric softener with 0.5 litres of water and pour the mixture into compartment II (not for outdoor clothing, sportswear or items stuffed with down).</li> <li>▶ Reduce the amount of detergent for the next wash-cycle with the same load.</li> </ul>
High spin speed not reached.	A low spin speed is selected. <ul style="list-style-type: none"> <li>▶ The next time you run a wash cycle, set a higher spin speed.</li> </ul> <hr/> Unbalance load detection system is using a reduced spin speed to eliminate an unbalance. <ul style="list-style-type: none"> <li>▶ Redistribute the laundry in the drum.</li> </ul> <p><b>Note:</b> Where possible, mix large and small items in the drum. Different sized items of laundry distribute themselves better during the spin cycle.</p> <ul style="list-style-type: none"> <li>▶ Start the <b>Spin</b> Ⓢ programme.</li> </ul>
The spin programme does not start.	Drain pipe or water outlet hose is blocked. <ul style="list-style-type: none"> <li>▶ Clean the drain pipe and the water outlet hose.</li> </ul> <hr/> Drain pipe or water drain hose is caught or jammed. <ul style="list-style-type: none"> <li>▶ Ensure that the drain pipe and water drain hose are not kinked or trapped.</li> </ul>

<b>Fault</b>	<b>Cause and troubleshooting</b>
The spin programme does not start.	<p>The unbalanced load detection system has interrupted the spin cycle because the laundry is unevenly distributed.</p> <ul style="list-style-type: none"> <li>▶ Redistribute the laundry in the drum.</li> </ul> <p><b>Note:</b> Where possible, mix large and small items in the drum. Different sized items of laundry distribute themselves better during the spin cycle.</p> <ul style="list-style-type: none"> <li>▶ Start the <b>Spin</b>  programme.</li> </ul>
Water is leaking out at the water inlet hose.	<p>Water inlet hose is not correctly/securely connected.</p> <ol style="list-style-type: none"> <li>1. Connect the water supply hose correctly. → <i>"Connecting the water inlet hose", Page 14</i></li> <li>2. Tighten the screw connection.</li> </ol>
Water is leaking out at the water outlet hose.	<p>The water outlet hose is damaged.</p> <ul style="list-style-type: none"> <li>▶ Replace the damaged water outlet hose.</li> </ul> <hr/> <p>Water outlet hose is not connected correctly.</p> <ul style="list-style-type: none"> <li>▶ Connect the water outlet hose correctly. → <i>"Water outlet connection types", Page 15</i></li> </ul>
The spin result is not satisfactory. The laundry is too wet/too damp.	<p>A low spin speed is selected.</p> <ul style="list-style-type: none"> <li>▶ The next time you run a wash cycle, set a higher spin speed.</li> <li>▶ Start the <b>Spin</b>  programme.</li> </ul> <hr/> <p>Drain pipe or water outlet hose is blocked.</p> <ul style="list-style-type: none"> <li>▶ Clean the drain pipe and the water outlet hose.</li> </ul> <hr/> <p>Drain pipe or water drain hose is caught or jammed.</p> <ul style="list-style-type: none"> <li>▶ Ensure that the drain pipe and water drain hose are not kinked or trapped.</li> </ul> <hr/> <p>The unbalanced load detection system has interrupted the spin cycle because the laundry is unevenly distributed.</p> <ul style="list-style-type: none"> <li>▶ Redistribute the laundry in the drum.</li> </ul> <p><b>Note:</b> Where possible, mix large and small items in the drum. Different sized items of laundry distribute themselves better during the spin cycle.</p> <ul style="list-style-type: none"> <li>▶ Start the <b>Spin</b>  programme.</li> </ul> <hr/> <p>Unbalance load detection system is using a reduced spin speed to eliminate an unbalance.</p> <ul style="list-style-type: none"> <li>▶ Redistribute the laundry in the drum.</li> </ul> <p><b>Note:</b> Where possible, mix large and small items in the drum. Different sized items of laundry distribute themselves better during the spin cycle.</p>

Fault	Cause and troubleshooting
The spin result is not satisfactory. The laundry is too wet/too damp.	▶ Start the <b>Spin</b>  programme.
Detergent residue on the damp washing.	Detergents may contain water-insoluble substances that deposit on the laundry. ▶ Start the <b>Rinse</b>  programme.
Detergent residue on the dry laundry.	Detergents may contain water-insoluble substances that deposit on the laundry. ▶ Brush out the laundry after washing and drying.
Drying programme does not start.	Door is not closed. ▶ Close the door.  No drying programme is selected. ▶ Select a suitable drying programme. → "Programmes", Page 25
The programme duration changes during the wash cycle.	The programme operation is optimised electronically. This may change the programme duration. ▶ Not a fault – no action required.  The unbalanced load detection system eliminates an imbalance by repeatedly redistributing the laundry. ▶ Not a fault – no action required.  <b>Note:</b> When loading, where possible, place large and small items of laundry together in the drum. Different sized items of laundry distribute themselves better during the spin cycle.
The programme duration changes during the wash cycle.	Foam detection system switches on a rinse cycle if foam build-up is too high. ▶ Not a fault – no action required.
Drum jerks after the programme starts.	This is caused by an internal motor test. ▶ Not a fault – no action required.
Detergent or fabric softener drips off the seal and collects on the door or in the seal fold.	Too much detergent/fabric softener in the detergent drawer. ▶ When dosing liquid detergent and fabric softener, observe the marking in the detergent drawer and do not dose above this.
Fluff on the laundry.	Fluff has accumulated in the drum. ▶ Run the  <b>Drum Clean</b> programme without any laundry or detergent.

Fault	Cause and troubleshooting
Fabric softener remains in the detergent drawer.	<p>The use of fabric softener is not supported for the selected programme.</p> <ul style="list-style-type: none"> <li>▶ Before washing, check whether the use of fabric softener is supported for the selected programme. → <i>"Programmes", Page 25</i></li> </ul>
The laundry is too damp.	<p>Unsuitable programme for the type of fabric.</p> <hr/> <p>There has been a power cut.</p> <ul style="list-style-type: none"> <li>▶ Check whether the lighting in your room or other appliances are working.</li> </ul> <hr/> <p>The load is too large.</p> <hr/> <p>After the end of the programme, warm laundry feels damper than it actually is.</p> <ol style="list-style-type: none"> <li>1. Remove the laundry from the drum as soon as the drying programme has finished.</li> <li>2. Spread the items of laundry for cooling.</li> </ol> <hr/> <p>Drying target not adjusted.</p> <hr/> <p>Load too small.</p> <hr/> <p>Water tap is closed during the drying phase.</p> <ul style="list-style-type: none"> <li>▶ Make sure that the water tap also remains open during the drying phase.</li> </ul> <hr/> <p>The ambient temperature is greater than 30 °C.</p> <ul style="list-style-type: none"> <li>▶ Ensure that the ambient temperature is below 30 °C.</li> </ul> <hr/> <p>Insufficient air circulation at the appliance's installation location.</p> <ul style="list-style-type: none"> <li>▶ Ventilate the appliance's installation location.</li> </ul> <hr/> <p>The water pressure is low. No remedial action possible.</p> <hr/> <p>Laundry is not spun sufficiently.</p> <ul style="list-style-type: none"> <li>▶ Always select the highest possible spin speed for the washing programme in question.</li> </ul> <hr/> <p>Thick and multi-layered fabrics require a longer drying time.</p> <ul style="list-style-type: none"> <li>▶ Set a timed programme for the subsequent drying. → <i>"Programmes", Page 25</i></li> </ul>
Loud noises during the spin cycle.	<p>Appliance is not correctly aligned.</p> <ul style="list-style-type: none"> <li>▶ → <i>"Aligning the appliance", Page 15</i></li> </ul> <hr/> <p>The appliance feet are not fixed.</p> <ul style="list-style-type: none"> <li>▶ Secure the appliance feet. → <i>"Aligning the appliance", Page 15</i></li> </ul>

Fault	Cause and troubleshooting
Loud noises during the spin cycle.	Transit bolts have not been removed. ▶ → <i>"Removing the transit bolts", Page 13.</i>
Banging noises, rattling in the drain pump.	Foreign bodies have got into the drain pump. ▶ → <i>"Cleaning the drain pump", Page 35</i>
Slurping, rhythmical suction noise.	The drain pump is active, the detergent solution is pumped out. ▶ Not a fault – normal operating noise.
Fan noise during the washing phase.	Process fan is active. ▶ Not a fault – normal operating noise.
Spin noise during the drying phase.	Thermal spinning is active.
Rushing, hissing noise.	Water is flushed under pressure into the detergent drawer. ▶ Not a fault – normal operating noise.
Water inlet noise during the drying phase.	Drying phase requires water. <b>1.</b> Not a fault. <b>2.</b> Make sure that the water tap also remains open during the drying phase.
Odours have formed in the appliance.	Humidity and detergent residue may promote the formation of bacteria. ▶ → <i>"Cleaning the drum", Page 34</i> ▶ If you are not using the appliance, leave the door and detergent drawer open so that residual water can evaporate.



## 17.1 Emergency release

### Releasing the door

**Requirement:** The drain pump is empty. → Page 35

1. **ATTENTION!** Escaping water may cause material damage.
- ▶ Do not open the door if you can see water through the glass.  
Pull the emergency release downwards with a tool and release.

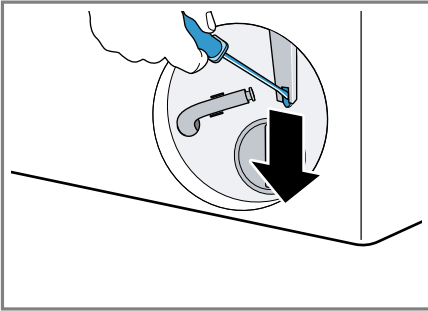

- ✓ The door lock is released.
2. Insert the maintenance flap and lock it into place.
  3. Close the maintenance flap.

---

## 18 Transportation, storage and disposal

### 18.1 Removing the appliance

1. Turn off the tap.
2. Empty the water inlet hose.
3. Switch off the appliance.  
→ "Switching off the appliance", Page 32
4. Unplug the appliance's mains plug.
5. Drain the water.  
→ "Cleaning the drain pump", Page 35
6. Detach the hoses.

### 18.2 Inserting the transit bolts

Secure the appliance before transportation using transit bolts in order to prevent transport damage.

1. Use a screwdriver to remove the 4 cover caps.

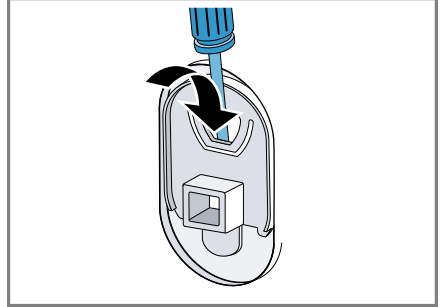

Keep the cover caps.

2. Insert the 4 transit bolts.  
→ "Removing the transit bolts", Page 13

### 18.3 Using the appliance again

- ▶ For further information, see  
→ "Installation and connection", Page 12 and  
→ "Starting an empty washing cycle", Page 19.

## 18.4 Disposing of old appliance

Valuable raw materials can be re-used by recycling.

### **WARNING**

#### **Risk of harm to health!**

Children can lock themselves in the appliance, thereby putting their lives at risk.

- ▶ Do not install the appliance behind a door as this may obstruct the appliance door or prevent it from opening.
- ▶ With redundant appliances, unplug the power cord. Then cut through the cord and damage the lock on the appliance door beyond repair so that the appliance door will no longer close.

1. Unplug the appliance from the mains.
2. Cut through the power cord.
3. Dispose of the appliance in an environmentally friendly manner.

Information about current disposal methods are available from your specialist dealer or local authority.



Dispose of packaging in an environmentally-responsible manner. This appliance is certified in accordance with the guidelines on E-waste (Management ) Rules 2022 which govern waste electrical and electronic equipment. The guideline provide a framework for the return and recycling of used appliances.

**Note:** This product doesn't contain any of hazardous substances

as specified in the e-waste Management and Handling Rules 2022.

#### Do's

- Please visit our website <https://www.siemens-home.bsh-group.in/national-e-waste-recycling-program> to find out more details regarding e-waste disposal.
- Keep the product in isolated area, after it becomes non-functional/un-repairable so as to prevent its accidental breakage.
- Consult the authorized service center as to whether the Electronic Equipment can be repaired or not, before discarding.
- Consult the retailer about appliance take back schemes.

#### Don'ts

- The product should not be opened by the user himself/herself, but only by authorized service personnel.
- The product is not meant for re-sale to any unauthorized agencies/scrap dealers/kabariwalah.
- Don't dispose of the discarded Electronic Equipment in household bins or Municipal bins.
- Don't dump the discarded Electronic Equipment in the open or in any land fill

site, as this will result in contamination of the soil and the ground water.

- Do not keep any replaced spare part(s) from the product in exposed area.

## 19 Customer Service

Detailed information on the warranty period and terms of warranty in your country is available from our after-sales service, your retailer or on our website.

If you contact Customer Service, you will require the product number (E-Nr.) and the production number (FD) of your appliance.

The contact details for Customer Service can be found in the enclosed Customer Service directory or on our website.

Helpline no.: 1800-209-1850  
(Monday to Saturday – 8 am to 8 pm)

Email ID: [service.in@siemens-home.BSH-Group.com](mailto:service.in@siemens-home.BSH-Group.com)



### 19.1 Product number (E-Nr.) and production number (FD)

You can find the product number (E-Nr.) and the production number (FD) on the appliance's rating plate.

Depending on the model, the rating plate is located:

- On the inside of the door.

- On the inside of the maintenance flap.
- On the rear of the appliance.

Make a note of your appliance's details and the Customer Service telephone number to find them again quickly.

## 20 Technical data

Appliance height	84.8 cm
Appliance width	59.8 cm
Appliance depth	59.0 cm
Appliance depth with door closed	63.5 cm
Appliance depth with door open	107.2 cm
Weight	81.3 kg
Maximum load	10.5 kg
Mains voltage	220-240 V, 50 Hz
⚡ Minimum installation protection	10 A
Nominal power	1900-2300 W
Water pressure	<ul style="list-style-type: none"> <li>■ Minimum: 30 kPa (0.3 bar)</li> <li>■ Maximum: 1000 kPa (10 bar)</li> </ul>
Length of the water inlet hose	150 cm
Length of the water outlet hose	150 cm
Length of the power cord	160 cm

EN Manufactured by BSH Hausgeräte GmbH under the trademark licence of Siemens AG

**BSH Hausgeräte GmbH**

Carl-Wery-Straße 34

81739 München, GERMANY

[siemens-home.bsh-group.in](http://siemens-home.bsh-group.in)



9001815580

(030704)

en