

# Inspiron 15 3511

## Service Manual



## Notes, cautions, and warnings

 **NOTE:** A NOTE indicates important information that helps you make better use of your product.

 **CAUTION:** A CAUTION indicates either potential damage to hardware or loss of data and tells you how to avoid the problem.

 **WARNING:** A WARNING indicates a potential for property damage, personal injury, or death.



<b>Chapter 1: Working inside your computer</b> .....	<b>7</b>
Safety instructions.....	7
Before working inside your computer.....	7
Safety precautions.....	8
Electrostatic discharge—ESD protection.....	8
ESD field service kit .....	9
Entering Service Mode.....	10
Exiting Service Mode.....	10
Transporting sensitive components.....	10
After working inside your computer.....	10
<b>Chapter 2: Removing and installing components</b> .....	<b>11</b>
Recommended tools.....	11
Screw List.....	11
Major components of Inspiron 15 3511.....	13
Secure Digital Card.....	15
Removing the Secure Digital card.....	15
Installing the Secure Digital card.....	15
Base cover.....	16
Removing the base cover.....	16
Installing the base cover.....	18
Battery.....	19
Lithium-ion battery precautions.....	19
Removing the 3-cell battery.....	20
Installing the 3-cell battery.....	21
Removing the 4-cell battery.....	21
Installing the 4-cell battery.....	22
Disconnecting the battery cable.....	23
Disconnecting the battery.....	24
Memory modules.....	25
Removing the memory module.....	25
Installing the memory module.....	26
WLAN card.....	27
Removing the WLAN card.....	27
Installing the WLAN card.....	28
Solid-state drive.....	30
Removing the M.2 2230 solid-state drive.....	30
Installing the M.2 2230 solid-state drive.....	30
Removing the M.2 2280 solid-state drive.....	31
Installing the M.2 2280 solid-state drive.....	32
Hard drive.....	33
Removing the hard drive.....	33
Installing the hard drive.....	34
System fan.....	36

Removing the system fan.....	36
Installing the system fan.....	36
Heat sink.....	37
Removing the heat sink - UMA.....	37
Installing the heat sink - UMA.....	38
Removing the heat sink - Discrete.....	39
Installing the heat sink - Discrete.....	40
Speakers.....	41
Removing the speakers.....	41
Installing the speakers.....	42
IO board.....	43
Removing the I/O board.....	43
Installing the I/O board.....	44
Touchpad.....	45
Removing the touchpad assembly.....	45
Installing the touch pad assembly.....	46
Display assembly.....	48
Removing the display assembly.....	48
Installing the display assembly.....	50
Hinge caps.....	52
Removing the hinge caps.....	52
Installing the hinge caps .....	53
Display bezel.....	55
Removing the display bezel.....	55
Installing the display bezel .....	56
Hinges.....	57
Removing the hinges.....	57
Installing the hinges .....	59
Display panel.....	60
Removing the display panel.....	60
Installation display panel.....	62
Camera.....	64
Removing the camera.....	64
Installing the camera.....	65
Display eDP cable.....	65
Removing the eDP cable.....	65
Installing the eDP cable.....	66
Display back-cover.....	68
Removing the display back-cover.....	68
Installing the display back-cover.....	68
Power button.....	69
Removing the power button.....	69
Installing the power button.....	70
Power button with fingerprint reader.....	71
Removing the power-button with fingerprint reader.....	71
Installing the power-button with fingerprint reader.....	72
System board.....	74
System board connectors.....	74
Removing the system board.....	74
Installing the system board.....	76

Power-adaptor port.....	78
Removing the power-adaptor port.....	78
Installing the power-adaptor port.....	79
Palm-rest and keyboard assembly.....	80
Removing the palm-rest and keyboard assembly.....	80
Installing the palm-rest and keyboard assembly.....	81
<b>Chapter 3: Drivers and downloads.....</b>	<b>82</b>
<b>Chapter 4: System setup.....</b>	<b>83</b>
Entering BIOS setup program.....	83
Navigation keys.....	83
BIOS overview.....	83
One time boot menu.....	84
Boot Sequence.....	84
System setup options.....	84
Boot menu.....	84
Overview.....	85
Boot Configuration.....	87
Integrated Devices.....	87
Storage.....	88
Display.....	89
Connection.....	89
Security.....	90
Passwords.....	90
Update Recovery.....	90
System Management.....	91
Keyboard.....	91
Pre-boot Behavior.....	92
System Logs.....	92
Updating the BIOS.....	93
Updating the BIOS in Windows.....	93
Updating the BIOS using the USB drive in Windows.....	93
Flashing the BIOS from the F12 One-Time boot menu.....	94
Updating BIOS on systems with BitLocker enabled.....	94
System and setup password.....	94
Assigning a system setup password.....	95
Deleting or changing an existing system setup password.....	95
Clearing BIOS (System Setup) and System passwords.....	96
<b>Chapter 5: Troubleshooting.....</b>	<b>97</b>
Handling swollen Lithium-ion batteries.....	97
Dell SupportAssist Pre-boot System Performance Check diagnostics.....	97
Running the SupportAssist Pre-Boot System Performance Check.....	98
Built-in self-test (BIST).....	98
M-BIST.....	98
LCD Power rail test (L-BIST).....	99
LCD Built-in Self Test (BIST).....	99
System diagnostic lights.....	99











Recovering the operating system..... 101  
Real Time Clock—RTC reset.....101  
Backup media and recovery options..... 101  
WiFi power cycle.....102  
Drain residual flea power (perform hard reset).....102

**Chapter 6: Getting help and contacting Dell.....103**

# Working inside your computer



## Safety instructions

Use the following safety guidelines to protect your computer from potential damage and to ensure your personal safety. Unless otherwise noted, each procedure included in this document assumes that you have read the safety information that shipped with your computer.

-  **WARNING:** Before working inside your computer, read the safety information that is shipped with your computer. For more safety best practices, see the Regulatory Compliance home page at [www.dell.com/regulatory\\_compliance](http://www.dell.com/regulatory_compliance).
-  **WARNING:** Disconnect your computer from all power sources before opening the computer cover or panels. After you finish working inside the computer, replace all covers, panels, and screws before connecting your computer to an electrical outlet.
-  **CAUTION:** To avoid damaging the computer, ensure that the work surface is flat, dry, and clean.
-  **CAUTION:** To avoid damaging the components and cards, handle them by their edges, and avoid touching the pins and the contacts.
-  **CAUTION:** You should only perform troubleshooting and repairs as authorized or directed by the Dell technical assistance team. Damage due to servicing that is not authorized by Dell is not covered by your warranty. See the safety instructions that is shipped with the product or at [www.dell.com/regulatory\\_compliance](http://www.dell.com/regulatory_compliance).
-  **CAUTION:** Before touching anything inside your computer, ground yourself by touching an unpainted metal surface, such as the metal at the back of the computer. While you work, periodically touch an unpainted metal surface to dissipate static electricity which could harm internal components.
-  **CAUTION:** When you disconnect a cable, pull it by its connector or its pull tab, not the cable itself. Some cables have connectors with locking tabs or thumbscrews that you must disengage before disconnecting the cable. When disconnecting cables, keep them evenly aligned to avoid bending the connector pins. When connecting cables, ensure that the ports and the connectors are correctly oriented and aligned.
-  **CAUTION:** Press and eject any installed card from the media-card reader.
-  **CAUTION:** Exercise caution when handling Lithium-ion batteries in laptops. Swollen batteries should not be used and should be replaced and disposed properly.
-  **NOTE:** The color of your computer and certain components may appear differently than shown in this document.

## Before working inside your computer

### Steps

1. Save and close all open files and exit all open applications.
2. Shut down your computer. Click **Start** >  **Power** > **Shut down**.
  -  **NOTE:** If you are using a different operating system, see the documentation of your operating system for shut-down instructions.
3. Disconnect your computer and all attached devices from their electrical outlets.
4. Disconnect all attached network devices and peripherals, such as keyboard, mouse, and monitor from your computer.

5. Remove any media card and optical disc from your computer, if applicable.
6. After the computer is unplugged, press and hold the power button for 5 seconds to ground the system board.

 **CAUTION: Place the computer on a flat, soft, and clean surface to avoid scratches on the display.**

7. Place the computer face down.

## Safety precautions

The safety precautions chapter details the primary steps to be taken before performing any disassembly instructions.

Observe the following safety precautions before you perform any installation or break/fix procedures involving disassembly or reassembly:

- Turn off the system and all attached peripherals.
- Disconnect the system and all attached peripherals from AC power.
- Disconnect all network cables, telephone, and telecommunications lines from the system.
- Use an ESD field service kit when working inside any to avoid electrostatic discharge (ESD) damage.
- After removing any system component, carefully place the removed component on an anti-static mat.
- Wear shoes with non-conductive rubber soles to reduce the chance of getting electrocuted.

## Standby power

Dell products with standby power must be unplugged before you open the case. Systems that incorporate standby power are essentially powered while turned off. The internal power enables the system to be remotely turned on (wake on LAN) and suspended into a sleep mode and has other advanced power management features.

Unplugging, pressing and holding the power button for 20 seconds should discharge residual power in the system board.

## Bonding

Bonding is a method for connecting two or more grounding conductors to the same electrical potential. This is done through the use of a field service electrostatic discharge (ESD) kit. When connecting a bonding wire, ensure that it is connected to bare metal and never to a painted or non-metal surface. The wrist strap should be secure and in full contact with your skin, and ensure that you remove all jewelry such as watches, bracelets, or rings prior to bonding yourself and the equipment.

## Electrostatic discharge—ESD protection

ESD is a major concern when you handle electronic components, especially sensitive components such as expansion cards, processors, memory DIMMs, and system boards. Very slight charges can damage circuits in ways that may not be obvious, such as intermittent problems or a shortened product life span. As the industry pushes for lower power requirements and increased density, ESD protection is an increasing concern.

Due to the increased density of semiconductors used in recent Dell products, the sensitivity to static damage is now higher than in previous Dell products. For this reason, some previously approved methods of handling parts are no longer applicable.

Two recognized types of ESD damage are catastrophic and intermittent failures.

- **Catastrophic** – Catastrophic failures represent approximately 20 percent of ESD-related failures. The damage causes an immediate and complete loss of device functionality. An example of catastrophic failure is a memory DIMM that has received a static shock and immediately generates a "No POST/No Video" symptom with a beep code emitted for missing or nonfunctional memory.
- **Intermittent** – Intermittent failures represent approximately 80 percent of ESD-related failures. The high rate of intermittent failures means that most of the time when damage occurs, it is not immediately recognizable. The DIMM receives a static shock, but the tracing is merely weakened and does not immediately produce outward symptoms related to the damage. The weakened trace may take weeks or months to melt, and in the meantime may cause degradation of memory integrity, intermittent memory errors, etc.

The more difficult type of damage to recognize and troubleshoot is the intermittent (also called latent or "walking wounded") failure.

Perform the following steps to prevent ESD damage:

- Use a wired ESD wrist strap that is properly grounded. The use of wireless anti-static straps is no longer allowed; they do not provide adequate protection. Touching the chassis before handling parts does not ensure adequate ESD protection on parts with increased sensitivity to ESD damage.
- Handle all static-sensitive components in a static-safe area. If possible, use anti-static floor pads and workbench pads.
- When unpacking a static-sensitive component from its shipping carton, do not remove the component from the anti-static packing material until you are ready to install the component. Before unwrapping the anti-static packaging, ensure that you discharge static electricity from your body.
- Before transporting a static-sensitive component, place it in an anti-static container or packaging.

## ESD field service kit

The unmonitored Field Service kit is the most commonly used service kit. Each Field Service kit includes three main components: anti-static mat, wrist strap, and bonding wire.

### Components of an ESD field service kit

The components of an ESD field service kit are:

- **Anti-Static Mat** – The anti-static mat is dissipative and parts can be placed on it during service procedures. When using an anti-static mat, your wrist strap should be snug and the bonding wire should be connected to the mat and to any bare metal on the system being worked on. Once deployed properly, service parts can be removed from the ESD bag and placed directly on the mat. ESD-sensitive items are safe in your hand, on the ESD mat, in the system, or inside a bag.
- **Wrist Strap and Bonding Wire** – The wrist strap and bonding wire can be either directly connected between your wrist and bare metal on the hardware if the ESD mat is not required, or connected to the anti-static mat to protect hardware that is temporarily placed on the mat. The physical connection of the wrist strap and bonding wire between your skin, the ESD mat, and the hardware is known as bonding. Use only Field Service kits with a wrist strap, mat, and bonding wire. Never use wireless wrist straps. Always be aware that the internal wires of a wrist strap are prone to damage from normal wear and tear, and must be checked regularly with a wrist strap tester in order to avoid accidental ESD hardware damage. It is recommended to test the wrist strap and bonding wire at least once per week.
- **ESD Wrist Strap Tester** – The wires inside of an ESD strap are prone to damage over time. When using an unmonitored kit, it is a best practice to regularly test the strap prior to each service call, and at a minimum, test once per week. A wrist strap tester is the best method for doing this test. If you do not have your own wrist strap tester, check with your regional office to find out if they have one. To perform the test, plug the wrist-strap's bonding-wire into the tester while it is strapped to your wrist and push the button to test. A green LED is lit if the test is successful; a red LED is lit and an alarm sounds if the test fails.
- **Insulator Elements** – It is critical to keep ESD sensitive devices, such as plastic heat sink casings, away from internal parts that are insulators and often highly charged.
- **Working Environment** – Before deploying the ESD Field Service kit, assess the situation at the customer location. For example, deploying the kit for a server environment is different than for a desktop or portable environment. Servers are typically installed in a rack within a data center; desktops or portables are typically placed on office desks or cubicles. Always look for a large open flat work area that is free of clutter and large enough to deploy the ESD kit with additional space to accommodate the type of system that is being repaired. The workspace should also be free of insulators that can cause an ESD event. On the work area, insulators such as Styrofoam and other plastics should always be moved at least 12 inches or 30 centimeters away from sensitive parts before physically handling any hardware components
- **ESD Packaging** – All ESD-sensitive devices must be shipped and received in static-safe packaging. Metal, static-shielded bags are preferred. However, you should always return the damaged part using the same ESD bag and packaging that the new part arrived in. The ESD bag should be folded over and taped shut and all the same foam packing material should be used in the original box that the new part arrived in. ESD-sensitive devices should be removed from packaging only at an ESD-protected work surface, and parts should never be placed on top of the ESD bag because only the inside of the bag is shielded. Always place parts in your hand, on the ESD mat, in the system, or inside an anti-static bag.
- **Transporting Sensitive Components** – When transporting ESD sensitive components such as replacement parts or parts to be returned to Dell, it is critical to place these parts in anti-static bags for safe transport.

### ESD protection summary

It is recommended that all field service technicians use the traditional wired ESD grounding wrist strap and protective anti-static mat at all times when servicing Dell products. In addition, it is critical that technicians keep sensitive parts separate from all insulator parts while performing service and that they use anti-static bags for transporting sensitive components.

## Entering Service Mode

**Service Mode** allows users to immediately cut off electricity from the computer and conduct repairs without disconnecting the battery cable from the system board.

To enter **Service Mode**:

1. Shut down your computer and disconnect the AC adapter.
2. Hold **<B>** key on the keyboard and press the power button for 3 seconds or until the Dell logo appears on the screen.
3. Press any key to continue.

 **NOTE:** If the power adapter has not been disconnected, a message prompting you to remove the AC adapter appears on the screen. Remove the AC adapter and then press any key to continue the **Service Mode** procedure.

 **NOTE:** The **Service Mode** procedure automatically skips the following step if the **Owner Tag** of the computer is not set up in advance by the manufacturer.

4. When the ready-to-proceed message appears on the screen, press any key to proceed. The computer emits three short beeps and shuts down immediately.

Once the computer shuts down, you may perform the replacement procedures without disconnecting the battery cable from the system board.

## Exiting Service Mode

**Service Mode** allows users to immediately cut off electricity from the computer and conduct repairs without disconnecting the battery cable from the system board.

To exit **Service Mode**:

1. Connect the AC adapter to the power-adaptor port on your computer.
2. Press the power button to turn on the computer. Your computer will automatically return to normal functioning mode.

## Transporting sensitive components

When transporting ESD sensitive components such as replacement parts or parts to be returned to Dell, it is critical to place these parts in anti-static bags for safe transport.

## After working inside your computer

### About this task

 **NOTE:** Leaving stray or loose screws inside your computer may severely damage your computer.

### Steps

1. Replace all screws and ensure that no stray screws remain inside your computer.
2. Connect any external devices, peripherals, or cables you removed before working on your computer.
3. Replace any media cards, discs, or any other parts that you removed before working on your computer.
4. Connect your computer and all attached devices to their electrical outlets.
5. Turn on your computer.



# Removing and installing components

**NOTE:** The images in this document may differ from your computer depending on the configuration you ordered.

## Recommended tools







The procedures in this document may require the following tools:

- Phillips #0 screwdriver
- Phillips #1 screwdriver
- Plastic scribe-Recommended for field technician

## Screw List

The following table shows the screw list and the images for different components.

**Table 1. Screw Size List**

Component	Screw type	Quantity	Image
Base cover	M2x5	6	
	Captive screw	2	
Battery 3-cell	M2x3	3	
Battery 4-cell	M2x3	4	
WLAN	M2x3	1	
M.2 2230 SSD	M2x2	1	
M.2 2280 SSD	M2x2	1	

**Table 1. Screw Size List (continued)**

Component	Screw type	Quantity	Image
Hard drive	M2x3	4	
Hard Drive Bracket	M3x3	4	
Touchpad	M2x2	2	
Touchpad bracket	M2x2	3	
System fan	M2x5	2	
Heatsink - Integrated graphics	M2x3	4	
Heatsink - Discrete graphics	M2x3	7	
System board	M2.5x5 M2x3 M2x2	2 3 1	
Power button	M2x2 M2.5x5	2	

**Table 1. Screw Size List (continued)**

Component	Screw type	Quantity	Image
			
I/O board	M2x3	3	
Display assembly	M2.5x5	4	
Display hinge	M2.5x3.8	6	

## Major components of Inspiron 15 3511

The following image shows the major components of Inspiron 15 3511.

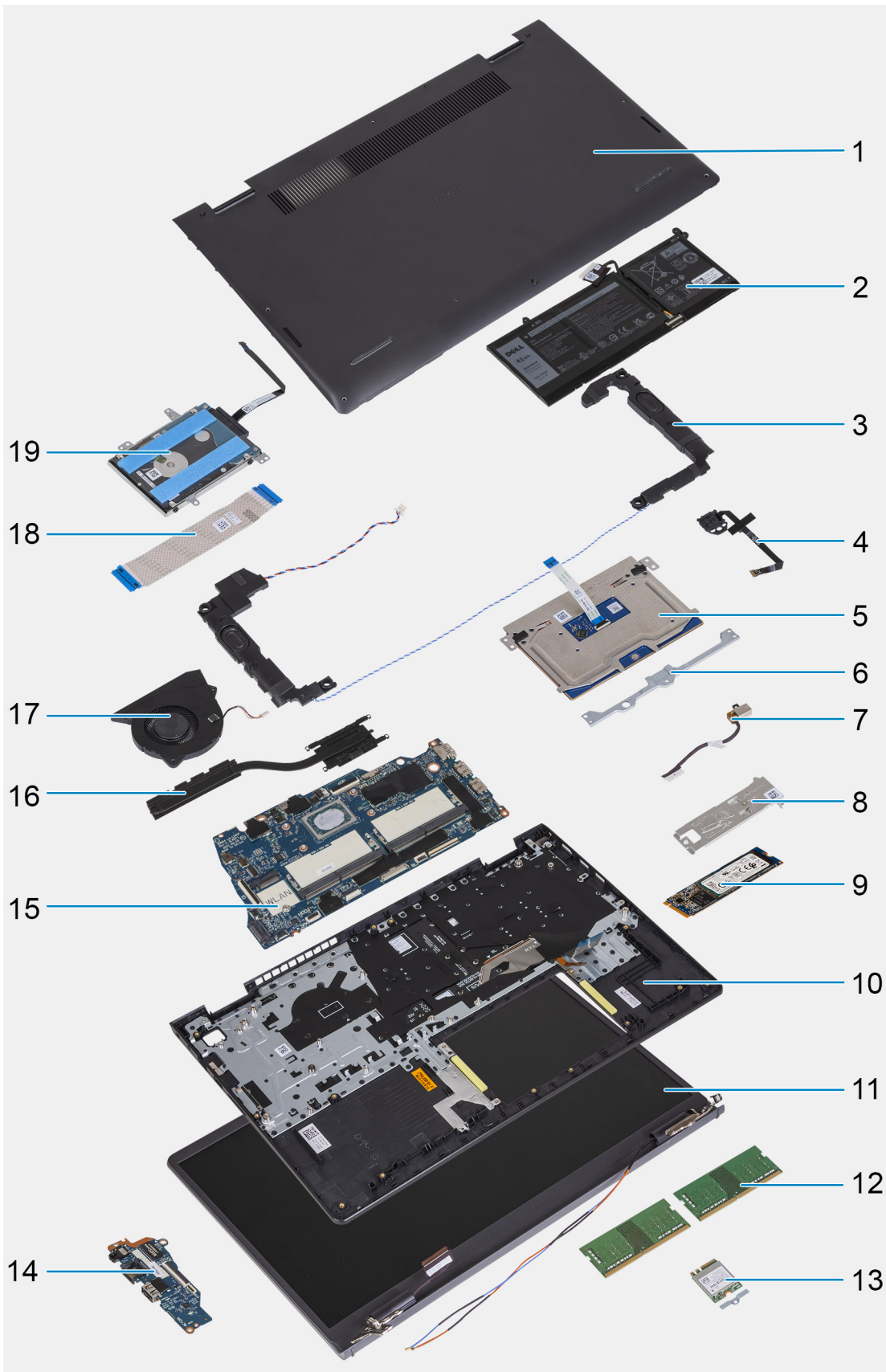

1. Base cover
2. Battery
3. Speaker
4. Power button with optional fingerprint reader

- 5. Trackpad
- 6. Trackpad bracket
- 7. DC-in port
- 8. SSD thermal bracket
- 9. Solid-state drive(SSD)
- 10. Palm-rest and keyboard assembly
- 11. Display assembly
- 12. Memory modules
- 13. WLAN card
- 14. IO daughter-board
- 15. System board
- 16. Heatsink
- 17. System fan
- 18. IO daughter-board FFC
- 19. Hard-drive assembly

## Secure Digital Card

### Removing the Secure Digital card

#### Prerequisites

- 1. Follow the procedure in [Before working inside your computer.](#)

#### About this task

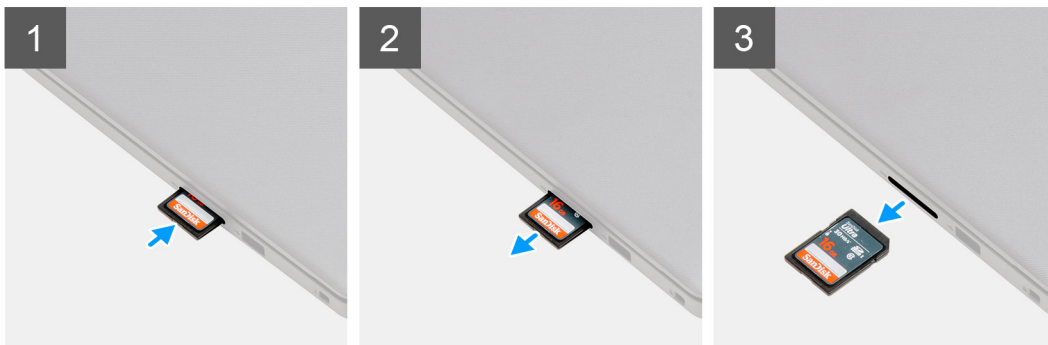

#### Steps

- 1. Push the secure digital card to release it from the computer.
- 2. Slide the secure digital card out of the computer.

### Installing the Secure Digital card

#### Prerequisites

If you are replacing a component, remove the existing component before performing the installation procedure.

## About this task

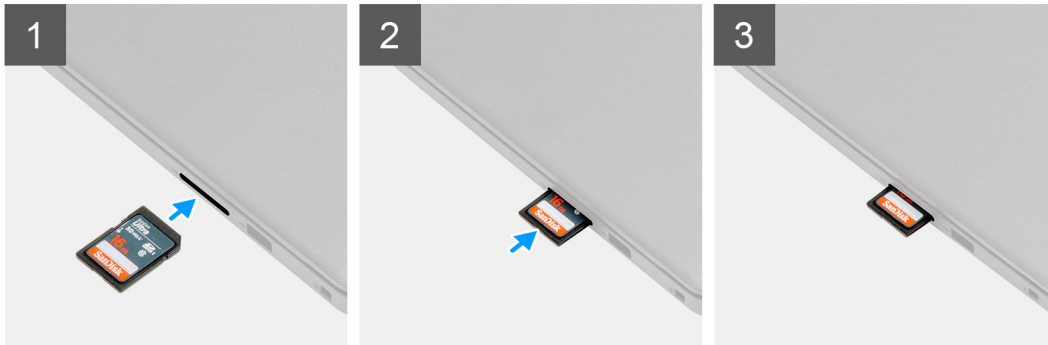

### Steps

Slide the secure digital into the slot until it clicks into place.

### Next steps

1. Follow the procedure in [after working inside your computer](#).

## Base cover

### Removing the base cover

#### Prerequisites

1. Follow the procedure in [before working inside your computer](#).
2. Remove the [SD card](#).
3. Enter [service mode](#).

### About this task

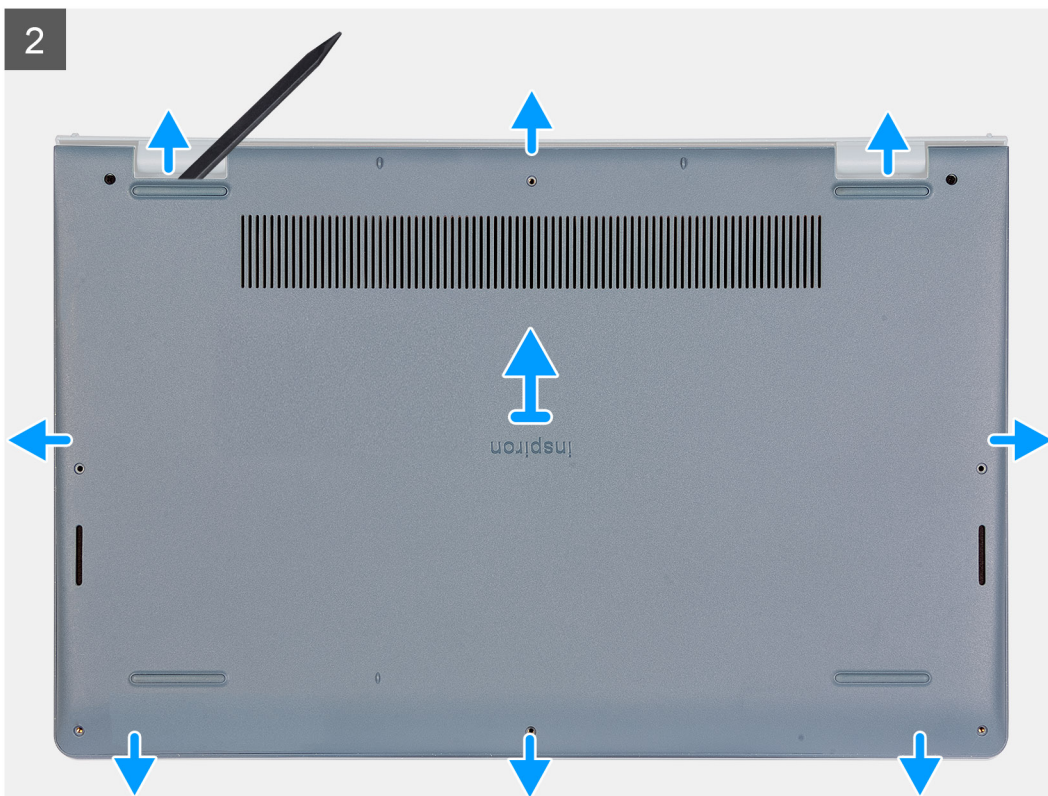
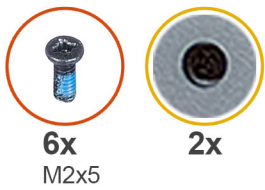



### Steps

1. Remove the six screws (M2x5) that secure the base cover to the palm-rest and keyboard assembly.
2. Loosen the two captive screws that secure the base cover to the palm-rest and keyboard assembly.
3. Pry open the base cover starting from the recesses located in the U-shaped indents at the top edge of the base cover near the hinges.



4. Lift and slide the base cover off the palm-rest and keyboard assembly.

## Installing the base cover

### Prerequisites

If you are replacing a component, remove the existing component before performing the installation procedure.



## About this task

3



### Steps

1. Align and place the base cover on the computer, press the edges and sides of the base cover until it snaps into place.
2. Tighten the two captive screws that secure the base cover to the palm-rest and keyboard assembly.
3. Replace the six screws (M2x5) that secure the base cover to the palm-rest and keyboard assembly.

### Next steps

1. Exit [service mode](#).
2. Replace the [SD card](#)
3. Follow the procedure in [after working inside your computer](#)

## Battery

### Lithium-ion battery precautions

#### ⚠ CAUTION:

- Exercise caution when handling Lithium-ion batteries.
- Discharge the battery completely before removing it. Disconnect the AC power adapter from the system and operate the computer solely on battery power—the battery is fully discharged when the computer no longer turns on when the power button is pressed.
- Do not crush, drop, mutilate, or penetrate the battery with foreign objects.
- Do not expose the battery to high temperatures, or disassemble battery packs and cells.
- Do not apply pressure to the surface of the battery.
- Do not bend the battery.
- Do not use tools of any kind to pry on or against the battery.
- Ensure any screws during the servicing of this product are not lost or misplaced, to prevent accidental puncture or damage to the battery and other system components.

- If the battery gets stuck inside your computer as a result of swelling, do not try to release it as puncturing, bending, or crushing a lithium-ion battery can be dangerous. In such an instance, contact Dell technical support for assistance. See [www.dell.com/contactdell](http://www.dell.com/contactdell).
- Always purchase genuine batteries from [www.dell.com](http://www.dell.com) or authorized Dell partners and resellers.
- Swollen batteries should not be used and should be replaced and disposed properly. For guidelines on how to handle and replace swollen Lithium-ion batteries, see [Handling swollen Lithium-ion batteries](#).

## Removing the 3-cell battery

### Prerequisites

1. Follow the procedure in [before working inside your computer](#).
2. Remove the [SD card](#).
3. Remove the [base cover](#).

### About this task

The following image indicate the location of the battery and provides a visual representation of the removal procedure.

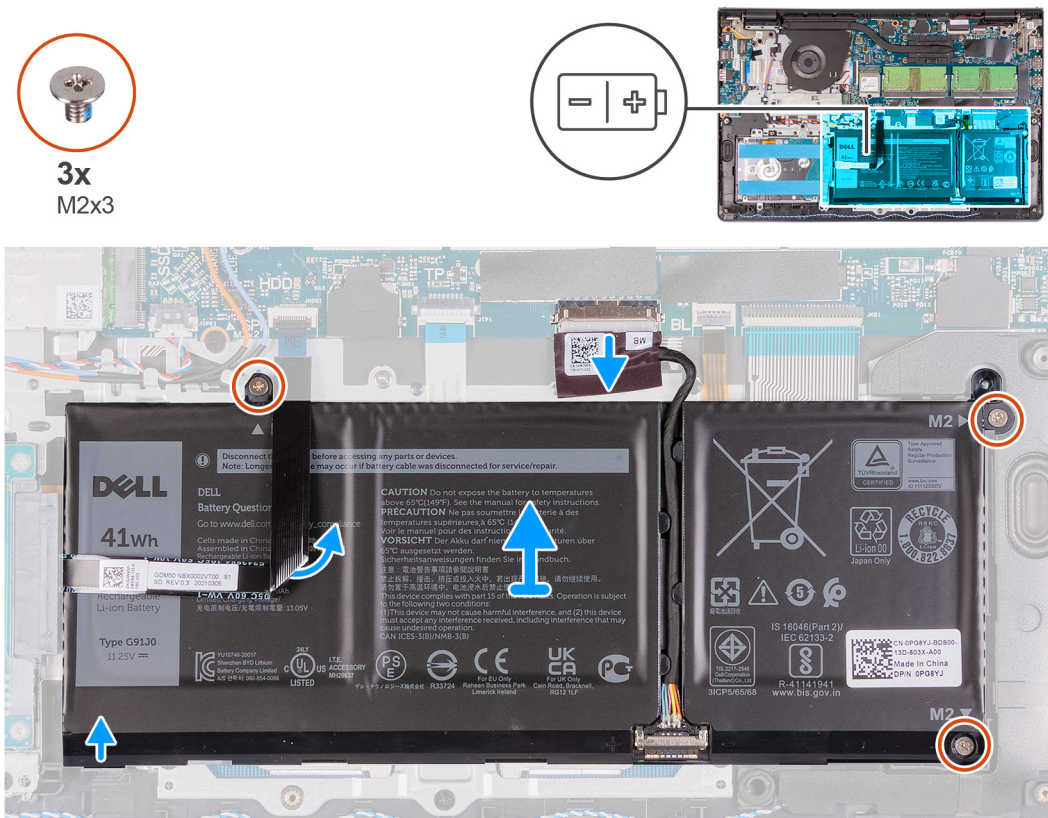

### Steps

1. Disconnect the battery cable from the connector on the system board.
2. Fold back the hard-drive FFC from over the battery.
3. Remove the three (M2x3) screws that secure the battery to the palm-rest and keyboard assembly.
4. Lift and move the battery away from the computer.

# Installing the 3-cell battery

## Prerequisites

If you are replacing a component, remove the existing component before performing the installation process.

## About this task

The following images indicate the location of the battery and provides a visual representation of the installation procedure.

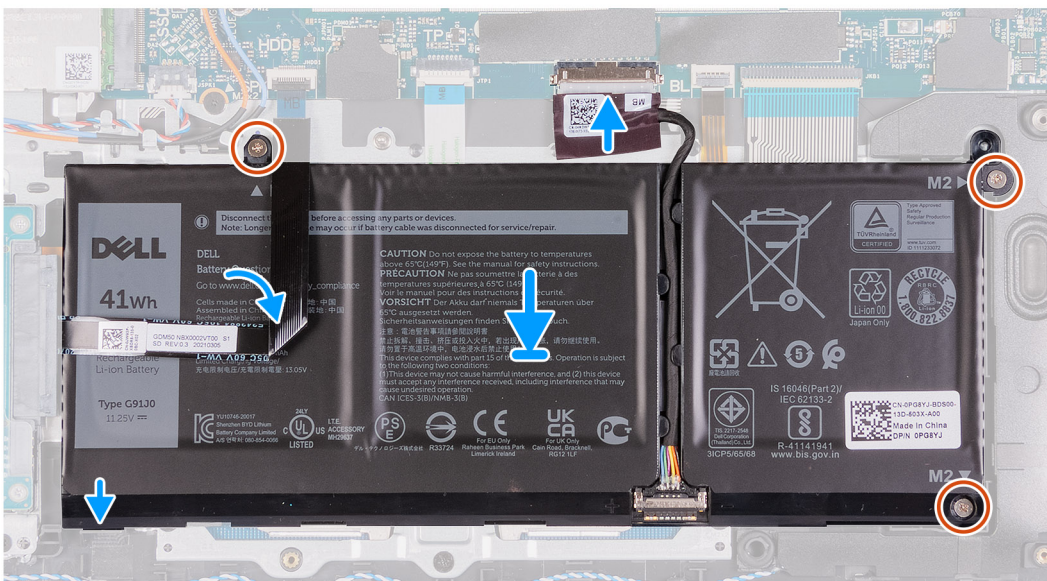
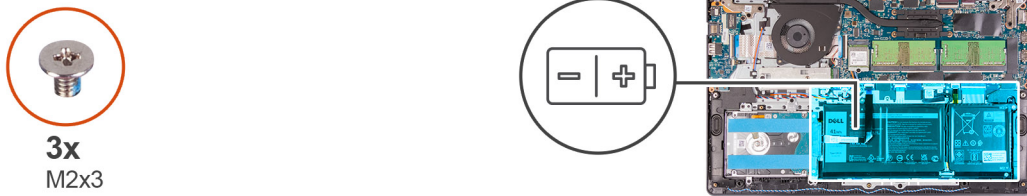

## Steps

1. Place the battery on the palm-rest and keyboard assembly.
2. Fold back the hard-drive FFC over the battery.
3. Align the screw holes on the battery to the screw holes on the palm-rest and keyboard assembly.
4. Replace the three screws (M2x3) that secure the battery to the palm-rest and keyboard assembly.
5. Connect the battery cable to the connector on the system board.

## Next steps

1. Install the [base cover](#).
2. Install the [SD card](#).
3. Follow the procedure in [after working inside your computer](#).

# Removing the 4-cell battery

## Prerequisites

1. Follow the procedure in [before working inside your computer](#).
2. Remove the [SD card](#).
3. Remove the [base cover](#).



### About this task

The following images indicate the location of the battery and provides a visual representation of the installation procedure.

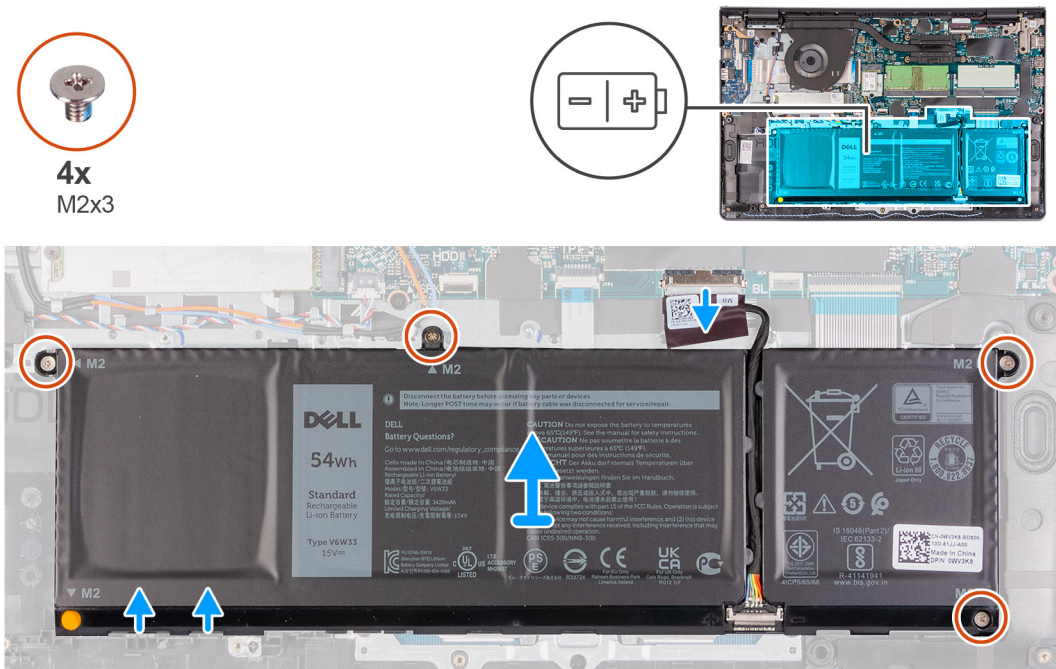

### Steps

1. Disconnect the battery cable from the connector on the system board.
2. Remove the four (M2x3) screws that secure the battery to the palmrest.
3. Lift and move the battery away from the computer.

## Installing the 4-cell battery

### Prerequisites

If you are replacing a component, remove the existing component before performing the installation process.

### About this task

The following images indicate the location of the battery and provides a visual representation of the installation procedure.



4x  
M2x3

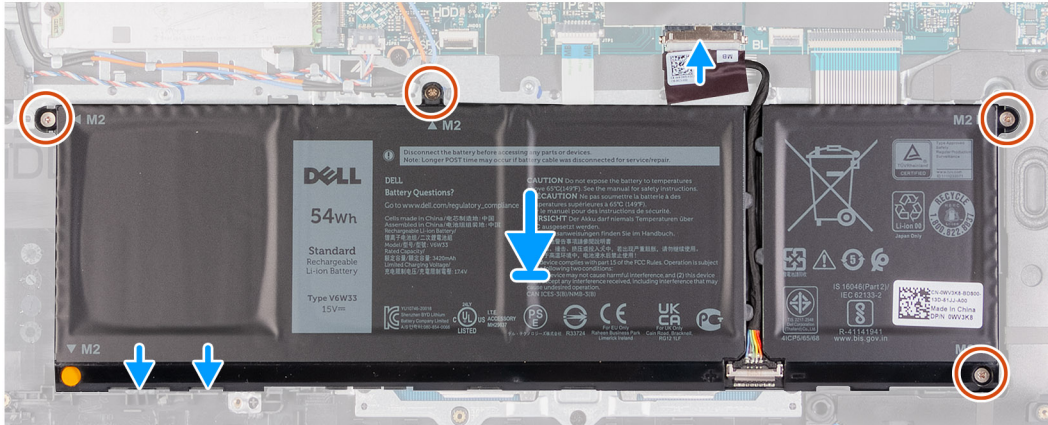
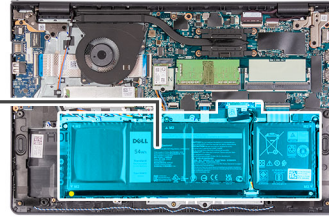
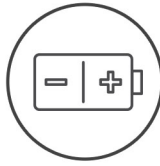

### Steps

1. Place the battery on the palm-rest and keyboard assembly.
2. Align the screw holes on the battery to the screw holes on the palmrest and keyboard assembly.
3. Replace the three screws (M2x3) that secure the battery to the palmrest and keyboard assembly.
4. Connect the battery cable to the connector on the system board.

### Next steps

1. Install the [base cover](#).
2. Install the [SD card](#).
3. Follow the procedure in [after working inside your computer](#).

## Disconnecting the battery cable

### Prerequisites

1. Follow the procedure in [before working inside your computer](#).
2. Remove the [SD card](#).
3. Remove the [base cover](#).

## About this task

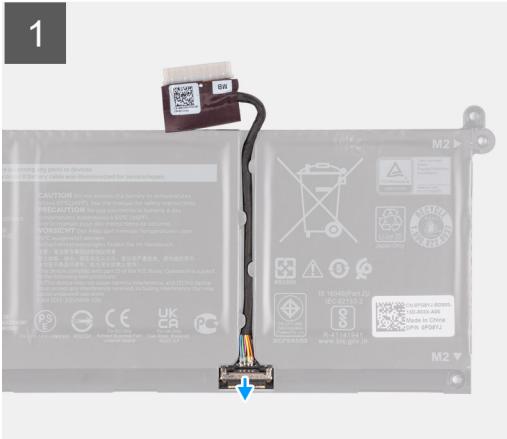

## Steps

1. Lift the latch on the battery cable.
2. Disconnect the battery cable from the connector on the battery.

## Disconnecting the battery

### Prerequisites

1. Follow the procedure in [before working inside your computer](#).
2. Remove the [SD card](#).
3. Remove the [base cover](#).

## About this task

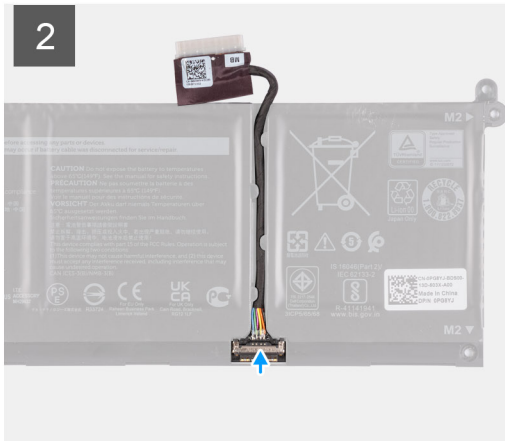

## Steps

1. Connect the battery cable to the connector on the battery.
2. Close the latch on the battery cable connector to secure it to the battery.

# Memory modules

## Removing the memory module

### Prerequisites

1. Follow the procedure in [before working inside your computer](#).
2. Remove the [SD card](#).
3. Enter [service mode](#).
4. Remove the [base cover](#).

## About this task

The following images indicate the location of the memory module and provides a visual representation of the removal procedure.

 **NOTE:** Depending on the configuration ordered your computer may come shipped with one or two memory module installed.

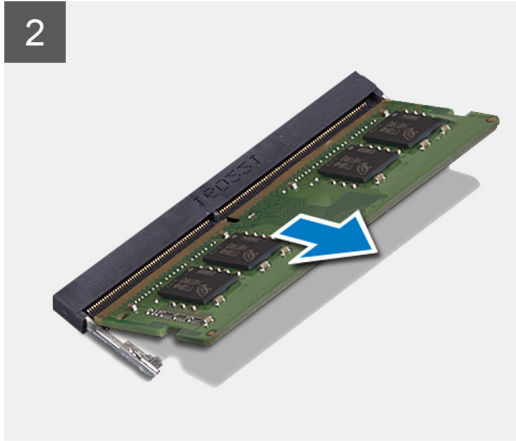
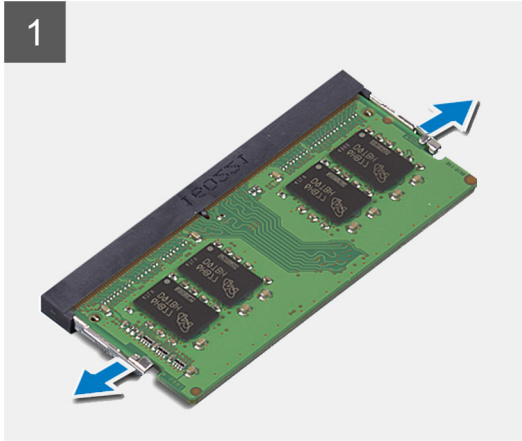
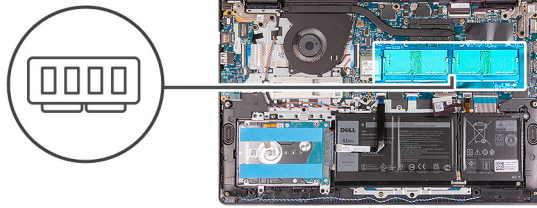

### Steps

1. Use your fingertips to carefully spread apart the securing-clips on each end of the memory-module slot until the memory module pops up.
2. Lift at an angle and remove the memory module from its slot on the system board.
3. Repeat the procedure above for the second memory module, if applicable.

## Installing the memory module

### Prerequisites

If you are replacing a component, remove the existing component before performing the installation procedure.

### About this task

The following images indicate the location of the memory module and provides a visual representation of the installation procedure.



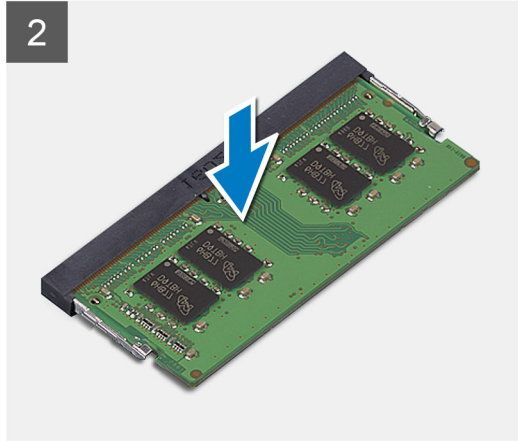
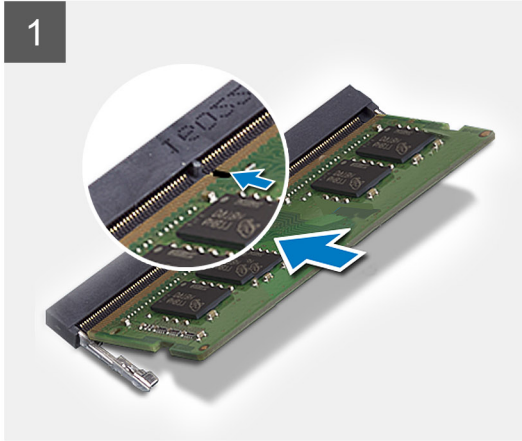
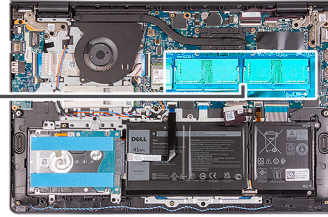
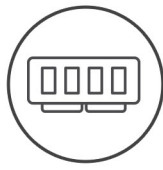

## Steps

1. Align the notch on the memory module with the tab on the memory module slot and slide the memory module firmly into the slot at an angle.
2. Press down on the memory module to snap it into place.  
**i** **NOTE:** If you do not hear the click, remove the memory module and reinstall it.
3. Ensure that the securing clips have locked the memory module into place.  
**i** **NOTE:** If the securing clips are not locking the memory module into place remove the memory module from the slot and repeat steps 1 and 2.
4. Repeat the procedure above for the second memory module, if applicable.

## Next steps

1. Install the [base cover](#).
2. Exit [service mode](#).
3. Install the [SD card](#).
4. Follow the procedure in [after working inside your computer](#).

# WLAN card

## Removing the WLAN card

### Prerequisites

1. Follow the procedure in [before working inside your computer](#).
2. Remove the [SD card](#).
3. Enter [service mode](#).
4. Remove the [base cover](#).

### About this task

The following images indicate the location of the wireless card and provides a visual representation of the removal procedure.



1x  
M2x3

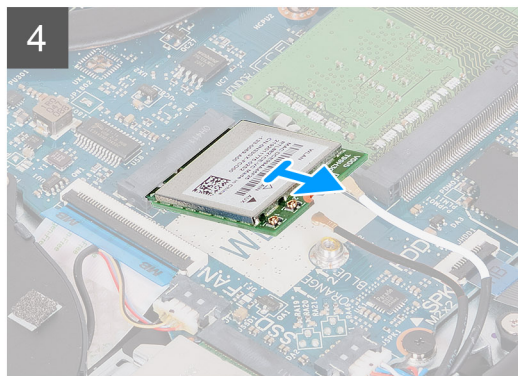
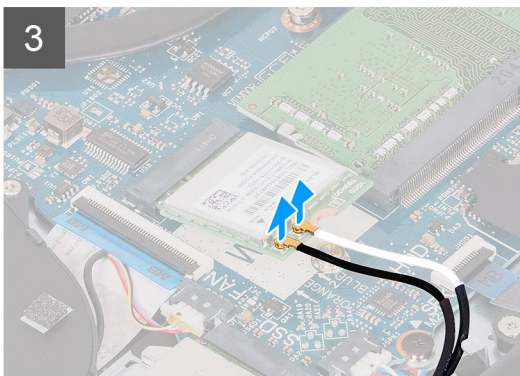
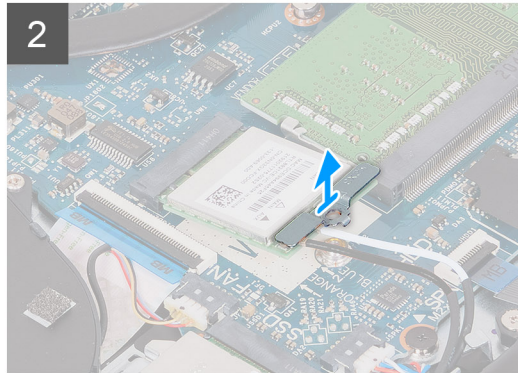
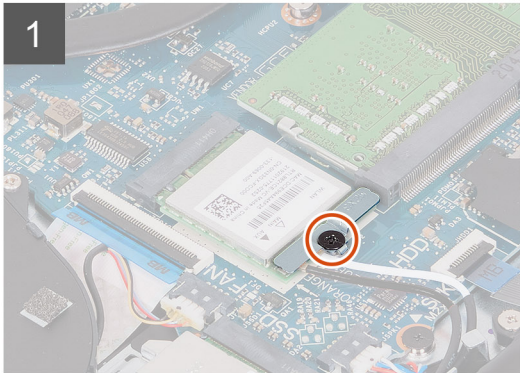
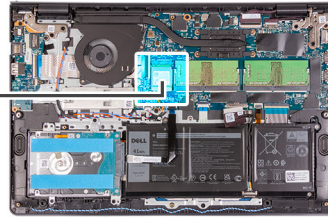

### Steps

1. Remove the single (M2x3) screw that secures the WLAN-card bracket to the system board.
2. Slide and remove the WLAN-card bracket that secures the WLAN-antenna cables.
3. Disconnect the WLAN-antenna cables from the connectors on the WLAN card.
4. Slide and remove the wireless card from the M.2 card slot on the system board.

## Installing the WLAN card

### Prerequisites

If you are replacing a component, remove the existing component before performing the installation procedure.

### About this task

The following images indicate the location of the wireless card and provides a visual representation of the installation procedure.



1x  
M2x3

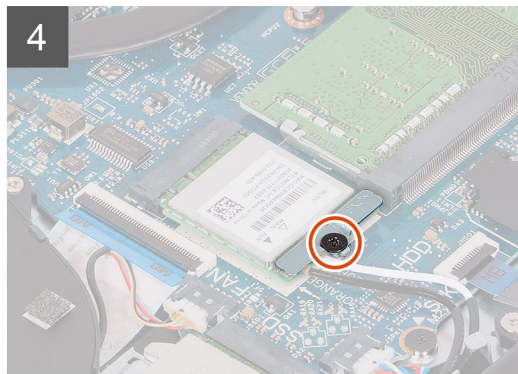
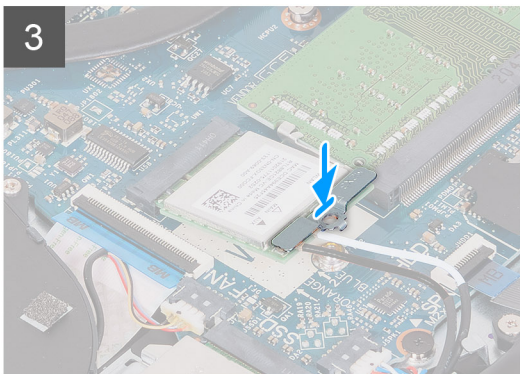
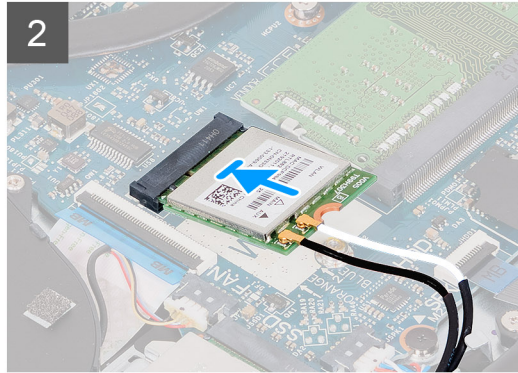
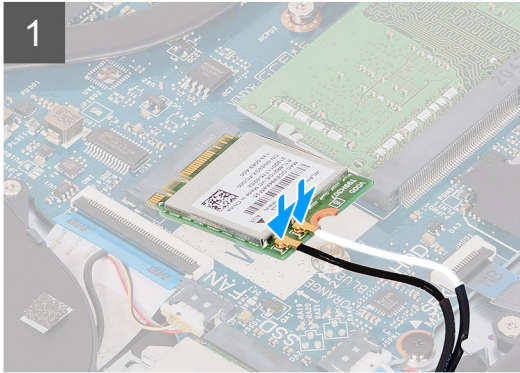
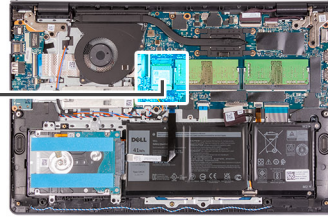

### Steps

1. Connect the antenna cables to the wireless card.

The following table provides the antenna-cable color scheme for the wireless card supported by your computer.

**Table 2. WLAN Antenna Cables**

Connectors on the wireless card	Antenna-cable color
Main(white triangle)	White
Auxiliary(black triangle)	Black

2. Slide the wireless card into the M.2 card slot on the system board.
3. Place the wireless-card bracket on the wireless card.
4. Replace the single (M2x3) screw to secure the wireless-card bracket and the wireless card to the system board.

### Next steps

1. Install the [base cover](#).
2. Exit [service mode](#).
3. Install the [SD card](#).
4. Follow the procedure in [after working inside your computer](#).



# Solid-state drive

## Removing the M.2 2230 solid-state drive

### Prerequisites

1. Follow the procedure in [before working inside your computer](#).
2. Remove the [SD card](#).
3. Enter [service mode](#).
4. Remove the [base cover](#).

### About this task

The following images indicate the location of the M.2 2230 solid-state drive and provides a visual representation of the removal procedure.



1x  
M2x2

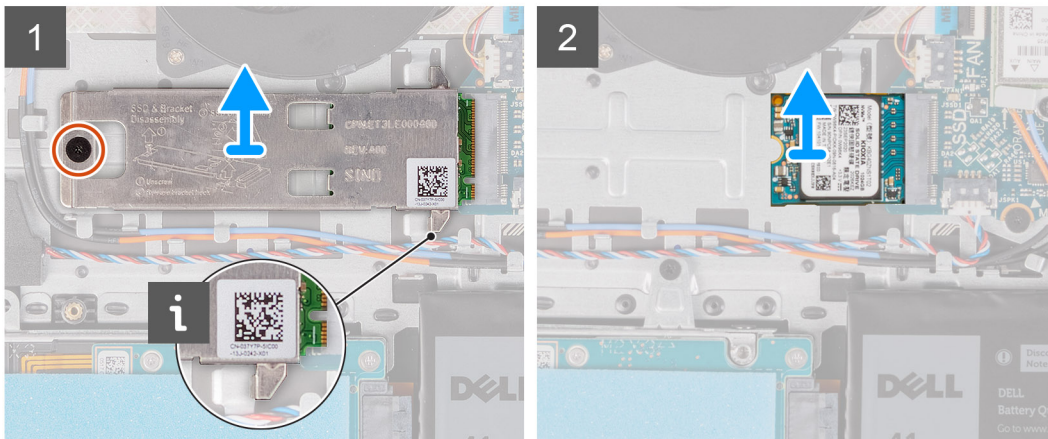
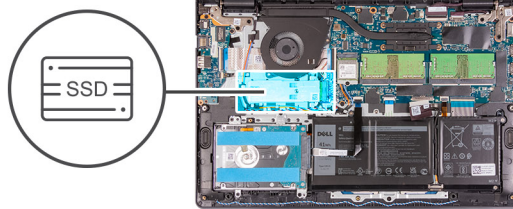

### Steps

1. Remove the single (M2x2) screw that secures the thermal plate to the palm-rest and keyboard assembly.
2. Lift the M.2 2230 solid-state drive thermal plate from over the M.2 2230 solid-state drive.
3. Slide and remove the M.2 2230 solid-state drive from the M.2 card slot on the system board.

## Installing the M.2 2230 solid-state drive

### Prerequisites

If you are replacing a component, remove the existing component before performing the installation procedure.

### About this task

The following images indicate the location of the M.2 2230 solid-state drive and provide a visual representation of the installation procedure.

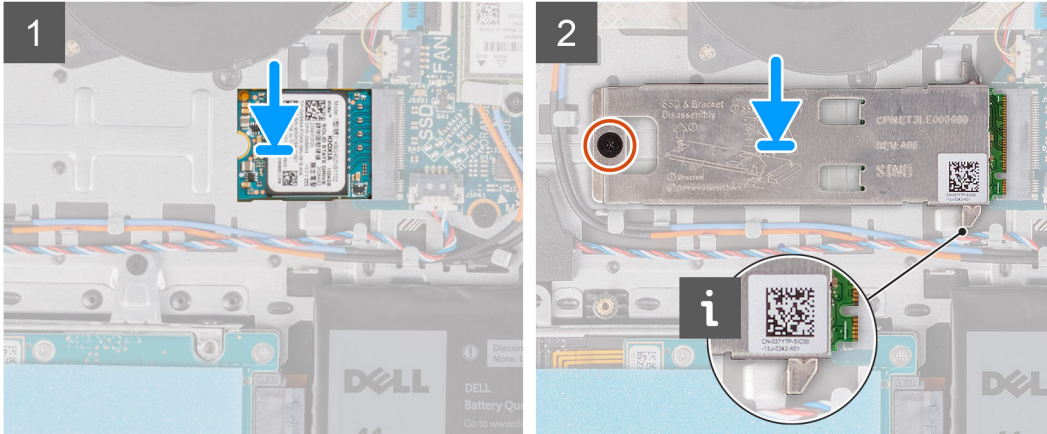
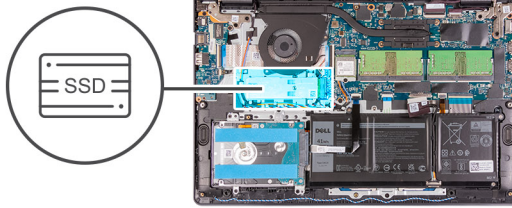

### Steps

1. Align the notch on the M.2 2230 solid-state drive with the tab on the M.2 card slot on the system board.
2. Slide the M.2 2230 solid-state drive into the M.2 card slot on the system board
3. Place the thermal plate on the solid-state drive.

#### **i** NOTE:

When installing the M.2 2230 SSD on the system, tuck the tabs on the thermal plate under the hooks on the palm rest.

4. Align the screw hole on the thermal plate to the screw hole on the palm-rest and keyboard assembly.
5. Replace the screw (M2x2) that secures the thermal plate to the palm-rest and keyboard assembly.

### Next steps

1. Install the [base cover](#).
2. Exit [service mode](#).
3. Install the [SD card](#).
4. Follow the procedure in [after working inside your computer](#).

## Removing the M.2 2280 solid-state drive

### Prerequisites

1. Follow the procedure in [before working inside your computer](#).
2. Remove the [SD card](#).
3. Enter [service mode](#).
4. Remove the [base cover](#).

### About this task

The following images indicate the location of the M.2 2280 solid-state drive and provides a visual representation of the removal procedure.



1x  
M2x2

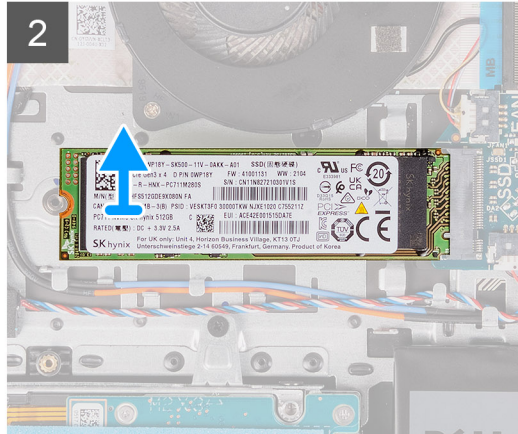
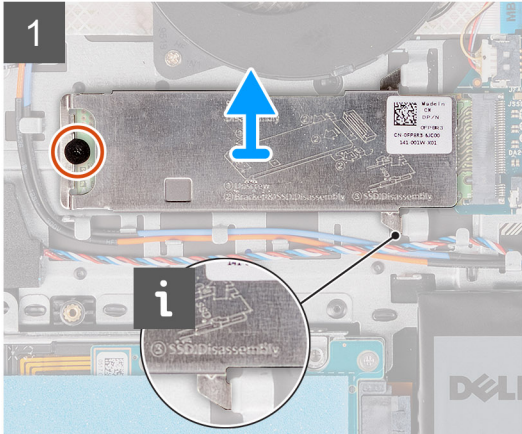

### Steps

1. Remove the screw (M2x2) that secures the thermal plate to the palm-rest and keyboard assembly.
2. Lift the thermal plate from the palm-rest and keyboard assembly.
3. Slide and remove the M.2 2280 solid-state drive from the M.2 card slot on the system board.

## Installing the M.2 2280 solid-state drive

### Prerequisites

If you are replacing a component, remove the existing component before performing the installation procedure.

### About this task

The following images indicate the location of the M.2 2280 solid-state drive and provides a visual representation of the installation procedure.



1x  
M2x2

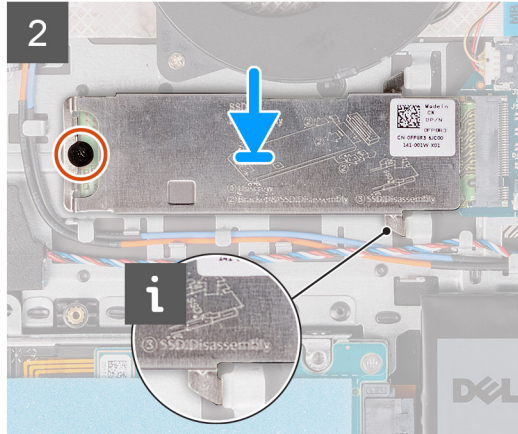
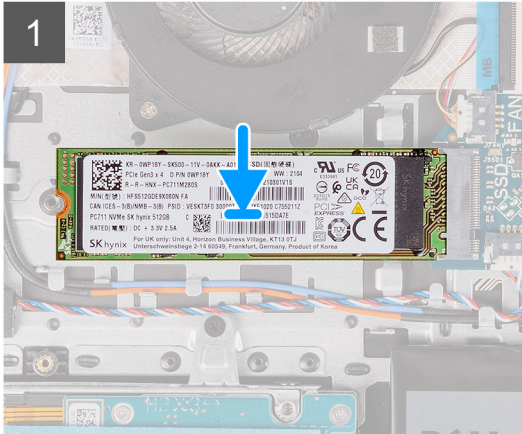

### Steps

1. Align the notch on the M.2 2280 solid-state drive with the tab on the M.2 card slot on the system board.
2. Slide the M.2 2280 solid-state drive into the M.2 card slot on the system board.
3. Place the thermal plate on the M.2 2280 solid-state drive.

**NOTE:** While installing the M.2 2280 solid-state drive on the system, tuck the tabs on the thermal plate under the hooks on the palm rest.

4. Replace the screw (M2x2) that secures the thermal plate to the palm-rest and keyboard assembly.

### Next steps

1. Install the [base cover](#).
2. Exit [service mode](#).
3. Install the [SD card](#).
4. Follow the procedure in [after working inside your computer](#).

## Hard drive

### Removing the hard drive

#### Prerequisites

1. Follow the procedure in [before working inside your computer](#).
2. Remove the [SD card](#).
3. Enter [service mode](#).
4. Remove the [base cover](#).
5. Remove the [battery](#).

#### About this task

The following images indicate the location of the hard drive and provides a visual representation of the removal procedure.



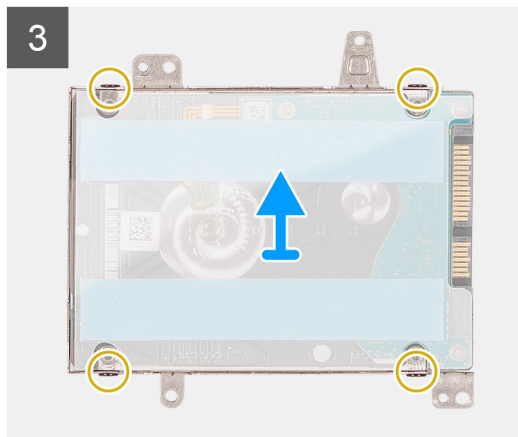
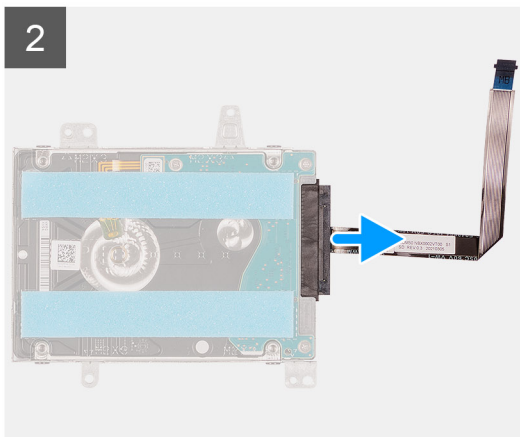
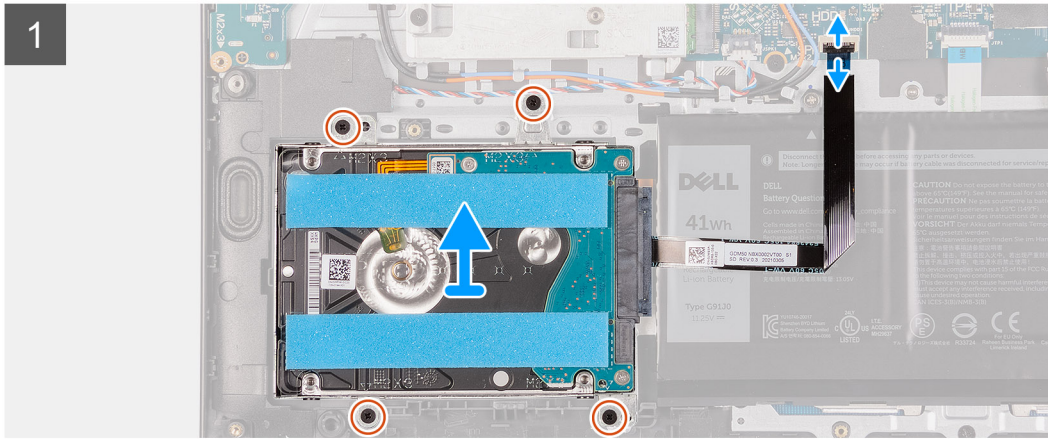
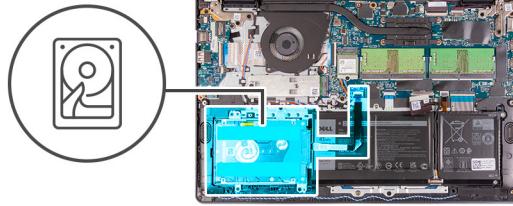

### Steps

1. Lift the latch and disconnect the hard-drive cable from the system board.
2. Remove the three screws (M2x3) that secure the hard-drive assembly to the palm-rest and keyboard assembly.
3. Lift the hard-drive assembly along with its cable from the palm-rest and keyboard assembly.
4. Disconnect the interposer from the hard drive.
5. Remove the four (M3x3) screws from the hard-drive bracket.
6. Slide and remove the hard-drive bracket from the hard drive

## Installing the hard drive

### Prerequisites

If you are replacing a component, remove the existing component before performing the installation procedure.

### About this task

The following images indicate the location of the hard drive and provides a visual representation of the installation procedure.



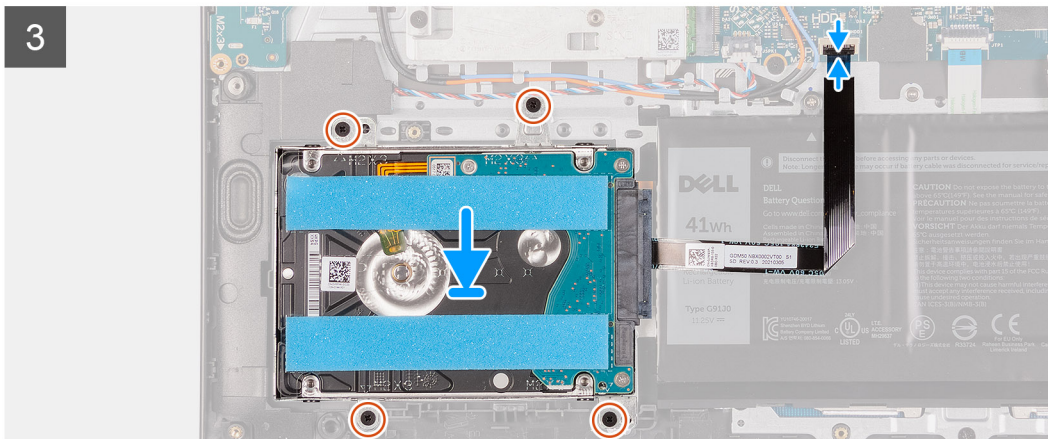
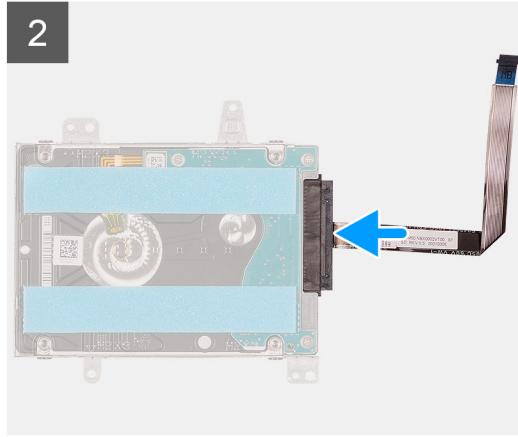
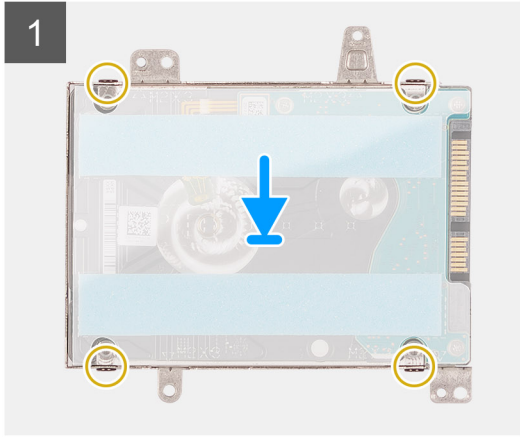
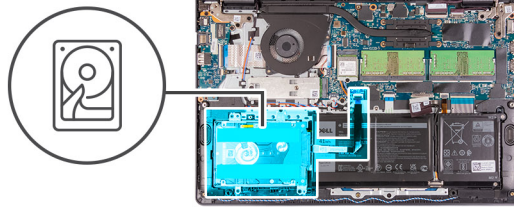

### Steps

1. Slide and install the hard-drive into the hard-drive bracket.
2. Install the four (M3x3) screws to secure the hard drive to the hard-drive bracket.
3. Connect the interposer to the hard drive.
4. Align and place the hard-drive assembly on to the palm-rest and keyboard assembly.
5. Replace the four (M2x3) screws to secure the hard drive assembly to the palm-rest.
6. Connect the hard drive cable to the system board and close the latch to secure the cable.

### Next steps

1. Install the [battery](#).
2. Install the [base cover](#).
3. Exit [service mode](#).
4. Install the [SD card](#).
5. Follow the procedure in [after working inside your computer](#).

# System fan

## Removing the system fan

### Prerequisites

1. Follow the procedure in [before working inside your computer](#).
2. Remove the [SD card](#).
3. Enter [service mode](#).
4. Remove the [base cover](#).

### About this task

The following images indicate the location of the system fan and provides a visual representation of the removal procedure.



2x  
M2x5

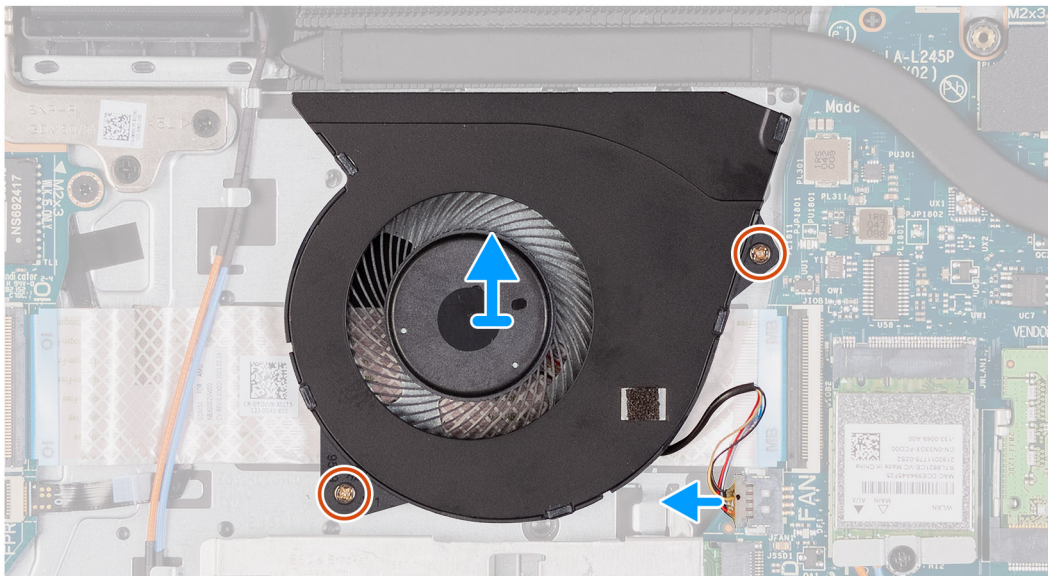
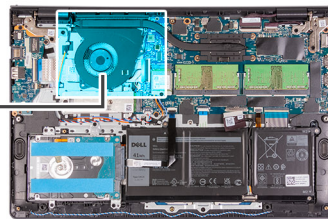
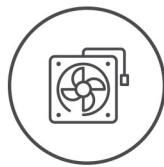

### Steps

1. Disconnect the fan cable from the connector on the system board.
2. Remove the two screws (M2x5) that secures the fan to the palm-rest and keyboard assembly.
3. Lift and remove the fan from the computer.

## Installing the system fan

### Prerequisites

If you are replacing a component, remove the existing component before performing the installation procedure.

### About this task

The following images indicate the location of the system fan and provides a visual representation of the installation procedure.



2x  
M2x5

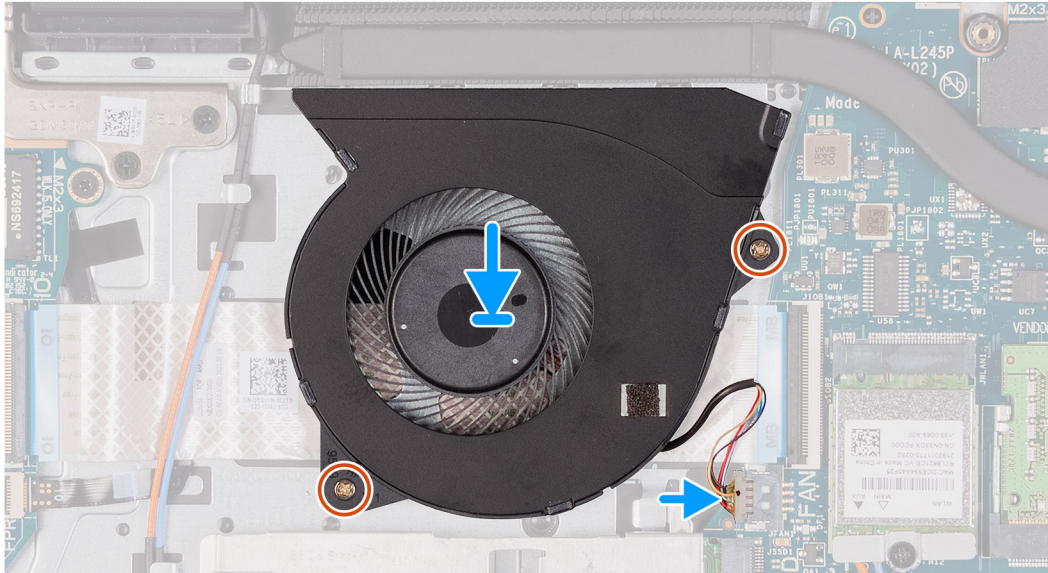
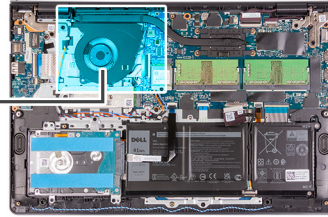
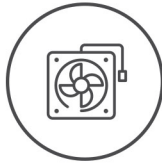

### Steps

1. Align and place the fan on the palm-rest and keyboard assembly.
2. Replace the two screws (M2x5) to secure the fan to the palm-rest and keyboard assembly.
3. Connect the fan cable to the connector on the system board .

### Next steps

1. Replace the [base cover](#).
2. Exit [service mode](#).
3. Replace the [SD card](#).
4. Follow the procedure in [after working inside your computer](#).

## Heat sink

### Removing the heat sink - UMA

#### Prerequisites

1. Follow the procedure in [before working inside your computer](#).
2. Remove the [SD card](#).
3. Enter [service mode](#).
4. Remove the [base cover](#).

#### About this task

The following images indicate the location of the heat sink and provides a visual representation of the removal procedure.





4x  
M2x3

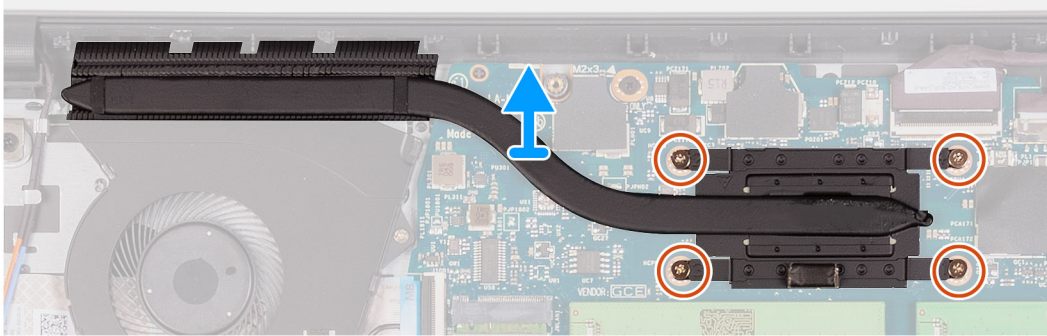
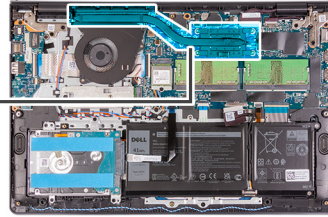

6x  
M2x3

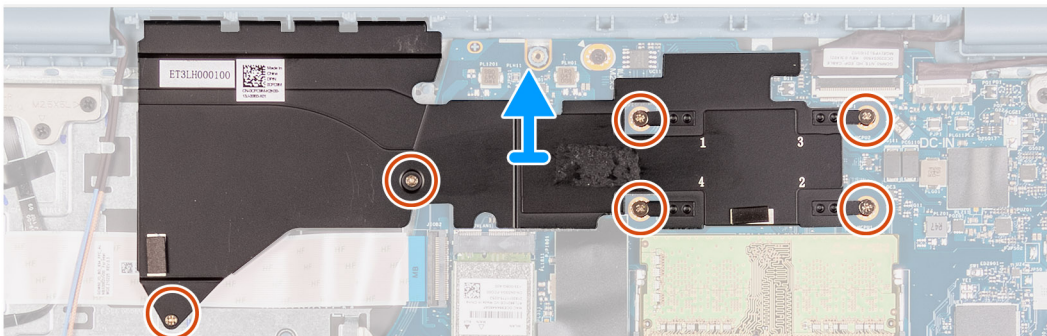
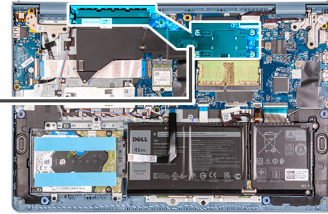

### Steps

1. Loosen the four captive screws that secure the heat sink to the system board.
2. Lift the heat sink off the system board.

## Installing the heat sink - UMA

### Prerequisites

If you are replacing a component, remove the existing component before performing the installation procedure.

### About this task

The following images indicate the location of the heat sink and provides a visual representation of the installation procedure.

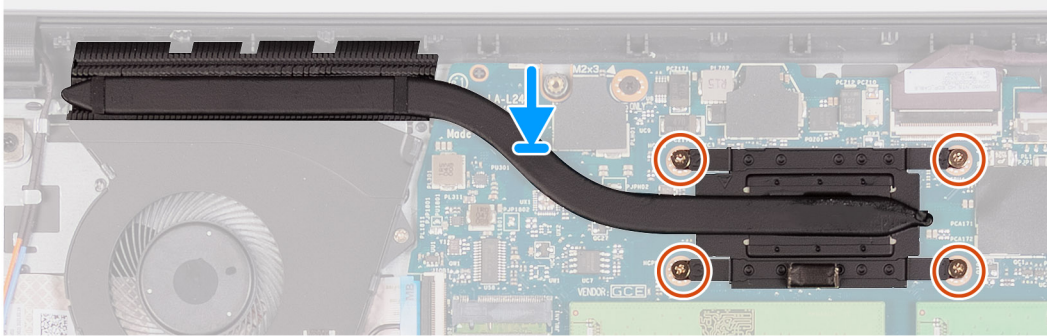
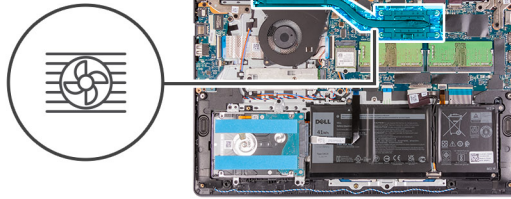

### Steps

1. Place the heat sink on the system board and align the captive screws on the heat sink with the screw holes on the system board.
2. Tighten the four (M2x3) screws to secure the heat sink to the system board.

### Next steps

1. Install the [base cover](#).
2. Exit [service mode](#).
3. Install the [SD card](#).
4. Follow the procedure in [after working inside your computer](#).

## Removing the heat sink - Discrete

### Prerequisites

1. Follow the procedure in [before working inside your computer](#).
2. Remove the [SD card](#).
3. Enter [service mode](#).
4. Remove the [base cover](#).

### About this task

The following images indicate the location of the discrete heat sink and provides a visual representation of the removal procedure.

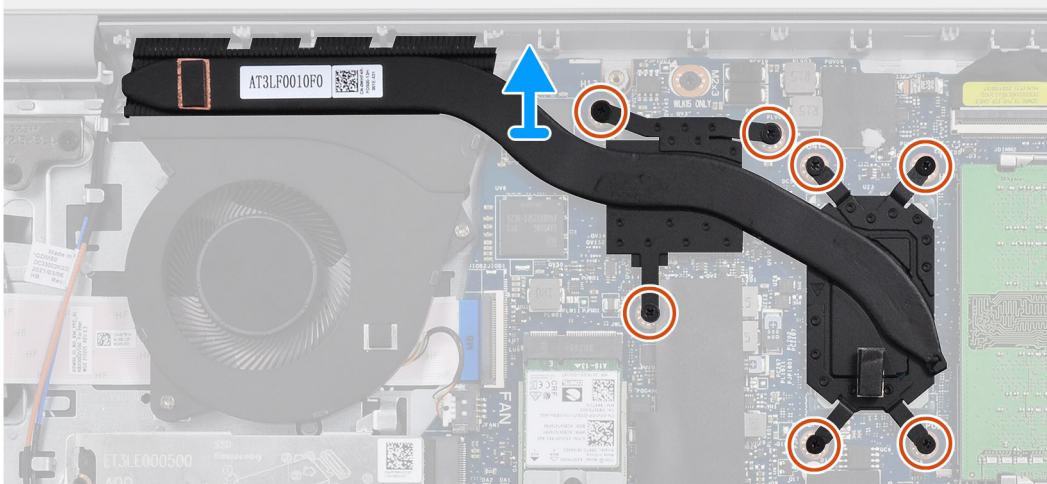
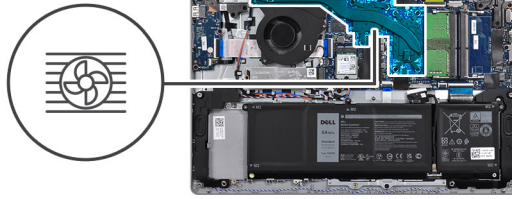

### Steps

1. Remove the seven (M2x3) screws that secure the heat sink to the system board.
2. Lift the heat sink off the system board.

## Installing the heat sink - Discrete

### Prerequisites

If you are replacing a component, remove the existing component before performing the installation procedure.

### About this task

The following images indicate the location of the discrete heat sink and provides a visual representation of the installation procedure.

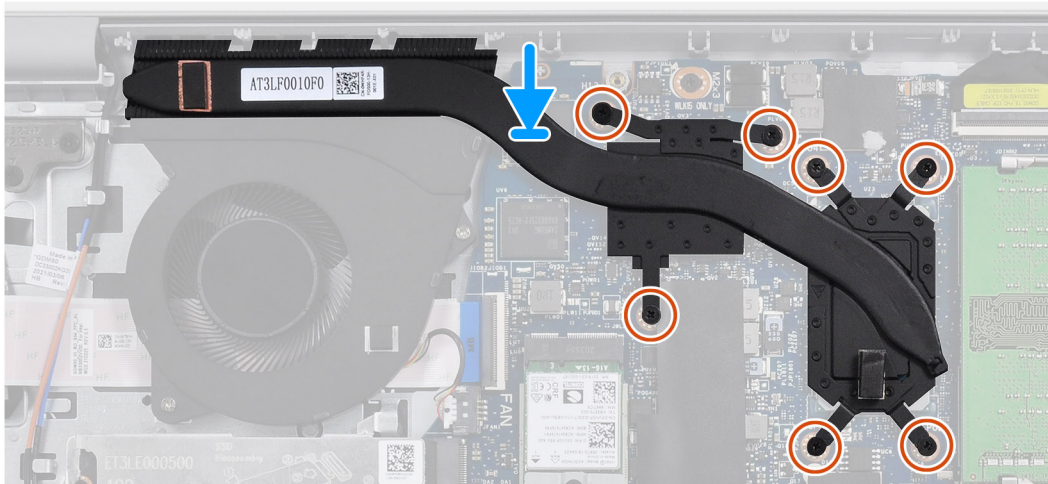
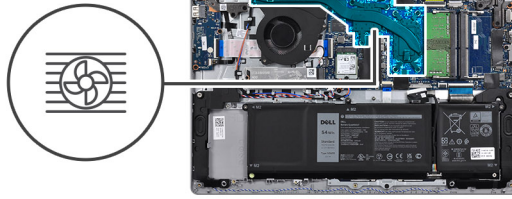

### Steps

1. Place the heat sink on the system board and align the screw holes with the ones on the system board.
2. Replace the seven (M2x3) screws to secure the heat sink to the system board.

### Next steps

1. Install the [base cover](#).
2. Exit [service mode](#).
3. Install the [SD card](#).
4. Follow the procedure in [after working inside your computer](#).

## Speakers

### Removing the speakers

#### Prerequisites

1. Follow the procedure in [before working inside your computer](#).
2. Remove the [SD card](#).
3. Enter [service mode](#).
4. Remove the [base cover](#).

#### About this task

The following images indicate the location of the speakers and provides a visual representation of the removal procedure.



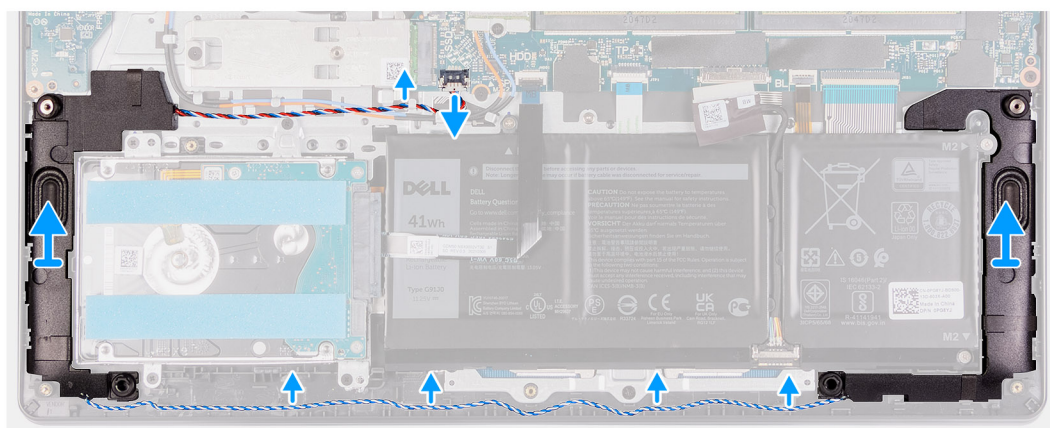
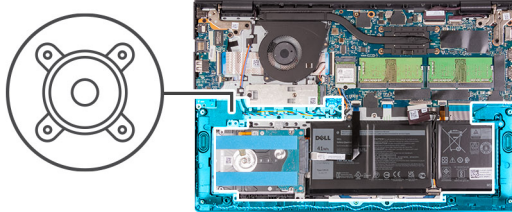

## Steps

1. Disconnect the speaker cable from the system board.
2. Unroute and remove the speaker cable from the routing guides on palm-rest and keyboard assembly.
3. Lift the speakers, along with the cable, off the computer.

## Installing the speakers

### Prerequisites

If you are replacing a component, remove the existing component before performing the installation procedure.

### About this task

The following images indicate the location of the speakers and provides a visual representation of the installation procedure.

**NOTE:** If the rubber grommets are pushed out when removing the speakers, push them back in before replacing the speakers.

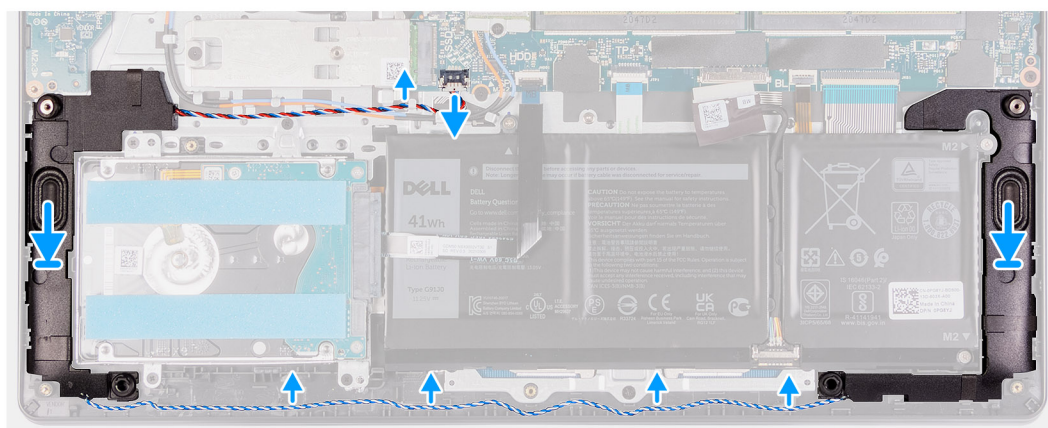
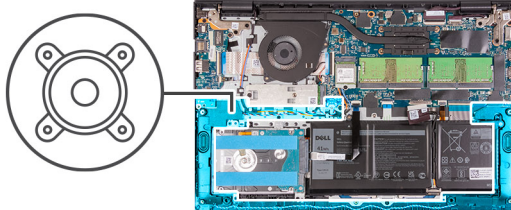

### Steps

1. Using the alignment posts and rubber grommets, place the speakers in the slots on the palm-rest and keyboard assembly.
2. Route the speaker cable through the routing guides on the palm-rest and keyboard assembly..
3. Connect the speaker cable to the connector on the system board .

### Next steps

1. Install the [base cover](#).
2. Exit [service mode](#).
3. Install the [SD card](#).
4. Follow the procedure in [after working inside your computer](#).

## IO board

### Removing the I/O board

#### Prerequisites

1. Follow the procedure in [before working inside your computer](#).
2. Remove the [SD card](#).
3. Enter [service mode](#).
4. Remove the [base cover](#).

#### About this task

The following images indicate the location of the I/O board and provides a visual representation of the removal procedure.

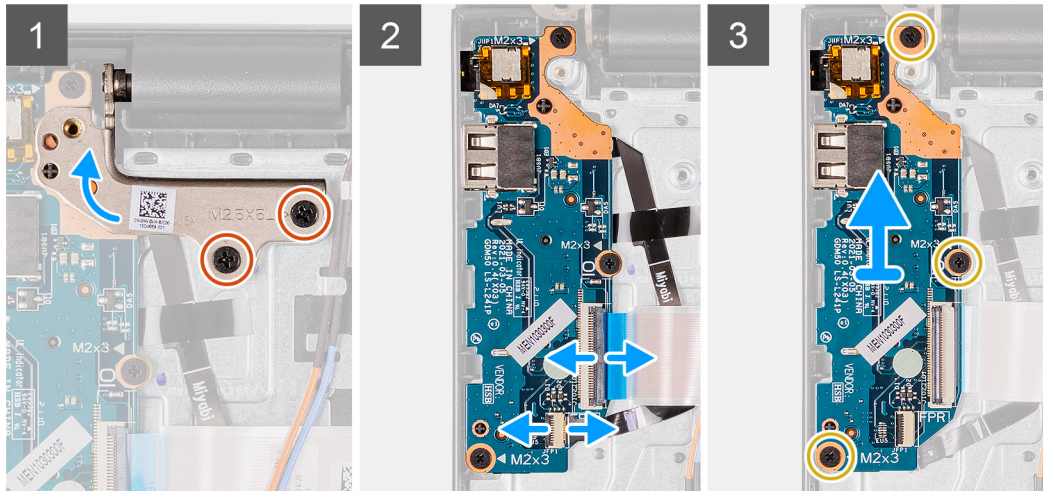
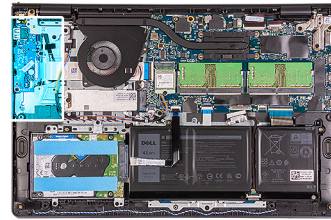

### Steps

1. Remove the two (M2.5x5) screws that secure the left hinge to the palm-rest and keyboard assembly.
2. Fold up the left hinge.
3. Open the latch and disconnect the fingerprint-reader board cable from the I/O board, if applicable.
4. Open the latch and disconnect the I/O-board power cable from the I/O board.
5. Remove the three (M2x3) screws that secure the I/O board to the palm-rest and keyboard assembly, and remove the I/O board from the system.

## Installing the I/O board

### Prerequisites

If you are replacing a component, remove the existing component before performing the installation procedure.

### About this task

The following images indicate the location of the I/O board and provides a visual representation of the installation procedure.

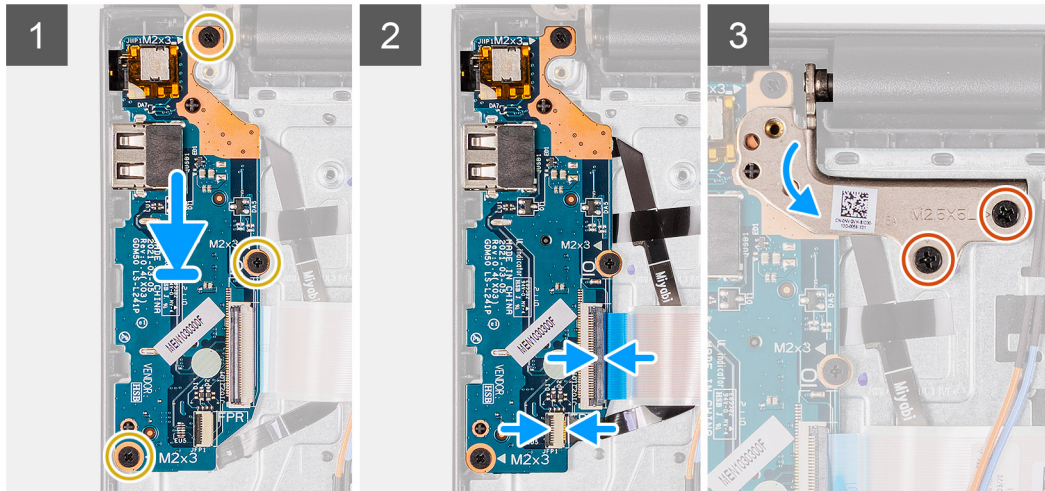
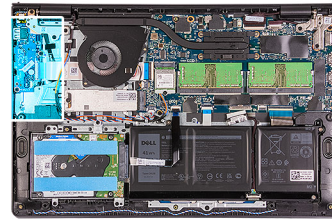

### Steps

1. Align and place the I/O board under the left hinge assembly and on to the palm-rest and keyboard assembly.
2. Replace the three (M2x3) screws to secure the I/O daughter board to the palm-rest and keyboard assembly.
3. Connect the fingerprint-reader board cable to the connector on the I/O board and close the latch, if applicable.
4. Connect the I/O-board power cable to the connector on the I/O board and close the latch.
5. Fold back the left hinge over the I/O board.
6. Replace the two (M2.5x5) screws to secure the hinge to the palm-rest and keyboard assembly.

### Next steps

1. Install the [base cover](#).
2. Exit [service mode](#).
3. Install the [SD card](#).
4. Follow the procedure in [after working inside your computer](#).

## Touchpad

### Removing the touchpad assembly

#### Prerequisites

1. Follow the procedure in [before working inside your computer](#).
2. Remove the [SD card](#).
3. Remove the [base cover](#).
4. Remove the [battery](#).

#### About this task

The following images indicate the location of the touchpad and provides a visual representation of the removal procedure.





5x  
M2x2

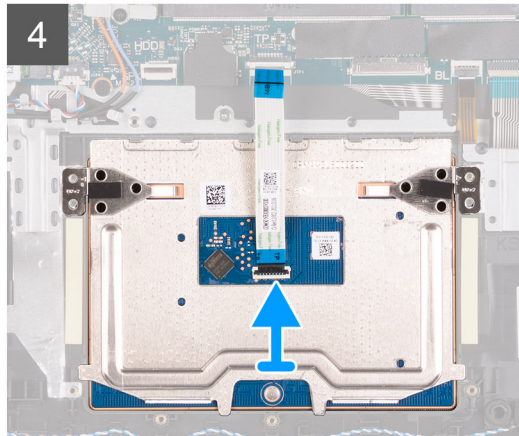
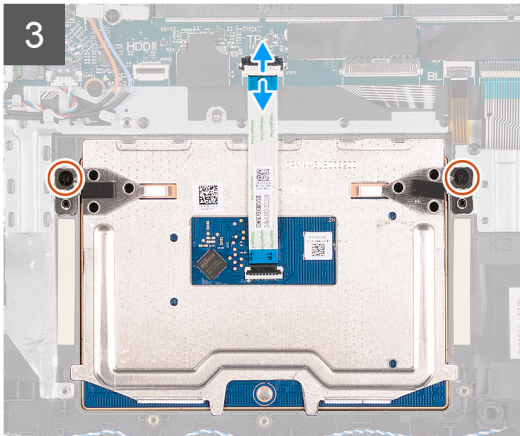
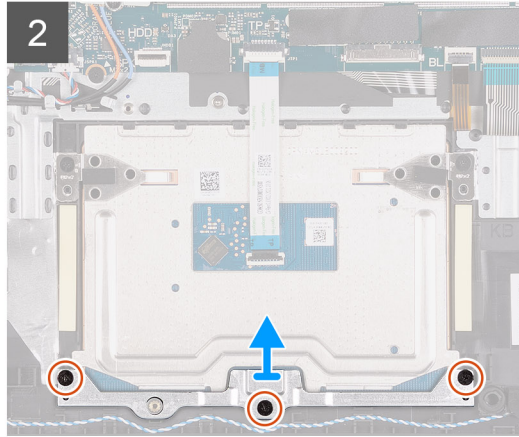
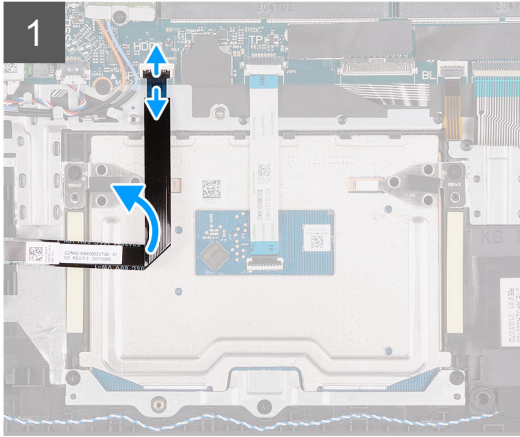
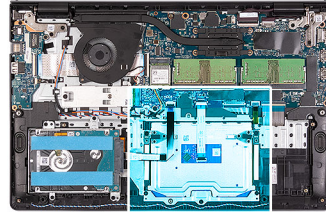

### Steps

1. Disconnect the hard-drive FFC from the system board.
2. Remove the three (M2x2) screws securing the touchpad bracket to the palm-rest and keyboard assembly.
3. Remove the touchpad bracket from the computer.
4. Remove the two (M2x2) screws securing the touchpad module in palm-rest and keyboard assembly.
5. Disconnect the touchpad FFC from the system board.
6. Remove the touchpad module with touchpad FFC from the computer.

## Installing the touch pad assembly

### About this task

The following images indicate the location of the touchpad and provides a visual representation of the installation procedure.

**NOTE:** Ensure that the touch pad is aligned with the guides available on the palm-rest and keyboard assembly, and the gap on either sides of the touch pad is equal.





5x  
M2x2

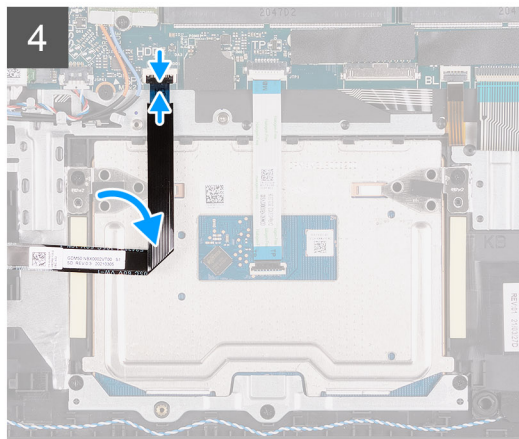
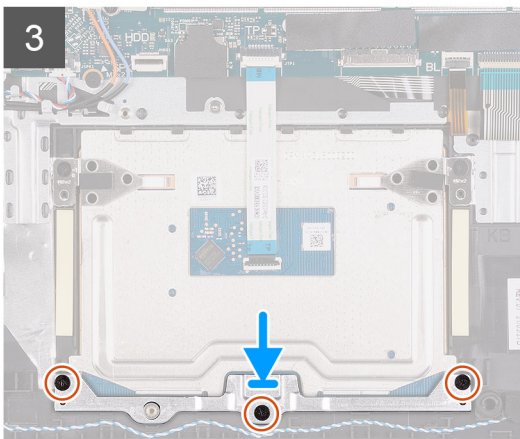
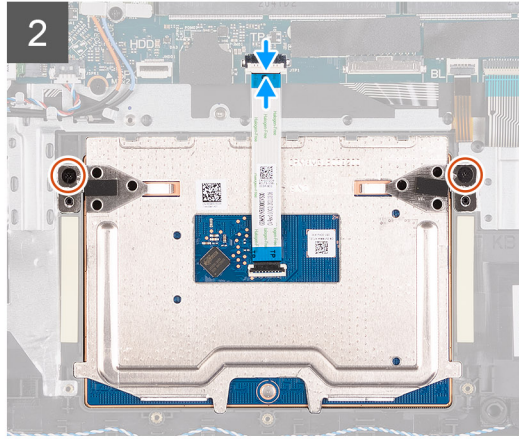
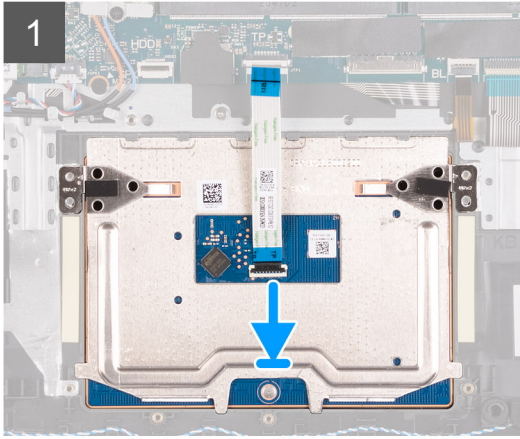
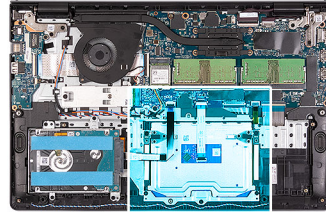

### Steps

1. Align and place the touchpad module onto the computer.
2. Reconnect the touchpad FFC to the touchpad module.
3. Install the two (M2x2) screws to secure the touchpad module to the palm-rest and keyboard assembly.
4. Install the touchpad bracket on the touchpad and secure it using the three (M2x2) screws.
5. Reconnect the hard-drive FFC to the system board.

### Next steps

1. Install the [battery](#).
2. Install the [base cover](#).
3. Install the [SD card](#).
4. Follow the procedure in [after working inside your computer](#).

# Display assembly

## Removing the display assembly

**CAUTION:** The maximum operating angle for the display-panel hinge is 135 degrees.

### Prerequisites

1. Follow the procedure in [before working inside your computer](#).
2. Remove the [SD card](#).
3. Enter [service mode](#).
4. Remove the [base cover](#).
5. Remove the [WLAN card](#).

### About this task

The following images indicate the location of the display assembly and provides a visual representation of the removal procedure.



**4x**  
M2.5x5

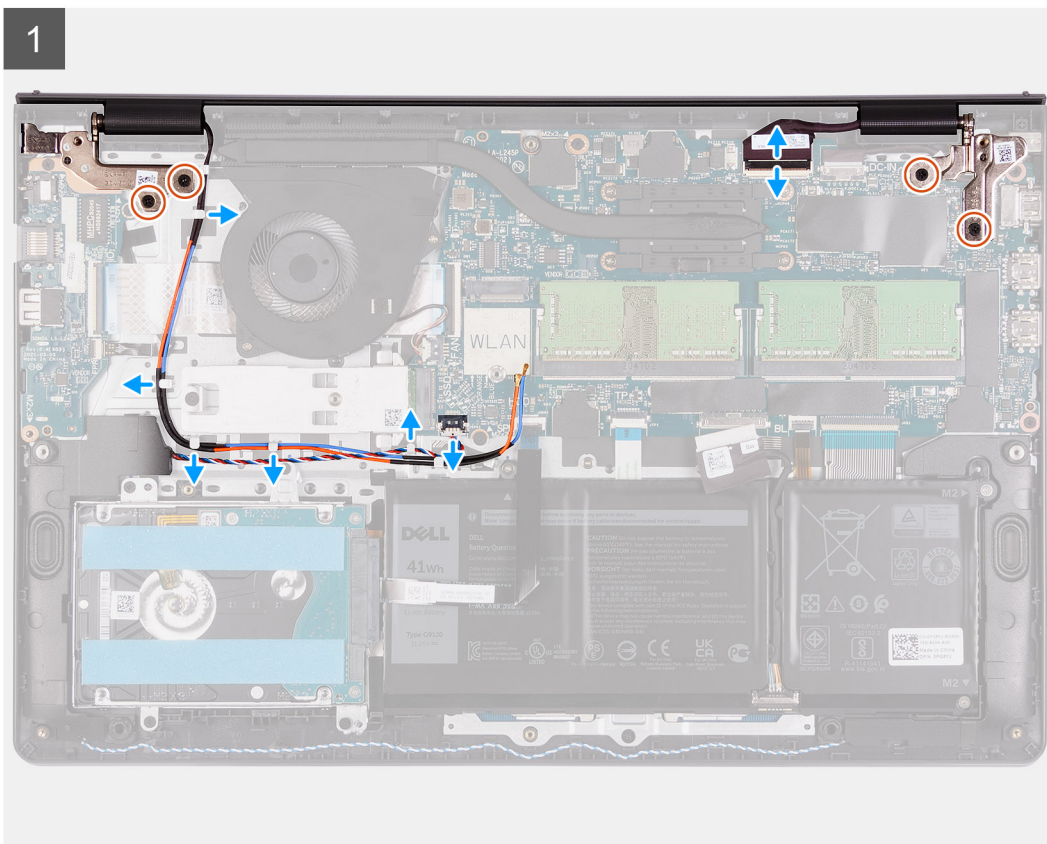
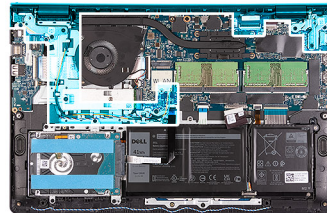



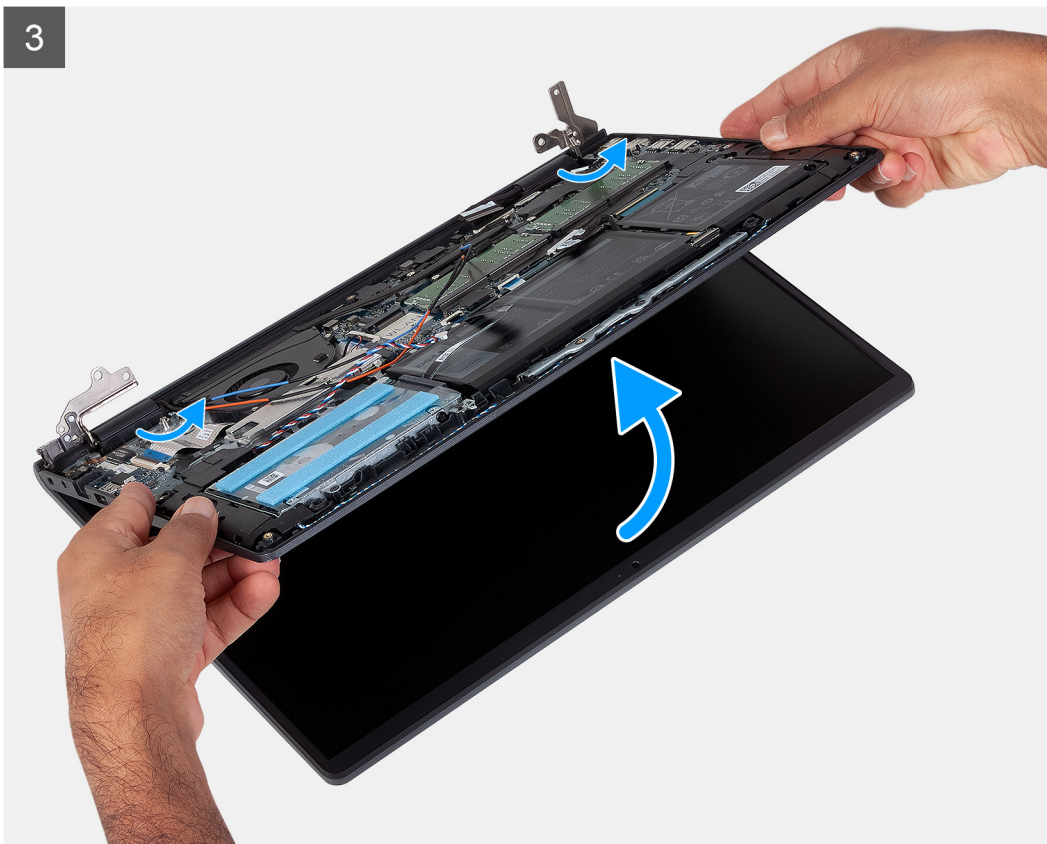
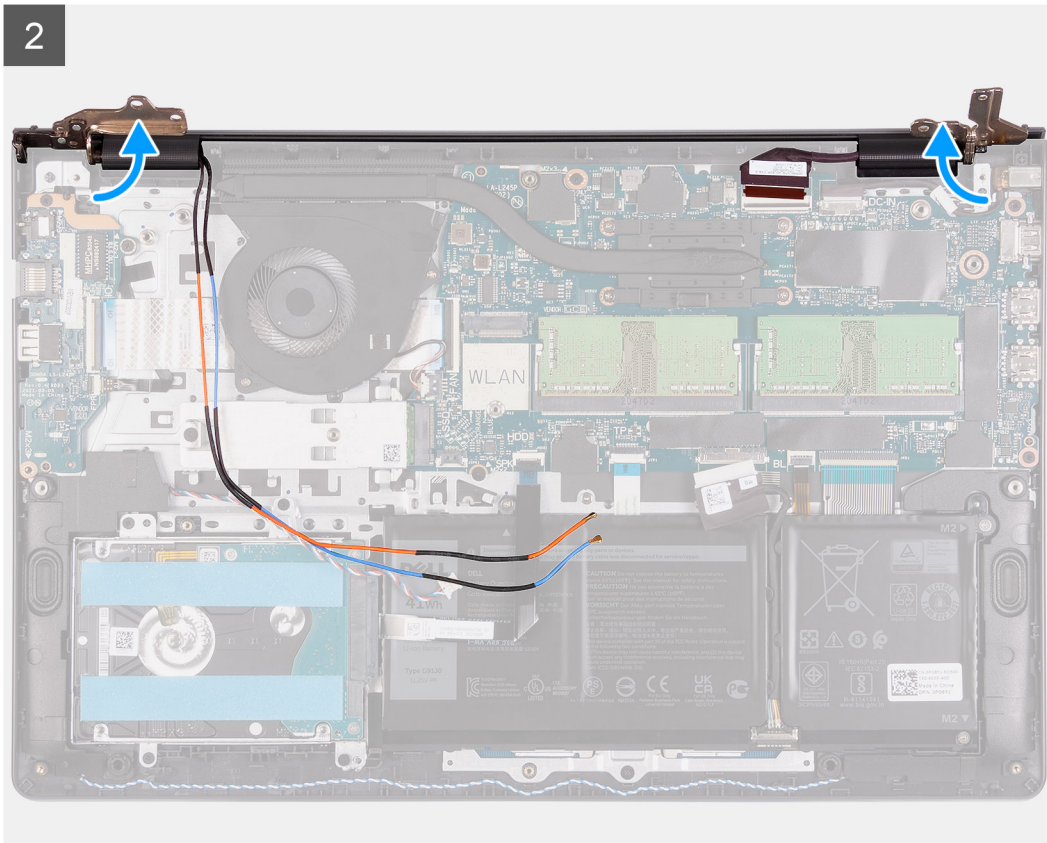

### Steps

1. Disconnect the display cable from the connector on the system board.
2. Unroute the WLAN antenna cables and the speaker cables from the routing guides on the computer.

3. Remove the six (M2.5x5) screws that secure the display hinges to the palm-rest and keyboard assembly.
4. Fold the left and right hinges away from the palm-rest and keyboard assembly.
5. Lift the palm-rest and keyboard assembly at an angle to free it from the hinges and remove it from the display assembly.

## Installing the display assembly

**CAUTION:** The maximum operating angle for the display-panel hinge is 135 degrees.

**NOTE:** Ensure that the hinges are opened to the maximum before replacing the display assembly on the palmrest and keyboard assembly.

### Prerequisites

If you are replacing a component, remove the existing component before performing the installation procedure.

### About this task



4x  
M2.5x5

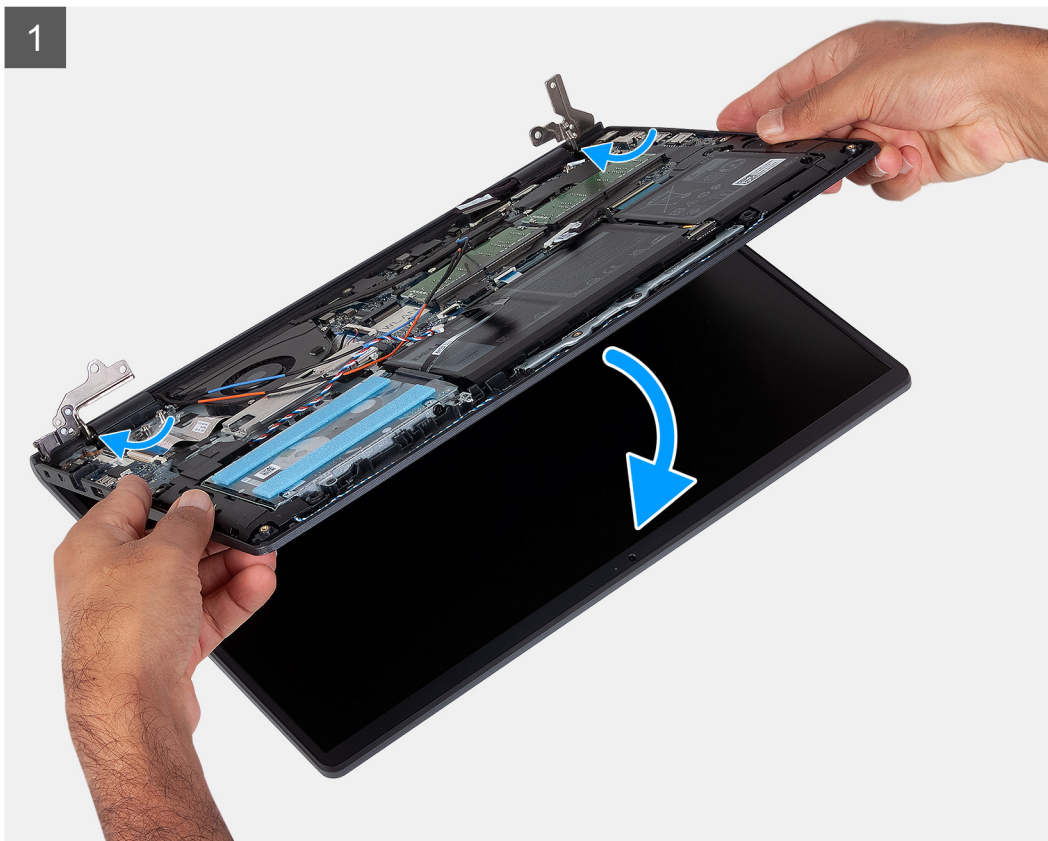
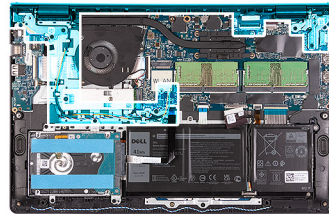



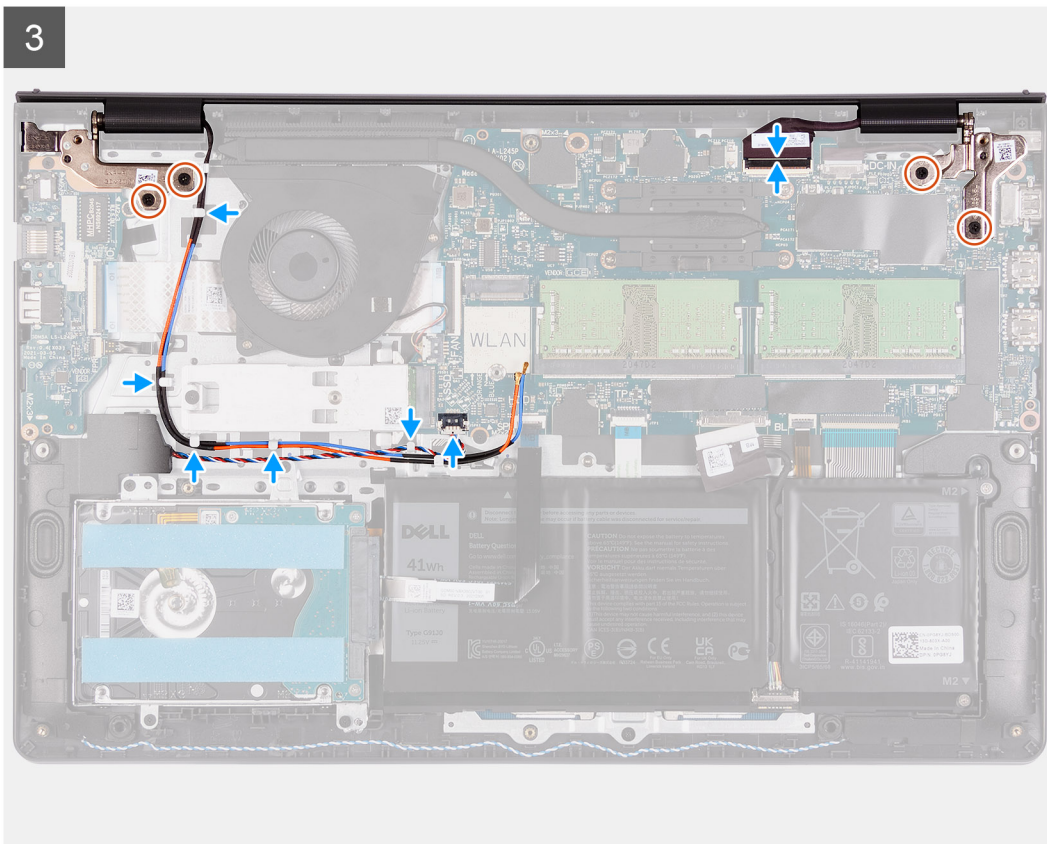
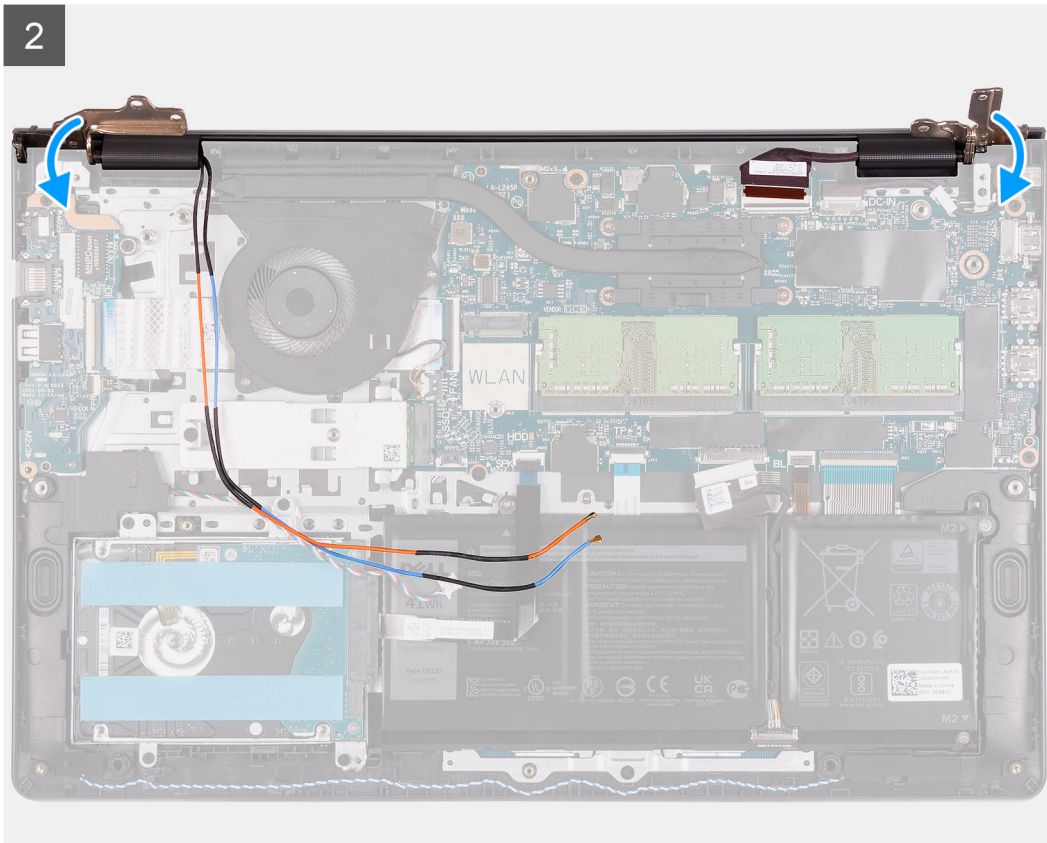

**Steps**

1. Align and place the system under the hinges on the display assembly.
2. Fold the hinges back and install the four (M2.5x5) screws to secure the display assembly.



3. Re-route the speaker and WLAN antenna cables through the routing channels on the palmrest.
4. Reconnect the display cable to the connector on the system board.

#### **Next steps**

1. Install the [WLAN card](#).
2. Install the [base cover](#).
3. Exit [service mode](#).
4. Install the [SD card](#).
5. Follow the procedure in [after working inside your computer](#).

## Hinge caps

### Removing the hinge caps

#### **Prerequisites**

1. Follow the procedure in [Before working inside your computer](#).
2. Remove the [SD card](#).
3. Enter [service mode](#).
4. Remove the [base cover](#).
5. Remove the [WLAN card](#).
6. Remove the [display assembly](#).

#### **About this task**

The following images indicate the location of the hinge caps and provides a visual representation of the installation procedure.

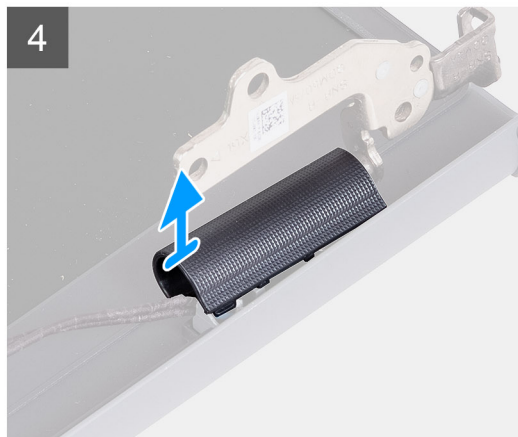
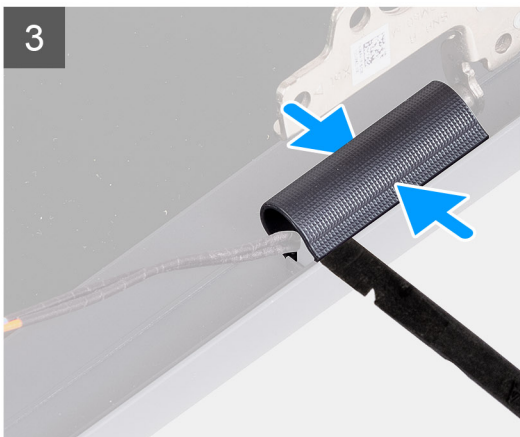
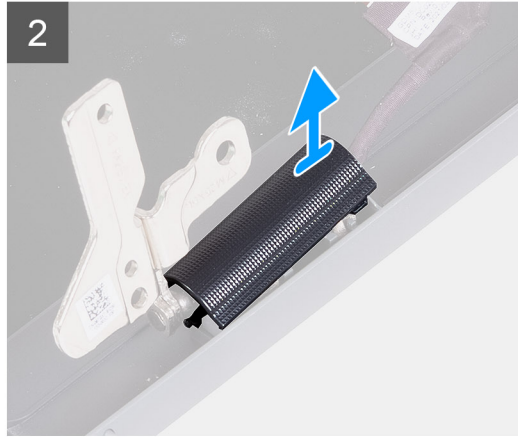
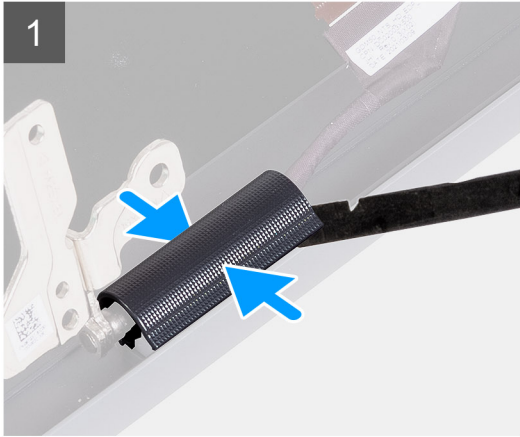
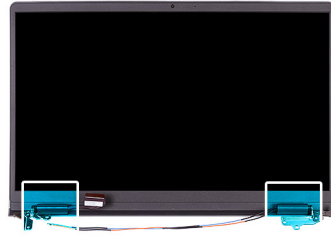

### Steps

**(i) NOTE:** Before removing the display hinge caps, open the display hinges to at least 90 degrees.

1. Pinch the left-hinge cap in the center.
2. Use the scribe to pry open the left-hinge cap from the openings on its inner side.
3. Lift the inner side of the left-hinge cap and remove it from the left hinge.
4. Pinch the right hinge cap in the center.
5. Use the scribe to pry open the right-hinge cap from the openings on its inner side.
6. Lift the inner side of the right-hinge cap and remove it from the right hinge.

## Installing the hinge caps

### Prerequisites

If you are replacing a component, remove the existing component before performing the installation procedure.

### About this task

The following images indicate the location of the hinge caps and provides a visual representation of the installation procedure.

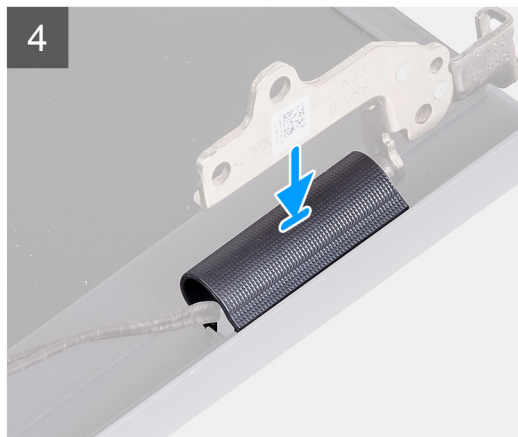
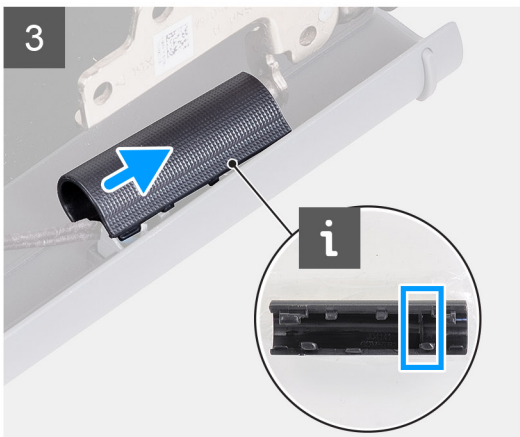
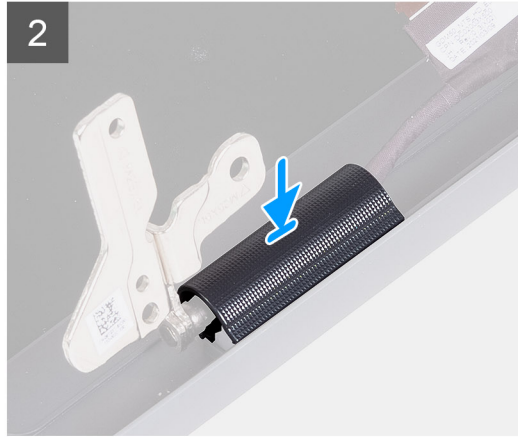
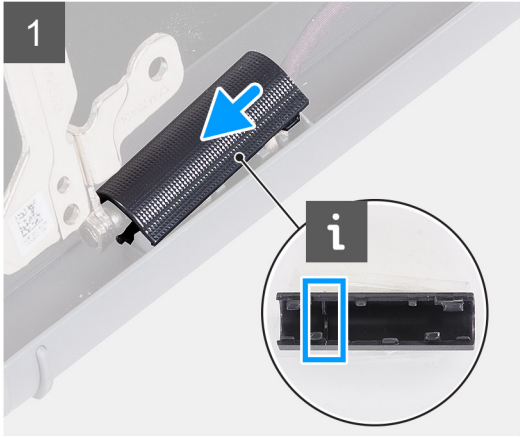
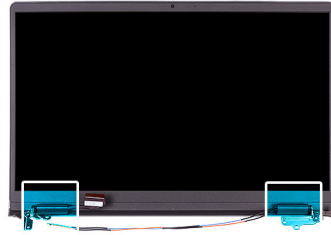

### Steps

1. Align the rib inside the left-hinge cap to the outer sides.
2. Push the left-hinge cap down until it clicks in place.
3. Align the rib inside the right-hinge cap to the outer sides.
4. Push the right-hinge cap down until it clicks in place.

### Next steps

1. Install the [display assembly](#).
2. Install the [WLAN card](#).
3. Install the [base cover](#).
4. Exit [service mode](#).
5. Install the [SD card](#).
6. Follow the procedure in [after working inside your computer](#).

# Display bezel

## Removing the display bezel

### Prerequisites

1. Follow the procedure in [before working inside your computer](#).
2. Remove the [SD card](#).
3. Enter [service mode](#).
4. Remove the [base cover](#).
5. Remove the [display assembly](#).

### About this task

The following images indicate the location of the display bezel and provide a visual representation of the removal procedure.

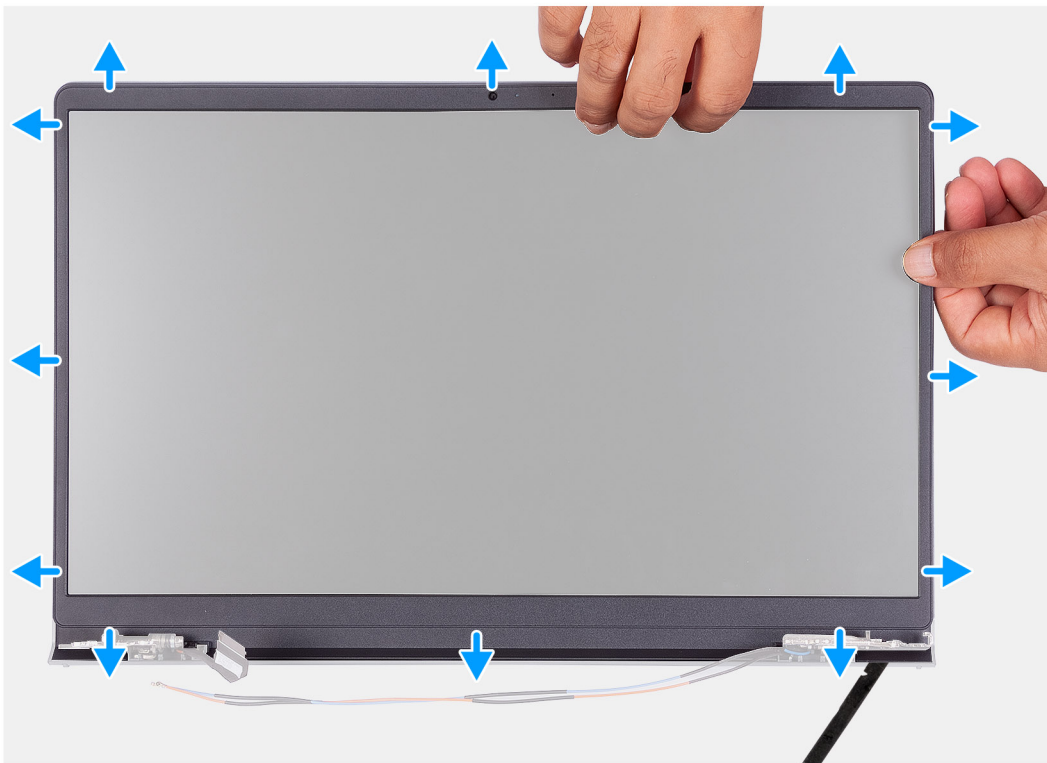

### Steps

1. Use a plastic scribe to pry open the display bezel from the outer edge at the left and right sides of the display hinges.  
**i** **NOTE:** The display bezel is adhered to the display panel with adhesive. Insert a plastic scribe into the recesses near both hinge caps to start the prying process to release the display bezel. Pry along the outside edge of the display bezel and work your way around the entire display bezel until the display bezel is separated from the display cover.

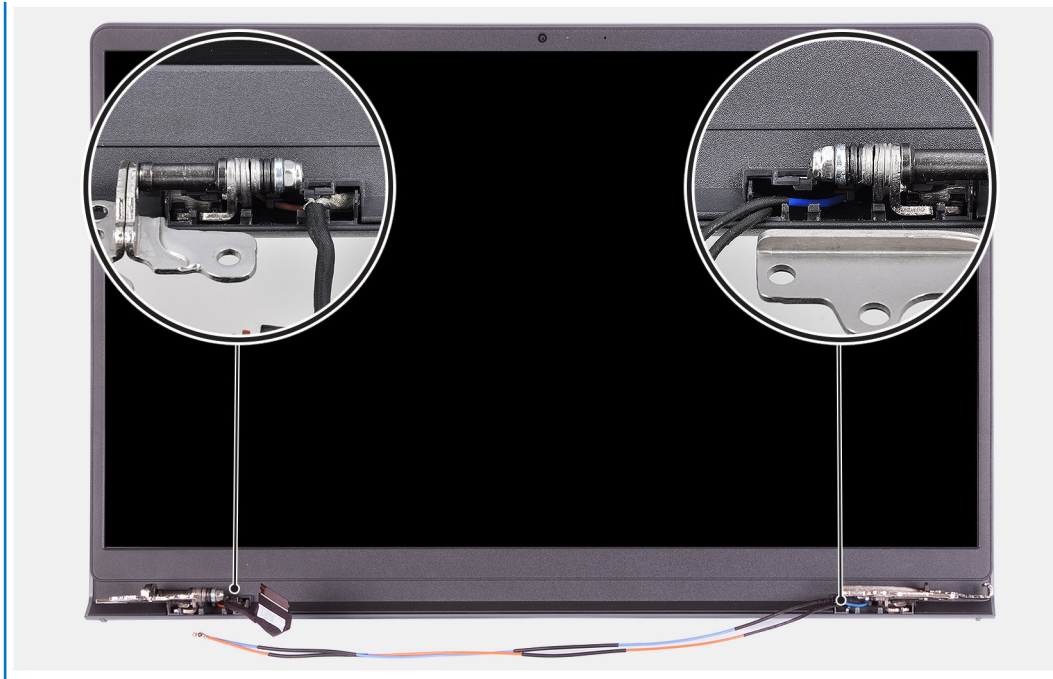

2. Carefully pry the bezel along the edges with your fingers.

**i** **NOTE:** Do not use a scribe or any other objects, and apply pressure to the display panel to avoid damaging the display panel.

3. Work around the edge of the display assembly to pry the display bezel from the display assembly.
4. Lift and remove the display bezel from the display assembly.

## Installing the display bezel

### Prerequisites

If you are replacing a component, remove the existing component before performing the installation procedure.

### About this task

The following images indicate the location of the display bezel and provides a visual representation of the installation procedure.



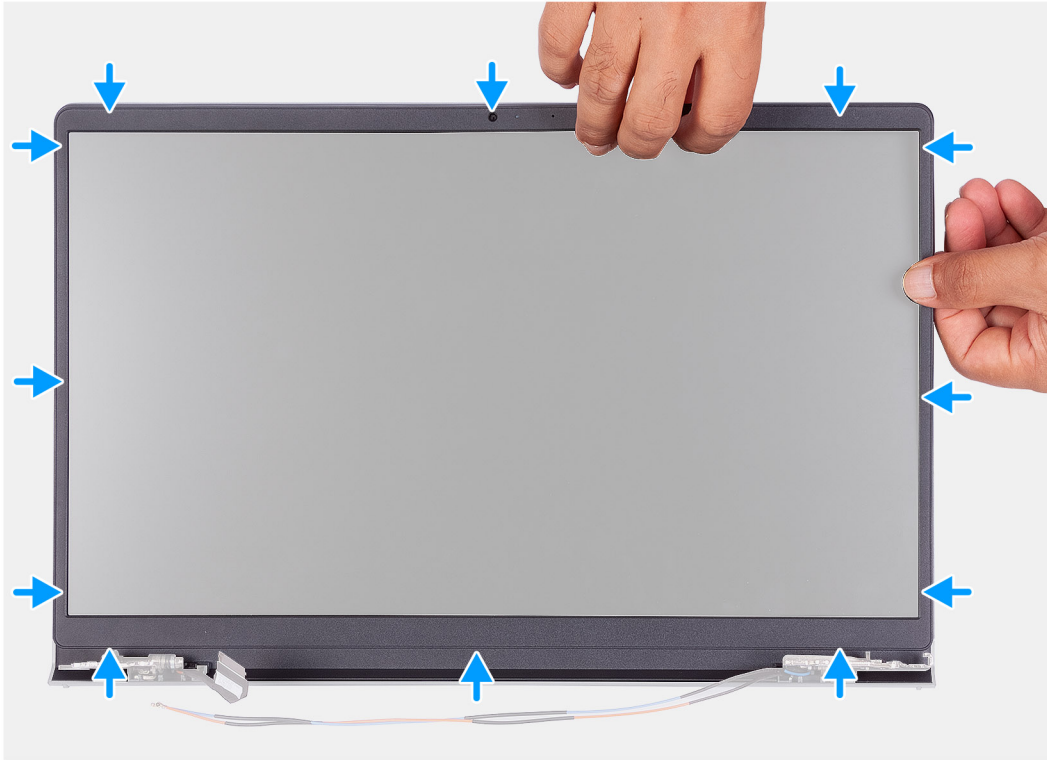

### Steps

1. Place the display panel and display assembly on a clean and flat surface.
2. Place the display bezel on the display assembly.
3. Align the tabs on the display bezel to the slots on the display assembly.
4. Press down on the display bezel and snap the display bezel in place.

### Next steps

1. Install the [display assembly](#).
2. Install the [base cover](#).
3. Exit [service mode](#).
4. Install the [SD card](#).
5. Follow the procedure in [after working inside your computer](#).

## Hinges

### Removing the hinges

#### Prerequisites

1. Follow the procedure in [Before working inside your computer](#).
2. Remove the [SD card](#).

3. Enter [service mode](#).
4. Remove the [base cover](#).
5. Remove the [WLAN card](#).
6. Remove the [display assembly](#).
7. Remove the [hinge caps](#).
8. Remove the [display bezel](#).

**About this task**

The following images indicate the location of the hinge caps and provides a visual representation of the installation procedure.



**6x**  
M2.5x3.8

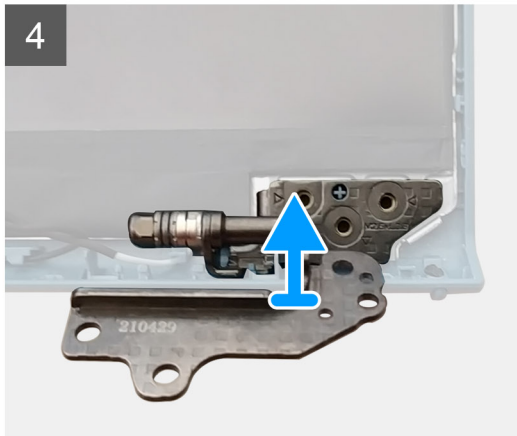
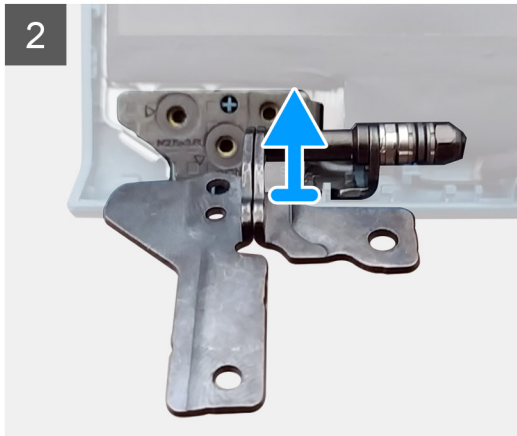
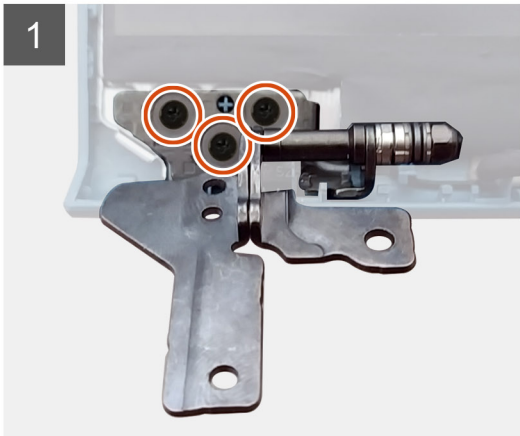

**Steps**

1. Remove the three (M2.5x3.8) from the left hinge.
2. Lift and remove the left hinge from the display assembly.
3. Remove the three (M2.5x3.8) from the right hinge.
4. Lift and remove the right hinge from the display assembly.

# Installing the hinges

## Prerequisites

If you are replacing a component, remove the existing component before performing the installation procedure.

## About this task

The following images indicate the location of the hinges and provides a visual representation of the installation procedure.



**6x**  
M2.5x3.8

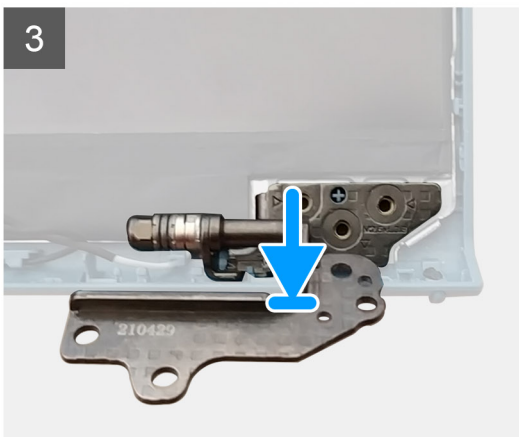
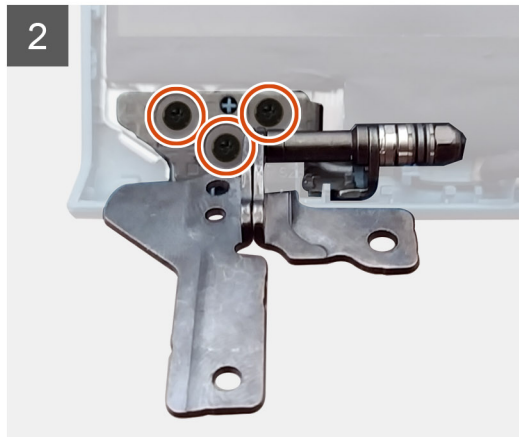
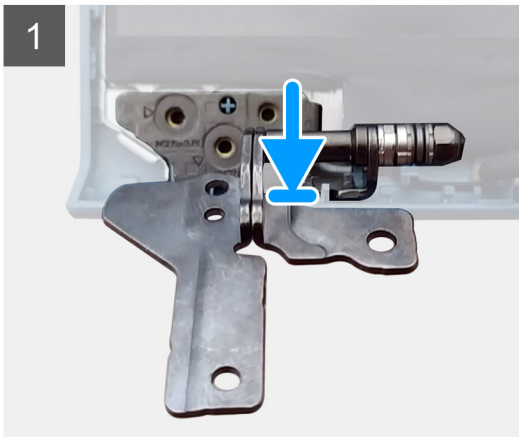

## Steps

1. Align and place the left hinge on the display assembly.
2. Install the three (M2.5x3.8) screws to secure the hinge to the display panel and back cover.
3. Align and place the right hinge on the display assembly.
4. Install the three (M2.5x3.8) screws to secure the hinge to the display panel and back cover.

## Next steps

1. Install the [display bezel](#).
2. Install the [hinge caps](#).
3. Install the [display assembly](#).

4. Install the [WLAN card](#).
5. Install the [base cover](#).
6. Exit [service mode](#).
7. Install the [SD card](#).
8. Follow the procedure in [after working inside your computer](#).

## Display panel

### Removing the display panel

#### Prerequisites

1. Follow the procedure in [before working inside your computer](#).
2. Remove the [SD card](#).
3. Enter [service mode](#).
4. Remove the [base cover](#).
5. Remove the [WLAN card](#).
6. Remove the [display assembly](#).
7. Remove the [hinge caps](#).
8. Remove the [display bezel](#).

#### About this task

The following images indicate the location of the display panel and provides a visual representation of the removal procedure.

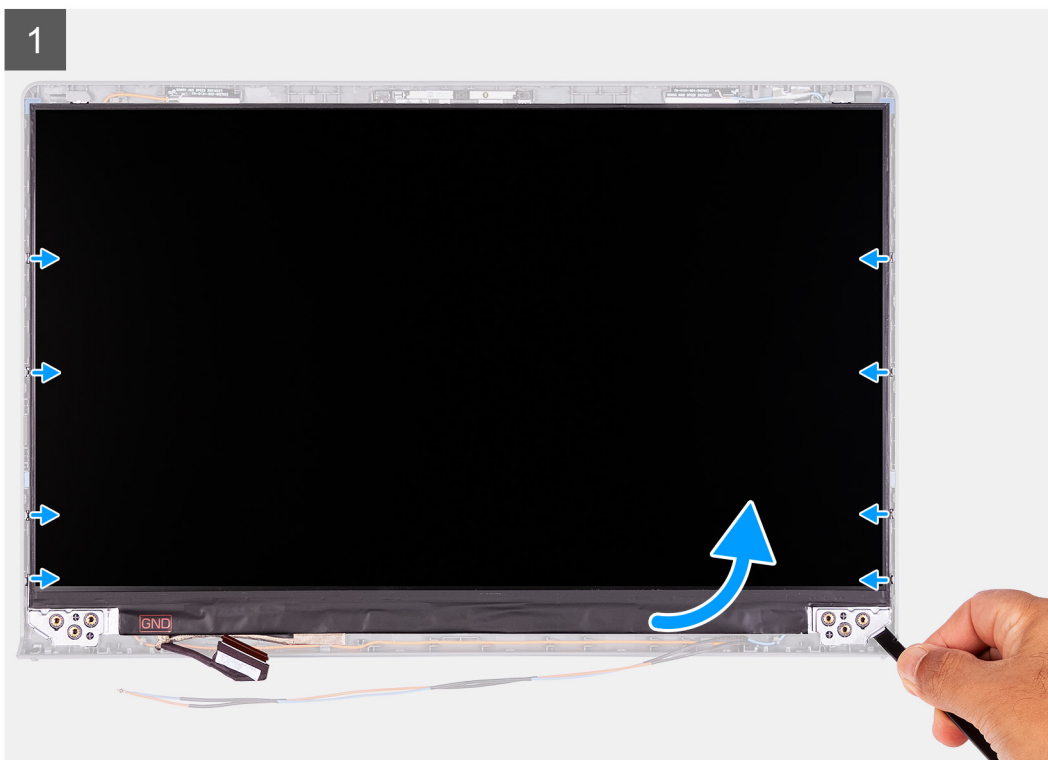
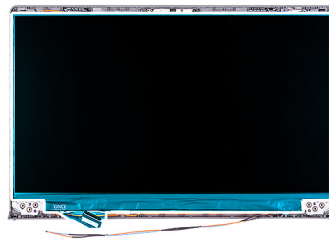





### Steps

1. Use a plastic scribe to pry the display panel from the bottom-right corner.
2. Gently start prying the display panel along the left and right sides of the display back-cover using your hands.
3. Lift the bottom side of the display panel and slide it downward to release the display brackets from the slots at the top side of the display cover.
4. Gently flip the display panel assembly forward, peel back the Mylar tape securing the display cable on the rear of the display panel.

**NOTE:** Ensure that the panel has a clean and smooth surface to rest on to prevent damage.

5. Disconnect the display cable from the display panel assembly and lift the display panel away from the system.

**NOTE:** Do not remove the metal brackets from the panel.

## Installation display panel

### Prerequisites

If you are replacing a component, remove the existing component before performing the installation procedure.

### About this task

The following images indicate the location of the display panel and provides a visual representation of the installation procedure.

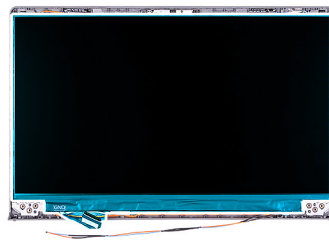

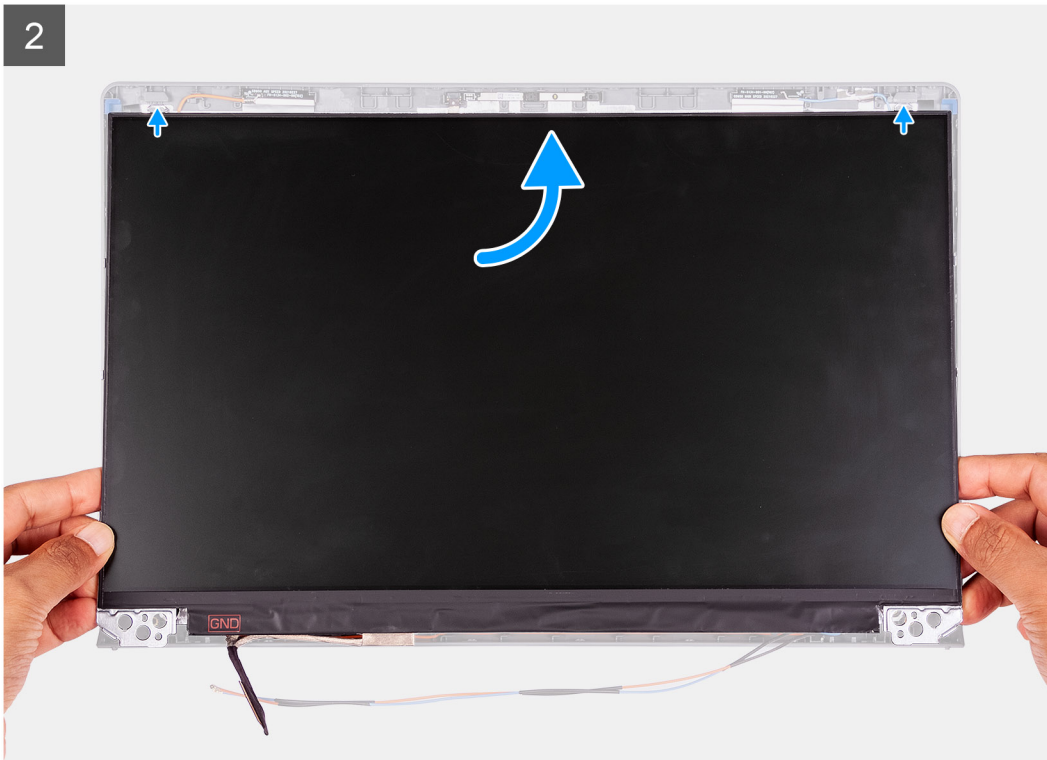

### Steps

1. Place the display panel on a flat and clean surface .
2. Connect the display cable to the connector at the back of the display panel and close the latch to secure the cable .
3. Adhere the tape that secures the display cable to the back of the display panel .
4. Turn the display panel over and place it on the display back-cover.
5. Lift the bottom side of the display panel and slide the top side into the slots at the top of the display back-cover.
6. Gently push down on the edges of the display panel until it clicks into the tabs on the display back-cover.

### Next steps

1. Install the [display bezel](#).
2. Install the [hinge caps](#).
3. Install the [display assembly](#).
4. Install the [WLAN card](#).
5. Install the [base cover](#).
6. Exit [service mode](#).
7. Install the [SD card](#).
8. Follow the procedure in [after working inside your computer](#).

## Camera

### Removing the camera

#### Prerequisites

1. Follow the procedure in [before working inside your computer](#).
2. Remove the [SD card](#).
3. Enter [service mode](#).
4. Remove the [base cover](#).
5. Remove the [WLAN card](#).
6. Remove the [display assembly](#).
7. Remove the [hinge caps](#).
8. Remove the [display bezel](#).
9. Remove the [display panel](#).

#### About this task

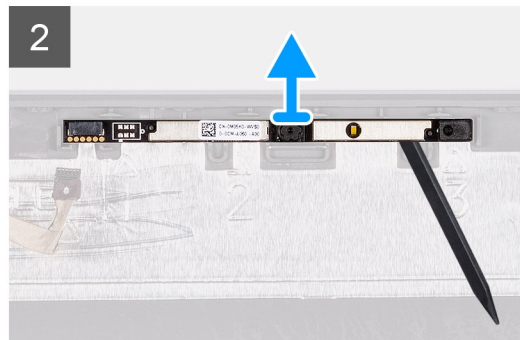
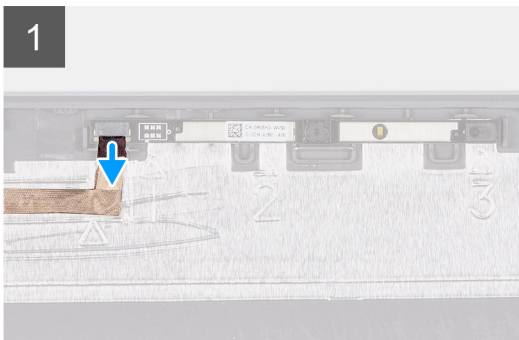
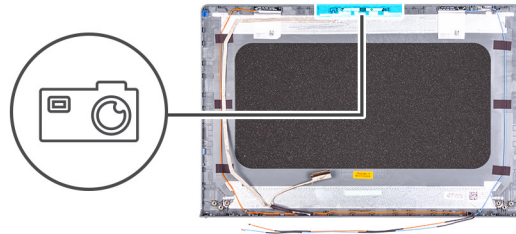

#### Steps

1. Disconnect the camera cable from the camera module.
2. Using a plastic scribe, gently pry the camera off the display back-cover and antenna assembly.



# Installing the camera

## Prerequisites

If you are replacing a component, remove the existing component before performing the installation procedure.

## About this task

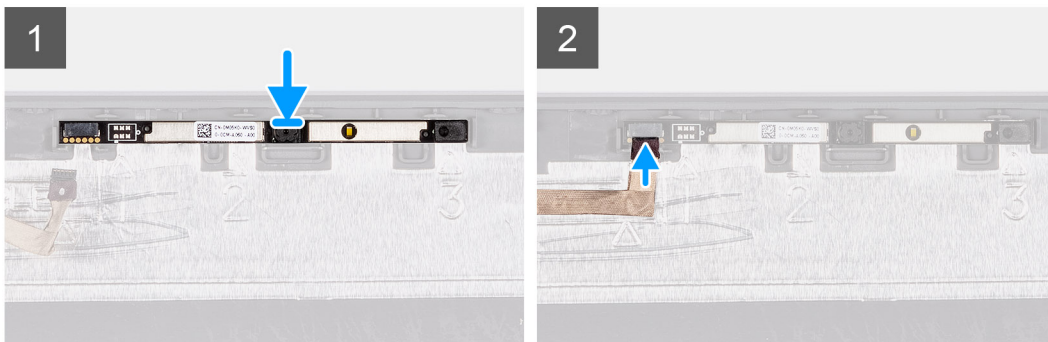
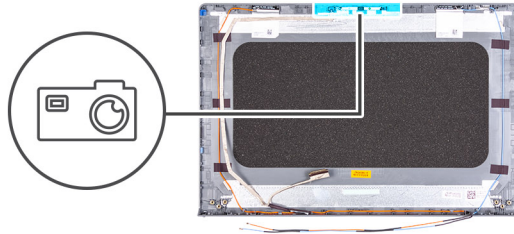

## Steps

1. Using the alignment post, adhere the camera module on the display back-cover and antenna assembly.
2. Connect the camera cable to the camera module.

## Next steps

1. Install the [display panel](#).
2. Install the [display bezel](#).
3. Install the [hinge caps](#).
4. Install the [display assembly](#).
5. Install the [WLAN card](#).
6. Install the [base cover](#).
7. Exit [service mode](#).
8. Install the [SD card](#).
9. Follow the procedure in [after working inside your computer](#).

# Display eDP cable

## Removing the eDP cable

### Prerequisites

1. Follow the procedure in [before working inside your computer](#).
2. Remove the [SD card](#).
3. Enter [service mode](#).
4. Remove the [base cover](#).
5. Remove the [WLAN card](#).
6. Remove the [display assembly](#).

7. Remove the [hinge caps](#).
8. Remove the [display bezel](#).
9. Remove the [display panel](#).

### About this task

The following images indicate the location of the eDP cable and provides a visual representation of the removal procedure.

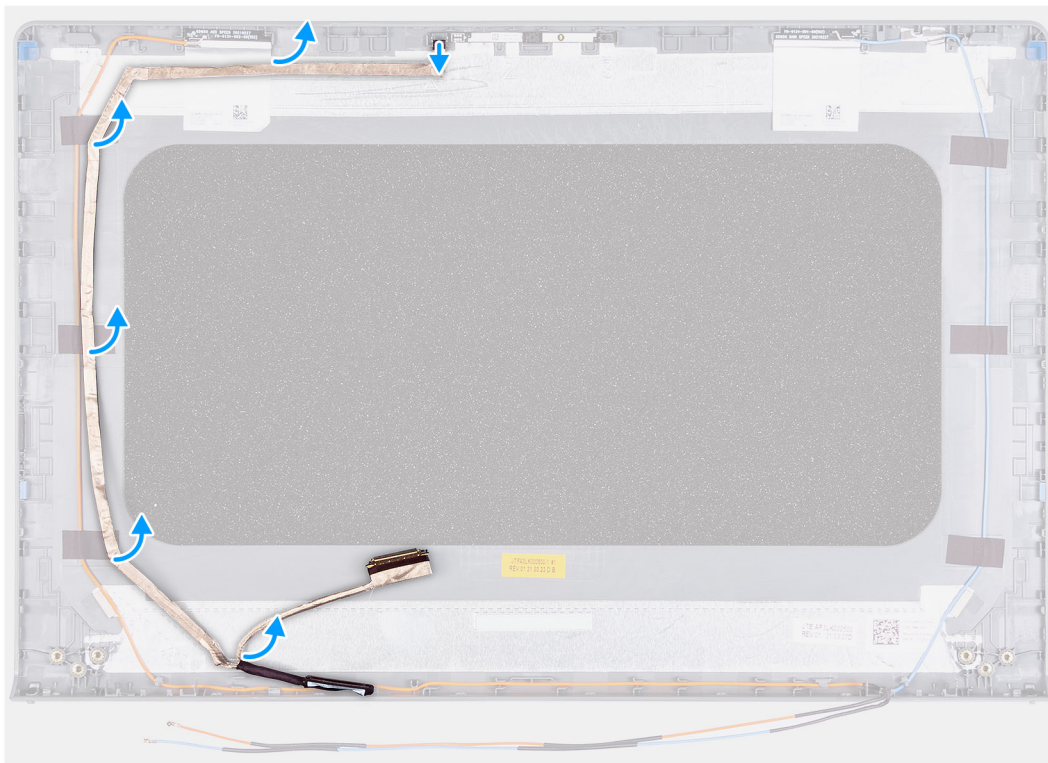

### Steps

1. Disconnect the eDP cable from the camera module.
2. Carefully peel the eDP cable from the display back-cover.

## Installing the eDP cable

### Prerequisites

If you are replacing a component, remove the existing component before performing the installation procedure.

### About this task

The following images indicate the location of the eDP cable and provides a visual representation of the installation procedure.

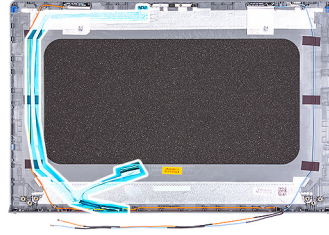

### Steps

1. Adhere the eDP cable to the display back cover.
2. Connect the eDP cable to the camera module.

### Next steps

1. Install the [display panel](#).
2. Install the [display bezel](#).
3. Install the [hinge caps](#).
4. Install the [display assembly](#).
5. Install the [WLAN card](#).
6. Install the [base cover](#).
7. Exit [service mode](#).
8. Install the [SD card](#).
9. Follow the procedure in [after working inside your computer](#).



# Display back-cover

## Removing the display back-cover

### Prerequisites

1. Follow the procedure in [before working inside your computer](#).
2. Remove the [SD card](#).
3. Enter [service mode](#).
4. Remove the [base cover](#).
5. Remove the [WLAN card](#).
6. Remove the [display assembly](#).
7. Remove the [hinge caps](#).
8. Remove the [display bezel](#).
9. Remove the [display panel](#).
10. Remove the [camera](#).

### About this task

The following images indicate the location of the display back-cover and provides a visual representation of the removal procedure.



### Steps

After performing all the preceding steps, you are left with the display back-cover.

## Installing the display back-cover

### About this task

The following images indicate the location of the display back-cover and provides a visual representation of the installation procedure.





### Steps

Place the display back-cover on a clean surface and perform the post-requisites to install the display back-cover.

### Next steps

1. Install the [camera](#).
2. Install the [display panel](#).
3. Install the [display bezel](#).
4. Install the [hinge caps](#).
5. Install the [display assembly](#).
6. Install the [WLAN card](#).
7. Install the [base cover](#).
8. Exit [service mode](#).
9. Install the [SD card](#).
10. Follow the procedure in [after working inside your computer](#).

## Power button

### Removing the power button

#### Prerequisites

1. Follow the procedure in [before working inside your computer](#).
2. Remove the [SD card](#).
3. Enter [service mode](#).
4. Remove the [base cover](#).
5. Remove the [IO board](#).

#### About this task

The following images indicate the location of the power button and provides a visual representation of the removal procedure.



1x  
M2x2

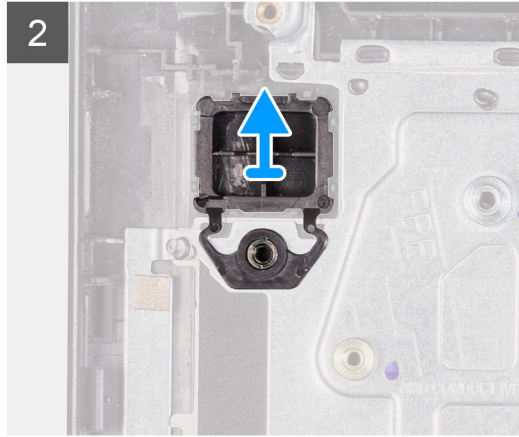
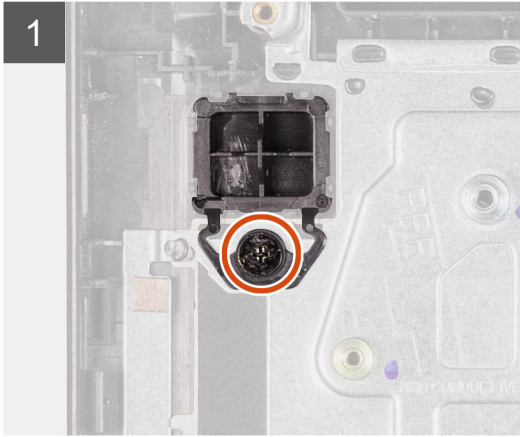
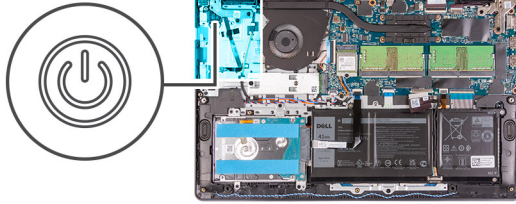

### Steps

1. Remove the single (M2x2) screws securing the power button to the palm-rest and keyboard assembly.
2. Remove the power button from the computer.

## Installing the power button

### Prerequisites

If you are replacing a component, remove the existing component before performing the installation procedure.

### About this task

The following images indicate the location of the power button and provides a visual representation of the installation procedure.



1x  
M2x2

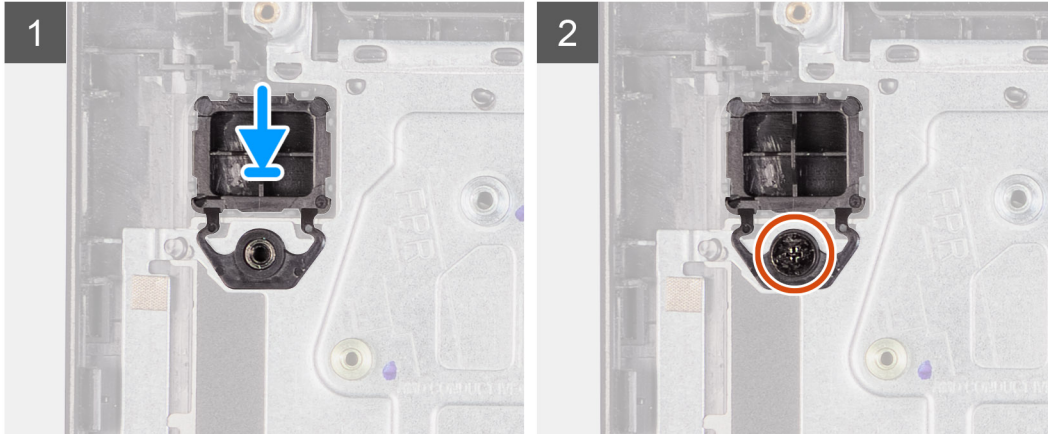
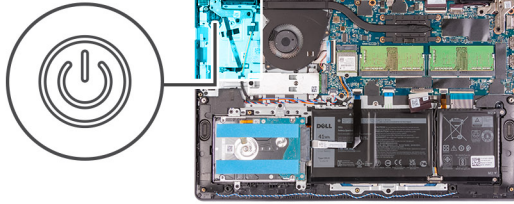

### Steps

1. Place the power-button board into the slot on the palm-rest and keyboard assembly.
2. Install the single (M2x2) screws to secure the power button to the palm-rest and keyboard assembly.

### Next steps

1. Install the [IO board](#).
2. Install the [base cover](#).
3. Exit [service mode](#).
4. Install the [SD card](#).
5. Follow the procedure in [after working inside your computer](#).

## Power button with fingerprint reader

### Removing the power-button with fingerprint reader

#### Prerequisites

1. Follow the procedure in [before working inside your computer](#).
2. Remove the [SD card](#).
3. Enter [service mode](#).
4. Remove the [base cover](#).
5. Remove the [IO board](#).

#### About this task

The following images indicate the location of the power-button with fingerprint reader and provides a visual representation of the removal procedure.

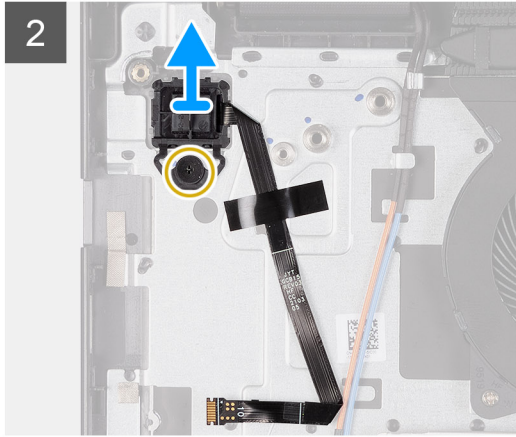
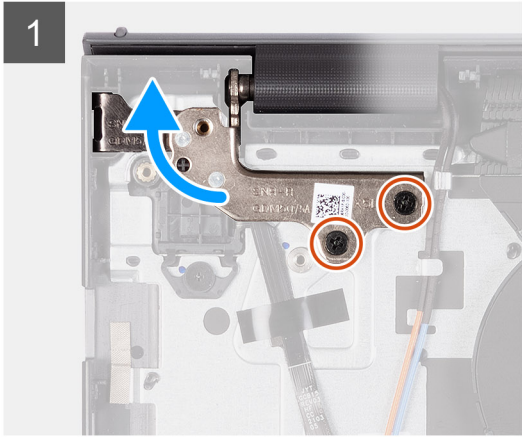
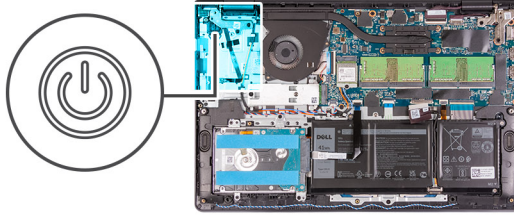

### Steps

1. Remove the two (M2.5x5) screws securing the left hinge to the palm-rest and keyboard assembly.
2. Fold back the hinge to access the power-button with fingerprint reader.
3. Remove the single (M2x3) screw securing the power-button with fingerprint reader to the palm-rest and keyboard assembly.
4. Peel back the tape holding the fingerprint-reader FFC to the palm-rest and keyboard assembly.
5. Remove the power-button with fingerprint reader and FFC from the computer.

## Installing the power-button with fingerprint reader

### Prerequisites

If you are replacing a component, remove the existing component before performing the installation procedure.

### About this task

The following images indicate the location of the power-button with fingerprint reader and provides a visual representation of the installation procedure.



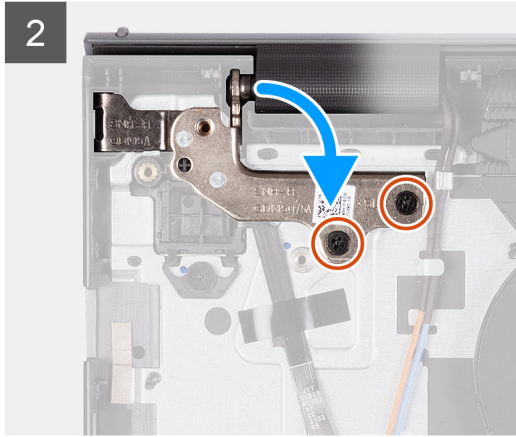
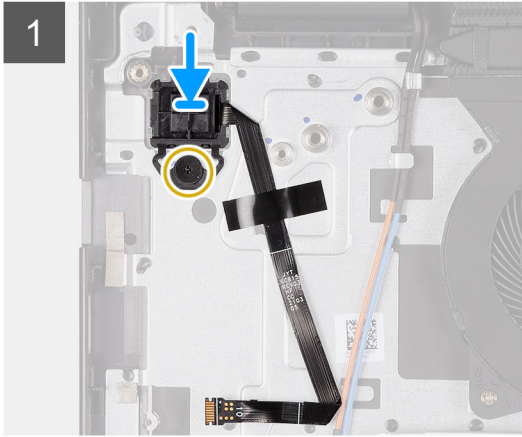
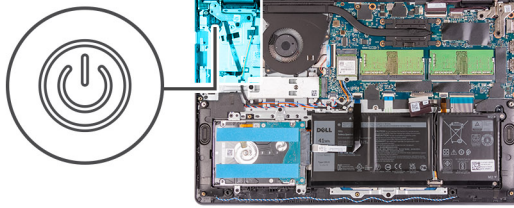

### Steps

1. Place the power-button with fingerprint reader into the slot on the palm-rest and keyboard assembly.
2. Install the single (M2x2) screws to secure the power-button with fingerprint reader to the palm-rest and keyboard assembly.

#### **i** NOTE:

For models shipped with a fingerprint reader, when installing the power-button, fold and align the fingerprint-reader FPC to the mark at the right of the power button. Then align the white line on the FPC to the mark on the palm rest.

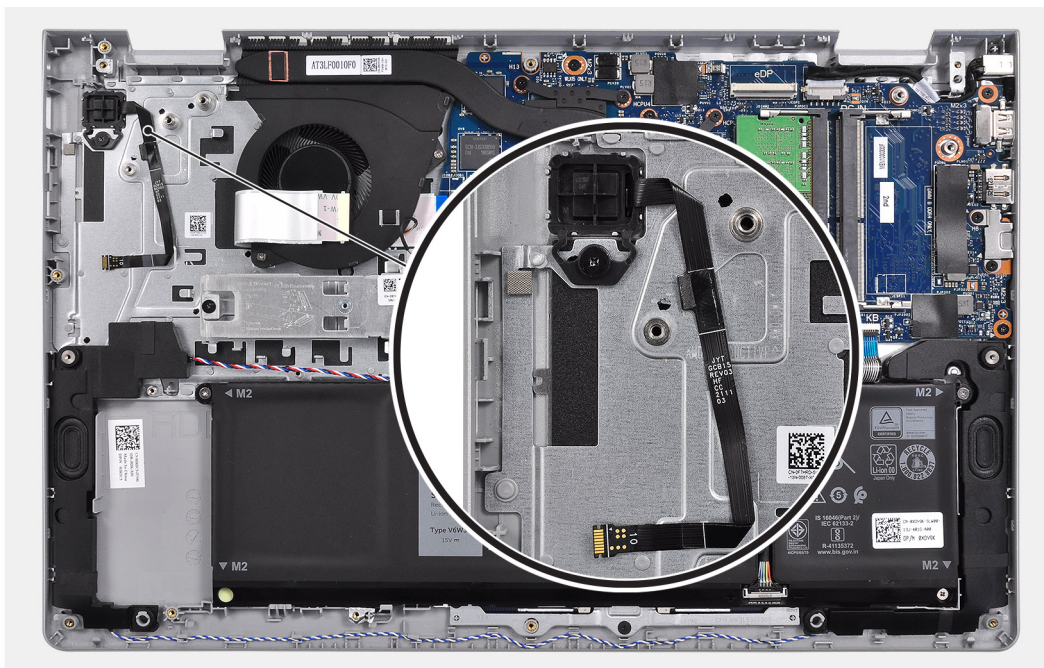

3. Re-adhere the tape to secure the fingerprint-reader FPC to the palm-rest and keyboard assembly.
4. Fold back the left hinge and install two single (M2.5x5) screws to secure the hinge to the palm-rest and keyboard assembly.

## Next steps

1. Install the [IO board](#).
2. Install the [base cover](#).
3. Exit [service mode](#).
4. Install the [SD card](#).
5. Follow the procedure in [after working inside your computer](#).

# System board

## System board connectors

The following image shows the different connectors on the system board.

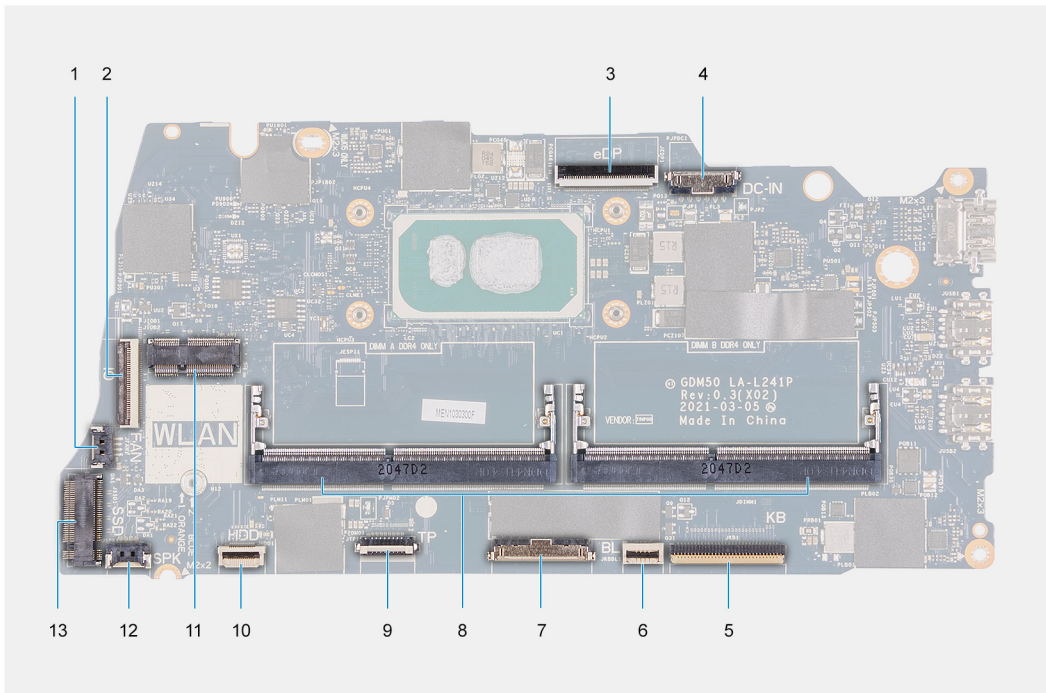

1. Fan connector
2. IO board FFC connector
3. eDP connector
4. DC-in port connector
5. Keyboard FFC connector
6. Backlit FFC connector
7. Battery connector
8. Memory module connectors
9. Touchpad FFC connector
10. Hard-drive FFC connector
11. WLAN connector
12. Speaker cable connector
13. SSD connector

## Removing the system board

### Prerequisites

1. Follow the procedure in [before working inside your computer](#).
2. Remove the [SD card](#).



3. Remove the [base cover](#).
  4. Remove the [battery](#).
  5. Remove the [WLAN card](#).
  6. Remove the [memory modules](#)
  7. Remove the [display assembly](#).
  8. Remove the [SSD](#).
  9. Remove the [system fan](#).
  10. Remove the [heatsink](#).
-  **NOTE:** The system board can be removed along with the heat sink.

**About this task**

The following images indicate the location of the system board and provides a visual representation of the removal procedure.

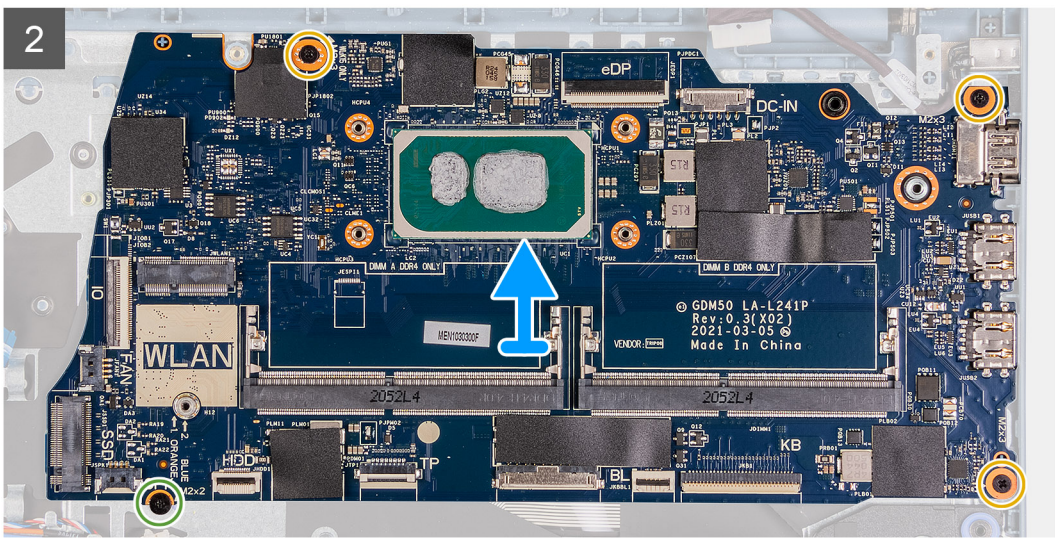
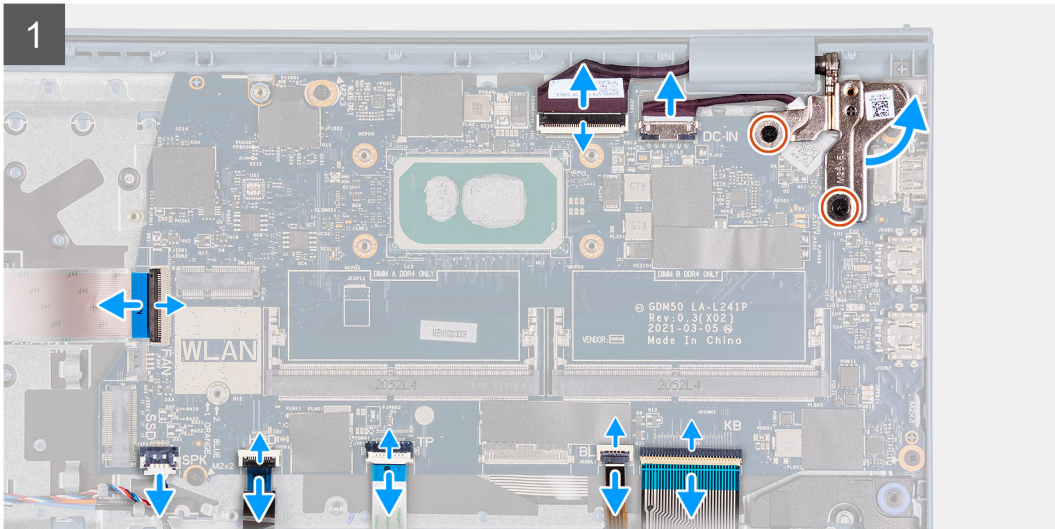
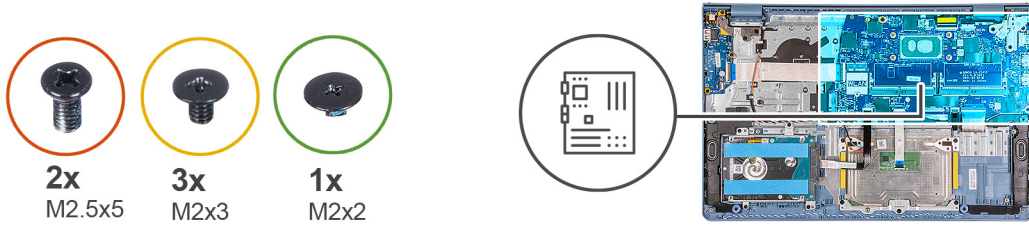

## Steps

1. Remove the two (M2.5x5) screws from the right hinge and fold the right hinge up.
2. Disconnect the following cables from the system board:
  - a. Fan cable
  - b. IO board FFC
  - c. Power- adapter port cable
  - d. Fingerprint-reader cable, if applicable
  - e. Keyboard FFC
  - f. Keyboard backlight FFC, if applicable
  - g. Touchpad FFC
  - h. Hard drive FFC
  - i. Speaker cable
3. Remove the three (M2x3) screws and the single (M2x2) screw that secures the system board to the palm-rest and keyboard assembly.
4. Carefully lift the system board away from the palm-rest and keyboard assembly.

## Installing the system board

### Prerequisites

If you are replacing a component, remove the existing component before performing the installation procedure.

### About this task

The following images indicate the location of the system board and provides a visual representation of the installation procedure.



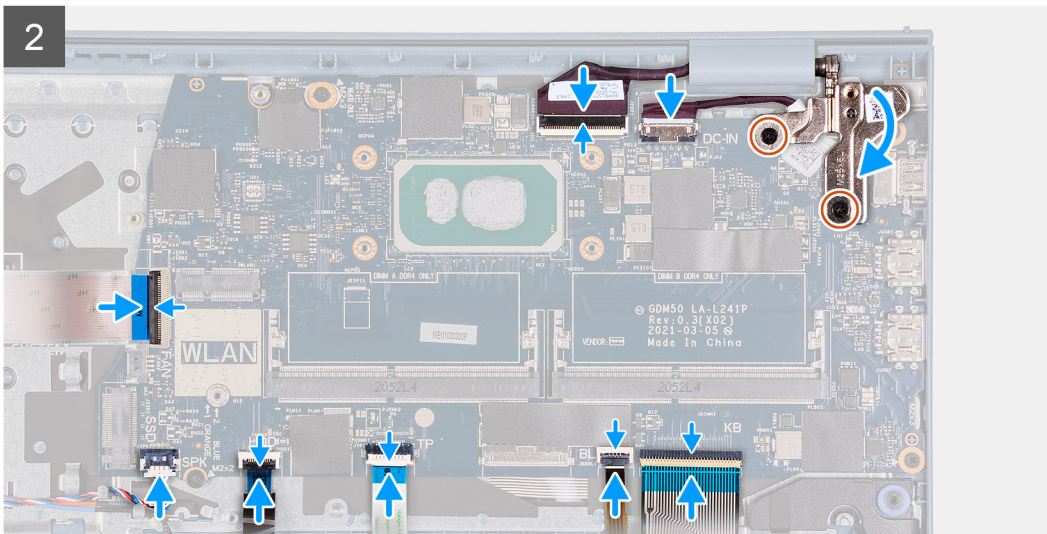
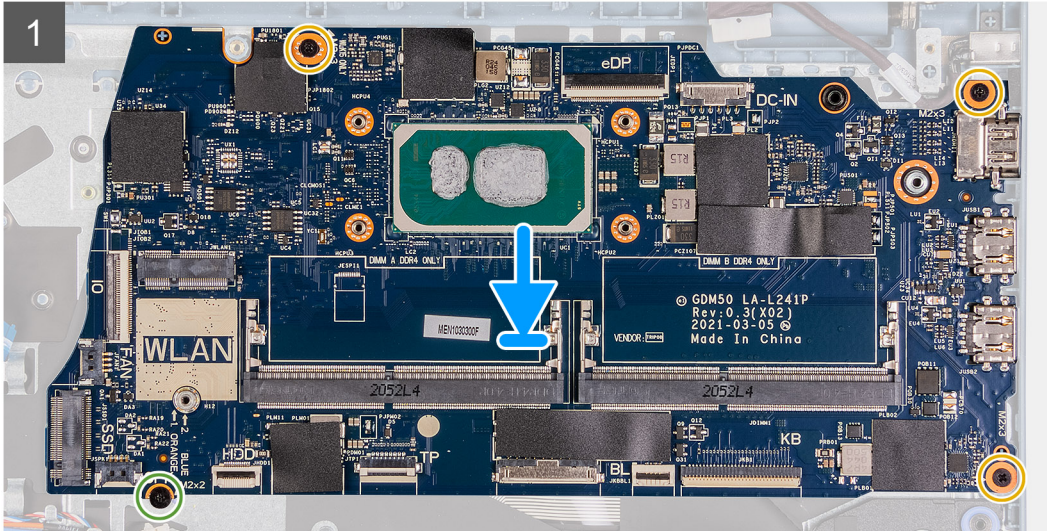
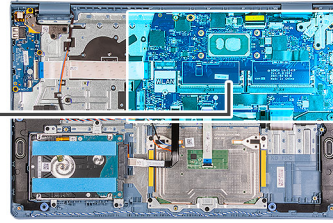

### Steps

1. Align and place the system board on the palm-rest and keyboard assembly.
2. Replace the single (M2x4) screw that secures the system board to the palm-rest and keyboard assembly.
3. Connect the following cables to the system board:
  - a. Fan cable
  - b. IO board FFC
  - c. Power-adaptor port cable
  - d. Fingerprint-reader cable, if applicable
  - e. Keyboard FFC
  - f. Keyboard backlight FFC, if applicable
  - g. Touchpad FFC
  - h. Hard drive FFC
  - i. Speaker cable



4. Fold back the right hinge and install the two (M2.5x5) screws to secure it to the palm-rest and keyboard assembly.

### Next steps

1. Install the [display assembly](#).
2. Install the [heatsink](#).
3. Install the [system fan](#).
4. Install the [memory modules](#).
5. Install the [SSD](#).
6. Install the [WLAN card](#).
7. Install the [battery](#).
8. Install the [base cover](#).
9. Install the [SD card](#).
10. Follow the procedure in [after working inside your computer](#).

## Power-adapter port

### Removing the power-adapter port

#### Prerequisites

1. Follow the procedure in [before working inside your computer](#).
2. Remove the [SD card](#).
3. Enter [service mode](#).
4. Remove the [base cover](#).

#### About this task

The following images indicate the location of the power-adapter port and provides a visual representation of the installation procedure.



2x  
M2.5x5

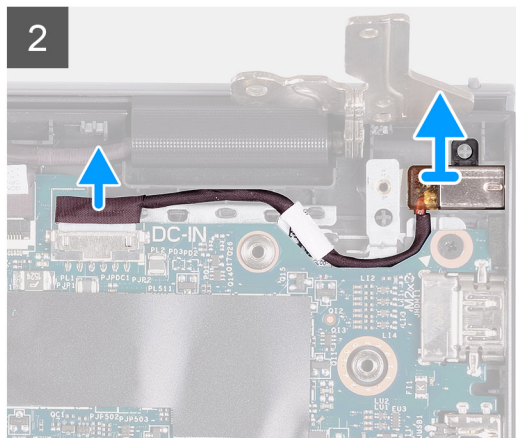
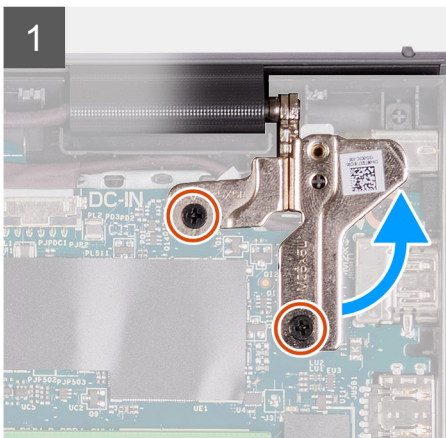
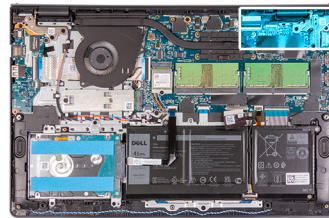

#### Steps

1. Remove the two (M2.5x5) screws from the right hinge and fold the hinge up.
2. Disconnect the power-adapter port cable from the system board.

3. Remove the power-adapter port module from the computer.

**NOTE:** The power-adapter port is secured in place only by the right display hinge. Ensure that the power-adapter port does not fall off from the slot after the right hinge is removed.

## Installing the power-adapter port

### Prerequisites

If you are replacing a component, remove the existing component before performing the installation procedure.

### About this task

The following images indicate the location of the power-adapter port and provides a visual representation of the installation procedure.



2x  
M2.5x5

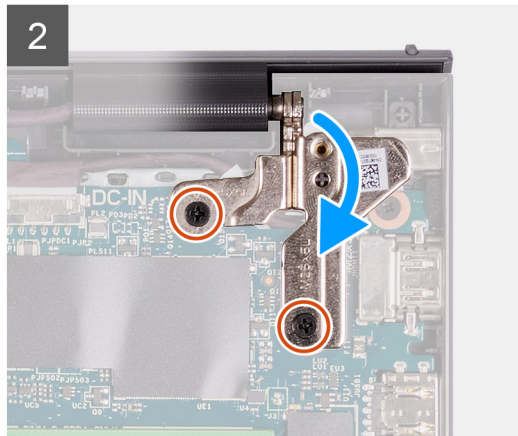
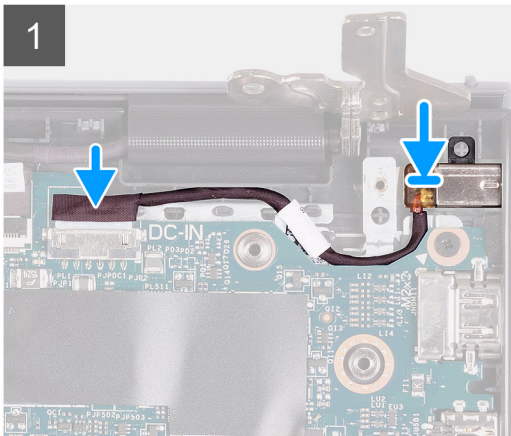
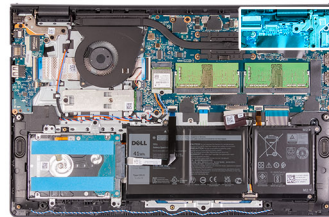

### Steps

1. Place the power adapter port module into the slot provided on the palmrest.
2. Connect the power adapter cable to the connector on the system board.
3. Fold the right hinge back down and install the two (M2.5x5) screws to secure it.

### Next steps

1. Install the [base cover](#).
2. Exit [service mode](#).
3. Install the [SD card](#).
4. Follow the procedure in [after working inside your computer](#).

# Palm-rest and keyboard assembly

## Removing the palm-rest and keyboard assembly

### Prerequisites

1. Follow the procedure in [before working inside your computer](#).
2. Remove the [SD card](#).
3. Remove the [base cover](#).
4. Remove the [battery](#).
5. Remove the [WLAN card](#).
6. Remove the [memory modules](#)
7. Remove the [display assembly](#).
8. Remove the [SSD](#).
9. Remove the [hard drive assembly](#).
10. Remove the [speakers](#).
11. Remove the [system fan](#).
12. Remove the [heatsink](#).

**i** **NOTE:** The system board can be removed along with the heat sink.

13. Remove the [IO board](#).
14. Remove the [touchpad](#).
15. Remove the [power adapter port](#).
16. Remove the [system board](#).

### About this task

The following images indicate the location of the palm-rest and keyboard assembly, and provides a visual representation of the installation procedure.

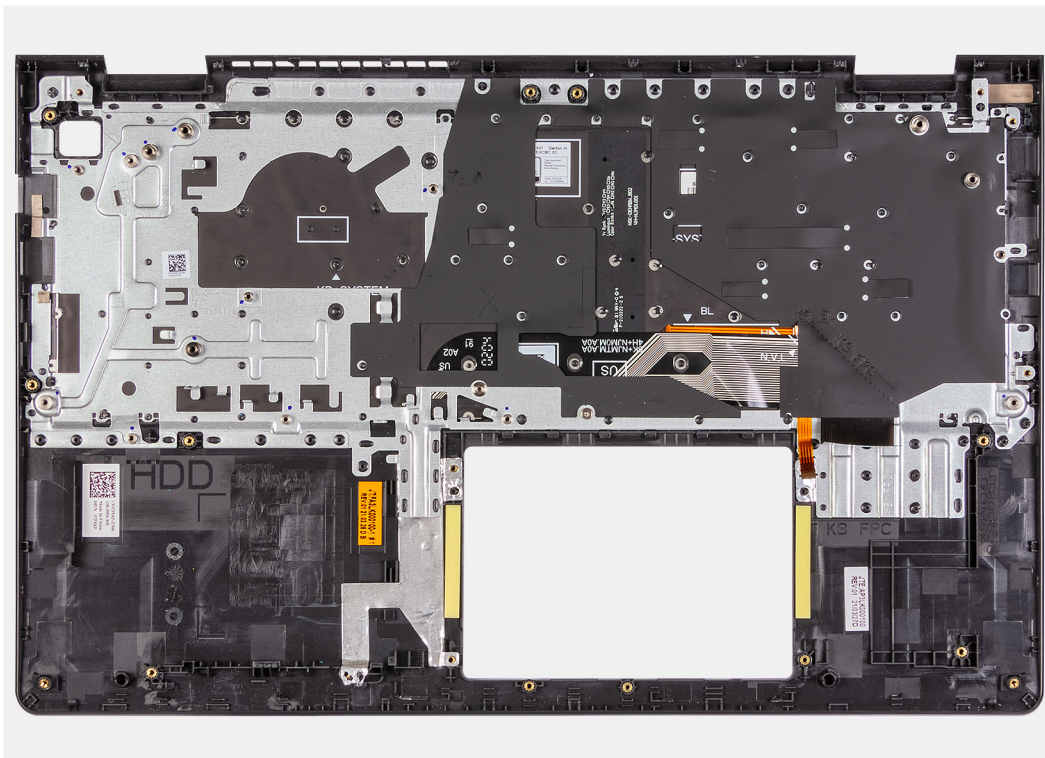

### Steps

After performing the preceding steps, you are left with the palmrest and keyboard assembly.

# Installing the palm-rest and keyboard assembly

## Prerequisites

If you are replacing a component, remove the existing component before performing the installation process.

## About this task

The following images indicate the location of the palm-rest and keyboard assembly and provides a visual representation of the installation procedure.

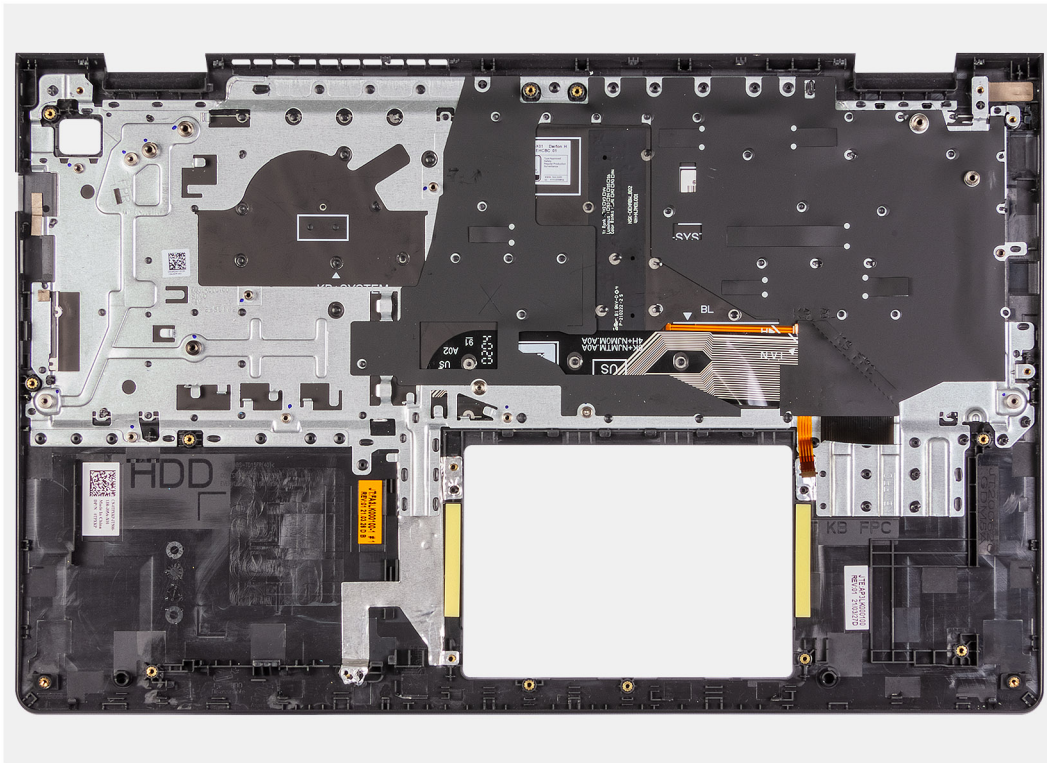

## Steps

Place the palm-rest and keyboard assembly on a flat and clean surface, and perform the post-requisites to install the palm-rest and keyboard assembly.

## Next steps

1. Install the [system board](#).
2. Install the [power adapter port](#).
3. Install the [touchpad](#).
4. Install the [IO board](#).
5. Install the [heatsink](#).
6. Install the [system fan](#).
7. Install the [speakers](#).
8. Install the [hard drive assembly](#).
9. Install the [SSD](#).
10. Install the [display assembly](#).
11. Install the [memory modules](#)
12. Install the [WLAN card](#).
13. Install the [battery](#).
14. Install the [base cover](#).
15. Install the [SD card](#).
16. Follow the procedure in [after working inside your computer](#).



## Drivers and downloads

When troubleshooting, downloading, or installing drivers, it is recommended that you read the Dell knowledge base article, [Drivers and Downloads FAQs](#) .



# System setup

**CAUTION:** Unless you are an expert computer user, do not change the settings in the BIOS Setup program. Certain changes can make your computer work incorrectly.

**NOTE:** Depending on the computer and its installed devices, the items listed in this section may or may not be displayed.

**NOTE:** Before you change BIOS Setup program, it is recommended that you write down the BIOS Setup program screen information for future reference.

Use the BIOS Setup program for the following purposes:

- Get information about the hardware installed in your computer, such as the amount of RAM and the size of the hard drive.
- Change the system configuration information.
- Set or change a user-selectable option, such as the user password, type of hard drive installed, and enabling or disabling base devices.

## Entering BIOS setup program

### About this task

Turn on (or restart) your computer and press F2 immediately.

## Navigation keys

**NOTE:** For most of the System Setup options, changes that you make are recorded but do not take effect until you restart the system.

**Table 3. Navigation keys**

Keys	Navigation
Up arrow	Moves to the previous field.
Down arrow	Moves to the next field.
Enter	Selects a value in the selected field (if applicable) or follow the link in the field.
Spacebar	Expands or collapses a drop-down list, if applicable.
Tab	Moves to the next focus area. <b>NOTE:</b> For the standard graphics browser only.
Esc	Moves to the previous page until you view the main screen. Pressing Esc in the main screen displays a message that prompts you to save any unsaved changes and restarts the system.

## BIOS overview

The BIOS manages data flow between the computer's operating system and attached devices such as hard disk, video adapter, keyboard, mouse, and printer.

# One time boot menu

To enter **one time boot menu**, turn on your computer, and then press F12 immediately.

**NOTE:** It is recommended to shutdown the computer if it is on.

The one-time boot menu displays the devices that you can boot from including the diagnostic option. The boot menu options are:

- Removable Drive (if available)
- STXXXX Drive (if available)

**NOTE:** XXX denotes the SATA drive number.

- Optical Drive (if available)
- SATA Hard Drive (if available)
- Diagnostics

The boot sequence screen also displays the option to access the System Setup screen.

## Boot Sequence

Boot Sequence allows you to bypass the System Setup–defined boot device order and boot directly to a specific device (for example: optical drive or hard drive). During the Power-on Self Test (POST), when the Dell logo appears, you can:

- Access System Setup by pressing F2 key
- Bring up the one-time boot menu by pressing F12 key

The one-time boot menu displays the devices that you can boot from including the diagnostic option. The boot menu options are:

- Removable Drive (if available)
- STXXXX Drive (if available)

**NOTE:** XXX denotes the SATA drive number.

- Optical Drive (if available)
- SATA Hard Drive (if available)
- Diagnostics

The boot sequence screen also displays the option to access the System Setup screen.

## System setup options

**NOTE:** Depending on the laptop and its installed devices, the items listed in this section may or may not appear.

### Boot menu

Press <F12> when the Dell logo appears to initiate a one-time boot menu with a list of the valid boot devices for the system. Diagnostics and BIOS Setup options are also included in this menu. The devices that are listed on the boot menu depend on the bootable devices in the system. This menu is useful when you are attempting to boot to a particular device or to bring up the diagnostics for the system. Using the boot menu does not make any changes to the boot order stored in the BIOS.

**Table 4. UEFI Boot options**

Options
Windows Boot Manager
UEFI hard drive

**Table 5. Other Options**

Options	Description
BIOS SETUP	Allows the user to configure the BIOS and control system functions
Diagnostics	Allows the user to run system tests to identify issues
BIOS Update	Allows the user to search and install the latest BIOS updates
SupportAssist OS Recovery	Used to analyze, repair, and restore the operating system on the system
BIOS Flash Update - Remote	
Device Configuration	

## Overview

This section provides hardware specification for the system and contains no modifiable settings.

**Table 6. BIOS Overview Page**

Options	Description
Series and system model number	<p>This field shows the following information:</p> <ul style="list-style-type: none"> <li>● BIOS Version - The version of the BIOS installed on the computer.</li> <li>● Service tag - The unique 7 digit hexadecimal identification number for the computer.</li> <li>● Asset tag</li> <li>● Manufacture Date - The date for when the unit was manufactured.</li> <li>● Ownership Date - The date for when the unit's ownership was transferred to the end user.</li> <li>● Express Service Code - An alternative to Service Tag, 11-digit numerical identification number for the computer.</li> <li>● Ownership Tag</li> <li>● Signed Firmware Update - This helps to verify that only Dell Signed and released BIOS can be installed on the computer.</li> </ul>
Battery	<p>The Battery field provides battery and adapter related information:</p> <ul style="list-style-type: none"> <li>● Primary battery - This helps identify if the system is running on the primary battery.</li> <li>● Battery level - This gives the percentage of battery backup remaining for the computer.</li> <li>● Battery state - This helps identify if the battery is in charging or active use state.</li> <li>● Health - This helps identify the health of the battery. It would show one of the following states based on the battery life remaining: <ul style="list-style-type: none"> <li>○ Excellent</li> <li>○ Good</li> <li>○ Fair</li> <li>○ Poor</li> </ul> </li> <li>● AC Adapter - This helps identify if the charger is plugged in and mentions the wattage of the charger connected.</li> </ul>

**Table 6. BIOS Overview Page (continued)**

Options	Description
Processor	<p>The Processor field provides information related to the CPU on the computer:</p> <ul style="list-style-type: none"> <li>● Processor Type - This field mentions the CPU model and generation information.</li> <li>● Maximum Clock Speed - This field mentions the maximum clock speed that the CPU is capable of reaching.</li> <li>● Minimum Clock Speed - This field mentions the minimum clock speed that the CPU is capable of reaching.</li> <li>● Current Clock Speed - This field mentions the clock speed that the CPU is running at currently.</li> <li>● Core Count - This field gives the count of the physical cores on the CPU.</li> <li>● Processor ID</li> <li>● Processor L3 Cache - This field shows the amount of cache storage available on the CPU.</li> <li>● Microcode Version</li> <li>● Intel Hyper-Threading Capable - This field helps identify if the CPU is capable of Hyper-Threading.</li> <li>● 64-bit Technology - This field helps identify the CPU architecture.</li> </ul>
Memory	<p>The Memory field provides information related to the memory on the computer:</p> <ul style="list-style-type: none"> <li>● Memory Installed - This field gives the amount of memory installed on the computer.</li> <li>● Memory Available - This field gives the amount of memory available for use on the computer.</li> <li>● Memory Speed - This field mentions the speed at which the memory runs on the computer.</li> <li>● Memory Channel Mode - This field helps us identify if the computer has Dual-Channel memory utilization capability.</li> <li>● DIMM_SLOT 1 - This field shows the capacity of the memory installed in the first DIMM slot.</li> <li>● DIMM_SLOT 2 - This field shows the capacity of the memory installed in the second DIMM slot.</li> </ul>
Devices	<p>The Devices field provides information related to the memory on the computer:</p> <ul style="list-style-type: none"> <li>● Panel Type - This field mentions the type of display panel used on the computer.</li> <li>● Video controller - This field mentions the type of video controller used on the computer.</li> <li>● Video Memory - This field gives the capacity of the video memory available for use on the computer.</li> <li>● Wi-Fi Device - This field mentions the type of wireless device available for use on the computer.</li> <li>● Native Resolution - This field mentions the native video resolution supported on the computer.</li> <li>● Video BIOS Version - The version of the BIOS installed on the computer.</li> <li>● Audio Controller - This field mentions the type of audio controller used on the computer.</li> <li>● Bluetooth Device - This field mentions the type of Bluetooth device available for use on the computer.</li> <li>● LOM MAC Address - This field provides the unique MAC address for the computer.</li> </ul>



**Table 6. BIOS Overview Page (continued)**

Options	Description
	<ul style="list-style-type: none"> <li>Pass Through MAC Address - This field provides the MAC address used to override the dock or dongle MAC address every time it's connected to the network.</li> </ul>

## Boot Configuration

This section provides Boot Configuration related details and settings.

**Table 7. Boot Configuration:**

Options	Description
Boot Sequence	
Boot Mode: UEFI only	<p>This section allows the user to choose the first bootable device that the computer should use to boot the system. It lists all potential bootable devices.</p> <ul style="list-style-type: none"> <li>Windows Boot Manager (Enabled by default)</li> <li>UEFI Boot Drive (Enabled by default)</li> <li>Add Boot option - Allows the user to manually add a Boot path.</li> </ul>
Secure Boot	
Enable Secure Boot	This section contains a toggle switch that allows the user to enable or disable Secure Boot. (OFF by default)
Secure Boot Mode	<p>This section allows the user to select one of the two Secure Boot options available on the computer:</p> <ul style="list-style-type: none"> <li>Deployed Mode - This mode checks the integrity of UEFI drivers and bootloaders before allowing execution. This option allows for full Secure Boot protections (Enabled by default.)</li> <li>Audit Mode - This mode performs a signature check but never does a block execution of all UEFI drivers and bootloaders. This mode is only used when making changes to Secure Boot Keys.</li> </ul>
Expert Key Management	
Enable Custom Mode	This section contains a toggle switch that allows the user to enable or disable Custom Mode. This mode allows the PK, KEK, db and dbx security key databases to be manipulated. (OFF by default)
Custom Mode Key Management	<p>This section helps the user to select the Key Database to allow modification. The options available are as below:</p> <ul style="list-style-type: none"> <li>PK (Selected by default)</li> <li>KEK</li> <li>db</li> <li>dbx</li> </ul>

## Integrated Devices

This section provides Integrated Devices details and settings.

**Table 8. Integrated Devices**

Options	Description
Date/Time	
Date	This section allows the user to change the date which takes effect immediately. The format used is MM/DD/YYYY
Time	This section allows the user to change the time which takes effect immediately. The format used is HH/MM/SS in 24 hour format. The user also has an option to switch between 12-hours or 24-hours clock.
Camera	
Enable Camera	This section contains a toggle switch that allows the user to enables/disable the internal webcam (Enabled by default).
Audio	
Enable Audio	This section contains a toggle switch that allows the user to enable or disable the audio on the computer. It also allows the user to: <ul style="list-style-type: none"> <li>• Enable Microphone (Enabled by default.)</li> <li>• Enable Internal Speakers (Enabled by default.)</li> </ul>
USB Configuration	This section helps the user to make changes to the USB settings on the computer. The options available are as follows: <ul style="list-style-type: none"> <li>• Enable USB Boot Support - Allows the system to boot from an external USB device (Enabled by default.)</li> <li>• Enable External USB Ports - Allows the user to enable or disable the USB ports on the computer (Enabled by default)</li> </ul>

## Storage

This section provides storage details and settings.

**Table 9. Storage**

Options	Description
SATA/NVMe Operation	
SATA/NVMe Operation	This section allows the user to select the operating mode of the integrated SATA hard drive controller. The following options are available: <ul style="list-style-type: none"> <li>• Disabled - SATA controllers are disabled.</li> <li>• AHCI - SATA is configured in AHCI mode.</li> <li>• RAID On - SATA is setup to support RAID (Intel Rapid Storage Technology). (Selected by default)</li> </ul>
Storage Interface	
Port Enablement	This section allows the user to enable or disable the onboard drives on the computer. The following options is available: <ul style="list-style-type: none"> <li>• M.2 PCIe SSD-0 (ON by default)</li> <li>• SATA-0 (ON by default)</li> </ul>
SMART Reporting	

**Table 9. Storage (continued)**

Options	Description
Enable SMART Reporting	This section contains a toggle switch that allows the user to enable or disable the S.M.A.R.T.(Self-Monitoring, Analysis, and Reporting Technology) option on the system (OFF by default).
Drive Information	This section provides information about the connected and active drives on the computer. The following options are available: <ul style="list-style-type: none"> <li>● M.2 PCIe SSD-0 <ul style="list-style-type: none"> <li>○ Type</li> <li>○ Device</li> </ul> </li> </ul>

## Display

This section provides display details and settings.

**Table 10. Display**

Options	Description
Display Brightness	
Brightness on battery power	This section has a scroll bar which allows the user to set the brightness level on battery power (lowest setting by default).
Brightness on AC power	This section has a scroll bar which allows the user to set the brightness level when system is connected to the AC adapter (highest setting by default).
EcoPower	This section contains a toggle switch which allows the user to enable/disable EcoPower feature that can increase the battery life by reducing the display brightness when appropriate.
Touchscreen (Optional)	
Touchscreen	This section contains a toggle switch which allows the user to enable/disable touch functionality on the system.

## Connection

This section provides connection details and settings.

**Table 11. Connection**

Options	Description
Wireless Device Enable	This section contains a toggle switch that allows the user to enable or disable WLAN and Bluetooth on the computer. The options are as follows: <ul style="list-style-type: none"> <li>● WLAN (Enabled by default).</li> <li>● Bluetooth (Enabled by default).</li> </ul>
Enable UEFI Network Stack	This section contains a toggle switch that allows the user to enable or disable installation of UEFI networking protocols. (ON by default)

**Table 11. Connection (continued)**

Options	Description
Wireless Radio Control	This section contains a toggle switch that allows the user to enable or disable a feature where the system will sense a connection to a wired network and disable the WLAN or WWAN connection (OFF by default).

## Security

**Table 12. Security**

Options	Description
Data Wipe on Next Boot	
Start Data Wipe	This section contains toggle switch which when enabled ensures that the BIOS will queue up a data wipe cycle for storage device(s) connected to the system board on the next reboot (OFF by default).

## Passwords

This section provides details on password settings.

**Table 13. Passwords**

Options	Description
Admin Password	This field allows the user to set, change, or delete the administrator password.
System Password	This field allows the user to set, change, or delete the system password.
NVMe SSD0	This field allows the user to set, change, or delete the storage drive password.

## Update Recovery

This section provides details on Update Recovery settings.

**Table 14. Update Recovery**

Options	Description
SupportAssist OS Recovery	
SupportAssist OS Recovery	This field contains a toggle switch which allows the user to enable or disable the boot flow for SupportAssist OS Recovery tool in the events of certain system errors (ON by default).
BIOSConnect	
BIOSConnect	This field contains a toggle switch which allows the user to enable or disable BIOSConnect setup to attempt cloud Service OS recovery if the main operating system fails to boot with a set number of failures (ON by default).
Dell Auto OS Recovery Threshold	



**Table 14. Update Recovery (continued)**

Options	Description
Dell Auto OS Recovery Threshold	This field allows the user to select the number of failed boot attempts by the system before SupportAssist OS Recovery is triggered. The options here are as below: <ul style="list-style-type: none"> <li>• Off</li> <li>• 1</li> <li>• 2 (selected by default)</li> <li>• 3</li> </ul>

## System Management

This section provides System Management settings.

**Table 15. System Management**

Options	Description
Service Tag	
Service Tag	This field provides the unique Service Tag of the computer.
Asset Tag	
Asset Tag	This field provides the asset tag which is a unique and up to 64-character identification that can be set by the IT administrator.

## Keyboard

This section provides keyboard settings.

**Table 16. Keyboard**

Options	Description
Numlock Enable	This field contains a toggle switch to enable Numlock function when the system boots (ON by default).
Fn Lock Options	
Fn Lock Options	This field contains a toggle switch to change the mode of the function keys (ON by default). The options are as follows: <ul style="list-style-type: none"> <li>• Lock Mode Standard - Traditional F1-F12 functions</li> <li>• Lock Mode Secondary - Enables secondary functions on the Fn keys (selected by default)</li> </ul>
Keyboard Illumination	
Keyboard Illumination	This field allows the user to set the keyboard illumination settings. The options available are as follows: <ul style="list-style-type: none"> <li>• Disabled - The keyboard illumination will be off</li> <li>• Dim - Enable the keyboard illumination feature at 50% brightness level</li> <li>• Bright - Enable the keyboard illumination feature at 100% brightness level (selected by default)</li> </ul>
Keyboard Backlight Timeout on AC	

**Table 16. Keyboard (continued)**

Options	Description
Keyboard Backlight Timeout on AC	<p>This field allows the user to define the timeout value for the backlight when the AC adapter is connected to the computer. The options here are as follows:</p> <ul style="list-style-type: none"> <li>● 5 seconds</li> <li>● 10 seconds (selected by default)</li> <li>● 15 seconds</li> <li>● 30 seconds</li> <li>● 1 minute</li> <li>● 5 minutes</li> <li>● 15 minutes</li> <li>● Never</li> </ul>
Keyboard Backlight Timeout on Battery	
Keyboard Backlight Timeout on Battery	<p>This field allows the user to define the timeout value for the backlight when the battery is powering to the computer. The options here are as follows:</p> <ul style="list-style-type: none"> <li>● 5 seconds</li> <li>● 10 seconds (selected by default)</li> <li>● 15 seconds</li> <li>● 30 seconds</li> <li>● 1 minute</li> <li>● 5 minutes</li> <li>● 15 minutes</li> <li>● Never</li> </ul>

## Pre-boot Behavior

This section provides Pre-boot Behavior details and settings.

**Table 17. Pre-boot Behavior**

Options	Description
Adapter Warnings	
Enable Adapter Warnings	<p>This field contains a toggle switch to enable or disable warning messages during boot when adapters with low power capacity are detected (enabled by default).</p>
Warning and Errors	
Warning and Errors	<p>This field allows the user to enable or disable boot process to be paused only when warnings or errors are detected. The options are as follows:</p> <ul style="list-style-type: none"> <li>● Prompt on Warnings and Errors - Stop, prompt and wait for user input when warnings or errors are detected (selected by default)</li> <li>● Continue on Warnings - Continue when warnings are detected but pause on errors</li> <li>● Continue on Warnings and Errors - Continue when either warnings or errors are detected during POST</li> </ul>

## System Logs

This section contains BIOS, Thermal and Power event logs.

**Table 18. System Logs**

Options	Description
BIOS Event Log	
Clear BIOS Event log	This field contains a toggle switch to Keep or Clear BIOS Event logs. It also lists all saved events(Date, Time, Message) - ("Keep" selected by default).
Thermal Event Log	
Clear Thermal Event Log	This field contains a toggle switch to Keep or Clear Thermal Event logs. It also lists all saved events(Date, Time, Message) - ("Keep" selected by default).
Power Event Log	
Clear Power Event Log	This field contains a toggle switch to Keep or Clear Power Event logs. It also lists all saved events(Date, Time, Message) - ("Keep" selected by default).

## Updating the BIOS

### Updating the BIOS in Windows

#### Steps

1. Go to [www.dell.com/support](http://www.dell.com/support).
2. Click **Product support**. In the **Search support** box, enter the Service Tag of your computer, and then click **Search**.  
 **NOTE:** If you do not have the Service Tag, use the SupportAssist feature to automatically identify your computer. You can also use the product ID or manually browse for your computer model.
3. Click **Drivers & Downloads**. Expand **Find drivers**.
4. Select the operating system installed on your computer.
5. In the **Category** drop-down list, select **BIOS**.
6. Select the latest version of BIOS, and click **Download** to download the BIOS file for your computer.
7. After the download is complete, browse the folder where you saved the BIOS update file.
8. Double-click the BIOS update file icon and follow the on-screen instructions.  
For more information, see knowledge base article [000124211](http://www.dell.com/support) at [www.dell.com/support](http://www.dell.com/support).

### Updating the BIOS using the USB drive in Windows

#### Steps

1. Follow the procedure from step 1 to step 6 in [Updating the BIOS in Windows](#) to download the latest BIOS setup program file.
2. Create a bootable USB drive. For more information, see the knowledge base article [000145519](http://www.dell.com/support) at [www.dell.com/support](http://www.dell.com/support).
3. Copy the BIOS setup program file to the bootable USB drive.
4. Connect the bootable USB drive to the computer that needs the BIOS update.
5. Restart the computer and press **F12** .
6. Select the USB drive from the **One Time Boot Menu**.
7. Type the BIOS setup program filename and press **Enter**.  
The **BIOS Update Utility** appears.
8. Follow the on-screen instructions to complete the BIOS update.

# Flashing the BIOS from the F12 One-Time boot menu

Update your computer BIOS using the BIOS update.exe file that is copied to a FAT32 USB drive and booting from the F12 One-Time boot menu.

## About this task

### BIOS Update

You can run the BIOS update file from Windows using a bootable USB drive or you can also update the BIOS from the F12 One-Time boot menu on the computer.

Most of the Dell computers built after 2012 have this capability, and you can confirm by booting your computer to the F12 One-Time Boot Menu to see if BIOS FLASH UPDATE is listed as a boot option for your computer. If the option is listed, then the BIOS supports this BIOS update option.

 **NOTE:** Only computers with BIOS Flash Update option in the F12 One-Time boot menu can use this function.

### Updating from the One-Time boot menu

To update your BIOS from the F12 One-Time boot menu, you need the following:

- USB drive formatted to the FAT32 file system (key does not have to be bootable)
- BIOS executable file that you downloaded from the Dell Support website and copied to the root of the USB drive
- AC power adapter that is connected to the computer
- Functional computer battery to flash the BIOS

Perform the following steps to perform the BIOS update flash process from the F12 menu:

 **CAUTION:** Do not turn off the computer during the BIOS update process. The computer may not boot if you turn off your computer.

### Steps

1. From a turn off state, insert the USB drive where you copied the flash into a USB port of the computer.
2. Turn on the computer and press F12 to access the One-Time Boot Menu, select BIOS Update using the mouse or arrow keys then press Enter.  
The flash BIOS menu is displayed.
3. Click **Flash from file**.
4. Select external USB device.
5. Select the file and double-click the flash target file, and then click **Submit**.
6. Click **Update BIOS**. The computer restarts to flash the BIOS.
7. The computer will restart after the BIOS update is completed.

# Updating BIOS on systems with BitLocker enabled

 **CAUTION:** If BitLocker is not suspended before updating the BIOS, the next time you reboot the system it will not recognize the BitLocker key. You will then be prompted to enter the recovery key to progress and the system will ask for this on each reboot. If the recovery key is not known this can result in data loss or an unnecessary operating system re-install. For more information on this subject, see Knowledge Article: <https://www.dell.com/support/article/sln153694>

# System and setup password

Table 19. System and setup password

Password type	Description
System password	Password that you must enter to log in to your system.

**Table 19. System and setup password (continued)**

Password type	Description
Setup password	Password that you must enter to access and make changes to the BIOS settings of your computer.

You can create a system password and a setup password to secure your computer.

 **CAUTION:** The password features provide a basic level of security for the data on your computer.

 **CAUTION:** Anyone can access the data that is stored on your computer if it is not locked and left unattended.

 **NOTE:** System and setup password feature is disabled.

## Assigning a system setup password

### Prerequisites

You can assign a new **System or Admin Password** only when the status is in **Not Set**.

### About this task

To enter the system setup, press F12 immediately after a power-on or reboot.

### Steps

1. In the **System BIOS** or **System Setup** screen, select **Security** and press Enter.  
The **Security** screen is displayed.
2. Select **System/Admin Password** and create a password in the **Enter the new password** field.  
Use the following guidelines to assign the system password:
  - A password can have up to 32 characters.
  - The password can contain the numbers 0 through 9.
  - Only lower case letters are valid, upper case letters are not valid.
  - Only the following special characters are valid: Space, ("), (+), (.), (-), (.), (/), (:), ([), (\), (]), (`).
3. Type the system password that you entered earlier in the **Confirm new password** field and click **OK**.
4. Press Esc and a message prompts you to save the changes.
5. Press Y to save the changes.  
The computer restarts.

## Deleting or changing an existing system setup password

### Prerequisites

Ensure that the **Password Status** is Unlocked (in the System Setup) before attempting to delete or change the existing System and/or Setup password. You cannot delete or change an existing System or Setup password, if the **Password Status** is Locked.

### About this task

To enter the System Setup, press F12 immediately after a power-on or reboot.

### Steps

1. In the **System BIOS** or **System Setup** screen, select **System Security** and press Enter.  
The **System Security** screen is displayed.
2. In the **System Security** screen, verify that **Password Status** is **Unlocked**.
3. Select **System Password**, update, or delete the existing system password, and press Enter or Tab.
4. Select **Setup Password**, update, or delete the existing setup password, and press Enter or Tab.



 **NOTE:** If you change the System and/or Setup password, reenter the new password when prompted. If you delete the System and/or Setup password, confirm the deletion when prompted.

5. Press Esc and a message prompts you to save the changes.
6. Press Y to save the changes and exit from System Setup.  
The computer restarts.

## Clearing BIOS (System Setup) and System passwords

### About this task

To clear the system or BIOS passwords, contact Dell technical support as described at [www.dell.com/contactdell](http://www.dell.com/contactdell).

 **NOTE:** For information on how to reset Windows or application passwords, refer to the documentation accompanying Windows or your application.

# Troubleshooting

## Handling swollen Lithium-ion batteries

Like most laptops, Dell laptops use lithium-ion batteries. One type of lithium-ion battery is the lithium-ion polymer battery. Lithium-ion polymer batteries have increased in popularity in recent years and have become standard in the electronics industry due to customer preferences for a slim form factor (especially with newer ultra-thin laptops) and long battery life. Inherent to lithium-ion polymer battery technology is the potential for swelling of the battery cells.

Swollen battery may impact the performance of the laptop. To prevent possible further damage to the device enclosure or internal components leading to malfunction, discontinue the use of the laptop and discharge it by disconnecting the AC adapter and letting the battery drain.

Swollen batteries should not be used and should be replaced and disposed of properly. We recommend contacting Dell product support for options to replace a swollen battery under the terms of the applicable warranty or service contract, including options for replacement by a Dell authorized service technician.

The guidelines for handling and replacing Lithium-ion batteries are as follows:

- Exercise caution when handling Lithium-ion batteries.
- Discharge the battery before removing it from the system.

To discharge the battery, unplug the AC adapter from the system and operate the system only on battery power. When the system will no longer power on when the power button is pressed, the battery is fully discharged.

- Do not crush, drop, mutilate, or penetrate the battery with foreign objects.
- Do not expose the battery to high temperatures, or disassemble battery packs and cells.
- Do not apply pressure to the surface of the battery.
- Do not bend the battery.
- Do not use tools of any type to pry on or against the battery.
- If a battery gets stuck in a device as a result of swelling, do not try to free it as puncturing, bending, or crushing a battery can be dangerous.
- Do not attempt to reassemble a damaged or swollen battery into a laptop.
- Swollen batteries should be returned to Dell in an approved shipping container (provided by Dell), to comply with transportation regulations or disposed at an approved recycling center.

Contact Dell product support at <https://www.dell.com/support> for assistance and further instructions.

- Using a non-Dell or incompatible battery may increase the risk of fire or explosion. Replace the battery only with a compatible battery purchased from Dell that is designed to work with your Dell computer. Do not use a battery from other computers with your computer. Always purchase genuine batteries from <https://www.dell.com> or otherwise directly from Dell.

Lithium-ion batteries can swell for various reasons such as age, number of charge cycles, or exposure to high heat. For more information on how to improve the performance and lifespan of the laptop battery and to minimize the possibility of occurrence of the issue, see [Dell Laptop Battery - Frequently Asked Questions](#).

## Dell SupportAssist Pre-boot System Performance Check diagnostics

### About this task

SupportAssist diagnostics (also known as system diagnostics) performs a complete check of your hardware. The Dell SupportAssist Pre-boot System Performance Check diagnostics is embedded with the BIOS and is launched by the BIOS internally. The embedded system diagnostics provides a set of options for particular devices or device groups allowing you to:

- Run tests automatically or in an interactive mode
- Repeat tests

- Display or save test results
- Run thorough tests to introduce additional test options to provide extra information about the failed device(s)
- View status messages that inform you if tests are completed successfully
- View error messages that inform you of problems encountered during testing

**NOTE:** Some tests for specific devices require user interaction. Always ensure that you are present at the computer terminal when the diagnostic tests are performed.

For more information, see <https://www.dell.com/support/kbdoc/000180971>.

## Running the SupportAssist Pre-Boot System Performance Check

### Steps

1. Turn on your computer.
2. As the computer boots, press the F12 key as the Dell logo appears.
3. On the boot menu screen, select the **Diagnostics** option.
4. Click the arrow at the bottom left corner.  
Diagnostics front page is displayed.
5. Click the arrow in the lower-right corner to go to the page listing.  
The items detected are listed.
6. To run a diagnostic test on a specific device, press Esc and click **Yes** to stop the diagnostic test.
7. Select the device from the left pane and click **Run Tests**.
8. If there are any issues, error codes are displayed.  
Note the error code and validation number and contact Dell.

## Built-in self-test (BIST)

### M-BIST

M-BIST (Built In Self-Test) is the system board's built-in self-test diagnostics tool that improves the diagnostics accuracy of system board embedded controller (EC) failures.

**NOTE:** M-BIST can be manually initiated before POST (Power On Self Test).

### How to run M-BIST

**NOTE:** M-BIST must be initiated on the system from a power-off state either connected to AC power or with battery only.

1. Press and hold both the **M** key on the keyboard and the **power button** to initiate M-BIST.
2. With both the **M** key and the **power button** held down, the battery indicator LED may exhibit two states:
  - a. OFF: No fault detected with the system board
  - b. AMBER: Indicates a problem with the system board
3. If there is a failure with the system board, the battery status LED will flash one of the following error codes for 30 seconds:

**Table 20. LED error codes**

Blinking Pattern		Possible Problem
Amber	White	
2	1	CPU Failure
2	8	LCD Power Rail Failure
1	1	TPM Detection Failure
2	4	Unrecoverable SPI Failure

4. If there is no failure with the system board, the LCD will cycle through the solid color screens described in the LCD-BIST section for 30 seconds and then power off.

## LCD Power rail test (L-BIST)

L-BIST is an enhancement to the single LED error code diagnostics and is automatically initiated during POST. L-BIST will check the LCD power rail. If there is no power being supplied to the LCD (i.e., the L-BIST circuit fails), the battery status LED will flash either an error code [2,8] or an error code [2,7].

 **NOTE:** If L-BIST fails, LCD-BIST cannot function as no power will be supplied to the LCD.

### How to invoke L-BIST Test:

1. Press the power button to start the system.
2. If the system does not start up normally, look at the battery status LED:
  - If the battery status LED flashes an error code [2,7], the display cable may not be connected properly.
  - If the battery status LED flashes an error code [2,8], there is a failure on the LCD power rail of the system board, hence there is no power supplied to the LCD.
3. For cases, when a [2,7] error code is shown, check to see if the display cable is properly connected.
4. For cases when a [2,8] error code is shown, replace the system board.

## LCD Built-in Self Test (BIST)

Dell laptops have a built-in diagnostic tool that helps you determine if the screen abnormality you are experiencing is an inherent problem with the LCD (screen) of the Dell laptop or with the video card (GPU) and PC settings.

When you notice screen abnormalities like flickering, distortion, clarity issues, fuzzy or blurry image, horizontal or vertical lines, color fade etc., it is always a good practice to isolate the LCD (screen) by running the Built-In Self Test (BIST).

### How to invoke LCD BIST Test

1. Power off the Dell laptop.
2. Disconnect any peripherals that are connected to the laptop. Connect only the AC adapter (charger) to the laptop.
3. Ensure that the LCD (screen) is clean (no dust particles on the surface of the screen).
4. Press and hold **D** key and **Power on** the laptop to enter LCD built-in self test (BIST) mode. Continue to hold the D key, until the system boots up.
5. The screen will display solid colors and change colors on the entire screen to white, black, red, green, and blue twice.
6. Then it will display the colors white, black and red.
7. Carefully inspect the screen for abnormalities (any lines, fuzzy color or distortion on the screen).
8. At the end of the last solid color (red), the system will shut down.

 **NOTE:** Dell SupportAssist Pre-boot diagnostics upon launch, initiates an LCD BIST first, expecting a user intervention confirm functionality of the LCD.

## System diagnostic lights

### Power and battery-status light

Indicates the power and battery-charge status.

**Solid white**—Power adapter is connected and the battery has more than 5% charge.

**Amber**—Computer is running on battery and the battery has less than 5% charge.

### Off

- Power adapter is connected, and the battery is fully charged.
- Computer is running on battery, and the battery has more than 5% charge.
- Computer is in sleep state, hibernation, or turned off.

The power and battery-status light blinks amber along with beep codes indicating failures.

For example, the power and battery-status light blinks amber two times followed by a pause, and then blinks white three times followed by a pause. This 2,3 pattern continues until the computer is turned off indicating no memory or RAM is detected.

The following table shows different power and battery-status light patterns and associated problems.

**Table 21. LED codes**

<b>Diagnostic light codes</b>	<b>Problem description</b>	<b>Recommended solutions</b>
<b>1,1</b>	TPM detection failure	Replace the system board.
<b>1,3</b>	Short in hinge cable tripped OCP1	Check if the display cable (EDP) is seated properly or pinched at the hinges. If problem persists, replace either display cable (EDP) or display assembly (LCD).
<b>1,4</b>	Short in hinge cable tripped OCP2	Check if the display cable (EDP) is seated properly or pinched at the hinges. If problem persists, replace either display cable (EDP) or display assembly (LCD).
<b>2,1</b>	Processor failure	Run the Intel CPU diagnostics tools. If problem persists, replace the system board.
<b>2,2</b>	System board: BIOS or ROM (Read-Only Memory) failure	Flash latest BIOS version. If problem persists, replace the system board.
<b>2,3</b>	No memory or RAM (Random-Access Memory) detected	Confirm that the memory module is installed properly. If problem persists, replace the memory module.
<b>2,4</b>	Memory or RAM (Random-Access Memory) failure	Reset and swap memory modules amongst the slots. If problem persists, replace the memory module.
<b>2,5</b>	Invalid memory installed	Reset and swap memory modules among the slots. If problem persists, replace the memory module.
<b>2,6</b>	System-board or chipset error	Flash latest BIOS version. If problem persists, replace the system board.
<b>2,7</b>	LCD failure - SBIOS message	Replace display cable (EDP) if possible, otherwise replace the display assembly (LCD).
<b>2,8</b>	LCD failure - EC detection of power rail failure	Replace the system board.
<b>3,1</b>	Coin-cell battery failure	Reset the CMOS battery connection. If problem persists, replace the RTC battery.
<b>3,2</b>	PCI, video card/chip failure	Replace the system board.
<b>3,3</b>	Recovery image not found	Flash latest BIOS version. If problem persists, replace the system board.
<b>3,4</b>	Recovery image found but invalid	Flash latest BIOS version. If problem persists, replace the system board.
<b>3,5</b>	Power-rail failure	EC ran into power sequencing failure. If problem persists, replace the system board.
<b>3,6</b>	System BIOS Flash incomplete	Flash corruption detected by SBIOS. If problem persists, replace the system board.
<b>3,7</b>	Management Engine (ME) error	Timeout waiting on ME to reply to HECI message. If problem persists, replace the system board.
<b>4,1</b>	Memory DIMM power rail failure	Replace the system board.

**Camera status light:** Indicates whether the camera is in use.



- Solid white—Camera is in use.
- Off—Camera is not in use.

**Caps Lock status light:** Indicates whether Caps Lock is enabled or disabled.

- Solid white—Caps Lock enabled.
- Off—Caps Lock disabled.

## Recovering the operating system

When your computer is unable to boot to the operating system even after repeated attempts, it automatically starts Dell SupportAssist OS Recovery.

Dell SupportAssist OS Recovery is a standalone tool that is preinstalled in all Dell computers installed with Windows 10 operating system. It consists of tools to diagnose and troubleshoot issues that may occur before your computer boots to the operating system. It enables you to diagnose hardware issues, repair your computer, back up your files, or restore your computer to its factory state.

You can also download it from the Dell Support website to troubleshoot and fix your computer when it fails to boot into their primary operating system due to software or hardware failures.

For more information about the Dell SupportAssist OS Recovery, see *Dell SupportAssist OS Recovery User's Guide* at [www.dell.com/support](http://www.dell.com/support).

## Real Time Clock—RTC reset

The Real Time Clock (RTC) reset function allows you or the service technician to recover the recently launched model Dell Latitude and Precision systems from **No POST/No Boot/No Power** situations. You can initiate the RTC reset on the system from a power-off state only if it is connected to AC power. Press and hold the power button for 25 seconds. The system RTC reset occurs after you release the power button.

**i** **NOTE:** If AC power is disconnected from the system during the process or the power button is held longer than 40 seconds, the RTC reset process gets aborted.

The RTC reset will reset the BIOS to Defaults, un-provision Intel vPro and reset the system date and time. The following items are unaffected by the RTC reset:

- Service Tag
- Asset Tag
- Ownership Tag
- Admin Password
- System Password
- HDD Password
- Key Databases
- System Logs

**i** **NOTE:** The IT administrator's vPro account and password on the system will be un-provisioned. The system needs to go through the setup and configuration process again to reconnect it to the vPro server.

The below items may or may not reset based on your custom BIOS setting selections:

- Boot List
- Enable Legacy Option ROMs
- Secure Boot Enable
- Allow BIOS Downgrade

## Backup media and recovery options

It is recommended to create a recovery drive to troubleshoot and fix problems that may occur with Windows. Dell proposes multiple options for recovering Windows operating system on your Dell PC. For more information, see [Dell Windows Backup Media and Recovery Options](#).

# WiFi power cycle

## About this task

If your computer is unable to access the internet due to WiFi connectivity issues a WiFi power cycle procedure may be performed. The following procedure provides the instructions on how to conduct a WiFi power cycle:

 **NOTE:** Some ISPs (Internet Service Providers) provide a modem/router combo device.

## Steps

1. Turn off your computer.
2. Turn off the modem.
3. Turn off the wireless router.
4. Wait for 30 seconds.
5. Turn on the wireless router.
6. Turn on the modem.
7. Turn on your computer.

# Drain residual flea power (perform hard reset)

## About this task

Flea power is the residual static electricity that remains in the computer even after it has been powered off and the battery is removed.

For your safety, and to protect the sensitive electronic components in your computer, you are requested to drain residual flea power before removing or replacing any components in your computer.

Draining residual flea power, also known as a performing a "hard reset", is also a common troubleshooting step if your computer does not power on or boot into the operating system.

## To drain residual flea power (perform a hard reset)

## Steps

1. Turn off your computer.
2. Disconnect the power adapter from your computer.
3. Remove the base cover.
4. Remove the battery.
5. Press and hold the power button for 20 seconds to drain the flea power.
6. Install the battery.
7. Install the base cover.
8. Connect the power adapter to your computer.
9. Turn on your computer.



 **NOTE:** For more information about performing a hard reset, see the knowledge base article [SLN85632](https://www.dell.com/support) at [www.dell.com/support](https://www.dell.com/support).

# Getting help and contacting Dell

## Self-help resources

You can get information and help on Dell products and services using these self-help resources:

**Table 22. Self-help resources**

Self-help resources	Resource location
Information about Dell products and services	<a href="http://www.dell.com">www.dell.com</a>
My Dell app	
Tips	
Contact Support	In Windows search, type <code>Contact Support</code> , and press Enter.
Online help for operating system	<a href="http://www.dell.com/support/windows">www.dell.com/support/windows</a>
Access top solutions, diagnostics, drivers and downloads, and learn more about your computer through videos, manuals and documents.	Your Dell computer is uniquely identified by a Service Tag or Express Service Code. To view relevant support resources for your Dell computer, enter the Service Tag or Express Service Code at <a href="http://www.dell.com/support">www.dell.com/support</a> .  For more information on how to find the Service Tag for your computer, see <a href="#">Locate the Service Tag on your computer</a> .
Dell knowledge base articles for a variety of computer concerns	<ol style="list-style-type: none"> <li>1. Go to <a href="http://www.dell.com/support">www.dell.com/support</a>.</li> <li>2. On the menu bar at the top of the Support page, select <b>Support &gt; Knowledge Base</b>.</li> <li>3. In the Search field on the Knowledge Base page, type the keyword, topic, or model number, and then click or tap the search icon to view the related articles.</li> </ol>

## Contacting Dell

To contact Dell for sales, technical support, or customer service issues, see [www.dell.com/contactdell](http://www.dell.com/contactdell).

 **NOTE:** Availability varies by country/region and product, and some services may not be available in your country/region.

 **NOTE:** If you do not have an active Internet connection, you can find contact information about your purchase invoice, packing slip, bill, or Dell product catalog.