

**ILIFE L100**

Laser Navigation Robotic Vacuum

# User Manual

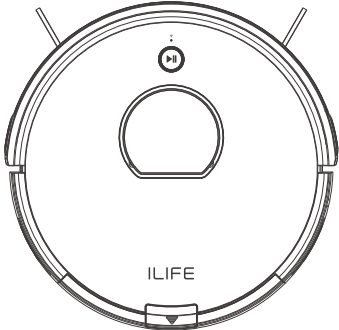

For more information,  
visit [www.iliferobot.com](http://www.iliferobot.com)

**ILIFE**



Dear Customer,

Thank you for purchasing ILIFE L100 robot vacuum cleaner!  
You've joined the millions of people who clean with robots - the smarter way to get it down.

Please take a few moments to read this manual and get acquainted with your robot, to get the best performance from your robot. If you have any problem, please don't worry, you are supposed to contact our customer service first or visit our website at [www.iliferobot.com](http://www.iliferobot.com) for more information.

Stay connected with us on Facebook and twitter to enjoy these exclusive benefits:

- Get support tailored to your specific robot, including answers to questions, maintenance tips, video demos, live chat and more.
- Get product updates and other valuable information about new robots, exclusive discounts and special promotions.

Connect with us right now at  
Facebook: [facebook.com/ilferobotics](https://facebook.com/ilferobotics)  
Twitter: [twitter.com/ILIFEROBOTICS](https://twitter.com/ILIFEROBOTICS)

Enjoy a thorough clean every day in your life!  
Best regards,  
ILIFE Innovation

## Table of Contents

<b>Safety Instructions</b> .....	3
<b>Product Components</b> .....	5
Main Body .....	5
Dustbin/Water Tank .....	6
Charging Dock/Remote Control .....	7
List of Accessories .....	8
Product Specifications .....	8
<b>How To Use</b> .....	9
Charging .....	9
Start/Pause/Sleep .....	11
Cleaning Modes .....	12
Schedule Mode .....	14
Water Tank .....	16
<b>APP Download</b> .....	17
<b>Maintenance</b> .....	18
Cleaning Side Brushes & Main Brush .....	18
Cleaning Sensors & Charging Pins .....	18
Cleaning Dustbin & Filters .....	19
Cleaning Water Tank Components .....	20
<b>Troubleshooting</b> .....	21
Alert Reference .....	21

## Safety instructions

---

**Before using this product, please read the following safety precautions.**

- Read this user manual thoroughly and carefully before using this product.
- Save this user manual.
- Any operations that oppose to descriptions in this user manual may lead to harm to human or this product.

### **WARNING**

1. Only the certified technician may disassemble the product. Users are not allowed to disassemble or repair the product.
2. Only use the adapter provided by the factory. Using other un-matched adapter may cause electric shock, fire or product damage.
3. Do not touch the power cord, plug or adapter when your hands are wet.
4. Do not make clothes or part of a body drawn into the product's wheels.
5. Do not make this product close to cigarette, lighter, match or any flammables.
6. If the product is needed to clean, clean it after charging is stopped.
7. Do not over-bend the power cord or pressure the power cord with heavy or sharp objects.
8. This product is used only indoors, do not use it outdoors.
9. Do not sit on top of this product or attach an object on the top of it.
10. Do not use this product in wet or moist environment (any environment with liquid).
11. Before use, remove all the damageable objects (textile, glass, lighting, etc) and objects that could get caught in the brushes or suck passage(cords, clothing, papers, drapes, blinds, etc).
12. Do not place this product where it is easy to drop off (tables, chairs, etc).
13. Turn off the power switch during transportation or when you don't need to use this product for a long time.
14. Before use, check whether adapter and outlet are properly connected. Or else the battery may be damaged.
15. To avoid tripping, inform all the people in the house when this product is working.

## Safety instructions

---

16. Do not use this product when dustbin is full.
17. Use this product in temperature from  $-10^{\circ}$  to  $50^{\circ}$  (centigrade degree).
18. Do not place this product in high-temperature environment.
19. The battery must be removed from the product before it is scrapped.
20. The product must be disconnected from the supply mains when removing the battery.
21. The battery is to be disposed of safety.
22. Use factory-authorized battery only, do not use unmatched battery.

**NOTE:**

This product could not be used by children, mentally challenged people or people lack of related experience and knowledge (Unless there people instruct or supervise them).

## Product Components

### Main Body

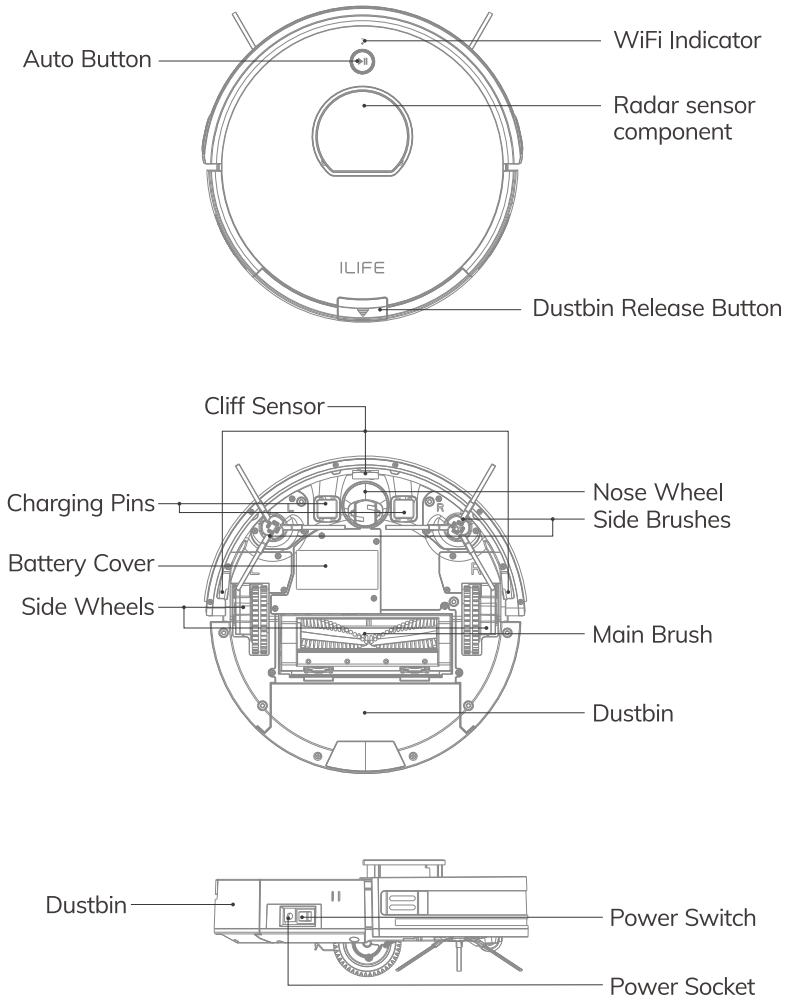

# Product Components

## Dustbin

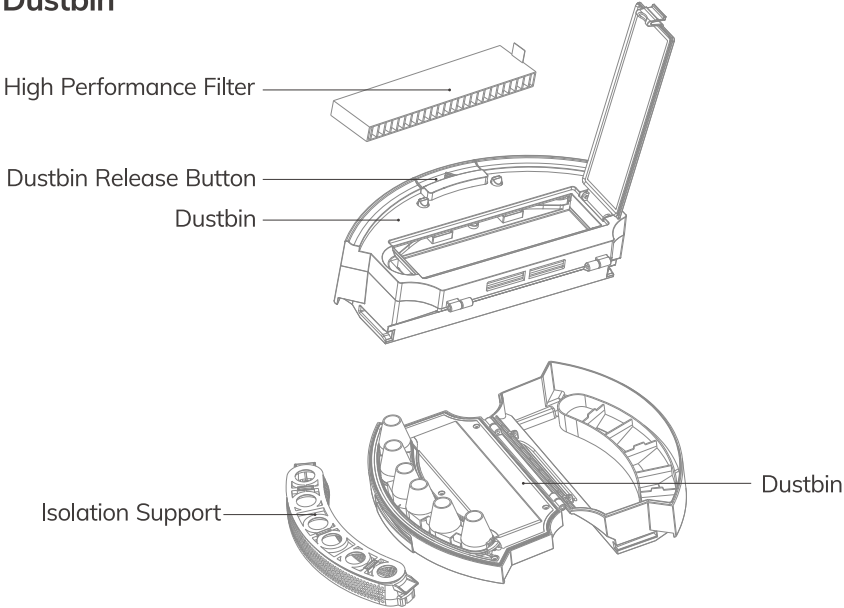

## Water Tank

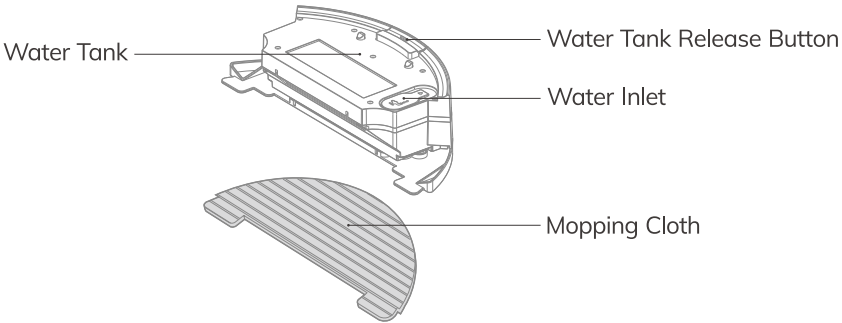



## Product Components

### Charging Dock

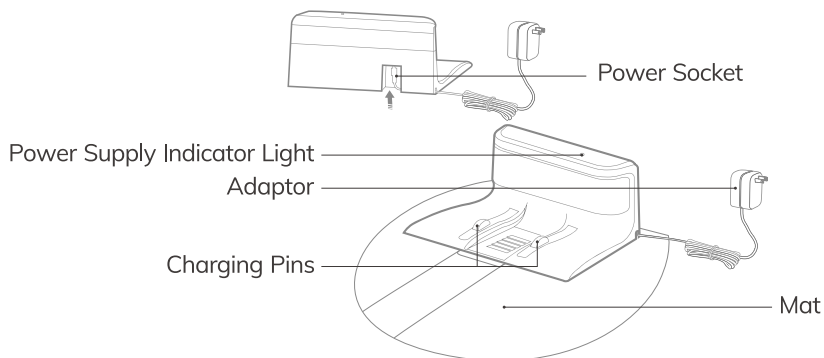

### Remote Control

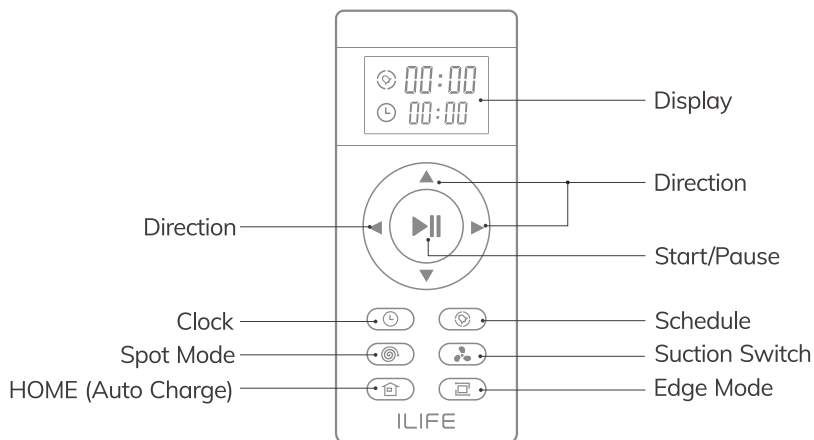

**Note:** “▲” “▼” “▶” “◀” cannot be used during a cleaning cycle.

## Product Components

### List of Accessories

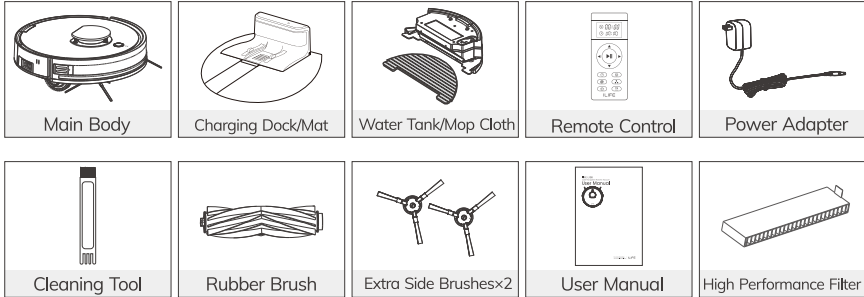

### Product Specifications

Type	Description	Specification
Mechanical	Diameter	330mm
	Height	95mm
	Net Weight	2.65kg
Electrical	Battery Type	Li-ion
	Charging Methods	Auto Charging / Manual Charging
Cleaning	Dustbin Capacity	0.45L
	Water Tank Capacity	0.3L
	Cleaning Modes	Auto, Spot, Edge, Daily Schedule
	Charging Time	<380mins
	Cleaning Time	>90mins
Main Body		Mechanical Button

## How To Use

### Charging

#### 1. Placing Charging Dock

- Plug the adaptor into the charging dock;
- Align it well and place the mat under the charging dock;
- Put the charging dock against a wall and remove obstacles and reflective objects about 1 meter on both sides and about 2 meters in front;
- Connect to power.

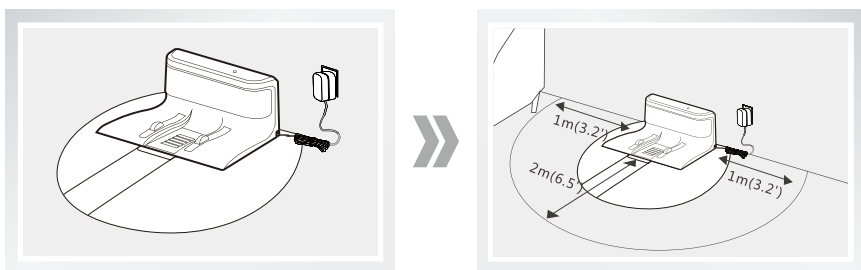

**Note:**

Once connected to power, indicator light on the charging dock stays on.

#### 2. Turning on Power Switch

Turn on the power switch on the side of the main body.  
"—" is ON and "O" is OFF.

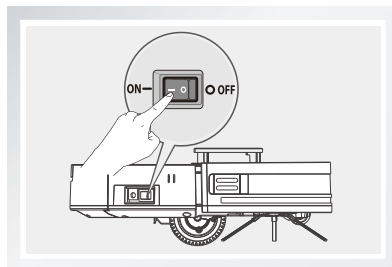

**Note:**

Do not switch off the robot after use.  
Always keep the robot fully charged for the next task.

## How To Use

### 3. Charging the Robot

#### A. Auto Charge

- When battery runs low in Auto mode, robot will automatically search the charging dock for recharge.
- While on standby, press  button on the remote control. Robot will start searching the charging dock for recharge.

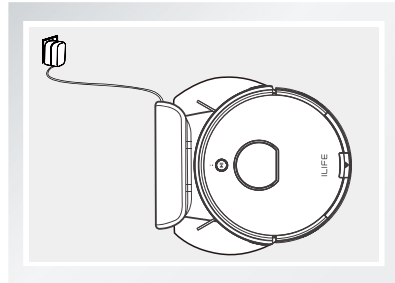
**Reminder:**

To avoid lowered charging performance, make sure the charging pads on the main body and charging dock are clean.

#### B. Manual Charge

- Turn on the power switch on the side of the main body. Plug in the adaptor and connect to power.

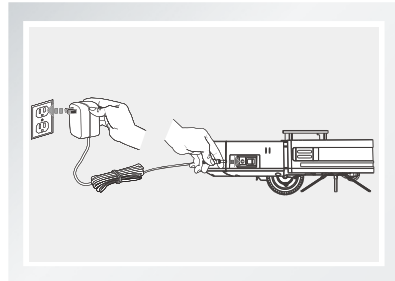
**Reminders:**

1. For regular use, always leave the main body on the charging dock, and make sure its power switch is turned on.
2. If the robot will not be used for a long time, fully charge it before storing in a cool, dry place.
3. Do not charge the robot manually after a cleaning schedule is set. Robot will not execute scheduled cleaning after manual charge.



## How To Use

---

### Start/Pause/Sleep

- **Sleep:** Robot is idle; Power switch is on and indicator light is off.
- **Standby:** Robot is not working; Power switch is on and light at main button is pulsing.
- **Start:** Robot is working; Green light at Auto button stays on.



#### 1 Turn on the Robot

- Turn on the power switch on the side of the main body.
- Press  on the main body to start cleaning.
- Press  on the remote control to start cleaning.

**Note:**

While in Sleep mode, press  to activate standby mode. Press  again to start cleaning.

#### 2 Pause

- Pause means switching from cleaning to standby. To pause a cleaning cycle, press  on the remote control or  on the main body.

**Note:**

The robot accepts new tasks once it is paused.

#### 3 Sleep

- To enter Sleep Mode:
  - A. Press and hold  for 3 seconds.
  - B. Robot enters Sleep mode automatically after idling for 10 minutes.



## How To Use

### Cleaning Modes

Multiple cleaning modes allow robot to perform deep cleaning in different environment and on different floorings. Use the remote control to select a suitable cleaning mode.

- \* Before select cleaning modes,make sure the robot is standby (power switch is on and the auto button is lighting green).

#### 1 Auto Mode

The most frequently used cleaning mode. Press  on the main body or  on the remote control. Robot plans a path and cleans along a zigzag pattern. During cleaning, robot detects and cleans areas that have been missed.

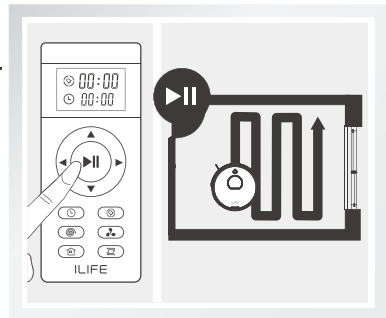

- \* Robot plans a cleaning path autonomously during a cleaning cycle. If robot is moved manually or with the remote control, it will plan a new path and may repeat areas that have been cleaned.
- \* Robot may stop working briefly during a cleaning cycle. Wait patiently for it to detect areas that have been missed or to revise the cleaning path. The number and duration of these brief stops depend on the complexity of the home environment.

#### 2 Spot Mode

Robot takes a square path to clean a specific area with concentrated dust and debris.

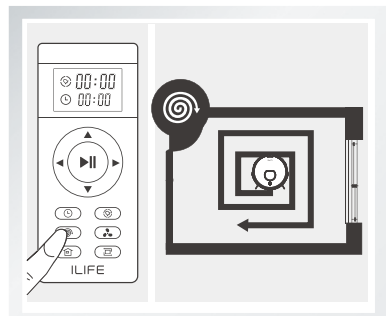

## How To Use

### 3 Edge Mode

While on standby, robot moves forward until it detects a wall. It cleans around the edges of the walls about once.

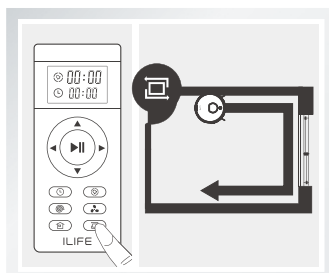

### 4 Suction Switch

Suction can be strengthened or weakened to meet different cleaning needs. Press the button (represented by a person icon) on remote control to switch to different suction level.

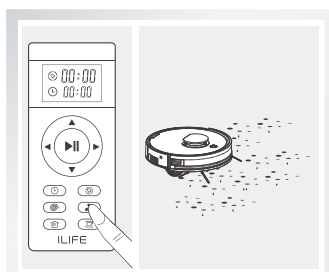

### 5 Auto Charge

When battery runs low during a cleaning cycle, robot will automatically activate "Auto Charge" function -- searching and returning to charging dock for recharge.

\* Auto Charge can also be activated by pressing (represented by a house icon) on the remote control.

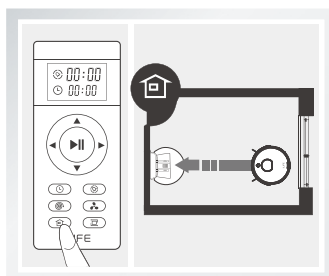

## How To Use

### Schedule Mode

To offer a complete automatic cleaning experience, robot receives preset cleaning schedules. Set local time and schedules with the remote control or mobile APP. Robot will start cleaning automatically at the preset time every day.

\* Before setting local time and cleaning schedules, make sure the power switch on the main body is switched on. A green flashing light indicates robot is activated from Sleep mode. To activate robot, tap **⏻** on the main body or **▶▶** on the remote control.

#### 1 Set Local Time with Remote Control

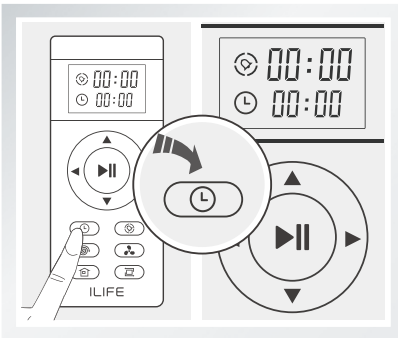

Tap **L** button. Remote control display will show **L** and flashing **00:00**.

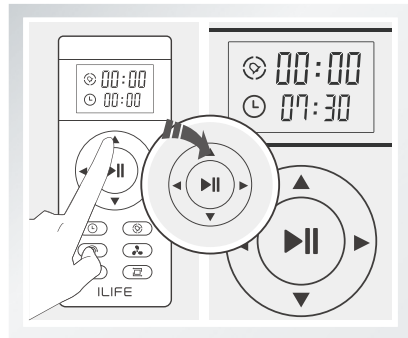

Adjust time with “▲” “▼” button. To set local time, press “◀” “▶” to change from hours to minute.

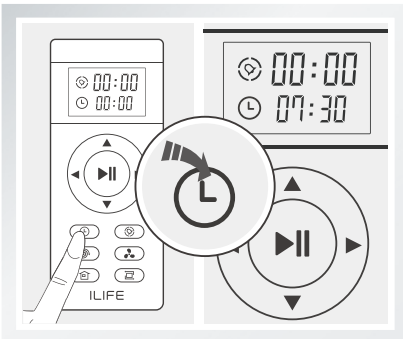

Press **L** to save local time.

\* Voice announcement will confirm the completion of setting



## How To Use

### 2 Set a schedule

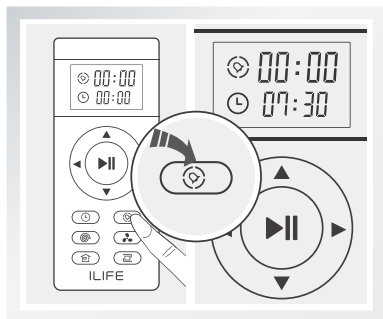

Tap . Remote control display will show  and flashing 00:00.

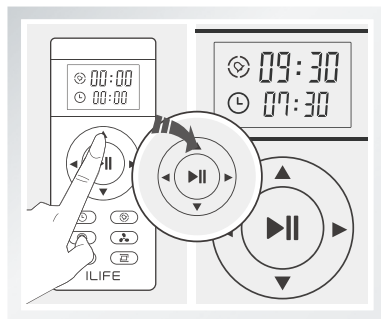

Use direction buttons to adjust schedule time.

Press  to save a schedule.

\* Voice announcement will confirm a successful schedule, and robot will start working at the preset times.

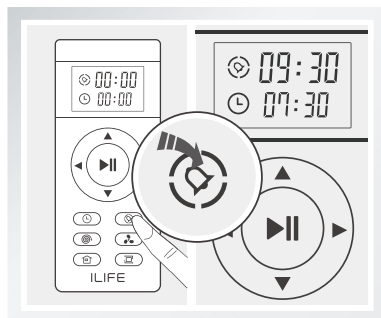

### 3 Cancel a Schedule

Adjust schedule time to "00:00" and save; or turn off the power switch on the main body.

- \* Please pay attention to the voice prompt to see if the robot is successfully scheduled.
- \* Rescheduling is required after changing batteries in the remote control.

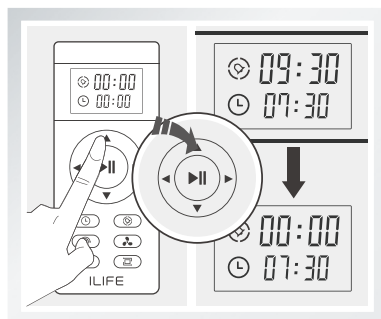

## How To Use

### Water Tank

This product contains water tank components. After sweeping and vacuuming, replace the dustbin with the water tank for mopping function.



- \* If a cleaning cycle is paused for water refill or mop cloth cleaning, robot will plan and start a new cleaning path. Completed areas may be cleaned again. For best performance, mop one room at a time.
- \* Manually move robot to another room that requires mopping. Refill water and clean the mop cloth, if necessary, before robot starts mopping.

- \* Do not use the water tank on carpet. To prevent mop cloth from staining the carpet, roll up the carpet edges before mopping.
- \* Make sure there is enough water for mopping during cleaning. Refill water when needed. Remove the water tank before a refill.
- \* Remove the water tank before charging.

#### 1 Water Refill

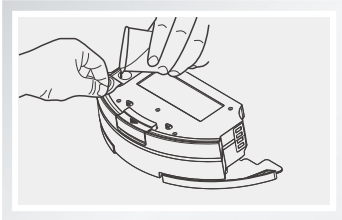

Open the water inlet cap.  
Slowly pour in water with a cup.

#### 2 Attach Mop Cloth

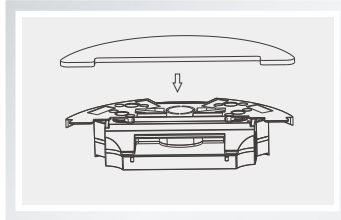

Close the cap tight and attach the mop cloth firmly.  
Secure with the rings on both sides.

#### 3 Install Water Tank

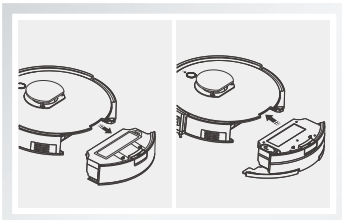

Press dustbin release button to remove the dustbin and replace with the water tank.

#### 4 Mopping

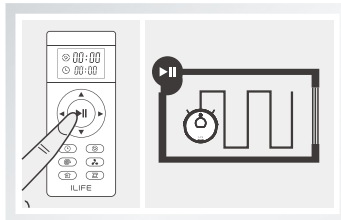

Press Auto button to start mopping and vacuuming.

## APP Download

---

The robot can be controlled by the “ILIFEHOME” app. Scan the QR code to install the app on your iOS or Android device.



 ILIFEHOME APP



 ILIFEHOME APP

## Maintenance

Make sure the main body is turned off and adaptor is unplugged before accessories maintenance.

### Cleaning Side Brushes & Main Brush

#### Cleaning Side Brushes

Remove side brushes.  
Wipe clean with a clean cloth.

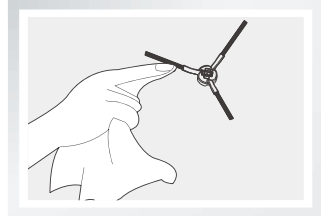

#### Cleaning Main Brush

Remove main brush cover. Take out main brush. Cut the hair winding around the brush for easy removal.

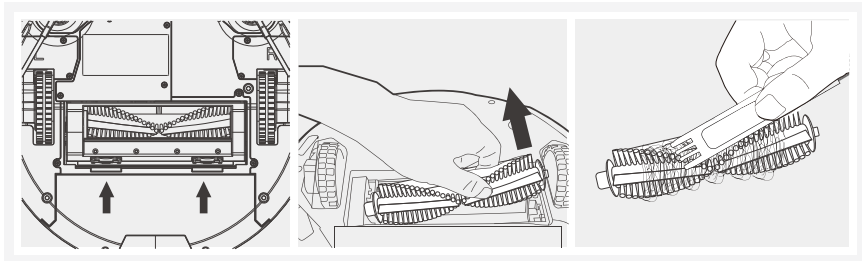

### Cleaning Sensors & Charging Pins

Use cleaning tools or a soft cloth to clean the sensors and charging pins:  
**Note:** Remove dust or foreign objects on sensors and charging pins on the charging dock as soon as possible.

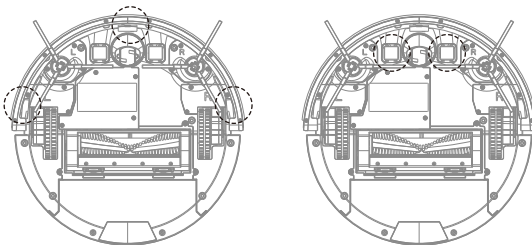

## Maintenance

### Cleaning Dustbin & Filters

Clean dustbin and filters after each use:

- A. Take out the dustbin. Check the suction port if there is anything stuck in it. Clean suction port if needed.
- B. Wash replaceable primary filter with water every 15-30 days. Do not squeeze. Air dry after wash.
- C. Tap to remove dust from the high-performance filter. Do not wash with water.

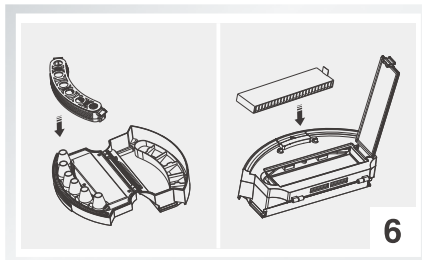
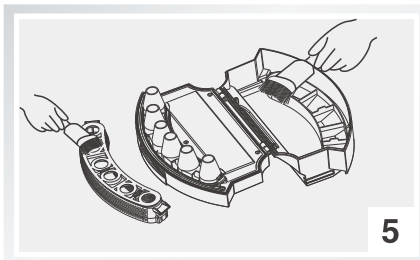
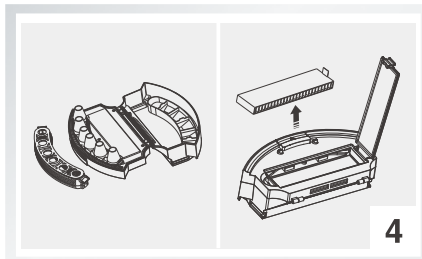
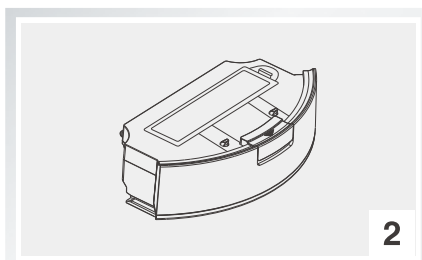
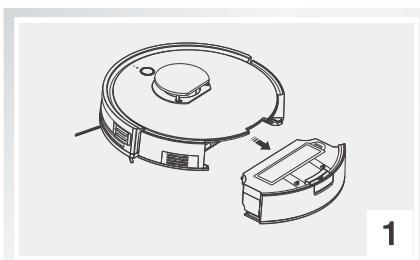

## Maintenance

### Cleaning Water Tank Components

#### 1. Cleaning Mop Cloth

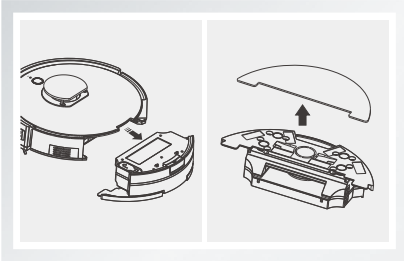

**Remove:** Take out the water tank and mop cloth after each use.

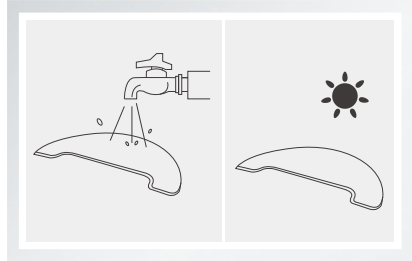

**Maintenance:** Rinse and dry the mop cloth.

#### 2. Cleaning Water Tank

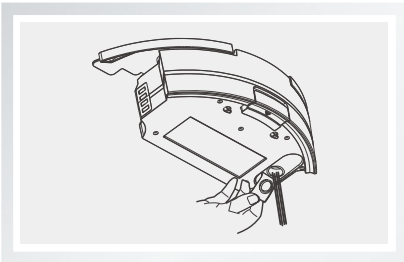

**Remove:** After each use, remove water tank and mop cloth, and empty the water tank.

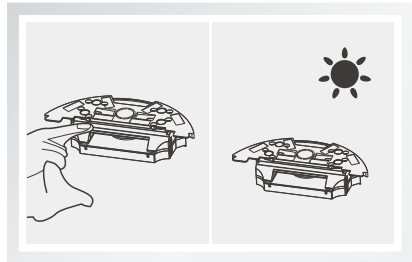



**Maintenance:** Wipe water tank with a dry cloth before air drying. Do not rinse the water tank directly with water.

**Note:** Do not submerge vibrating water tank in water.

## Troubleshooting

### Alert Reference

In case of errors, red light stays on with voice announcement.

No.	Voice announcement	Possible causes	What to do
01	Please clean left side brush.	Left side brush error.	Remove and clean left side brush.
02	Please clean right side brush.	Right side brush error.	Remove and clean right side brush.
03	Please check left wheel.	Left side wheel error.	Check and clean left side wheel.
04	Please check right wheel.	Right side wheel error.	Check and clean right side wheel.
05	Please check and clean turbo brush.	Turbo brush error.	Remove and clean turbo brush and brush channel.
06	Please put robot to open area.	Robot is stuck.	Restart robot at an unblocked spot.
07	Please clap front bumper.	Bumper error.	Tap bumper to confirm it moves normally and is on track.
08	Please clean drop sensors.	Drop sensors error.	Check drop sensors.
09	Please check radar sensor.	Radar sensor error	Check radar sensor, restart the robot again.
10	Please put robot back to ground.	Robot is lifted up.	Relocate robot to a flat surface.
11	Please pull out the plug from robot.	Press  after plugging in adapter.	/
12	Please turn on power switch.	Press  while robot is charging on charging dock.	Turn on power switch. “-” is ON and “O” is off.

#### Reminders:

If the solutions above don't help:

1. Restart the main body by turning on the power switch on the side.
2. If problems persist, send robot to the nearest repair service center.