

KENT
Mineral RO™
 Water Purifiers
 HOUSE of PURITY



Marketed by:
 KENT RO SYSTEMS LTD.
 E-6, 7 & 8, Sector-59, Noida, U.P.-201 309, India.
 E-mail: sales@kent.co.in | Website: www.kent.co.in

Manufactured by:
 KENT RO SYSTEMS LTD.
 1) Khasra No. 93, Village-Bantakhedi, Tehsil-Roorkee,
 District-Haridwar, Uttarakhand-247 668, India.
 2) A-6, Sector-87, Noida-201305, U.P., India.

For customer complaints, contact our Customer Care Officer at:
 E-6, 7 & 8, Sector-59, Noida, U.P.-201 309, India. Call : 92-789-12345
 E-mail: service@kent.co.in or visit us at www.kent.co.in

December, 2018

KENT
PRIDE PLUS
 Mineral RO™ Water Purifier
 With UV Disinfection in Tank

KENT
Mineral RO™
 Water Purifiers
 HOUSE of PURITY

Instructions Handbook



Mineral RO™ TECHNOLOGY

Removes Dissolved Impurities
 Retains Essential Minerals
 Multiple Purification

RO + UF + TDS Control + UV in Tank

Kent Deta Hai
Sabse
Shudh Paani

Reverse Osmosis Water Purifier with UV Sterilization & TDS Controller.

Welcome to KENT

Dear Customer,

At the outset, allow us to thank you for your trust in **KENT** water purifier. We take pride in our reputation for product quality and industry proven performance. We are certain that your decision to own **KENT Pride Plus Mineral RO™ Water Purifier** will go a long way towards keeping you and your family in good health. We are confident that you will be satisfied with its performance and that it will serve your need for safer and cleaner drinking water without any compromise.

This guide will help you in getting the best out of your water purifier. Please go through this booklet to familiarise yourself with its operation and maintenance. In case you need any further information, contact your nearest KENT dealer/branch.

Best Wishes,

KENT RO SYSTEMS LTD.

Table of Contents

1. KENT TECHNOLOGY - A Breakthrough in Water Purification	1
2. Salient Features	1
3. Items in the Box	1
4. Important Instructions	2
5. Reverse Osmosis Process	3
6. UV Process	3
7. Water Flow Diagram	4
8. Electrical Circuit Diagram	4
9. UV LED Failure Alarm	5
10. Installation Instructions	5
11. TDS Adjustment	6
12. Starting-up the Purifier	6
13. Recommended Uses of Rejected Water	6
14. Maintenance	7
15. Important Safety Instructions	7
16. Technical Specifications	8

KENT TECHNOLOGY - A Breakthrough in Water Purification*

Presenting **KENT Pride Plus Mineral RO™ Water Purifier**; it uses futuristic and state-of-the-art technology to provide purer and healthier drinking water.

At the heart of **KENT Pride Plus Mineral RO™ Water Purifier** is a Reverse Osmosis membrane with capillaries as small as 0.0001 microns that reduce even dissolved impurities (salts and heavy metals) and even converts hard water to sweet and purer drinking water. The **KENT Pride Plus Mineral RO™ Water Purifier** also allows the user to control the Total Dissolved Solids (TDS) level of purified water.

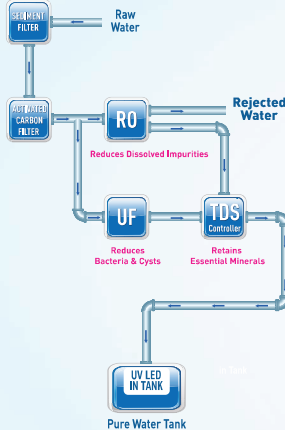









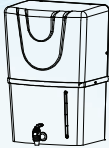

Salient Features of KENT Pride Plus Mineral RO™ Water Purifier

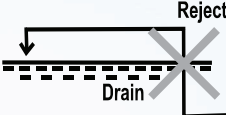
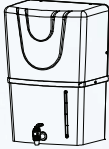
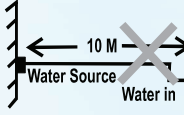
- Water purifier with UV disinfection in tank for absolute purification
- Wall-mountable KENT Technology water purifier
- Purification by RO + UF + TDS Control + UV in tank makes water 100% pure
- Inbuilt TDS Controller that allows adjustment of TDS level of purified water
- Suitable for purification of brackish/ tap water/ municipal corporation water supply
- 8L storage tank with water level indicator
- Fully automatic operation, with auto-on/off function
- RO Membrane fused inside membrane housing to prevent tampering
- Vertically mounted SMPS for protection from water
- Use of push-fit fittings for leakage and maintenance free performance
- Compact design, takes less space for installation
- ABS construction for corrosion free use

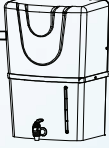
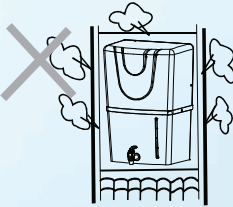
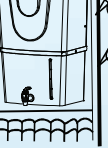
Items in the Box

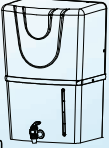
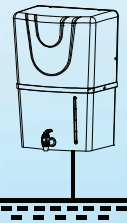
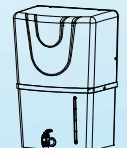
1. KENT Pride Plus Mineral RO™ Water Purifier	:	01 No.
2. 3-Way Connector	:	01 No.
3. S.S. Ball Valve	:	01 No.
4. Food Grade Pipe ¼ inch (Blue)	:	2.5 m
5. Food Grade Pipe ⅜ inch (White)	:	2.5 m
6. Screws & Plastic Insert	:	02 No. each
7. Warranty Card	:	01 No.
8. Sticker Center Drill	:	01 No.

Important Instructions

 <p>Avoid exposure to direct sunlight and installation in damp areas.</p> 	 <p>Make sure that the temperature of the water entering the purifier is within 10° C - 40° C.</p> 
 <p>Reject Water Drain</p> <p>Make sure that the reject water pipe is not placed at a level higher than the system, otherwise the rejected water may flow backwards into the purifier.</p> 	 <p>10 M Water Source Water in</p> <p>Maximum distance between the water source and the purifier should not be more than 3 meters.</p> 
 <p>Avoid sharp bends in the pipe fittings. Do not bend or block the reject water pipe.</p> 	 <p>Do not confine the purifier in a cabinet.</p> 
 <p>In case of not using the purifier for more than two days, kindly switch off the power supply and drain the storage tank.</p> 	 <p>To keep the storage tank clean, it should be drained once in 15 days.</p> 
<div style="text-align: center;">  <p>Use Genuine KENT Spares for optimum performance.</p> </div> <div style="float: right; text-align: center;">  <p>Do not try to service the purifier on your own. Instead, call a technician for help.</p>  </div>	

Reverse Osmosis Process

The Reverse Osmosis process, also known as hyper filtration, is the finest filtration process known till date. The process ensures reduction of particles as small as ions from a solution. Reverse Osmosis uses a semi-permeable membrane to reduce salts from potable/brackish water. In Reverse Osmosis, water pressure applied to the concentrated side forces the process of osmosis into reverse. Under enough pressure, treated water is "squeezed" through the membrane from the concentrated side to the diluted side. Salts dissolved in water as charged ions are repelled by the RO membrane. The rejected impurities on the concentrated side of the membrane are washed away in a stream of waste water and thus do not get accumulated, as in a traditional filter.

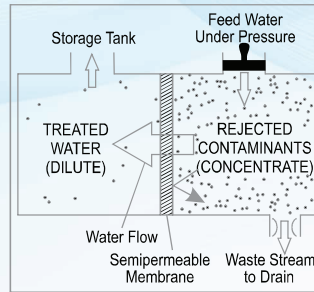

UV Process

The UV light has shorter wavelength (higher energy) than the visible light. It is called ultra-violet because it is just beyond the violet light in the light spectrum. Technically, the ultra-violet light is defined to be any wavelength of light, which is shorter than 400 nanometer.

UV rays, which penetrate into the micro-organisms, are absorbed by the DNA of the pathogen in the water. The DNA is altered in such a way that the pathogen cannot reproduce itself. Thus, it is essentially killed and cannot cause infection. This process of DNA modification is called inactivation.

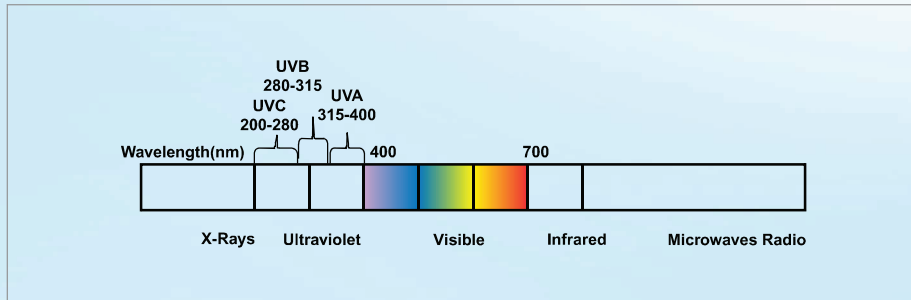

Note: The purified water stored in tank is disinfected using LED UV, which automatically switches on for 30 minutes in a two hour cycle.

Water Flow Diagram

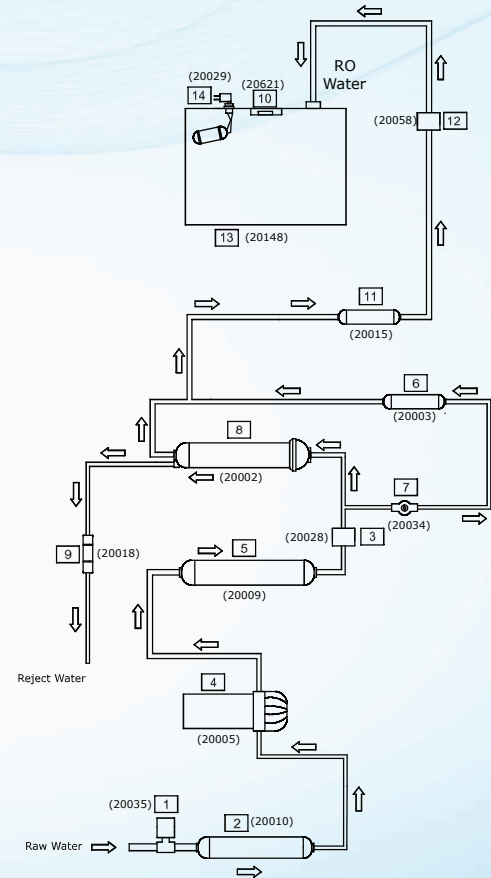

S.NO.	SPARE PART CODE	ITEM DESCRIPTION
1	20035	LOW PRESSURE SWITCH
2	20010	SEDIMENT FILTER
3	20028	SOLENOID VALVE
4	20005	BOOSTER PUMP
5	20009	ACTIVATED CARBON FILTER
6	20003	UF FILTER
7	20034	TDS CONTROL VALVE
8	20002	RO MEMBRANE
9	20018	FLOW RESTRICTOR TUBE
10	20621	UV LED
11	20015	POST CARBON FILTER
12	20058	NON RETURN VALVE
13	20148	WATER STORAGE TANK
14	20029	FLOAT MICRO SWITCH

Electrical Circuit Diagram

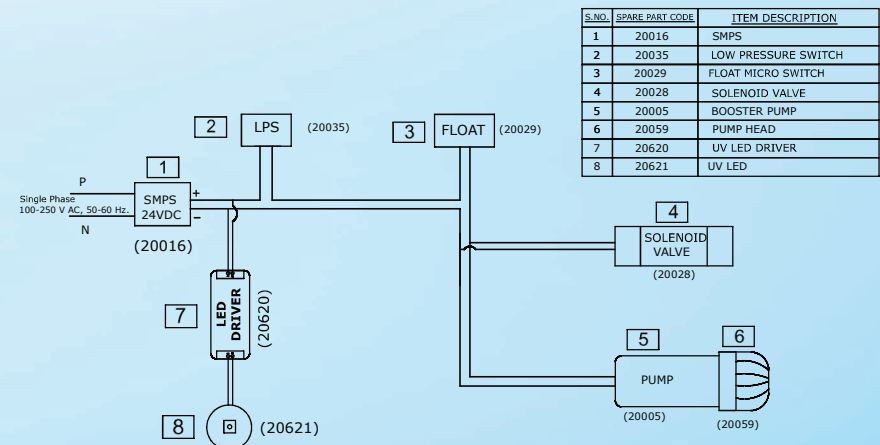

S.NO.	SPARE PART CODE	ITEM DESCRIPTION
1	20016	SMPS
2	20035	LOW PRESSURE SWITCH
3	20029	FLOAT MICRO SWITCH
4	20028	SOLENOID VALVE
5	20005	BOOSTER PUMP
6	20059	PUMP HEAD
7	20620	UV LED DRIVER
8	20621	UV LED

UV LED Failure Alarm*

KENT Pride Plus Mineral RO™ Water Purifier has an in-built feature that sounds an audible alarm if the UV LED failure.

This alarm will sound as follows:

2 short beeps after every 3 seconds for 3 minutes. The alarm will repeat after every 2.5 hours.



In case such an alarm is audible, call KENT service for LED replacement.

Installation Instructions

The KENT Pride Plus Mineral RO™ Water Purifier is a product of advanced technology which ensures safe and clean drinking water. The purifier is easy and convenient to install.

Recommended Site Preparations:

- Single Phase 100-250V AC, 50-60 Hz. connection not more than 3m away from the point of installation of purifier
- Raw water supply with ½ inch nipple not more than 3m away
- Drain for rejected water not more than 3m away
- Space as per dimensions of the purifier
- Wall/plane surface for mounting two screws and holding the machine
- The system and installation must comply with state and local laws and regulations

Specific Instructions:

- KENT Pride Plus Mineral RO™ Water Purifier is a wall mountable purifier. Make sure that it is only mounted on a wall. Avoid installation on wooden and metallic stands
- For optimum performance and minimum inlet pressure required, ensure that the raw water supply tank is at least 10ft above the level at which the purifier is installed
- It is preferable to install the purifier near a sink so that inlet and reject water lines are easily available

Installation Procedure:

Wall Hanging Diagram

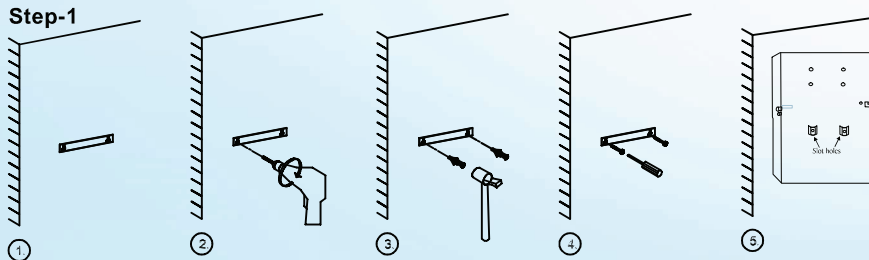

1. Paste the central drill sticker on wall at (3.6 Feet to 4.0 Feet from the ground) as per your convenience.
2. Ensure that the sticker is pasted straight on the wall, then drill holes as per the space provided on sticker.
3. Now, insert the puff up with the help of a hammer.
4. Screw in two 10X50 self-taping screws, 5.4 inches (138 mm) apart horizontally.
5. Carefully hang the purifier on the wall with the help of the wall-mounting slot holes provided on the back side of the purifier.

Note:

1. If the wall is not straight or the screws are not properly drilled in an even position, it will damage your purifier.
2. Keep the device away from heat or direct sunlight.

Step-2

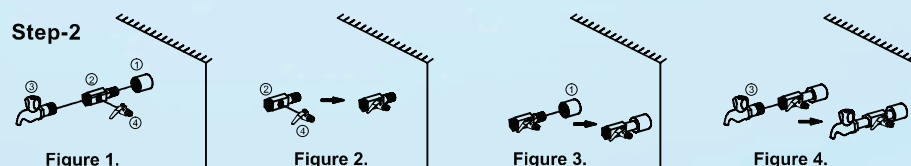

1. First fix the SS ball valve (marked as no. 4) to the 1/4 inch port of the 3-way connector (marked as no. 2) as shown in figure 2.
2. Connect the 3-way connector to the raw water supply (marked as no. 1) as shown in the figure 3. The 3-way connector is fitted in line with the raw water supply.
3. The other end of the 3-way connector can be connected to a tap (marked as no.3) as shown in figure 4. or can be plugged off if not required.

Step-3

1. Now connect one end of the white pipe to SS ball valve and another end to the upper push-fit elbow fitting to the left hand side of the purifier labelled as WATER IN, as shown in fig 1.
2. Similarly, connect one end of the white pipe to the lower elbow fitting connector in tank labelled as REJECT WATER and leave the other end in the drain, as shown in fig 2.

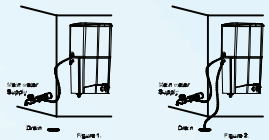

Step-4

Before connecting the power supply, it is important that you perform the following functions:

1. Open the SS ball valve (handle parallel to the ball valve) to start the flow of water into the purifier, as shown in the figure.
2. Wait for 2-3 minutes to ensure that the filters are soaked in water.

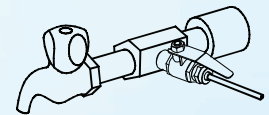

Step-5

1. Connect the power supply.
2. Installation is complete.

TDS Adjustment*

A unique feature in KENT Pride Plus Mineral RO™ Water Purifier is the TDS control valve, which is not available in any other domestic water purifier till date. This feature allows the user to control the content of natural minerals (TDS) in purified water.

To increase the TDS level, the user can turn the screw of the valve anticlockwise; it will result in more

mineral content in treated water. To reduce the TDS level, user can turn the screw valve clockwise, it will result in less mineral content in treated water. We recommend the TDS of the purifier to be kept at lowest but not below 50mg/l.

Starting-up the Purifier

- Switch on the power supply
- Wait till the storage tank fully fills up**
- Switch off the power supply
- Drain the storage tank by opening the drain plug present at the bottom of the storage tank so
- as to remove any dust particles present in the pipes and storage tank
- Close the drain plug & switch on the power supply
- The purifier is ready to use

Recommended Uses of Rejected Water

This rejected water usually goes down the drain but if required, can be used for gardening purposes. It has high concentration of salts and

minerals which accelerate plant growth. Rejected water can also be used for cleaning purposes, i.e. utensils cleaning, mopping, etc.

* Tested & Certified by TUV-SUD South Asia (P) Ltd.

** Tested or certified flushing time - 24hrs.

Maintenance

To ensure that the purifier operates at its optimum level, routine maintenance must be performed. The frequency of the maintenance will greatly depend upon the raw water quality and consumption of treated water.

- The storage tank must be drained once in 2 weeks. To do so, switch off the power supply, open the drain plug at the bottom of the tank & allow the water to drain. Then screw back the plug and switch on the power supply
- Replace sediment, activated carbon & post

carbon when the filter change alarm is audible OR after every 12 months. It is recommended to change the FRT when the filters are replaced

- Replace the RO membrane once in a year
- Replace the UV Lamp once in a year
- If you are not going to use the purifier for a long time (in case you are on a holiday, tour or out of home), make sure that you disconnect the power supply, turn off the raw water supply and drain the storage tank

The reverse osmosis system contains a replaceable treatment component critical for the effective reduction of total dissolved solids and that product water shall be tested periodically to verify that the system is performing properly.

Replacement of spare parts are as under:-

-20010	SP	Inline Sediment Filter 8"
-20009	SP	Inline Carbon Filter 8"
-20002	SP	RO Membrane Welded 8" Housing
-20015	SP	Post Carbon Filter (Blue)
-20003	SP	Hollow Fibre Membrane (RO)
-20018	SP	FRT 550/600

Note: Filters and membrane are consumables. Their replacement time is dependent on the quality of raw water and water consumption. They are not covered under the warranty. However, if a filter chokes within six months and a membrane within a year, it will be cleaned/repared/replaced free of cost. Changing the filters and system inspection is available on call. The treatment capacity of the RO membrane will reduce with time due to clogging of pores of membranes.

"This reverse osmosis system contains a replaceable component critical to the efficiency of the system. Replacement of the reverse osmosis component should be with one of identical specifications as defined by the manufacturer, to ensure the same efficiency and contaminant reduction performance.

Note: In case of UV LED failure the machine sounds an alarm with two beeps. Contact Kent Service to replace the UV LED."

Important Safety Instructions

- If the supply cord is damaged, it must be replaced by the manufacturer, its service agent or similarly qualified persons in order to avoid hazard
- Children should be supervised to ensure that they do not play with the appliance
- This appliance is not intended for use by persons (including children) with reduced physical, sensory or mental capabilities, or lack of experience and knowledge, unless they have been given supervision or instruction concerning use of the appliance by a person responsible for their safety

Technical Specifications

Product	KENT PRIDE PLUS
Product Code	111067
Product Generic Name	Water Purifier
Colour	White
Applications	Suitable for Purification of Brackish/Tap Water/ Municipal Corporation Water.
Purification Production Rate	15 L/hr.*
Body Material	ABS Food Grade Plastic
Mounting	Wall-mounting
Dimensions (mm)	380 (L) x 270 (W) x 505 (H)
Inlet Water Pressure/Temp (Min.)	0.3 kg/cm ² /10°C
Inlet Water Pressure/Temp (Max.)	4 kg/cm ² /40°C
Min./Max. Operating pH	6.5-8.0
Filter Cartridge	Sediment, Activated Carbon, UF and Post Carbon.
UV LED Wattage	0.7 W
Net Weight	7.45 kg
Storage Capacity	8 L
Maximum Duty Cycle	75 L/day
Membrane Type	Thin Film Composite RO
UF Membrane	0.1-0.01 Microns
Booster Pump Voltage	24 V DC
Total Power Consumption	60 W
Input Power Supply	Single Phase 100-250V AC, 50-60 Hz. 
IP Rating	IPX1

* Purification capacity tested on Municipal Water/Tap Water having TDS level of 750 ppm at room temperature.