

ILIFE-A80 Pro

Robot vacuum cleaner

User Manual

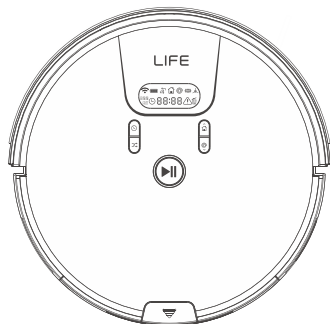

English

Русский

For more detailed information,
please visit: www.iliferobot.com

ILIFE

Dear Customer,

Thank you for purchasing ILIFE A80 Pro robot vacuum cleaner! You've joined the millions of people who clean with robots - the smarter way to get it down.

Please take a few moments to read this manual and get acquainted with your robot, to get the best performance from your robot. If you have any problem, please don't worry, you are supposed to contact our customer service first or visit our website at www.iliferobot.com for more information.

Stay connected with us on Facebook and twitter to enjoy these exclusive benefits:

- Get support tailored to your specific robot, including answers to questions, maintenance tips, video demos, live chat and more.
- Get product updates and other valuable information be among the first to find out about new robots, exclusive discounts and special promotions.

Connect with us right now at
Facebook: facebook.com/iliferobotics
Twitter: twitter.com/ILIFEROBOTUS

Enjoy a thorough clean every day in your life!
Best regards,
ILIFE Innovation

ILIFE Customer Service India



1800-258-5433



support@ilifecare.in

For more details, please visit website: www.ilifecare.in

Important Tips



A80 Pro contains electronic parts. Do Not submerge the robot or spray it with water. Clean with a dry cloth only.

For best usage

- Place the charging dock against wall in a wide open area, and do not put it near a door or stairs.
- Clear up excess clutters on floor before cleaning (e.g. cables, bar stools, etc.).
- Choose MAX mode to clean an area of highly concentrated dust.

Keep peak performance

- Remove the main brush, clean the both ends of the rolling brush and the brush motion link twice a week. (See figure 1)
- Take off the nose wheel with a screwdriver, clean hairs in the wheel cavity and the axle twice a week. (See figure 2)
- Empty dustbin box and clean filter and rolling brush after each use. Replace a new filter every month.

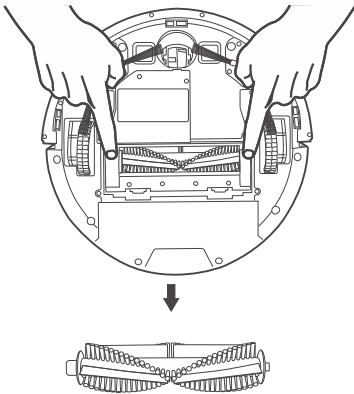

Figure 1

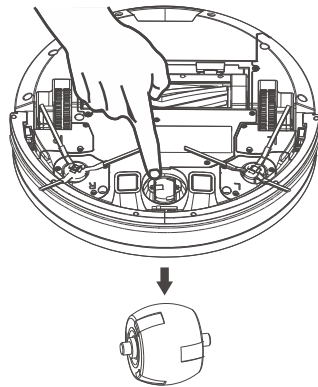

Figure 2

Contents

Safety Instructions	4
Product Parts	6
Main body and accessories	6
Main body	7
Control panel	7
Dustbin	8
Water tank	8
Remote control	8
How to Use	9
Tips for using the robot	9
Quick operation	10
Cleaning modes and functions	14
Setting a schedule	16
Water tank operation	18
APP Download	20
Maintenance	21
Dustbin	21
Water tank operation	22
Main brush and side brushes	23
Other parts	24
Alerts	25
Troubleshooting	26
Product Specifications	27

Safety Instructions

Before using this product, please read the following safety precautions.

- Read this user manual thoroughly and carefully before using this product.
- Save this user manual.
- Any operations that oppose to descriptions in this user manual may lead to harm to human or this product.

WARNING

1. Only the certified technician may disassemble the product. Users are not allowed to disassemble or repair the product.
2. Only use the adapter provided by the factory. Using other un-matched adapter may cause electric shock, fire or product damage.
3. Do not touch the power cord, plug or adapter when your hands are wet.
4. Do not make clothes or part of a body drawn into the product's wheels.
5. Do not make this product close to cigarette, lighter, match or any flammables.
6. If the product is needed to clean, clean it after charging is stopped.
7. Do not over-bend the power cord or pressure the power cord with heavy or sharp objects.
8. This product is used only indoors, do not use it outdoors.
9. Do not sit on top of this product or attach an object on the top of it.
10. Do not use this product in wet or moist environment (any environment with liquid).
11. Before use, remove all the damageable objects (textile, glass, lighting, etc) and objects that could get caught in the brushes or suck passage(cords, clothing, papers, drapes, blinds, etc).
12. Do not place this product where it is easy to drop off (tables, chairs, etc).
13. Turn off the power switch during transportation or when you don't need to use this product for a long time.
14. Before use, check whether adapter and outlet are properly connected. Or else the battery may be damaged.
15. To avoid tripping, inform all the people in the house when this product is working.

Safety Instructions

16. Do not use this product when dustbin is full.
17. Use this product in temperature from -10° to 50° (centigrade degree).
18. Do not place this product in high-temperature environment.
19. The battery must be removed from the product before it is scrapped.
20. The product must be disconnected from the supply mains when removing the battery.
21. The battery is to be disposed of safely.
22. Use factory-authorized battery only, do not use unmatched battery.



NOTE:

This product could not be used by children, mentally challenged people or people lack of related experience and knowledge (Unless there people instruct or supervise them).

Product Parts

Main body and accessories

NO.	Description	Q'ty
1	Main body	1
2	Charging dock	1
3	Remote control (battery not included)	1
4	Adapter	1
5	Water tank	1
6	Mop cloth	1
7	User manual	1
8	Cleaning tool	1
9	Extra side brushes	2
10	High performance filter	1

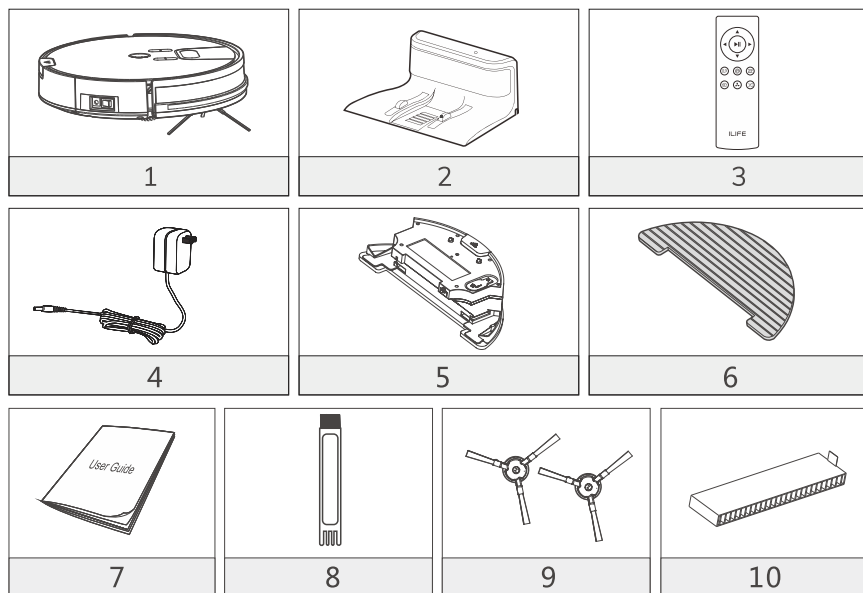

Product Parts

Main body

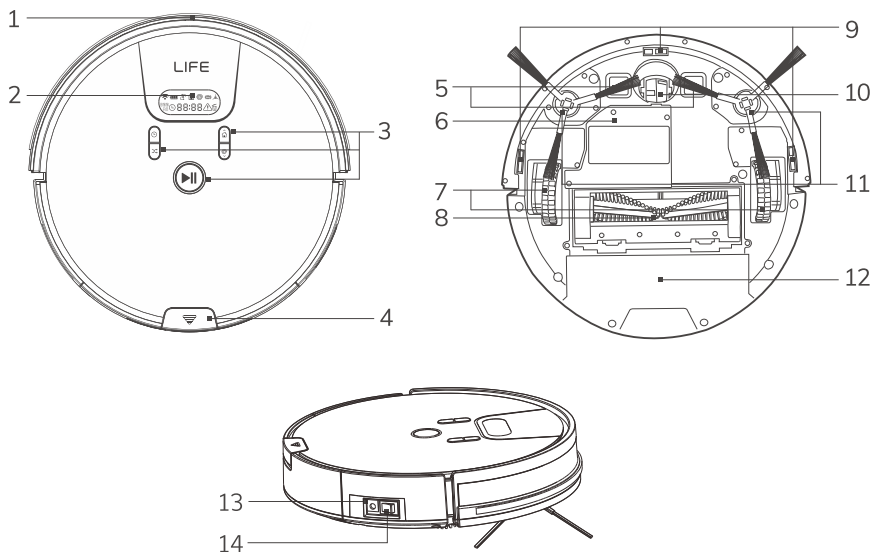

- | | | |
|---------------------------|------------------|-------------------|
| 1. Bumper | 6. Battery cover | 11. Side brushes |
| 2. Signal lights | 7. Side wheels | 12. Dustbin |
| 3. Control panel | 8. Main brush | 13. Power socket |
| 4. Dustbin release button | 9. Cliff sensors | 14. ON/OFF switch |
| 5. Charging pins | 10. Nose wheel | |

Control panel

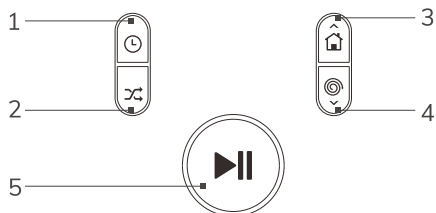

- | |
|--------------------------|
| 1. Schedule |
| 2. Classic mode |
| 3. Charging/Up button |
| 4. Spot Mode/Down button |
| 5. AUTO mode |

Product Parts

Dustbin

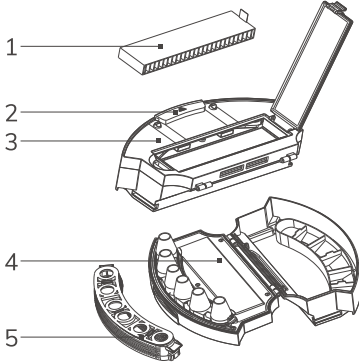

1. High performance filter
2. Dustbin release button
3. Dustbin
4. Dustbin
5. Isolation support

Water tank

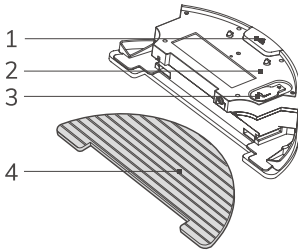

1. Water tank release button
2. Water tank
3. Water inlet
4. Mopping cloth

Remote control

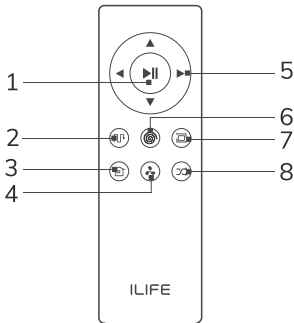

1. Clean/Pause button
2. Path mode
3. Auto charge button
4. MAX mode
5. Direction buttons
6. Spot mode
7. Edge mode
8. Classic mode

How to Use

A80 Pro may miss some complex details in a single scan. Use the robot more often and remove obstacles to help it get familiar with your home every time it scans its surroundings.

Tips for using the robot

The following instructions will help the robot to get familiar with the environment and clean more efficiently.

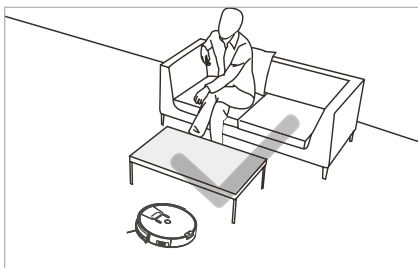

When the robot works for the first time, give it some assistance and remove obstacles on the floor.

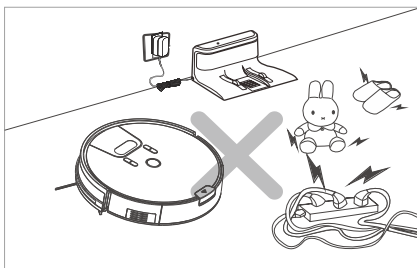

Before cleaning, remove objects on the floor (e.g. power line, toys) that may stumble the robot.

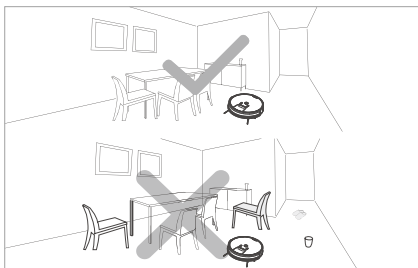

To clean more efficiently, put the furniture and electronic appliances in place.

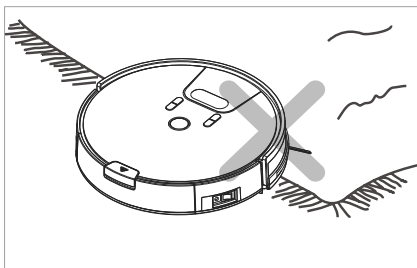

When the robot is cleaning the upper floor of a duplex or a raised platform, make sure no one stands near the stairs to avoid objects falling down the stairs.

How to Use

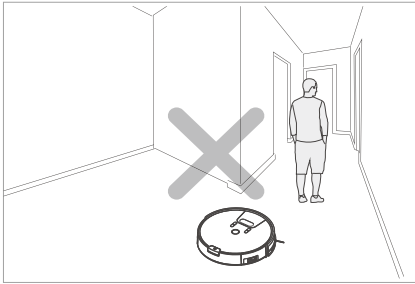

Do not stand near narrow spaces such as thresholds or passageways when the robot is working, or the robot may skip the area.

Quick operation

> Charge preparation

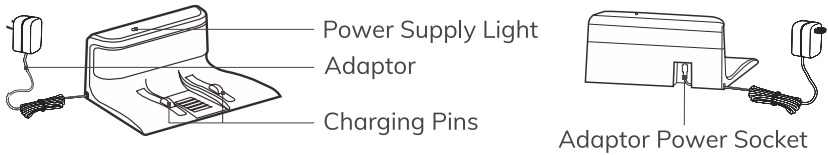

1. Charging dock and power supply

Connect the adaptor with the charging dock. Put the charging dock on a flat surface and against a wall. Remove obstacles about 1 meter on both sides and about 2 meters in front.

Step 1

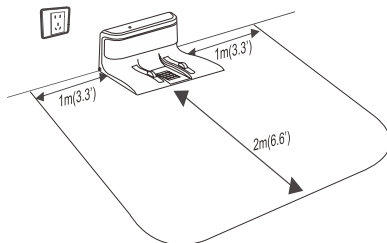

Step 2 Connect to power supply

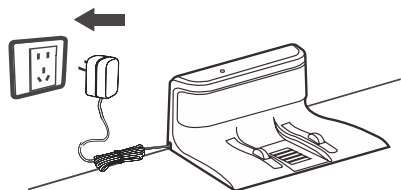

How to Use

! Precautions

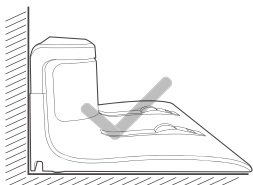

Put the charging dock on a flat surface and against a wall.

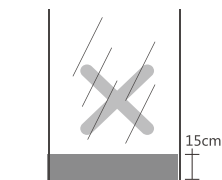

Cover reflective objects (eg. mirror) about 15cm from the floor.

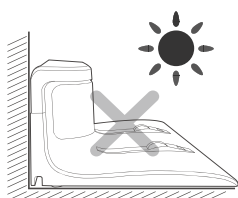

Do not put the charging dock in direct sunlight.



Do not move the charging dock while the robot is working. It may disturb the robot's return route for recharge.

2. Installing side brushes

- Follow the color codes when installing the sides brushes. Make sure both sides are securely installed.

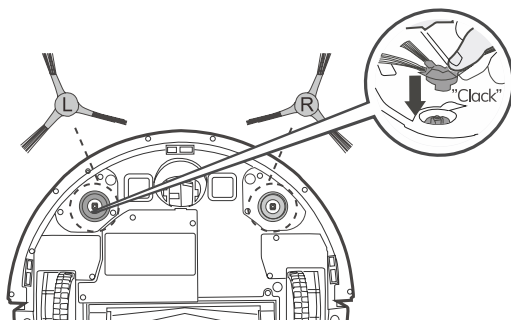

How to Use

> Charging begins

1. Switching on robot

- Turn on the power switch on the side. "—" is to turn on the robot and "O" is to turn off.

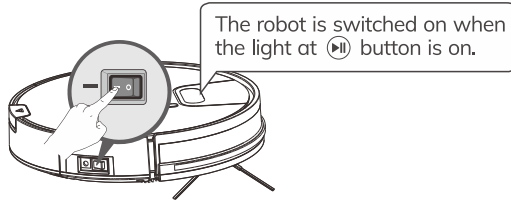

2. Charging

- Put the robot on the charging dock.
- ▶▶ Flashing orange light: Charging in progress.
- ▶▶ Solid green light: Charging completed.
- ▶▶ Light off: In energy-saving sleep mode.

Before first use, put the robot on the charging dock for charging.



Align the charging pads.

! Precautions

Keep the power switch on ("—") while charging.

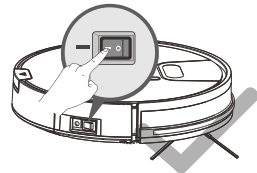

> Start

- Press ▶▶ on the robot remote control. ▶▶ on the robot will flash. AUTO cleaning mode will begin when the light at ▶▶ turns solid.

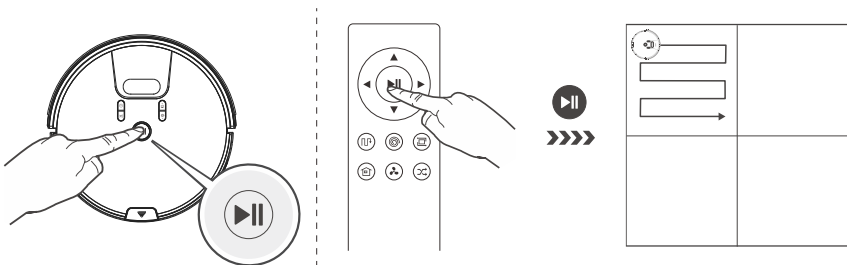



How to Use

> Pause

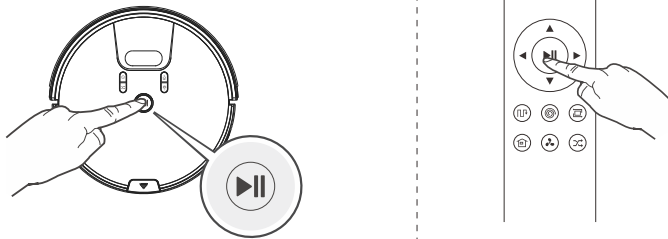
While the robot is working, press  on the robot or remote control to pause the cleaning cycle.



- * Robot will plan a new route after it is paused and restarted. It will repeat cleaning the areas it has covered.
- * Move the robot's position with the remote control when it is paused.
- * Robot will enter sleep mode after idling for 10 minutes, and the light on the robot turned off. To reactivate it, press ,  or  on the remote control. To start cleaning, press any button.

> Switching off the robot

Turn the power switch to "O" after the robot is paused.

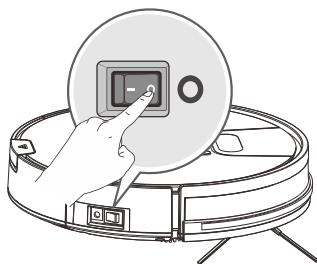





- * To get your robot ready to work anytime, always keep it fully charged by keeping the power switch on after each use.

How to Use



Cleaning modes and functions

The robot comes with several cleaning modes to achieve optimal cleaning performance and better user experience. To select cleaning modes, use the control panel on the robot, remote control or APP.

* When the robot is switched from AUTO mode to another, and returns to AUTO mode after the specific tasks are completed, it will reset a new route that has been covered.



Before setting a cleaning mode, make sure the robot is reactivated (the light at  is on). To reactivate the robot, press ,  or  on the remote control.

> Path mode

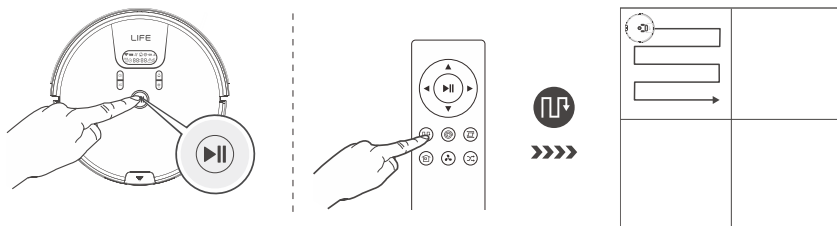
To start Path mode, press  button on the robot or  button on the remote control. The robot will take a S-shaped cleaning route, and approach and clean the areas it has missed during a cleaning cycle.



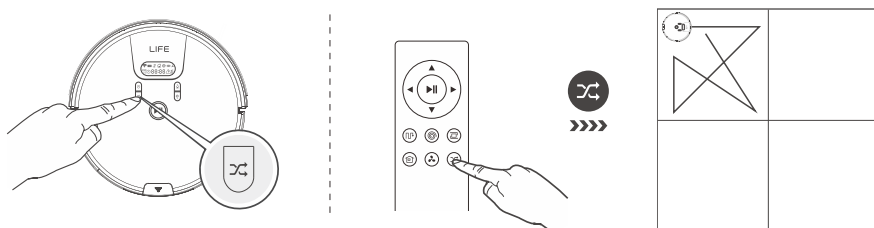

> Classic mode

To start Classic mode, press  button on the robot or  button on the remote control. When the robot finishes cleaning an area in Classic mode, it will move along the walls to the next area. Classic mode is suitable for carpet cleaning.





How to Use

> Spot mode

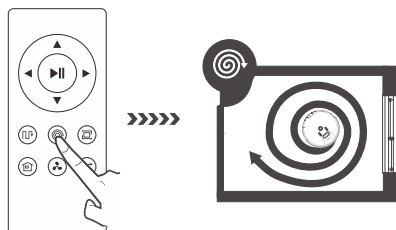
For specific areas that require deep cleaning. Press  button on the robot or  button on the remote control to start Spot mode.



> MAX mode

For areas with concentrated dust and dirt. For increased suction power and deep cleaning, press  button on the robot when it is in AUTO mode. The display will show HI, denoting high suction power. To return to normal suction, press  button again. The display will show LO, denoting low suction power.

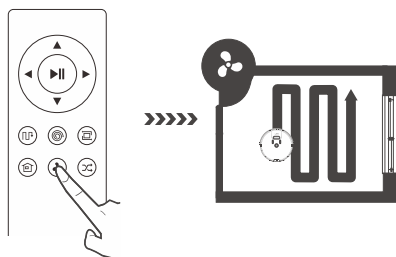

> Edge mode

For the edges and corners of the walls. The robot will clean along the barriers (eg. walls) and return to the charging dock after the task is finished.

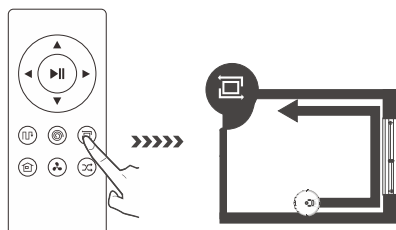

> Self-charging

When the battery runs low, the robot automatically pauses the cleaning cycle and returns to charging dock for recharge.

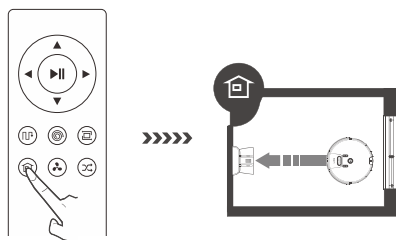

To return the robot to the charging dock for recharge, press  button.

How to Use



Setting a schedule

Set a cleaning schedule for the robot and it will automatically clean your home at a specific time. Before setting a schedule with the APP or control panel on the robot, adjust local time on the robot control panel.

> Setting local time

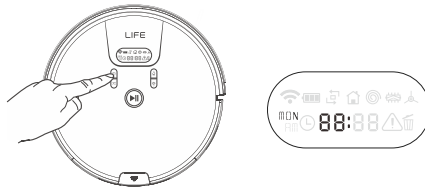
To recover the robot from sleep mode, **press and hold**  button. Set the clock after a beep and when the first two digits on the display flash.



Use  button and  button to adjust the numbers. To adjust local time, use  button to adjust hour, minute, 12/24 hour format and week.

* To adjust the 12/24 hour format, press . The display will show "ON/OFF".

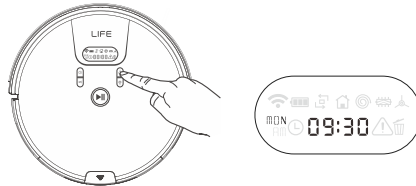

Press  to save the setting.

* The robot will exit the setting after idling for 15 seconds. The setting will not be saved.



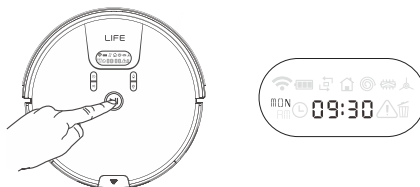

Press  to confirm and save the setting.



How to Use

> Setting a schedule

Method 1:

To reactivate the robot, press the  button. The robot will buzz and the  on the display will flash. As the robot enters schedule mode. Click  to adjust the hour and minute. Press  and  to adjust the numbers and set a schedule.

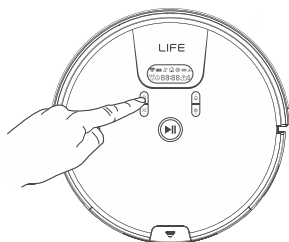



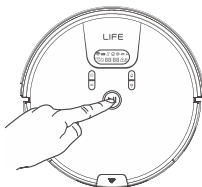

Press  to save the setting. The robot will start cleaning at the scheduled time.

- * The robot will exit the setting after idling for 15 seconds. The setting will not be saved.
- * Press  to confirm and save the setting.



Canceling a schedule

To reactivate the robot, press the  button. The robot will buzz and the  on the display will flash. As the robot enters schedule mode. Click  to cancel the upcoming schedule, and the display will show "--:--". Keep pressing  to activate the upcoming schedule. The display shows the last cleaning schedule. Press the  to save the schedule.

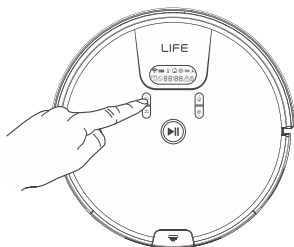

How to Use

Water tank operation

The product is equipped with water tank components, and if there is a demand for the mop, it is recommended to clean the area with the dustbin first. Then change the dustbin to the water tank components to carry out the mop work.



- * If during the mopping process the robot is stopped to either add water or clean the mop, the robot will reset and plan a new pathway from where it is started. In order to achieve a better cleaning, it is recommended for single room use.
- * When cleaning a second room, it is recommended to manually move the robot to the corresponding room and add water and clean the cloth as needed.

- * Please do not use the water tank components on the carpet or rugs. Please fold the edge of the rugs or block carpet areas to avoid cleaning them during the mopping mode during the mopping mode.
- * Please pay attention during the mopping mode, timely add water or clean the mopping pad. The water tank needs to be removed when adding water.
- * Be sure to remove the water tank components when charging.

1 Add water

- Open the water injection cap, fill the water with the water cup, and pour the water slowly into the tank.

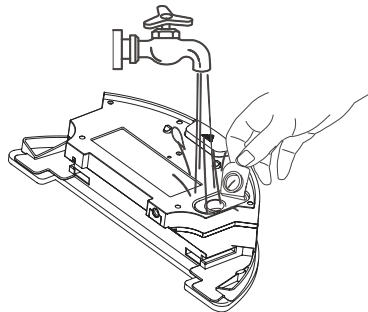

How to Use

2 Place the mop cloth

- Close the water injection cap tightly, put on the mop cloth and strap the two elastic bands.

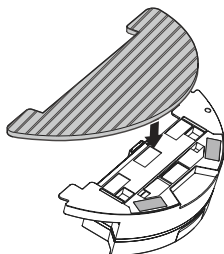

3 Install water tank components

- Press the button at the end of the dustbin, remove the dustbin, and replace it with the water tank components.

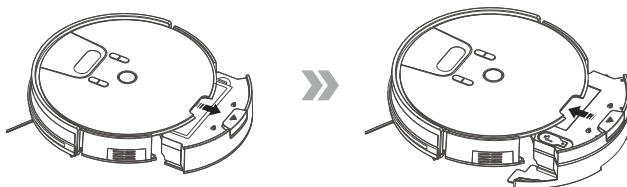

4 Mop the floor

- Start any cleaning mode on demand, and the robot will perform mopping.

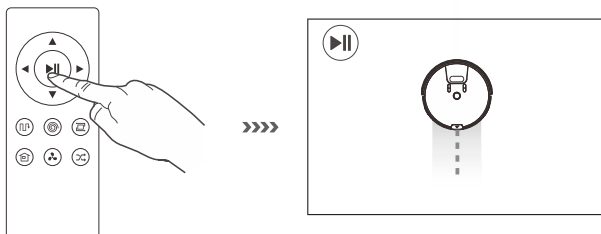

APP Download

The robot can be controlled by the “ILIFEHOME” app. Scan the QR code to install the app on your iOS or Android device.



 ILIFEHOME APP



 ILIFEHOME APP

Maintenance

Switch off the robot and disconnect power supply from the charging dock before maintenance.

Dustbin

Remove the dustbin. Open the cover and empty the content.

1
Step



Remove filters. Tap to remove dust from the high-performance filter. Do not wash with water.

2
Step

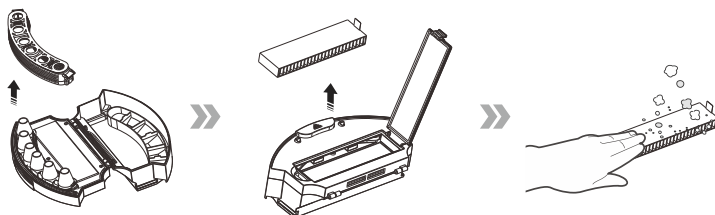

Rinse the dustbin and primary filter.

3
Step

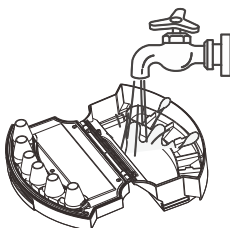

Air-dry the dustbin and filters. Keep them dry to extend their durability.

4
Step

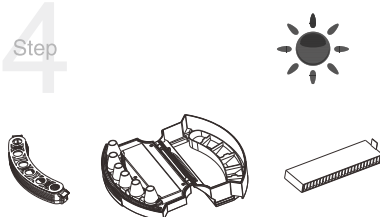

Maintenance

Water tank operation

1 Clean the mop cloth

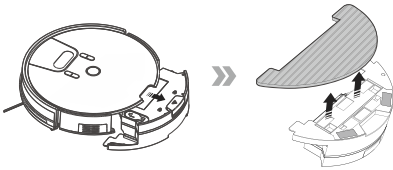

Remove: after mopping, please remove the water tank components and the mop cloth.

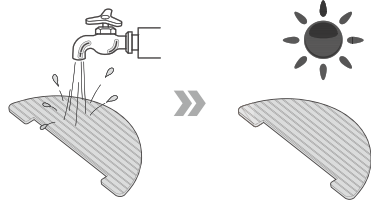

Maintenance: rinse and air dry the mop cloth.

2 Clean the water tank

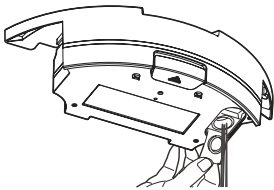

Remove: after mopping, remove the mop cloth and the components, drain the remaining water in the water tank.

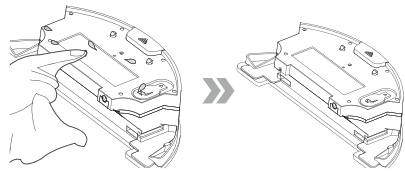

Maintenance: dry the water tank by hand and then air dry it.

Maintenance

Main brush & side brushes

Cleaning main brush

Remove the cover and the brush. Cut the tangles around the brush for easy cleaning.

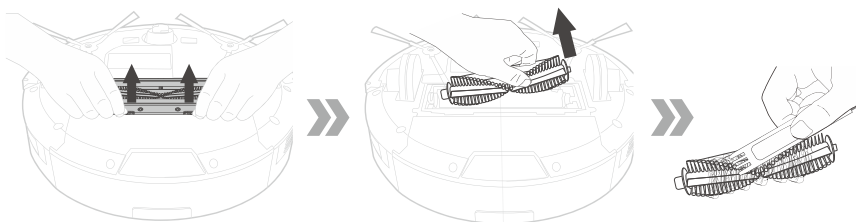

Cleaning side brushes

Remove the brushes. Remove the tangles with the enclosed cleaning tool.

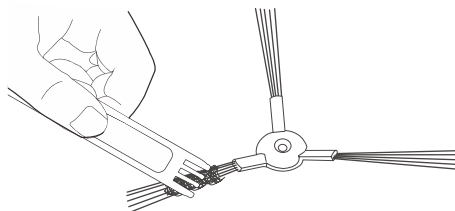

Maintenance

Other parts

Clean the nose wheel with the enclosed cleaning tool.

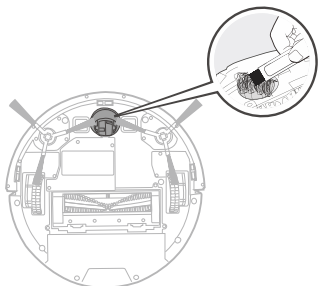

Clean the floor detector to maintain accuracy.

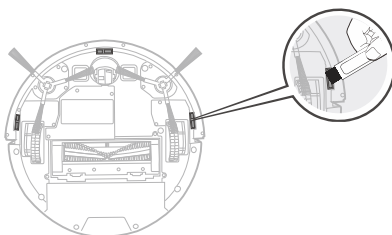

Clean the infrared sensor lens to maintain accuracy.

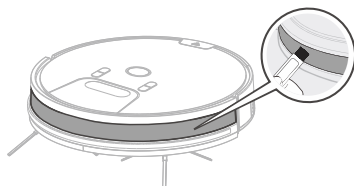



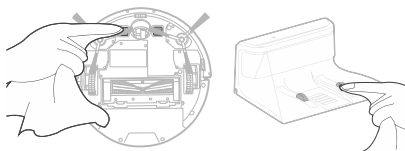















Clean the charging pads on the robot and charging dock with a dry cloth.



- Remove the battery if the robot will not be used for a long time. In case of battery leakage, remove the battery and clean the holder.
- The robot is powered by a long-life battery. Frequent replacement is not necessary. Contact our customer service if you require a new battery.

Alerts

A80 Pro gives different alert sounds if any of its part is not functioning properly. Here are some common problems and solutions:

No	Possible cause	Error code	Alert sound	Solution
01	Left wheel isn't working properly.	E 11 	1 buzz	Check the left wheel.
02	Right wheel isn't working properly.	E 12 	1 buzz	Check the right wheel.
03	Left side brush isn't working properly.	E 13  	1 buzz	Check the left side brush.
04	Right side brush isn't working properly.	E 14  	1 buzz	Check the right side brush.
05	Main brush isn't working properly.	E 15  	1 buzz	Check the main brush.
06	Robot isn't on a flat surface.	E 21 	2 buzz	Put the robot in an open area and restart.
07	Cliff sensor problem.	E 22 	2 buzz	Clean the cliff sensor.
08	Infrared anti-collision sensor problem.	E 23 	2 buzz	Clean the anti-collision sensor.
09	Robot is trapped.	E 31 	3 buzz	Put the robot in an open area and restart.
10	Fan isn't working.	E 32 	3 buzz	Restart the robot. If problem persists, contact our customer service.
11	Battery problem.	E 41 	3 buzz	Replace the battery.
12	Front view sensor isn't working.	E 42 	4 buzz	<ul style="list-style-type: none"> Restart the robot. If problem persists, contact our customer service.
13	Gyro error.	E 43 	5 buzz	<ul style="list-style-type: none"> Restart the robot. If problem persists, contact our customer service.
14	Low battery.	LO 	/	<ul style="list-style-type: none"> Return the robot to the charging dock using the remote control. Always keep the robot fully charged for the next job by leaving it on the charging dock even when it's on standby.
15	Filter is clogged.		/	Clean the filter

Troubleshooting

If you encounter problems when using A80 Pro, find the possible causes and try the solutions below:

No	Symptom	Possible cause	Solution
01	Robot cannot berecharged.	Charging pads on robot and charging dockaren't properly connected.	Make sure the charge pads on robot and charging dock align.
		<ul style="list-style-type: none"> • Charging dock isn't connected to power. • Power is lost if the power switch on robot is turned on. 	Keep the robot's power switch on and put the robot on the charging dock.
02	Robot is stuck	Robot is trapped by cables, curtain or carpet fringes on the floor.	If the robot cannot fix the problems itself, look for voice alert code guide.
03	Robot returns to charging base before it finishes cleaning.	When the battery is running low, robot will return to charging dock for recharge .	Recharge the robot.
		Working time varies on different floors (eg. wood, tile.)	Working time is affected by the complexity of the home setting, amount of debris and chosen cleaning mode.
04	Robot doesn't start cleaning at scheduled time.	Robot is switched off. Robot can't execute a schedule if it's turned off.	Switch robot on.
		Robot's battery is low.	Always leave robot on charging dock even it's on standby to make sure it's fully charged for the next job.
		Robot's parts are clogged or jammed by debris.	Turn off the power switch and clean the dustbin. Turn robot upside down and clean other parts.
05	Remote control isn't working within 5 meters.	Battery in remote control is low.	Replace batteries and install them correctly.
		Robot's power switch is turned off or battery is low.	Make sure robot's power switch is turned on and robot is fully charged.
		Signal reception is affected by dusty infrared transmitter of the remote control or the receiver of robot.	Clean the remote control's infrared transmitter and the robot's receiver with a clean cotton.
		There is interferences caused by other equipment generating infrared signals around the remote control.	Avoid using other infrared equipment near the remote control.

Product Specifications

Classification	Item	Detail
Mechanical specifications	Diameter	330mm
	Height	80mm
	Weight	2.6kg
Electrical specifications	Power	22W
	Battery specifications	Li-ion
Cleaning specifications	Dustbin capacity	0.45L
	Water tank capacity	0.3L
	Charging type	Auto charging / Manual charging
	Cleaning mode	Auto, Spot, Edge, Daily schedule
	Cleaning time	Up to 100min
Main body button type		Mechanical button

