

EH1635BE, EH1645BE, EH1745BE,
EH1955BE, EH1977BE

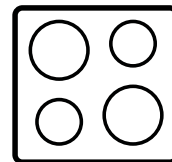

Induction hob

Installation & User manual

Enjoy peace of mind. Register your appliance today.

Stay updated on better living services,
safety notices and shop for accessories.

1. **Open the camera app on your smartphone and point at the QR code to scan.**

Product Registration QR code is located on the top surface or underside of your appliance.

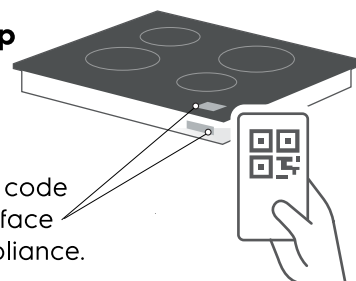

2. **Tap the notification or link to open the registration form.**

3. **Complete your details and enjoy peace of mind.**

CONGRATULATIONS

Thank you for purchasing an Electrolux cooktop. You've chosen a product that brings with it decades of professional experience and innovation. Ingenious and stylish, it has been designed with you in mind. So whenever you use it, you can be safe in the knowledge that you'll get great results every time.

Welcome to Electrolux.

BEFORE USING YOUR APPLIANCE

Check for any damage or marks. If you find the appliance damaged or marked you must report it within 7 days to claim for damages under the manufacturers warranty.

Before you use the appliance, we recommend that you read through the whole user manual which provides the description of the product and its functions. To avoid the risks that are always present when you use a gas appliance, it is important that the product is installed correctly and that you read the safety instructions carefully to avoid misuse and hazards.

For future reference, please store this booklet in a safe place.

This appliance complies with the requirements of Australian Standard AS 4551 & AS/NZS 60335.2.6.

CONDITIONS OF USE

This appliance is intended to be used in household and similar applications such as:

- Staff kitchen areas in shops, offices and other working environments
- Farm houses
- By clients in hotel/motel rooms and other residential type environments
- Bed and breakfast type environments.

BEFORE YOU CALL

Please ensure you read the instruction manual fully before you call for service, or a full service fee could be applicable.

Record model and serial number here:

Model number: _____

Serial number: _____

CONTENTS

Safety information	3
Product description	5
Operating instructions	12
Helpful hints and tips.....	21
Care and cleaning	26
Troubleshooting.....	27
Installation	29
Technical information	30
Environment	31
Notes	32
Warranty	33

SYMBOLS



WARNING!

This symbol indicates information concerning your personal safety.



CAUTION!

This symbol indicates information on how to avoid damaging the appliance.



IMPORTANT!

This symbol indicates tips and information about use of the appliance.



ENVIRONMENT!

This symbol indicates tips and information about economical and ecological use of the appliance.

IMPORTANT INFORMATION THAT MAY IMPACT YOUR MANUFACTURER'S WARRANTY

Adherence to the directions for use in this manual is extremely important for health and safety. Failure to strictly adhere to the requirements in this manual may result in personal injury, property damage and affect your ability to make a claim under the Electrolux manufacturer's warranty provided with your product. Products must be used, installed and operated in accordance with this manual. You may not be able to claim on the Electrolux manufacturer's warranty in the event that your product fault is due to failure to adhere this manual.

SAFETY INFORMATION

Please read the user manual carefully and store in a handy place for later reference. Pass the user manual on to possible new owners of the appliance.

Read the following carefully to avoid damage or injury.

NOTE: You must read these warnings carefully before installing or using the appliance. If you need assistance, contact your Customer Care Department. The manufacturer will not accept liability, should these instructions or any other safety instructions incorporated in this book be ignored.

Children and vulnerable people safety



WARNING!

Risk of suffocation, injury or permanent disability.

- Do not let children or persons with reduced physical, sensory, mental functions or lack of experience use the appliance. They must have supervision or instruction for the operation of the appliance by a person who is responsible for their safety.
- Do not let children play with the appliance.
- Keep all packaging away from children.
- Keep children and pets away from the appliance when it operates or when it cools down. Accessible parts are hot.
- If the appliance has a child safety device, we recommend that you activate it.

Installation



WARNING!

Only a qualified person must install this appliance.

- Remove all the packaging.
- Do not install or use a damaged appliance.
- Obey the installation instruction supplied with the appliance.
- Keep the minimum distance from the other appliances and units.
- Always be careful when you move the appliance because it is heavy. Always wear safety gloves.
- Seal the cut surfaces with a sealant to prevent moisture causing swelling.
- Protect the bottom of the appliance from steam and moisture.
- Do not install the appliance adjacent to a door or under a window. This prevents hot cookware to fall from the appliance when the door or the window is opened.
- If the appliance is installed above drawers make sure that the space, between the bottom of the appliance and the upper drawer, is sufficient for air circulation.

- The bottom of the appliance can get hot. We recommend to install a non-combustible separation panel under the appliance to prevent access to the bottom.

Use



WARNING!

Risk of injury, burns or electric shock.

- Use this appliance in a household environment.
- Do not change the specification of this appliance.
- Do not use an external timer or a separate remote-control system to operate the appliance.
- Do not let the appliance stay unattended during operation.
- Do not operate the appliance with wet hands or when it has contact with water.
- Do not put cutlery or saucepan lids on the cooking zones. They can become hot.
- Set the cooking zone to "off" after each use. Do not rely on the pan detector.
- Do not use the appliance as a work surface or as a storage surface.
- If there is a crack on the surface, disconnect power supply to prevent the electrical shock.
- Users with a pacemaker must keep a distance of minimum 30cm from the induction cooking zones when the appliance is in operation.



WARNING!

Risk of fire or explosion.

- Fats and oil when heated can release flammable vapours. Keep flames or heated objects away from fats and oils when you cook with them.
- The vapours that very hot oil releases can cause spontaneous combustion.
- Used oil, that can contain food remnants, can cause fire at a lower temperature than oil used for

SAFETY INFORMATION

the first time.

- Do not put flammable products or items that are wet with flammable products in, near or on the appliance.
- Do not try to extinguish a fire with water. Disconnect the appliance and cover the flame with a lid or a fire blanket.



WARNING!

Risk of damage to the appliance.

- The glass ceramic can be damaged by objects falling onto it.
- The edge of the glass ceramic can be damaged by being knocked by the cookware.
- Cookware made of cast iron, cast aluminium or with damaged bottoms can scratch the glass ceramic if pushed across the surface.
- Before spillage can become burnt on to the cooking surface, remove it with a damp cloth.
- To avoid damaging cookware and glass ceramics, do not allow saucepans or frying pans to boil dry.
- Do not use the cooking zones with empty cookware or without cookware.
- Do not let cookware boil dry to prevent damage to cookware and the ceramic glass.
- Do not cover the parts of the appliance with aluminium foil.

NOTE: Damage including broken glass or scratches caused by misuse outlined above is not covered under warranty.

Care and cleaning



WARNING!

Risk of damage to the appliance.

- Regularly clean the appliance to prevent the deterioration of the surface material.
- Do not use water spray and steam to clean the appliance.
- Clean the appliance with a moist soft cloth. Only use neutral detergents. Do not use abrasive products, abrasive cleaning pads, solvents or metal objects.

Disposal



WARNING!

Risk of injury or suffocation.

- Disconnect the appliance from the mains supply.
- Cut off the mains cable and discard it.

PRODUCT DESCRIPTION

EHI635BE

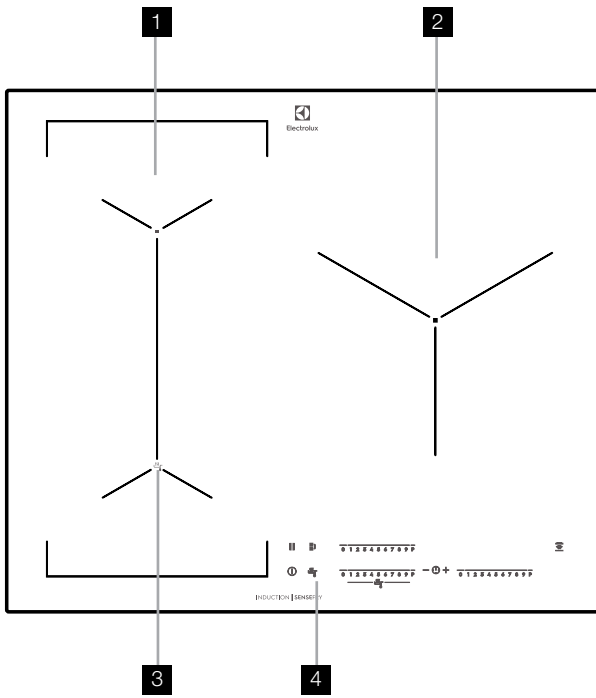

EHI645BE

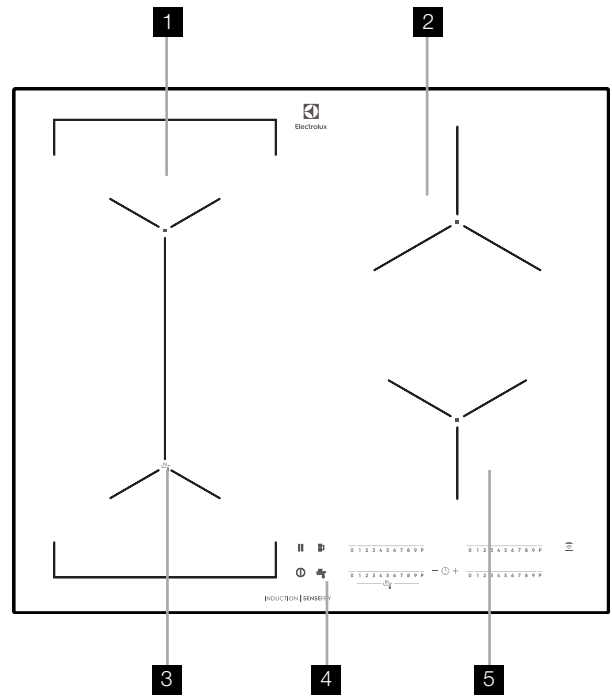

EHI745BE

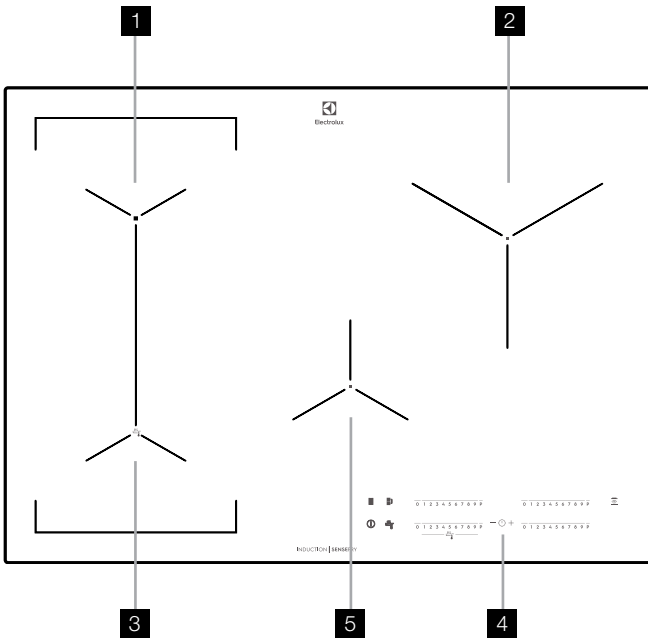

- 1** Induction cooking zone
- 2** Induction cooking zone
- 3** Induction cooking zone
- 4** Control panel
- 5** Induction cooking zone

PRODUCT DESCRIPTION (CONTINUED)

EHI955BE

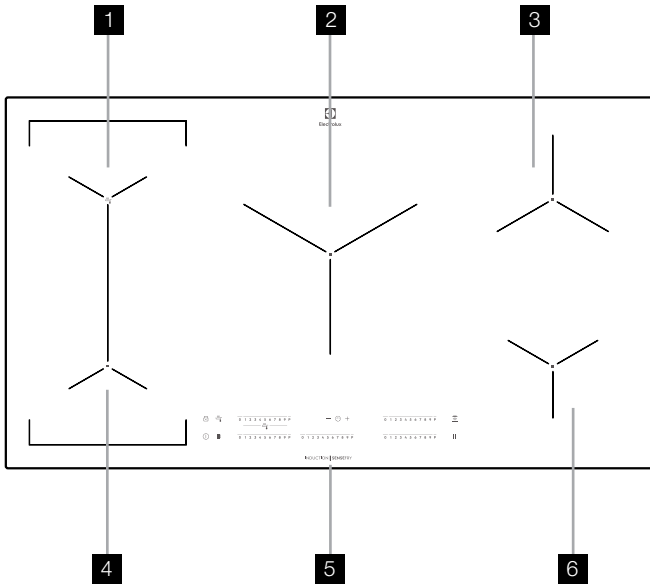

EHI977BE

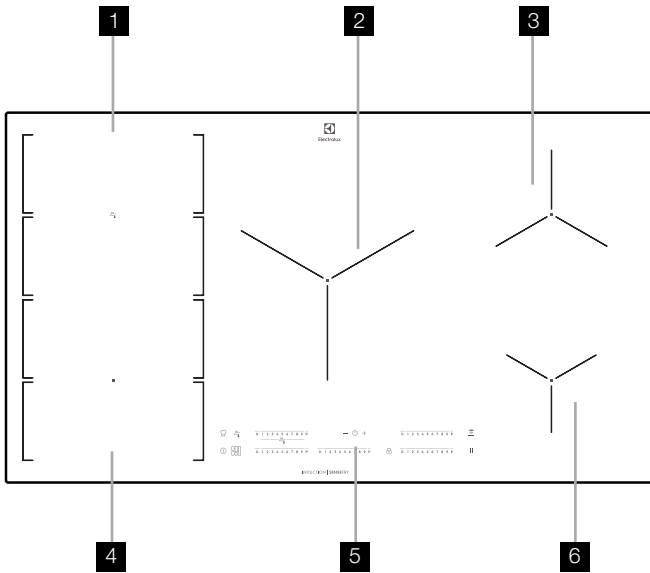

- 1** Induction cooking zone
- 2** Induction cooking zone
- 3** Induction cooking zone
- 4** Induction cooking zone
- 5** Control panel
- 6** Induction cooking zone

Control panel layouts

EHI635BE

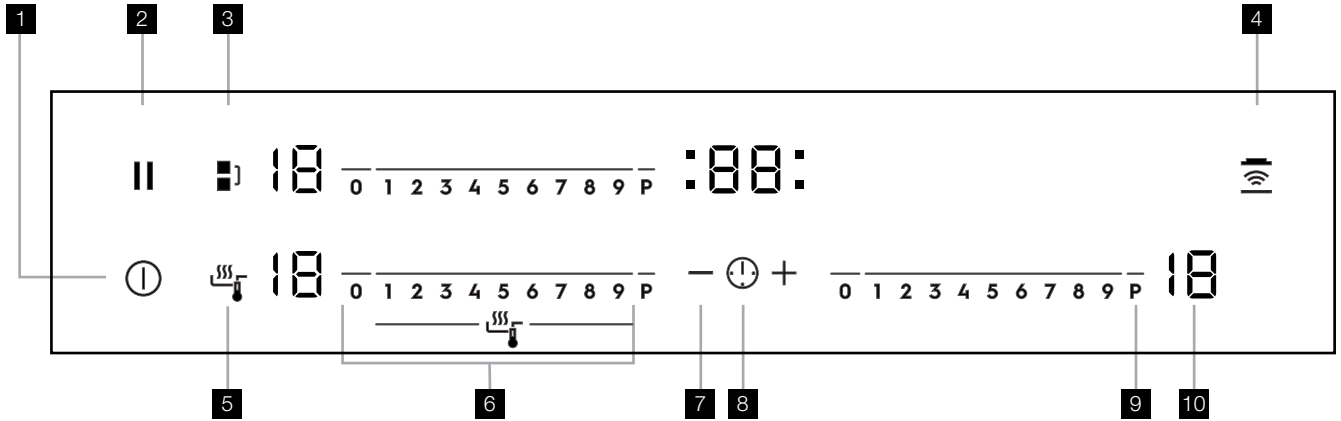

EHI645BE

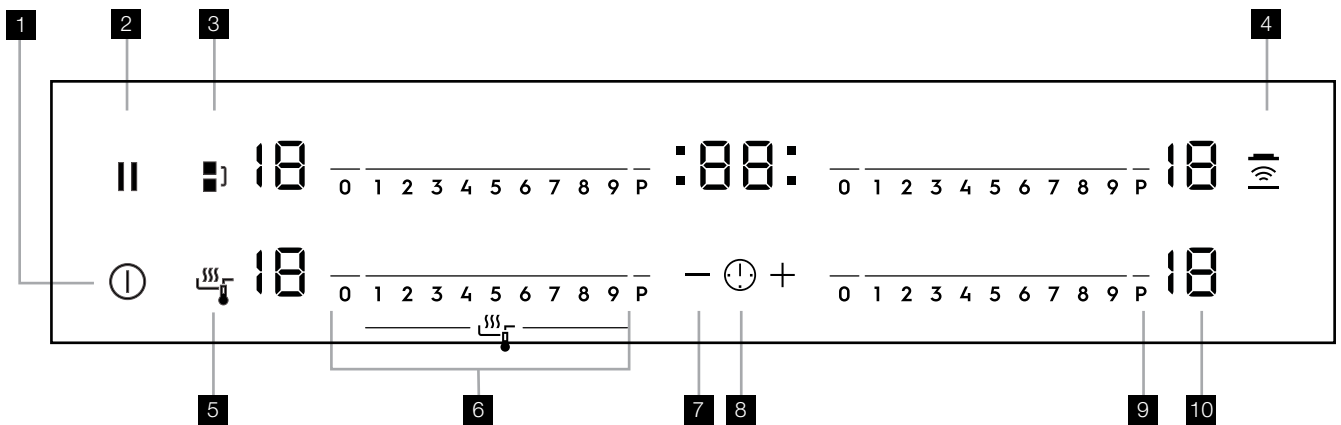

	Sensor field	Function
1	ⓘ	To activate and deactivate the appliance
2		To lock / unlock the control panel Sets all operating zones to a keep warm setting
3	■	To activate the Bridge function
4	⊗	To activate and deactivate the manual mode of the Hob2Hood function.
5	☼	To activate the Sensefry function
6	Control bar	To set a heat setting
7	+ / -	To increase or decrease the time
8	⌚	To set the timer function
9	P	To activate the Power function
10	A heat setting display	To show the heat setting

PRODUCT DESCRIPTION (CONTINUED)

Control panel layouts

EHI745BE

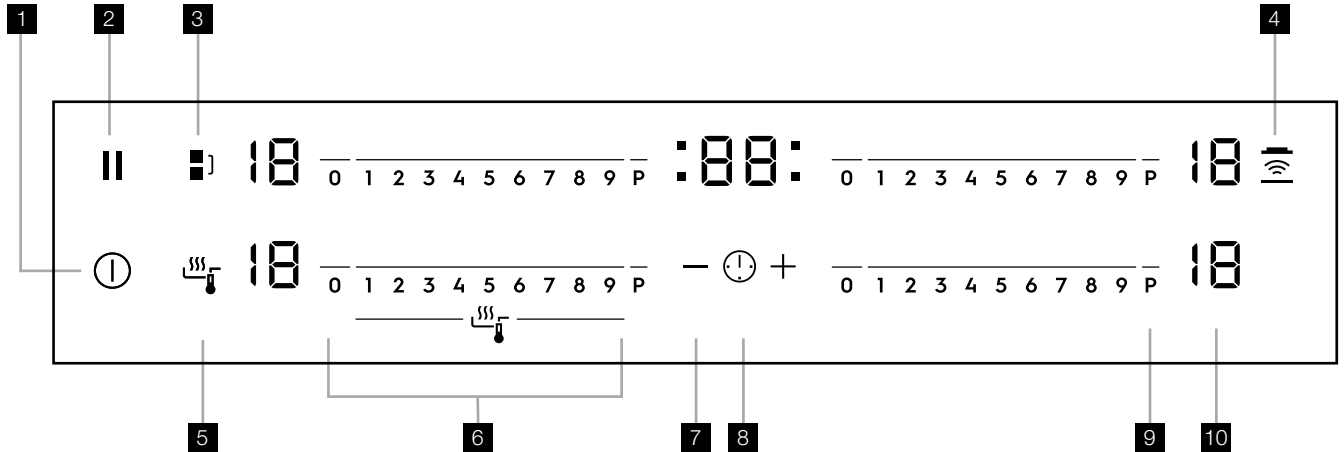

	Sensor field	Function
1	ⓘ	To activate and deactivate the appliance
2		To lock / unlock the control panel Sets all operating zones to a keep warm setting
3	⏏	To activate the Bridge function
4	Ⓜ	To activate and deactivate the manual mode of the Hob2Hood function.
5	🍳	To activate the Sensefry function
6	Control bar	To set a heat setting
7	+ / -	To increase or decrease the time
8	ⓘ	To set the timer function
9	P	To activate the Power function
10	A heat setting display	To show the heat setting

Control panel layouts

EHI955BE

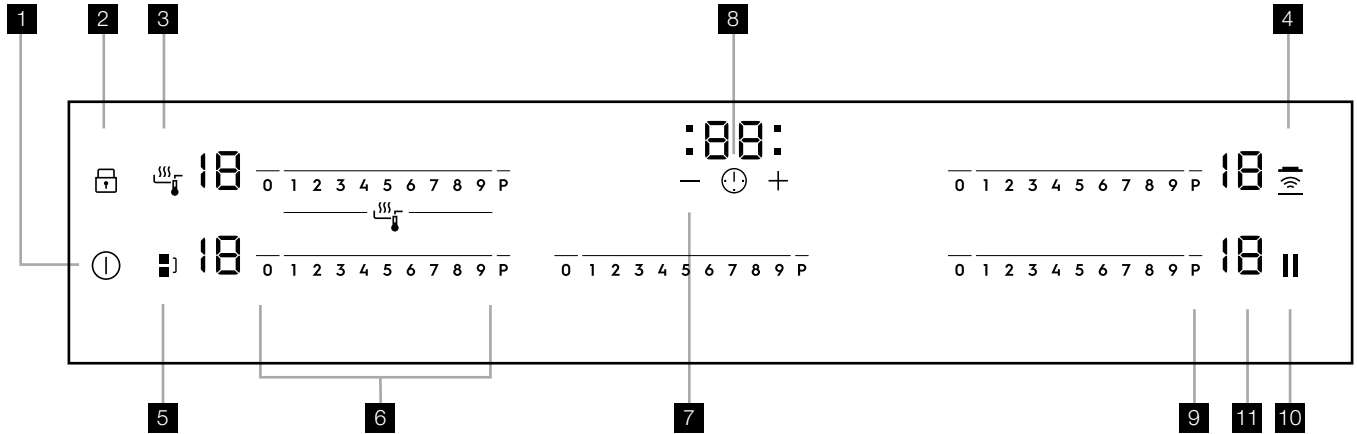

	Sensor field	Function
1	ⓘ	To activate and deactivate the appliance
2	🔒	To lock / unlock the control panel
3	🔥	To activate the Sensefry function
4	📶	To activate and deactivate the manual mode of the Hob2Hood function.
5	🔗	To activate the Bridge function
6	Control bar	To set a heat setting
7	+ / -	To increase or decrease the time
8	🕒	To set the timer function
9	P	To activate the Power function
10		Sets all operating zones to a keep warm setting
11	A heat setting display	To show the heat setting

PRODUCT DESCRIPTION (CONTINUED)





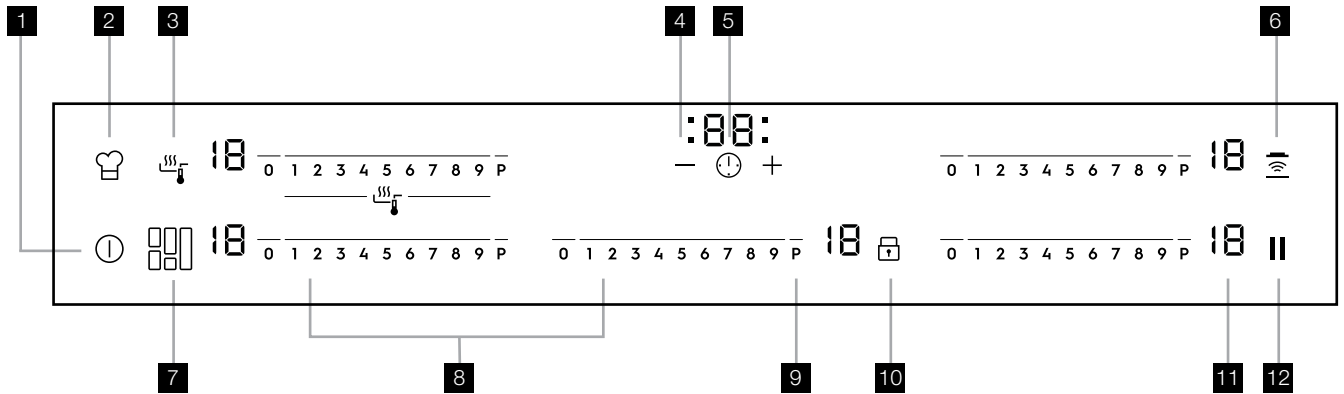





Control panel layouts

EHI977BE



	Sensor field	Function
1	ⓘ	To activate and deactivate the appliance
2	👨‍🍳	To activate the chef function
3	👨‍🍳	To activate the Sensefry function
4	+ / -	To increase or decrease the time
5	🕒	To set the timer function
6	📶	To activate and deactivate the manual mode of the Hob ² Hood function.
7	🔧	To switch between the modes of the function
8	Control bar	To set a heat setting
9	P	To activate the Power function
10	🔒	To lock / unlock the control panel
11	A heat setting display	To show the heat setting
12		Sets all operating zones to a keep warm setting

Heat setting displays

Display	Description
	The cooking zone is deactivated
 - 	The cooking zone operates
	Sets all operating zones to a keep warm setting
	The automatic heat up function operates
	Power function operates
 + digit	There is a malfunction
 / = / -	OptiHeat Control (3 step Residual heat indicator) : continue cook / stay warm / residual heat
	Lock / The child safety function operates
	Not correct cookware or too small or no cookware on the cooking zone
	The automatic switch off function operates

OptiHeat control (3 step residual heat indicator)

WARNING!

/ = / - **Risk of burns from residual heat!**

OptiHeat Control shows the level of the residual heat. The induction cooking zones make the heat necessary for cooking directly in the bottom of the cookware. The glass ceramic is hot from the heat of the cookware.

OPERATING INSTRUCTIONS

On and off

Touch **1** for 1 second to activate or deactivate the appliance.

Automatic switch off

The function deactivates the appliance automatically if:

- All cooking zones are deactivated (**0**).
- You do not set the heat setting after you activate the appliance.
- You spill something or put something on the control panel for more than 10 seconds, (a pan, a cloth, etc). An acoustic signal sounds after some time and the appliance deactivates. Remove the object or clean the control panel.
- The appliance becomes too hot (e.g. when a saucepan boils dry). Before you use the appliance again, wait for the cooking zone to cool down.
- You use incorrect cookware. The symbol **F** comes on and the cooking zone deactivates automatically after 2 minutes.
- You do not deactivate a cooking zone or change the heat setting. After some time **0** comes on and the appliance deactivates. See the table below.

Automatic switch off times

Heat setting	0 - 1 - 2	3 - 4	5	6 - 9
Stops after	6 hours	5 hours	4 hours	1.5 hours

The heat setting

Touch the control bar at the heat setting. Change to the left or the right, if it is necessary. Do not release before you have a correct heat setting. The display shows the heat setting.

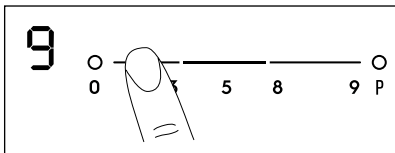

Bridge function

i **IMPORTANT!**

Use the Bridge Function with the Infinite Plancha accessory¹⁾.

The Bridge Function connects the two left side cooking zones under the accessory and they operate as one. First set the heat setting for one of the cooking zones.

To activate the Bridge Function, touch **1**. To set or change the heat setting, touch one of the control sensors. To deactivate the Bridge Function, touch **1**. The cooking zones operate independently.

Automatic heat up

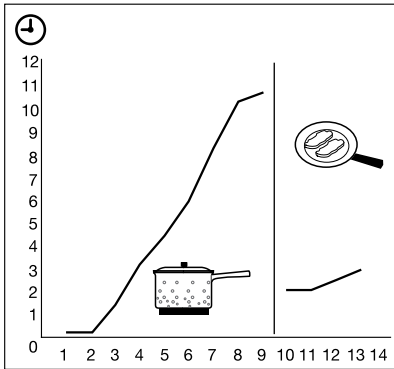

You can get a necessary heat setting in a shorter time if you activate the Automatic Heat Up function. This function sets the highest heat setting for some time (see the graphic), and then decreases to the necessary heat setting. To start the Automatic Heat Up function for a cooking zone:

1. Touch **P** (**P** comes on in the display).
2. Immediately touch the necessary heat setting. After 3 seconds **R** comes on in the display. To stop the function change the heat setting.

Switching on and off the power function

The Power function makes more power available to the induction cooking zones. The Power function is activated for 5 minutes at most. After that the induction cooking zone automatically switches back to heat setting **9**. To switch on, touch **P**, **P** comes on. To switch off, touch a heat setting between **1** and **9**.

Count down timer

Use the Count Down Timer to set how long the cooking zone operates for one cooking session. **Set the Count Down Timer after the selection of the cooking zone.** You can set the heat setting before or after you set the timer.

- To set the cooking zone: touch **⌚** again and again until the indicator of the required cooking zone comes on.
- Starting the Count Down Timer: touch **+** of the timer to set the time (**00** - **99** minutes). When the indicator of the cooking zone flashes slower, the time counts down.
- Checking the remaining time: select the cooking zone with **⌚**. The indicator of the cooking zone flashes faster. Display shows the remaining time.
- Changing the Count Down Timer: select the cooking zone with **⌚** touch **+** or **-**.
- Stopping the timer: select the cooking zone with **⌚**. Touch **-**. The remaining time counts backwards to **00**. The indicator of the cooking zone goes out. To switch off you can also touch **+** and **-** at the same time.
- When the time elapses, the sound operates and **00** flashes. The cooking zone switches off.
- Stopping the sound: touch **⌚**.

Minute minder

You can use the timer as a Minute Minder while cooking zones are not operating. Touch **⌚**. Touch **+** or **-** of the timer to select the time. When the time elapses, the sound operates and **00** flashes.

- Stopping the sound: touch **⌚**.

OPERATING INSTRUCTIONS (CONTINUED)

Keep warm

The **II** function sets all cooking zones that operate to the lowest heat setting (**II**). When **II** operates, you cannot change the heat setting.

II does not stop the timer function.

- To activate this function touch **II**. **II** comes on.
- To deactivate this function touch **II**. The heat setting that you set before comes on.

Lock

When the cooking zones operate, you can lock the control panel, but not **⏻**. It prevents an accidental change of the heat setting. First set the heat setting. To start this function touch **II** or **🔒**. The symbol **🔒** comes on for 4 seconds. The Timer stays on. To stop this function touch **II** or **🔒**. The heat setting that you set before comes on. When you stop the appliance, you also stop this function.

The child safety device

This function prevents an accidental operation of the hob.

Starting the child safety device:

- Start the hob with **⏻**. Do not set the heat settings.
- Touch **II** or **🔒** for 4 seconds. The symbol **🔒** comes on.
- Stop the hob with **⏻**.

Switching off the child safety device:

- Start the hob with **⏻**. Do not set the heat settings. Touch **II** or **🔒** for 4 seconds. The symbol **🔒** comes on.
- Stop the hob with **⏻**.

Overriding the child safety device for one cooking session:

- Start the hob with **⏻**. The symbol **🔒** comes on.
- Touch **II** or **🔒** for 4 seconds. Set the heat setting in less than 10 seconds. You can operate the hob.
- When you stop the hob with **⏻**, the child safety device operates again.

Hob²Hood

This is an advanced automatic function which connects the hob to a special hood. Both the hob and the hood have an infra-red signal communicator. Speed of the fan is defined automatically on basis of mode setting and temperature of the hottest cookware on the hob. You can also operate the fan from the hob manually.

i IMPORTANT!

For most of the hoods the remote system is originally deactivated. Activate it before you use the function. For more information refer to hood user manual.

Operating the function automatically

The default automatic mode from the factory is H5. You can change the automatic mode by following the instructions below. When you activate the hob the hood will adjust the fan speed automatically. Please note the below table is a guide, the fan speed varies depending on the temperature measured on the cooking zones of the cooktop which can be affected by the heat setting(s) selected as well as the size and volume of what you are cooking.

Automatic modes

	Automatic light	Boiling	Frying
Mode H0	Off	Off	Off
Mode H1	On	Off	Off
Mode H2	On	Fan speed 1	Fan speed 1
Mode H3	On	Off	Fan speed 1
Mode H4	On	Fan speed 1	Fan speed 1
Mode H5	On	Fan speed 1	Fan speed 2
Mode H6	On	Fan speed 2	Fan speed 3

1. The hob detects the boiling process and activates fan speed in accordance with automatic mode.
2. The hob detects the frying process and activates fan speed in accordance with automatic mode.
3. This mode activates the fan and the light and does not rely on the temperature.

Changing the automatic mode

1. Deactivate the appliance.
2. Touch **⏻** for 3 seconds. The display comes on and goes off
3. Touch **🔒** for 3 seconds.
4. Touch **⏻** a few times until **🔒** comes on.
5. Touch **+** of the Timer to select an automatic mode.

i IMPORTANT!

To operate the hood directly on the hood panel deactivate the automatic mode of the function.

When you finish cooking and deactivate the hob, the hood fan may still operate for a certain period of time. After that time the system deactivates the fan automatically and prevents you from accidental activation of the fan for the next 30 seconds.

Flexible Induction Cooking Area

WARNING!

Refer to Safety chapters.

FlexiBridge function

The flexible induction cooking area consists of four sections. The sections can be combined into two cooking zones with different size, or into one large cooking area. You choose the combination of the sections by choosing the mode applicable to the size of the cookware you want to use. There are three modes: Standard (activated automatically when you activate the hob), Big Bridge and Max Bridge.

IMPORTANT!

To set the heat settings, use the two left side control bars.

Switching between the modes

To switch between the modes use sensor field: 

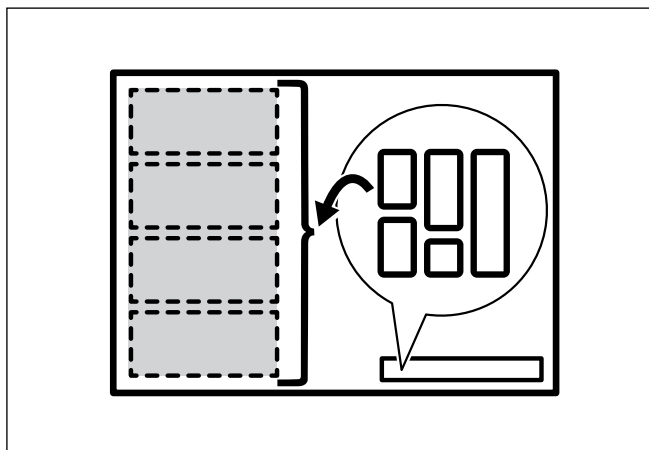

IMPORTANT!

When you switch between the modes the heat setting is set back to **0**.

Diameter and position of the cookware

Choose the mode applicable to the size and the shape of the cookware. The cookware should cover the selected area as much as possible. Place the cookware centrally on the selected area!

Place any cookware with bottom diameter smaller than 160 mm centrally on a single section.

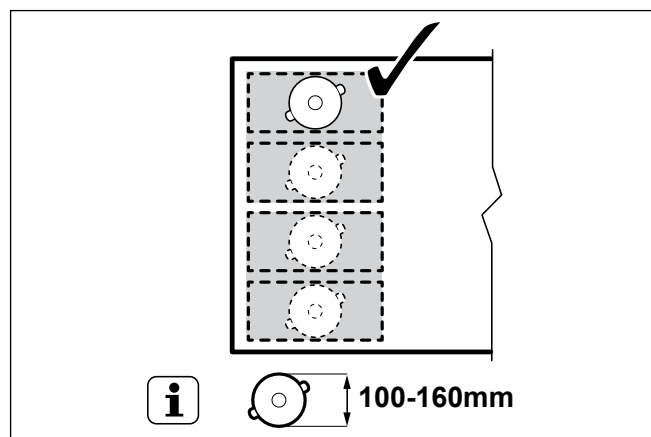

Place any cookware with bottom diameter larger than 160 mm centrally between two sections.

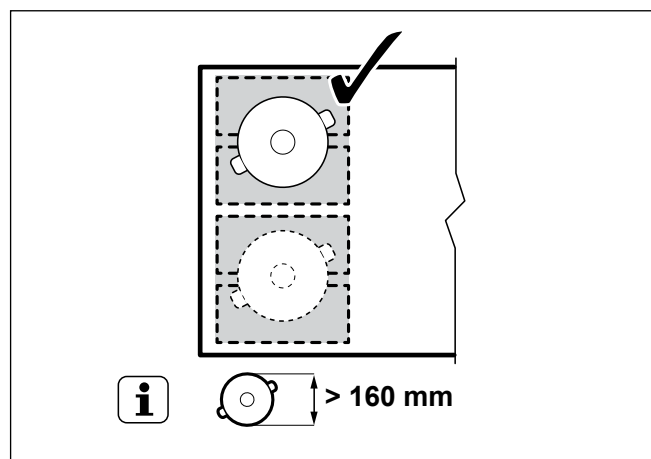

FlexiBridge standard mode

This mode is active when you activate the hob. It connects the sections into two separate cooking zones. You can set the heat setting for each zone separately. Use two left side control bars.

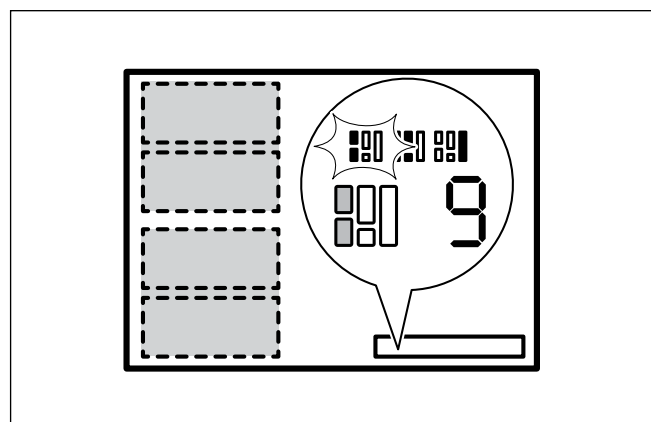

OPERATING INSTRUCTIONS (CONTINUED)

Power management

All cooking zones are connected to one phase.
See the illustrations.

- The function activates when the total electricity loading of the cooking zones exceeds maximum electricity loading of the phase.
- The function divides the power between cooking zones.
- The function decreases the power of the other cooking zones.
- The heat setting display of the reduced zones alternates between the chosen heat setting and the reduced heat setting. After some time the heat setting display of the reduced zones stays on the reduced heat setting.

Power management with Power limitation

The power management divides the power between two cooking zones in a pair (see the illustration). The power function increases the power to the maximum level for one cooking zone in the pair. The power in the second cooking zone automatically decreases. The heat setting display for the reduced zone changes between two levels. Only for EHI645BE/EHI745BE

The power management divides the power in all cooking zones (see the illustration). The power function increases the power to the maximum level for one cooking zone. The power in the first active cooking zone automatically decreases. The heat setting display for the reduced zone changes between two levels.

Only for EHI635BE/EHI955BE/EHI977BE

EHI645BE

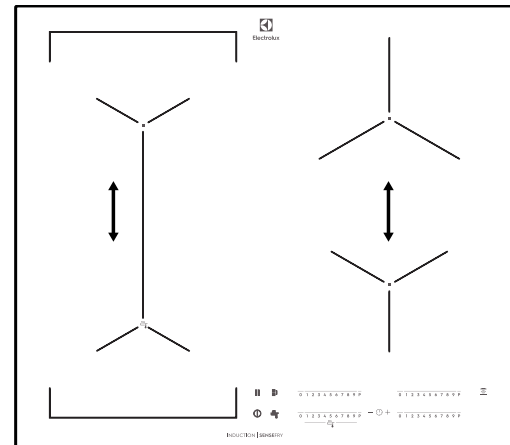

EHI745BE

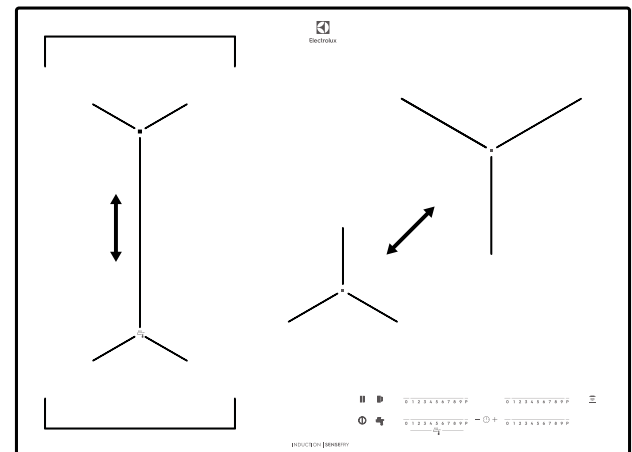

EHI635BE

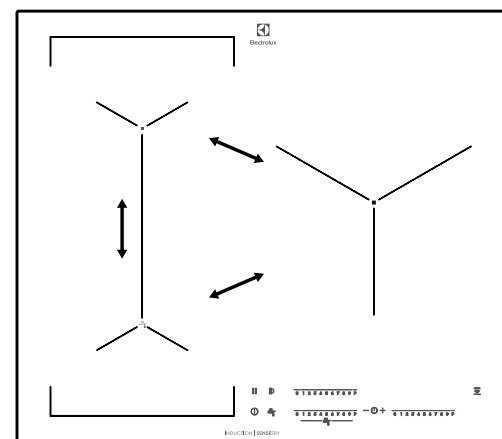

EHI955BE

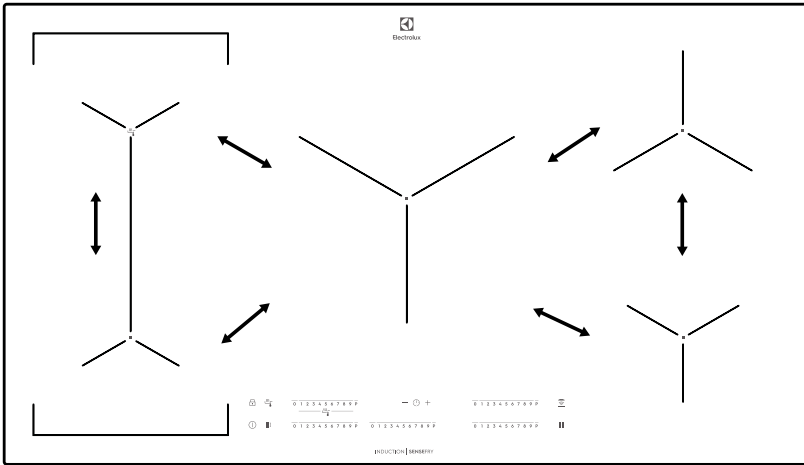

EHI977BE

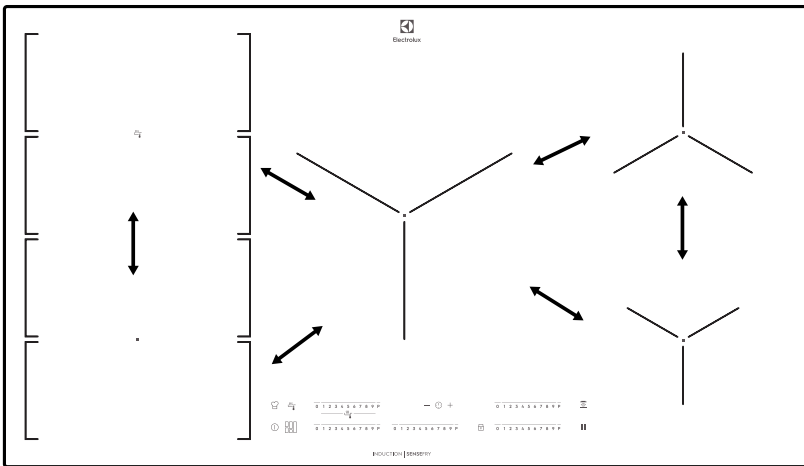

OPERATING INSTRUCTIONS (CONTINUED)

Correct cookware position:

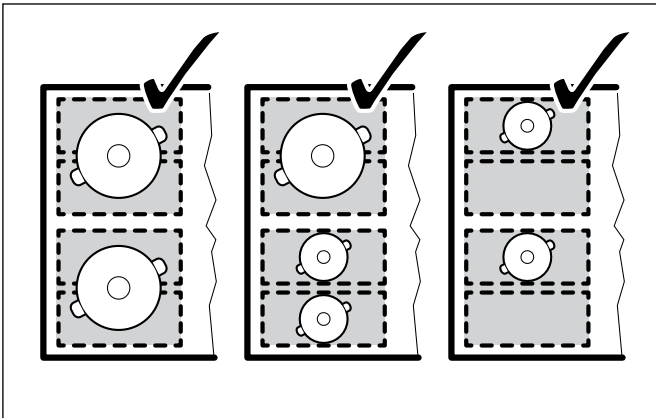

Incorrect cookware position:

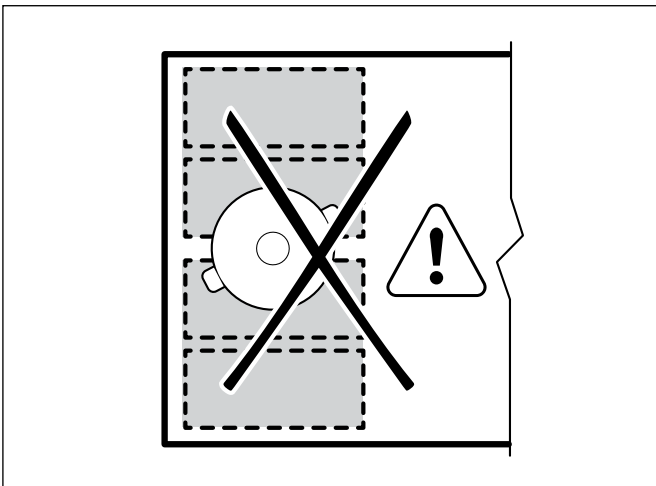

FlexiBridge big bridge mode

To activate the mode press  until you see the correct mode indicator. This mode connects three rear sections into one cooking zone. The one front section is not connected and operates as a separate cooking zone. You can set the heat setting for each zone separately. Use two left side control bars.

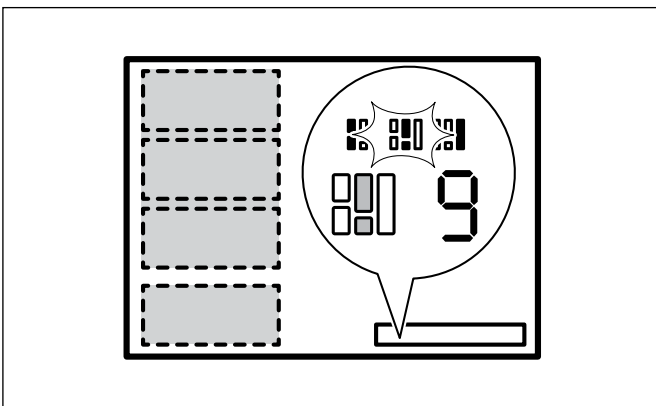

Correct cookware position:

To use this mode you have to place the cookware on the three connected sections. If you use cookware smaller than two sections the display shows  and after 2 minutes the zone switches off.

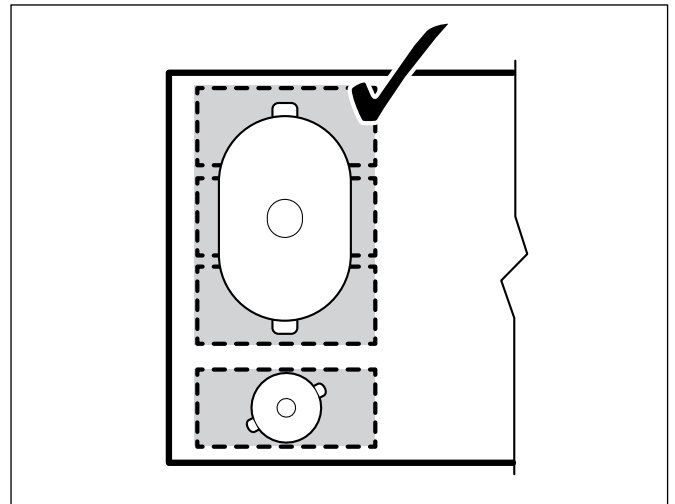

Incorrect cookware position:

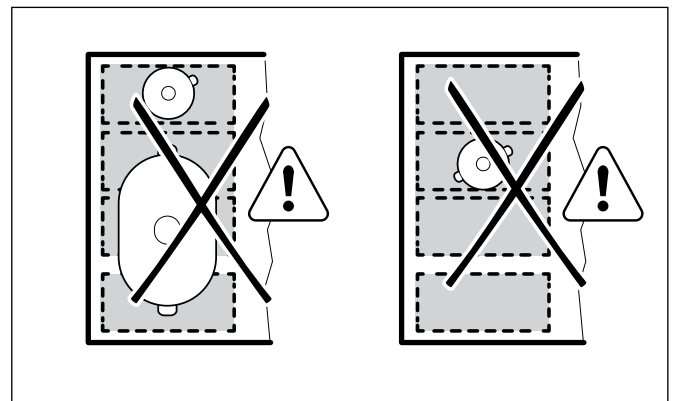

FlexiBridge max bridge mode

To activate the mode press  until you see the correct mode indicator. This mode connects all sections into one cooking zone. To set the heat setting use one of the left side control bars.

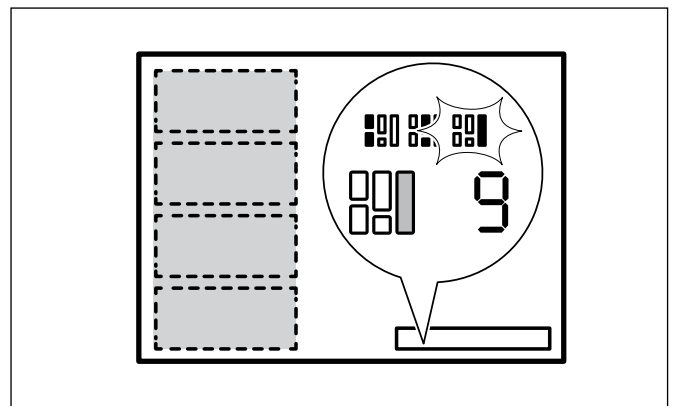

Correct cookware position:

To use this mode you have to place the cookware on the four connected sections. If you use cookware smaller than three sections the display shows **F** and after 2 minutes the zone switches off.

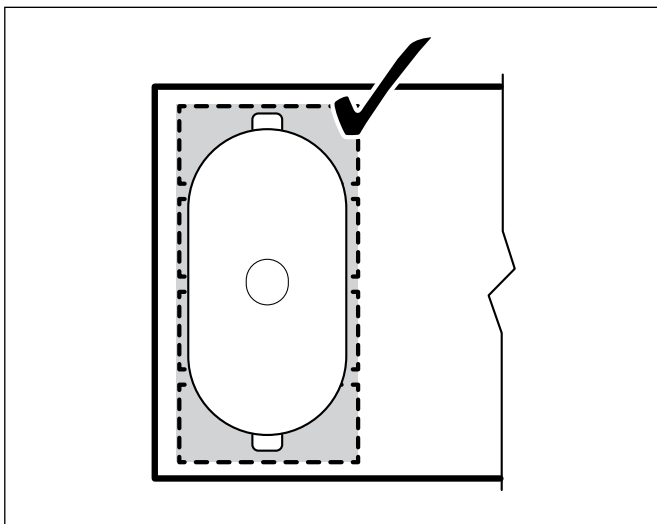

Incorrect cookware position:

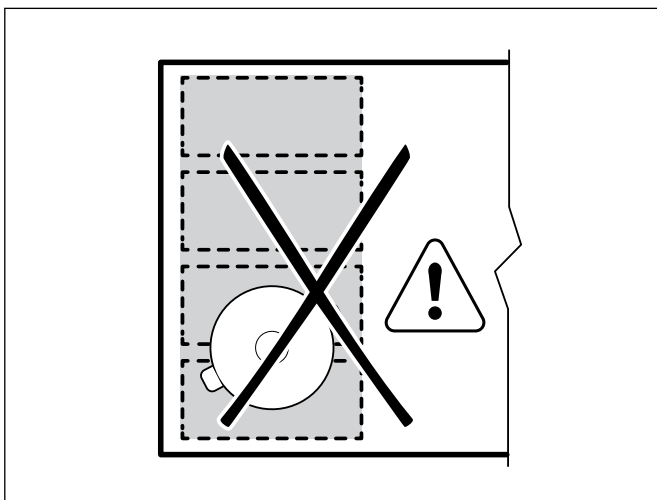

Powerslide Function

This function allows you to adjust the temperature by moving the cookware to a different position on the induction cooking area.

The function divides the induction cooking area into three areas with different heat settings. The hob senses the position of the cookware and sets the heat setting corresponding with the position. You can place the cookware in the front, middle or rear position. If you place the cookware in the front you get the highest heat setting. You can decrease the heat setting by moving the cookware in the middle or to the rear position.

i IMPORTANT!

Use only one pot when you operate the function.

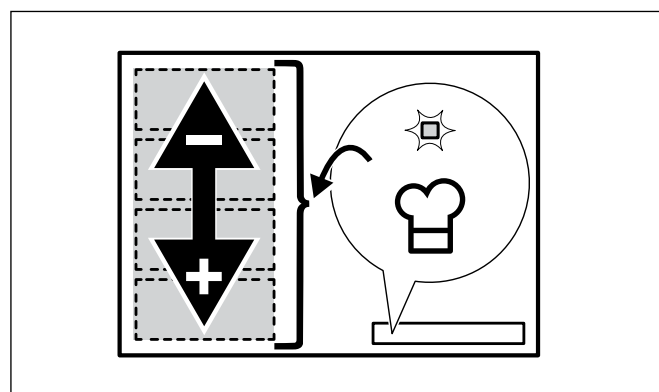

General information

- 160 mm is the minimum bottom diameter of the cookware for this function.
- Heat setting display for the left rear control bar shows the position of the cookware on the induction cooking area. Front **1**, middle **2**, rear **3**.

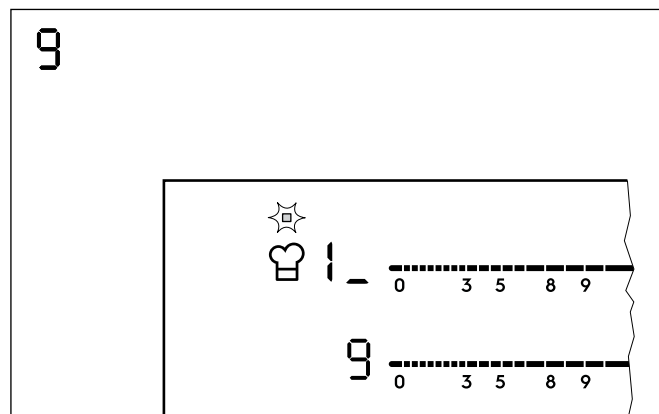

- Heat setting display for the left front control bar shows the heat setting. **To change the heat setting use left front control bar.**

OPERATING INSTRUCTIONS (CONTINUED)

- When you activate the function for the first time you will get heat setting **9** for the front position, **6** for the middle position and **3** for the rear position.

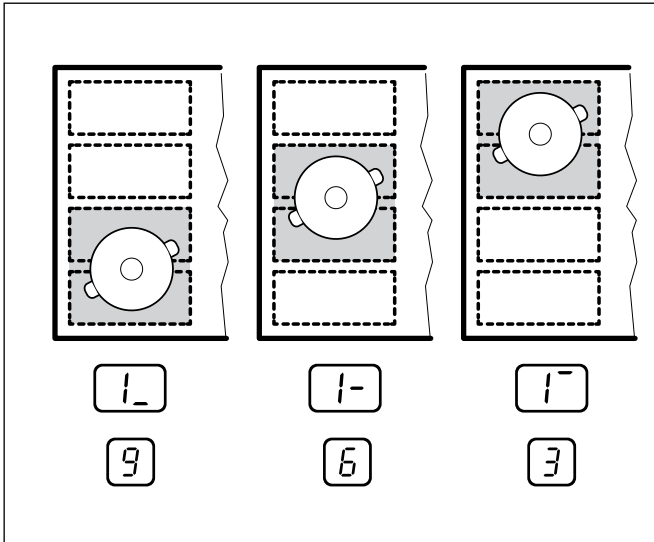

You can change the heat settings for each position separately. The hob will remember your heat settings next time you activate the function.

Activating the function

To activate the function place the cookware in the correct position on the cooking area. Touch . The indicator above the symbol comes on. If you do not place the cookware on the cooking area **F** comes on and after 2 minutes the flexible induction cooking area is set to **0**.

Deactivating the function

To deactivate the function touch or set the heat setting to **0**. The indicator above the symbol goes off.

SenseFry function

This function lets you set a heat setting level to fry your food. The hob keeps the selected temperature automatically while frying. Once the heat setting level is set, no manual temperature adjustment is necessary.

To activate the function:

- Put an empty pan on the left front cooking zone. Do not use a lid while using the function.
- Press . The indicator above the symbol comes on. The heat setting is set to **1**.
- Set the best heat setting for the food you want to fry. Refer to the table in Hints and tips chapter. The indicators above the symbol start to flash slowly. The zone is heating up.
- Wait until the pan reaches the temperature you set. A signal sounds. All indicators above the symbol are on.
- Put the food and some fat on the pan.

To deactivate the function:

Touch **0** of the left front cooking zone or touch .

IMPORTANT

You can set the function for the left front cooking zone of the hob. Only for EHI635BE/EHI645BE/EHI745BE.





You can set the function for the left rear cooking zone of the hob only for EHI955BE/EHI977BE

CAUTION!

Use laminated pans only with low heat setting level to prevent overheating and damage of the cookware.

HELPFUL HINTS AND TIPS

Operating the fan speed manually

You can also operate the function manually. To do that touch  when the hob is active. This deactivates automatic operation of the function and allows you to change the fan speed manually. When you press  you raise the fan speed by one. When you reach an intensive level and press  again you will set fan speed to 0 which deactivates the hood fan. To start the fan again with fan speed 1 touch .

IMPORTANT!

To activate automatic operation of the function, deactivate the hob and activate it again.

Activating the light

You can set the hob to activate the light automatically whenever you activate the hob. To do so set the automatic mode to H1 – H6.

IMPORTANT!

The light on the hood deactivates 2 minutes after deactivating the hob.

IMPORTANT

INDUCTION COOKING ZONES

For induction cooking zones a strong electro-magnetic field creates the heat in the cookware very quickly.

Cookware for induction cooking zones

WARNING!

Use the induction cooking zones with correct cookware.

Cookware material:

- correct: cast iron, steel, enamelled steel, stainless steel, the bottom made of multi-layer (with 'induction-ready' mark from the manufacturer).



- not correct: aluminium, copper, brass, glass, ceramic, porcelain.

Cookware is correct for an induction hob if:

- some water boils very quickly on a zone set to the highest heat setting.
- a magnet pulls on to the bottom of the cookware.

Cookware is correct for an induction hob if:

Find the right cookware

Only magnetic pots and pans work with induction. Check to see if your cookware is compatible: Place a magnet on the bottom of your pot or pan - if it clings firmly, the cookware will work with your cooktop. Choose the right size pot or pan for the right cooking zone.



✓ MAGNET STICKS

Cookware base material has good magnetic characteristics.



✗ MAGNET FALLS

Cookware base material is non-magnetic.

- some water boils very quickly on a zone set to the highest heat setting.
- a magnet pulls on to the bottom of the cookware.

IMPORTANT!

The bottom of the cookware must be as thick and flat as possible.

Use of the cooking zones

IMPORTANT!

Put the cookware on the cross which is on the surface that you cook. Cover the cross fully. The magnetic part of the bottom of the cookware must be 125mm minimum. Induction cooking zones adapt to the dimension of the bottom of the cookware automatically. You can cook with the large cookware on two cooking zones at the same time.

HELPFUL HINTS AND TIPS (CONTINUED)

The noises during operation

If you can hear:

- crack noise: cookware is made of different materials (Sandwich construction).
- whistle sound: you are using one or more cooking zones with high power levels and the cookware is made of different materials (Sandwich construction).
- humming: you are using high power levels.
- clicking: electric switching is occurring.
- hissing, buzzing: the fan is operating.

The noises are normal and do not refer to any defects.

If unfamiliar with induction units please first compare the operating sounds of a demonstration model at your retailer before calling service. If a service call is placed and the sounds are normal you will be charged for the visit.

Energy saving



ENVIRONMENT

HOW TO SAVE ENERGY

- If it is possible, always put the lids on the cookware.
- Put cookware on a cooking zone before you start it.
- Use the residual heat to keep the food warm or to melt it.



IMPORTANT!

THE COOKING ZONE EFFICIENCY

The cooking zone efficiency is related to the diameter of the cookware. The cookware with a smaller diameter than the minimum receives only a part of the power generated by the cooking zone. For the minimum diameters see the Technical data chapter.

Hints and Tips for Hob²Hood function

When you operate the hob with Hob²Hood function:

- Protect the hood panel from direct sunlight.
- Do not spot halogen light on the hood panel.
- Do not cover the hob panel.
- Do not interrupt the signal between the hob and the hood (for example with a hand or a cookware handle). (Hood in the picture is only an example).

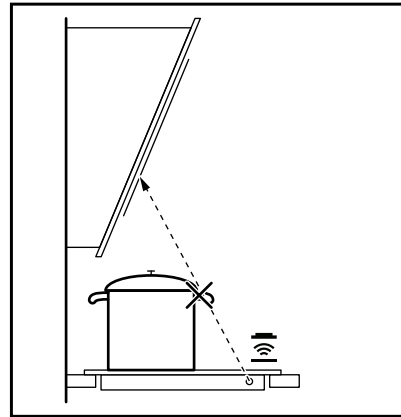

IMPORTANT!

It may happen that other remote controlled appliances may block the signal. To avoid it do not operate the remote of the appliance and the hob at the same time.

Rangehoods with the Hob²Hood function

To find the full range of rangehoods which work with this function refer to our consumer website. The Electrolux rangehoods that work with this function must have the symbol .

Examples of cooking applications

The relation between the heat setting and the cooking zone consumption of power is not linear. When you increase the heat setting it is not proportional to the increase of the cooking zone consumption of power.

It means that the cooking zone with the medium heat setting uses less than a half of its power.

IMPORTANT

The data in the table is for guidance only.

Heat setting	Use to:	Time	Hints	Nominal power consumption
⏸ 1	Keep cooked foods warm	as required	Cover	3%
1-2	Hollandaise sauce, melt: butter, chocolate, gelatine	5 - 25 min	Mix occasionally	3-8%
1-2	Solidify: fluffy omelettes, baked eggs	10 - 40 min	Cook with a lid on	3-8%
3	Simmer rice and milk based dishes, heating up ready-cooked meals	25 - 50 min	Add at least twice as much liquid as rice, stir milk dishes part way through	8-13%
4	Steam vegetables, fish, meat	20 - 45 min	Add some tablespoons of liquid	13-18%
5	Steam potatoes	20 - 60 min	Use max. 1/4 L water for 750 g of potatoes	18-25%
5	Cook larger quantities of food, stews and soups	60 - 150 min	Up to 3 L liquid plus ingredients	18-25%
6-7	Gentle fry: escalope, veal cordon bleu, cutlets, rissoles, sausages, liver, roux, eggs, pancakes, doughnuts	as necessary	Turn halfway through	25-45%
7-8	Heavy fry, hash browns, loin steaks, steaks	5 - 15 min	Turn halfway through	45-64%
9	Boil large quantities of water, cook pasta, sear meat (goulash, pot roast), deep fry chips			100%
P	Boil large quantities of water. Power management is activated.			

The Power function is suitable for heating large quantities of water.

Information on acrylamides

Important! According to the newest scientific knowledge, if you brown food (especially food that contains starch), acrylamides can pose a health risk. Thus, we recommend that you cook at the lowest temperatures and do not brown food too much.

HELPFUL HINTS AND TIPS (CONTINUED)

Hints and Tips for Sensefry function

To achieve the best results with the function:

- Start the function when the hob is cold (no manual heat up of the cookware is necessary).
- Use cookware made of stainless steel with sandwich bottom.
- Do not use cookware with embossment at the center of the bottom.

Examples of cooking applications for the function

The data in the tables shows examples of food for each heat setting level. The amount, thickness, quality and temperature (i.e. frozen) of the food have an influence on the correct heat setting level. Choose the heat setting level and adjustment that are the best for your cooking habits and pans.

Eggs heat setting level	Heat setting level
Omlette, fried eggs	1 - 3
Scrambled eggs	4 - 6

Fish	Heat setting level
Filet of fish, fish fingers, seafood	4 - 6

Meat	Heat setting level
Cutlet, chicken breast, turkey breast	1 - 3
Hamburger, meatball	2 - 4
Escalope, filet, steak medium / well done, fried sausages, minced meat	4 - 6
Steak rare	7 - 9

Vegetables	Heat setting level
Fried potatoes, raw	1 - 3
Fried potatoes patty	4 - 6
Vegetables	4 - 6

i IMPORTANT!

Different sizes of pans can cause different heat up times. Heavy pans store more heat than the light pans but take more time to heat up.

Correct pans for Fry Assist function

Use only pans with flat bottom. To check if the pan is correct:

1. Put your pan upside down.
2. Put a ruler on the bottom of the pan.
3. Try to put a 5 cent coin or something with similar thickness between the ruler and base of the pan

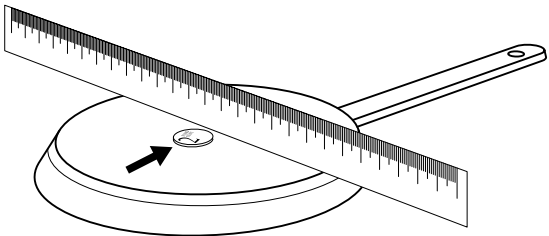

- a. The pan is incorrect if you can put the coin between the ruler and the pan.

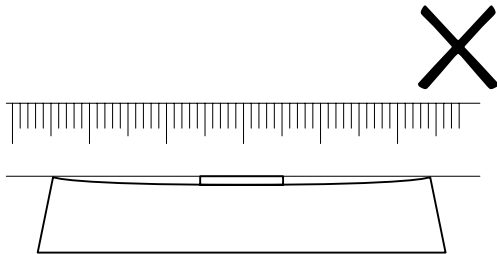

CARE AND CLEANING

**Clean the appliance after each use.
Always use cookware with clean bottom.**

i IMPORTANT

Scratches or dark stains on the glass ceramic have no effect on how the appliance operates.

To remove the dirt

1. **Remove immediately:** melted plastic, plastic foil, and food with sugar. If not, the residue can cause damage to the appliance. Use a cooktop scraper that is specially designed for use on ceramic glass. Put the scraper on the glass surface at an acute angle and move the blade on the surface.

2. **Remove after the appliance is sufficiently cool:** limescale rings, water rings, fat, stains, shiny metallic discolourations. Use a special cleaning agent for glass ceramic or stainless steel.
3. Clean the appliance with a moist cloth and some detergent.
4. At the end rub the appliance dry with a clean cloth.



If the deposit is minimal, simply wipe off with a dry cloth.

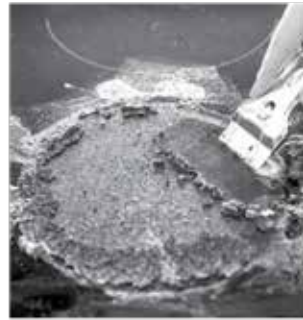

If the deposit does not clean off with any of the above mentioned methods, use a razor blade scraper, specially designed for glass-ceramic cooktops.



If the deposit is more important, clean off with a moist, soapy sponge and rinse off.



Having successfully cleaned the cooktop, apply a glass ceramic cooktop conditioner which will protect the cooktop surface against any future stains, with a dry cloth or equivalent.









If the deposit does not clean off easily, use a non-abrasive scratch pad and a specially adapted glass-ceramic cleaning product

TROUBLESHOOTING

TROUBLESHOOTING

Problem	Possible cause	Remedy
Red rings, limescale or water rings, shiny metallic or other discolouration, scratches/shadows, bubbles or other miscellaneous marks or stains on ceramic glass cooktop surface.	Cooktop surface has not been cleaned correctly. Cleaning/ maintenance of the cooktop surface is not covered under warranty. If a service call is placed to clean the cooktop you will be charged for the visit.	Use a ceramic glass cleaner such as Cerapol.
Pitting of ceramic glass surface.	Spillovers of liquid with high sugar content.	These types of spills must be removed immediately with a special scraper for the glass. If not permanent damage to the cooktop glass can occur which is not covered under warranty.
You cannot activate the appliance or operate it.	<ul style="list-style-type: none"> You touched 2 or more sensor fields at the same time. The keep warm function operates. There is water or fat stains on the control panel. 	<p>Activate the appliance again and set the heat setting in less than 10 seconds.</p> <p>Touch only one sensor field.</p> <p>Refer to the chapter "Operating instructions"</p> <p>Clean the control panel.</p>
An acoustic signal sounds and the appliance deactivates. An acoustic signal sounds when the appliance is deactivated.	You put something on one or more sensor fields.	Remove the object from the sensor fields.
The appliance deactivates.	You put something on the sensor field.	Remove the object from the sensor field.
The residual heat indicator does not come on.	The cooking zone is not hot because it operated only for a short time.	If the cooking zone operated sufficiently long to be hot, speak to the service centre.
The Automatic Heat Up function does not operate.	<p>The cooking zone is hot.</p> <p>The highest heat setting is set.</p>	<p>Let the cooking zone become sufficiently cool.</p> <p>The highest heat setting has the same power as the Automatic Heat Up function.</p>
The heat setting changes between two levels.	The Power management is activated.	Refer to "Power management".
Hob ² Hood function does not work	Object interrupting signal between hob and the hood, or object covering the control panel	Move items obstructing signal or covering control panel

TROUBLESHOOTING

The sensor fields become hot.	The cookware is too large or you put it too near to the controls.	Put large cookware on the rear cooking zones if necessary.
There is no signal when you touch the panel sensor fields.	The signals are deactivated.	Activate the signals (refer to "OffSound control").
 comes on	The automatic switch-off operates.	Deactivate the appliance and activate it again.
 comes on	The Child Safety Device or the Lock function operates.	Refer to the chapter "Operating instructions".
 comes on	<ul style="list-style-type: none"> • No cookware on the cooking zone. • Incorrect cookware. • The diameter of the bottom of the cookware is too small for the cooking zone. • The cookware do not cover the cross. 	<p>Put cookware on the cooking zone.</p> <p>Use the correct cookware.</p> <p>Use larger diameter cookware.</p> <p>Cover the cross fully.</p>
 and number comes on	There is an error in the appliance.	Disconnect the appliance from the electrical supply for some time. Disconnect the fuse from the electrical system of the house. Connect it again. If  comes on again, speak to the customer service centre.
 comes on	There is an error in the appliance, because either the cookware boils dry or you've used incorrect cookware. Overheating protection for cooking zone operates. The automatic switch-off operates.	Deactivate the appliance. Remove the hot cookware. After approximately 30 seconds, activate the cooking zone again. If the cookware was the problem, the error message goes out of the display, but the residual heat indicator can stay. Let the cookware become sufficiently cool and refer to "Cookware for the induction cooking zone" to see if your cookware is compatible with the appliance.

If you tried the above solutions and cannot repair the problem, speak to your dealer or the customer service centre. Give the data from the rating plate and an error message that comes on.

Make sure you operated the appliance correctly. If not the servicing by a customer service technician or dealer will not be free of charge, also during the warranty period. The instructions about the customer service and conditions of guarantee are in the guarantee booklet.

INSTALLATION



WARNING!

Refer to “Safety information” chapter.



IMPORTANT

BEFORE INSTALLATION

Before the installation of the appliance, record the information below from the rating plate. The rating plate is on the bottom of the appliance casing.

Model _____

PNC _____

Serial number _____

Built-in appliances

Only use the built-in appliances after you assemble the appliance into correct built-in units and work surfaces that align to the standards.

Connection cable

- Use the correct mains cable of type H05BB-F Tmax 90°C (or higher) 3 x 4mm² with an all-pole 32A breaker.
- The earth cord (green/yellow cable) must be 2cm longer than phase and neutral cable (blue and brown cables).

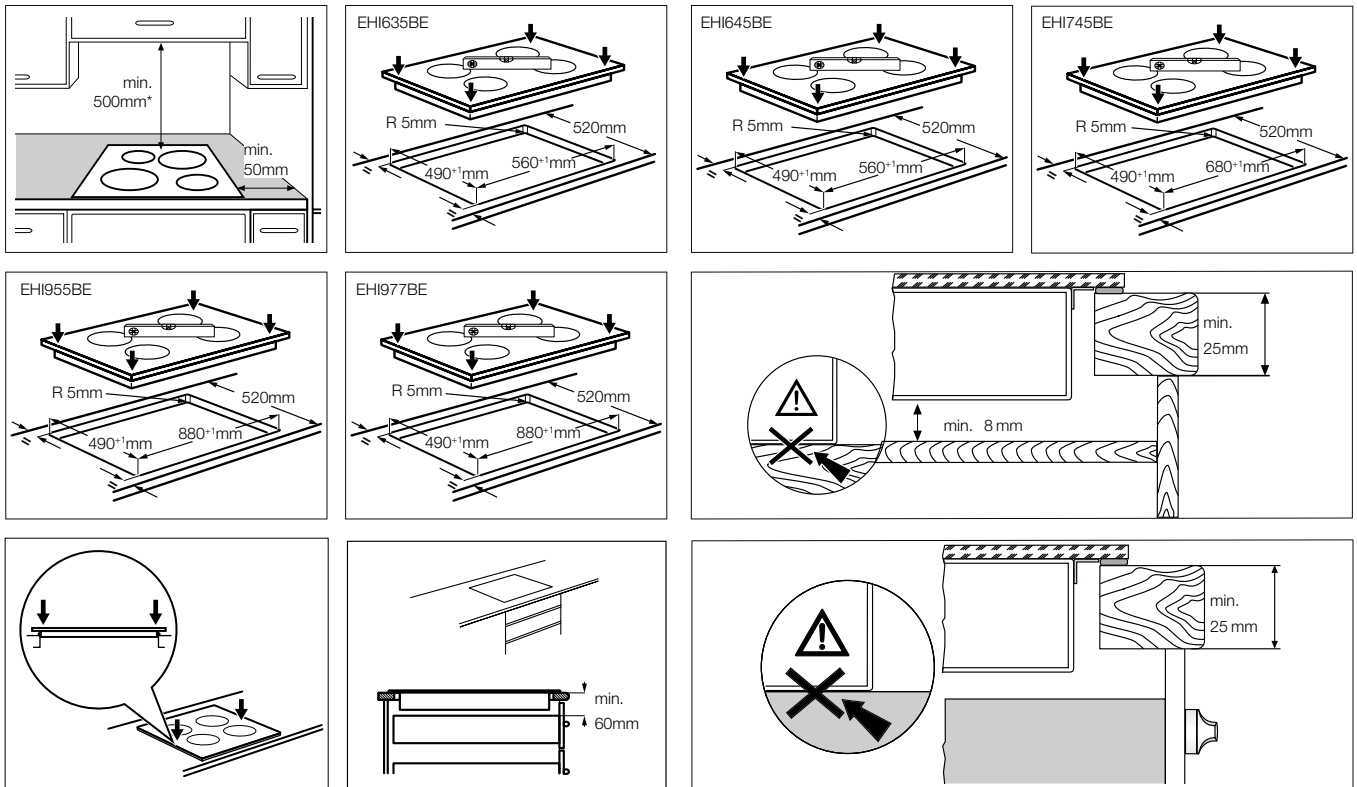

*Note: The clearance must meet or exceed the minimum recommended for both the rangehood and cooktop. Refer to the rangehood installation manual.

TECHNICAL INFORMATION

Model. _____

Ser.Nr. _____

ELECTROLUX

Voltage (volts)	220-240
Cycles (Hz)	50-60

EHI635BE Induction 7.4kW

Cooking zone	Nominal Power (Max heat setting) (W)	Power Function activated (W)	Power function maximum duration (min)	Minimum cookware diameter (mm)
Right front	1800 W	2800 W	5	145-245
	3500 W	5200 W	5	245-280
Left rear	2300 W	3200 W	10	125-210
Left front	2300 W	3200 W	10	125-210

EHI645BE Induction 7.4kW

Cooking zone	Nominal Power (Max heat setting) (W)	Power Function activated (W)	Power function maximum duration (min)	Minimum cookware diameter (mm)
Right front	1400 W	2500 W	4	125-145
Right rear	1800 W	2800 W	10	145-180
Left front	2300 W	3200 W	10	125-210
Left rear	2300 W	3200 W	10	125-210

EHI745BE Induction 7.4kW

Cooking zone	Nominal Power (Max heat setting) (W)	Power Function activated (W)	Power function maximum duration (min)	Minimum cookware diameter (mm)
Right front	1400 W	2500 W	4	125-145
Right rear	2300 W	3600 W	10	180-240
Left front	2300 W	3200 W	10	125-210
Left rear	2300 W	3200 W	10	125-210

EHI955BE Induction 7.4kW

Cooking zone	Nominal Power (Max heat setting) (W)	Power Function activated (W)	Power function maximum duration (min)	Minimum cookware diameter (mm)
Middle front	1800 W 3500 W	2800 W 5200 W	5 5	145-245 245-280
Right front	1400 W	2500 W	4	125-145
Right rear	1800 W	2800 W	10	145-180
Left front	2300 W	3200 W	10	125-210
Left rear	2300 W	3200 W	10	125-210

EHI977BE Induction 7.4kW

Cooking zone	Nominal Power (Max heat setting) (W)	Power Function activated (W)	Power function maximum duration (min)	Minimum cookware diameter (mm)
Middle front	1800 W 3500 W	2800 W 5200 W	5 5	145-245 245-280
Right front	1400 W	2500 W	4	125-145
Right rear	1800 W	2800 W	10	145-180
Flexible induction cooking area	2300 W	3400 W	10	Minimum 100

The power of the cooking zones can be different in some small ranges from the data in the table. It changes with the material and dimensions of the cookware.

**ENVIRONMENT**

Recycle the materials with the symbol .

Put the packaging in applicable containers to recycle it. Help protect the environment and human health by recycling electrical and electronic appliance waste correctly. Do not dispose appliances marked with the symbol  with the household waste. Return the product to your local recycling facility or contact your municipal office.

NOTES

NOTES

NOTES

FOR SALES IN AUSTRALIA AND NEW ZEALAND
 APPLIANCE: ELECTROLUX BUILT-IN OVENS, COOKTOPS,
 FREESTANDING COOKER AND WARMING DRAWER

This document sets out the terms and conditions of the product warranties for Electrolux Appliances. It is an important document. Please keep it with your proof of purchase documents in a safe place for future reference should there be a manufacturing defect in your Appliance. This warranty is in addition to other rights you may have under the Australian Consumer Law.

1. In this warranty:

- (a) 'ACL' or 'Australian Consumer Law' means Schedule 2 to the Competition and Consumer Act 2010;
- (b) 'Appliance' means any Electrolux product purchased by you and accompanied by this document;
- (c) 'ASC' means Electrolux's authorised serviced centres;
- (d) 'Electrolux' is the brand controlled by Electrolux Home Products Pty Ltd of 163 O'Riordan Street, Mascot NSW 2020, ABN 51 004 762 341 in respect of Appliances purchased in Australia and Electrolux (NZ) Limited (collectively "Electrolux") of 3-5 Niall Burgess Road, Mount Wellington, in respect of Appliances purchased in New Zealand;
- (e) 'Warranty Period' means the period specified in clause 3 of this warranty;
- (f) 'you' means the purchaser of the Appliance not having purchased the Appliance for re-sale, and 'your' has a corresponding meaning.

2. Application: This warranty only applies to new Appliances, purchased and used in Australia or New Zealand and is in addition to (and does not exclude, restrict, or modify in any way) other rights and remedies under a law to which the Appliances or services relate, including any non-excludable statutory guarantees in Australia and New Zealand.

3. Warranty Period: Subject to these terms and conditions, this warranty continues in Australia for a period of 24 months and in New Zealand for a period of 24 months, following the date of original purchase of the Appliance.

4. Repair or replace warranty: During the Warranty Period, Electrolux or its ASC will, at no extra charge if your Appliance is readily accessible for service, without special equipment and subject to these terms and conditions, repair or replace any parts which it considers to be defective. Electrolux may, in its absolute discretion, choose whether the remedy offered for a valid warranty claim is repair or replacement. Electrolux or its ASC may use refurbished parts to repair your Appliance. You agree that any replaced Appliances or parts become the property of Electrolux.

5. Travel and transportation costs: Subject to clause 7, Electrolux will bear the reasonable cost of transportation, travel and delivery of the Appliance to and from Electrolux or its ASC. Travel and transportation will be arranged by Electrolux as part of any valid warranty claim.

6. Proof of purchase is required before you can make a claim under this warranty.

7. Exclusions: You may not make a claim under this warranty unless the defect claimed is due to faulty or defective parts or workmanship. This warranty does not cover:

- (a) light globes, batteries, filters or similar perishable parts;
- (b) parts and Appliances not supplied by Electrolux;
- (c) cosmetic damage which does not affect the operation of the Appliance;

- (d) damage to the Appliance caused by:
 - (i) negligence or accident;
 - (ii) misuse or abuse, including failure to properly maintain or service;
 - (iii) improper, negligent or faulty servicing or repair works done by anyone other than an Electrolux authorised repairer or ASC;
 - (iv) normal wear and tear;
 - (v) power surges, electrical storm damage or incorrect power supply;
 - (vi) incomplete or improper installation;
 - (vii) incorrect, improper or inappropriate operation;
 - (viii) insect or vermin infestation;
 - (ix) failure to comply with any additional instructions supplied with the Appliance;

In addition, Electrolux is not liable under this warranty if:

- (a) the Appliance has been, or Electrolux reasonably believes that the Appliance has been, used for purposes other than those for which the Appliance was intended, including where the Appliance has been used for any non-domestic purpose;
- (b) the Appliance is modified without authority from Electrolux in writing;
- (c) the Appliance's serial number or warranty seal has been removed or defaced

8. How to claim under this warranty: To enquire about claiming under this warranty, please follow these steps:

- (a) carefully check the operating instructions, user manual and the terms of this warranty;
- (b) have the model and serial number of the Appliance available;
- (c) have the proof of purchase (e.g. an invoice) available;
- (d) telephone the numbers shown below.

9. Australia: For Appliances and services provided by Electrolux in Australia: Electrolux goods come with guarantees that cannot be excluded under the Australian Consumer Law. You are entitled to a replacement or refund for a major failure and for compensation for any other reasonably foreseeable loss or damage. You are also entitled to have the Appliance repaired or replaced if the Appliance fails to be of acceptable quality and the failure does not amount to a major failure. 'Acceptable quality' and 'major failure' have the same meaning as referred to in the ACL.

10. New Zealand: For Appliances and services provided by Electrolux in New Zealand, the Appliances come with a guarantee by Electrolux pursuant to the provisions of the Consumer Guarantees Act, the Sale of Goods Act and the Fair Trading Act. Where the Appliance was purchased in New Zealand for commercial purposes the Consumer Guarantee Act does not apply.

11. Confidentiality: You accept that if you make a warranty claim, Electrolux and its agents including ASC may exchange information in relation to you to enable Electrolux to meet its obligations under this warranty.

Important Notice

Before calling for service, please ensure that the steps listed in clause 8 above have been followed.

AUSTRALIA	FOR SERVICE or to find the address of your nearest authorised service centre in Australia PLEASE CALL 13 13 49 <small>For the cost of a local call</small>	FOR SPARE PARTS or to find the address of your nearest spare parts centre in Australia PLEASE CALL 13 13 50 <small>For the cost of a local call</small>
NEW ZEALAND	FOR SERVICE or to find the address of your nearest authorised service centre in New Zealand PLEASE CALL 0800 10 66 10	FOR SPARE PARTS or to find the address of your nearest spare parts centre in New Zealand PLEASE CALL 0800 10 66 20

Electrolux Home Products Australia

telephone: 1300 363 640
fax: 1800 350 067
email: customercare@electrolux.com.au
web: electrolux.com.au

shop.electrolux.com.au



Electrolux Home Products New Zealand

telephone: 0800 436 245
fax: 0800 225 088
email: customercare@electrolux.co.nz
web: electrolux.co.nz



To add a touch of professional inspiration to your home, visit electrolux.com.au or electrolux.co.nz

electrolux.com.au



or electrolux.co.nz



P/No. ANC A22211202 Rev.A

© 2021 Electrolux Home Products Pty Ltd.

EMAN_Induction_Hobs_Sep21