



## CONTENTS

1. SAFETY INFORMATION.....	3
2. SAFETY INSTRUCTIONS.....	4
3. PRODUCT DESCRIPTION.....	8
4. CONTROL PANEL.....	8
5. BEFORE FIRST USE.....	10
6. DAILY USE.....	11
7. CLOCK FUNCTIONS.....	18
8. AUTOMATIC PROGRAMMES.....	18
9. USING THE ACCESSORIES.....	19
10. ADDITIONAL FUNCTIONS.....	23
11. HINTS AND TIPS.....	25
12. CARE AND CLEANING.....	38
13. TROUBLESHOOTING.....	43
14. ENERGY EFFICIENCY.....	45

## WE'RE THINKING OF YOU

Thank you for purchasing an Electrolux appliance. You've chosen a product that brings with it decades of professional experience and innovation. Ingenious and stylish, it has been designed with you in mind. So whenever you use it, you can be safe in the knowledge that you'll get great results every time.

Welcome to Electrolux.

**Visit our website to:**



Get usage advice, brochures, trouble shooter, service and repair information:  
**[www.electrolux.com/support](http://www.electrolux.com/support)**



Register your product for better service:  
**[www.registerelectrolux.com](http://www.registerelectrolux.com)**



Buy Accessories, Consumables and Original spare parts for your appliance:  
**[www.electrolux.com/shop](http://www.electrolux.com/shop)**

## CUSTOMER CARE AND SERVICE

Always use original spare parts.

When contacting our Authorised Service Centre, ensure that you have the following data available: Model, PNC, Serial Number.

The information can be found on the rating plate.

 Warning / Caution-Safety information

 General information and tips

 Environmental information

Subject to change without notice.

## 1. ⚠ SAFETY INFORMATION

Before the installation and use of the appliance, carefully read the supplied instructions. The manufacturer is not responsible for any injuries or damage that are the result of incorrect installation or usage. Always keep the instructions in a safe and accessible location for future reference.

### 1.1 Children and vulnerable people safety

- This appliance can be used by children aged from 8 years and above and persons with reduced physical, sensory or mental capabilities or lack of experience and knowledge if they have been given supervision or instruction concerning the use of the appliance in a safe way and understand the hazards involved. Children of less than 8 years of age and persons with very extensive and complex disabilities shall be kept away from the appliance unless continuously supervised.
- Children should be supervised to ensure that they do not play with the appliance.
- Keep all packaging away from children and dispose of it appropriately.
- **WARNING:** Keep children and pets away from the appliance when it operates or when it cools down. Accessible parts become hot during use.
- If the appliance has a child safety device, it should be activated.
- Children shall not carry out cleaning and user maintenance of the appliance without supervision.

### 1.2 General Safety

- Only a qualified person must install this appliance and replace the cable.
- Do not use the appliance before installing it in the built-in structure.

- Disconnect the appliance from the power supply before carrying out any maintenance.
- If the mains power supply cable is damaged, it must be replaced by the manufacturer, its Authorised Service Centre or similarly qualified persons to avoid an electrical hazard.
- **WARNING:** Ensure that the appliance is switched off before replacing the lamp to avoid the possibility of electric shock.
- **WARNING:** The appliance and its accessible parts become hot during use. Care should be taken to avoid touching heating elements.
- Always use oven gloves to remove or put in accessories or ovenware.
- Use only the food sensor (core temperature sensor) recommended for this appliance.
- To remove the shelf supports first pull the front of the shelf support and then the rear end away from the side walls. Install the shelf supports in the opposite sequence.
- Do not use a steam cleaner to clean the appliance.
- Do not use harsh abrasive cleaners or sharp metal scrapers to clean the glass door since they can scratch the surface, which may result in shattering of the glass.
- Excessive spillage must be removed before the pyrolytic cleaning. Remove all parts from the oven.

## 2. SAFETY INSTRUCTIONS

### 2.1 Installation



**WARNING!**

Only a qualified person must install this appliance.

- Remove all the packaging.
- Do not install or use a damaged appliance.
- Follow the installation instructions supplied with the appliance.
- Always take care when moving the appliance as it is heavy. Always use safety gloves and enclosed footwear.
- Do not pull the appliance by the handle.
- Install the appliance in a safe and suitable place that meets installation requirements.
- Keep the minimum distance from other appliances and units.
- Before mounting the appliance, check if the oven door opens without restraint.

- The appliance is equipped with an electric cooling system. It must be operated with the electric power supply.

Cabinet minimum height (Cabinet under the worktop minimum height)	590 (600) mm
Cabinet width	560 mm
Cabinet depth	550 (550) mm
Height of the front of the appliance	594 mm
Height of the back of the appliance	576 mm
Width of the front of the appliance	595 mm
Width of the back of the appliance	559 mm
Depth of the appliance	569 mm
Built in depth of the appliance	548 mm
Depth with open door	1022 mm
Ventilation opening minimum size. Opening placed on the bottom rear side	560x20 mm
Mains supply cable length. Cable is placed in the right corner of the back side	1500 mm
Mounting screws	4x25 mm

## 2.2 Electrical connection



### **WARNING!**

Risk of fire and electric shock.

- All electrical connections should be made by a qualified electrician.
- The appliance must be earthed.
- Make sure that the parameters on the rating plate are compatible with the

electrical ratings of the mains power supply.

- Always use a correctly installed shockproof socket.
- Do not use multi-plug adapters and extension cables.
- Make sure not to cause damage to the mains plug and to the mains cable. Should the mains cable need to be replaced, this must be carried out by our Authorised Service Centre.
- Do not let mains cables touch or come near the appliance door or the niche below the appliance, especially when it operates or the door is hot.
- The shock protection of live and insulated parts must be fastened in such a way that it cannot be removed without tools.
- Connect the mains plug to the mains socket only at the end of the installation. Make sure that there is access to the mains plug after the installation.
- If the mains socket is loose, do not connect the mains plug.
- Do not pull the mains cable to disconnect the appliance. Always pull the mains plug.
- Use only correct isolation devices: line protecting cut-outs, fuses (screw type fuses removed from the holder), earth leakage trips and contactors.
- The electrical installation must have an isolation device which lets you disconnect the appliance from the mains at all poles. The isolation device must have a contact opening width of minimum 3 mm.
- Fully close the appliance door before you connect the mains plug to the mains socket.
- This appliance is supplied only with a main cable.

### **Cable types applicable for installation or replacement for Europe:**

H07 RN-F, H05 RN-F, H05 RRF, H05 VV-F, H05 V2V2-F (T90), H05 BB-F

For the section of the cable refer to the total power on the rating plate. You can also refer to the table:

Total power (W)	Section of the cable (mm <sup>2</sup> )
maximum 1380	3 x 0.75
maximum 2300	3 x 1
maximum 3680	3 x 1.5

The earth cord (green / yellow cable) must be 2 cm longer than phase and neutral cables (blue and brown cables).

### 2.3 Use



**WARNING!**  
Risk of injury, burns and electric shock or explosion.

- This appliance is for household (indoors) use only.
- Do not change the specification of this appliance.
- Make sure that the ventilation openings are not blocked.
- Do not let the appliance stay unattended during operation.
- Deactivate the appliance after each use.
- Be careful when you open the appliance door while the appliance is in operation. Hot air can release.
- Do not operate the appliance with wet hands or when it has contact with water.
- Do not apply pressure on the open door.
- Do not use the appliance as a work surface or as a storage surface.
- Open the appliance door carefully. The use of ingredients with alcohol can cause a mixture of alcohol and air.
- Do not let sparks or open flames to come in contact with the appliance when you open the door.
- Do not put flammable products or items that are wet with flammable products in, near or on the appliance.



**WARNING!**  
Risk of damage to the appliance.

- To prevent damage or discoloration to the enamel:

- do not put overware or other objects in the appliance directly on the bottom.
- do not put aluminium foil directly on the bottom of cavity of the appliance.
- do not put water directly into the hot appliance.
- do not keep moist dishes and food in the appliance after you finish the cooking.
- be careful when you remove or install the accessories.
- Discoloration of the enamel or stainless steel has no effect on the performance of the appliance.
- Use a deep pan for moist cakes. Fruit juices cause stains that can be permanent.
- This appliance is for cooking purposes only. It must not be used for other purposes, for example room heating.
- Always cook with the oven door closed.
- If the appliance is installed behind a furniture panel (e.g. a door) make sure the door is never closed when the appliance operates. Heat and moisture can build up behind a closed furniture panel and cause subsequent damage to the appliance, the housing unit or the floor. Do not close the furniture panel until the appliance has cooled down completely after use.

### 2.4 Care and cleaning



**WARNING!**  
Risk of injury, fire, or damage to the appliance.

- Before maintenance, deactivate the appliance and disconnect the mains plug from the mains socket.
- Make sure the appliance is cold. There is the risk that the glass panels can break.
- Replace immediately the door glass panels when they are damaged. Contact the Authorised Service Centre.
- Be careful when you remove the door from the appliance. The door is heavy!

- Clean regularly the appliance to prevent the deterioration of the surface material.
- Clean the appliance with a moist soft cloth. Use only neutral detergents. Do not use abrasive products, abrasive cleaning pads, solvents or metal objects.
- If you use an oven spray, follow the safety instructions on its packaging.

## 2.5 Pyrolytic cleaning



### **WARNING!**

Risk of Injury / Fires / Chemical Emissions (Fumes) in Pyrolytic Mode.

- Before carrying out a Pyrolytic self-cleaning function or the First Use please remove from the oven cavity:
  - any excess food residues, oil or grease spills / deposits.
  - any removable objects (including shelves, side rails etc., provided with the product) particularly any non-stick pots, pans, trays, utensils etc.
- Read carefully all the instructions for Pyrolytic cleaning.
- Keep children away from the appliance while the Pyrolytic cleaning operates.  
The appliance becomes very hot and hot air is released from the front cooling vents.
- Pyrolytic cleaning is a high temperature operation that can release fumes from cooking residues and construction materials, as such consumers are strongly advised to:
  - provide good ventilation during and after each Pyrolytic cleaning.
  - provide good ventilation during and after the first use at maximum temperature operation.
- Unlike all humans, some birds and reptiles can be extremely sensitive to potential fumes emitted during the cleaning process of all Pyrolytic Ovens.
  - Remove any pets (especially birds) from the vicinity of the appliance location during and after the Pyrolytic cleaning and first use maximum temperature

operation to a well ventilated area.

- Small pets can also be highly sensitive to the localized temperature changes in the vicinity of all Pyrolytic Ovens when the Pyrolytic self cleaning program is in operation.
- Non-stick surfaces on pots, pans, trays, utensils etc., can be damaged by the high temperature Pyrolytic cleaning operation of all Pyrolytic Ovens and can be also a source for low level harmful fumes.
- Fumes released from all Pyrolytic Ovens / Cooking Residues as described are not harmful to humans, including children, or persons with medical conditions.

## 2.6 Steam Cooking



### **WARNING!**

Risk of burns and damage to the appliance.

- Released Steam can cause burns:
  - Do not open the appliance door during the steam cooking operation.
  - Open the appliance door with care after the steam cooking operation.

## 2.7 Internal lighting



### **WARNING!**

Risk of electric shock.

- Concerning the lamp(s) inside this product and spare part lamps sold separately: These lamps are intended to withstand extreme physical conditions in household appliances, such as temperature, vibration, humidity, or are intended to signal information about the operational status of the appliance. They are not intended to be used in other applications and are not suitable for household room illumination.
- Use only lamps with the same specifications.

## 2.8 Service

- To repair the appliance contact the Authorised Service Centre.

- Use original spare parts only.

## 2.9 Disposal



### WARNING!

Risk of injury or suffocation.

- Contact your municipal authority for information on how to dispose of the appliance.

- Disconnect the appliance from the mains supply.
- Cut off the mains electrical cable close to the appliance and dispose of it.
- Remove the door catch to prevent children or pets from becoming trapped in the appliance.

## 3. PRODUCT DESCRIPTION

### 3.1 General overview

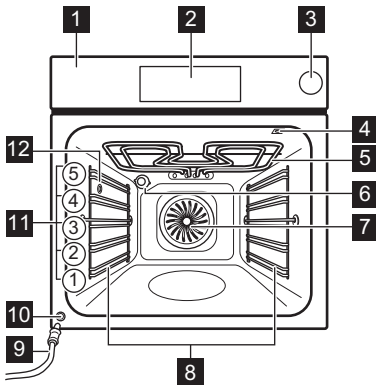

- 1** Control panel
- 2** Electronic programmer
- 3** Water drawer
- 4** Socket for the food sensor
- 5** Heating element
- 6** Lamp
- 7** Fan
- 8** Shelf support, removable
- 9** Draining pipe
- 10** Water outlet valve
- 11** Shelf positions
- 12** Steam inlet

### 3.2 Accessories

- **Wire shelf**  
For cookware, cake tins, roasts.
- **Baking tray**  
For cakes and biscuits.
- **Grill- / Roasting pan**

- **Food sensor**  
To measure how far the food is cooked.
- **Water drawer**  
To bake and roast or as pan to collect fat.





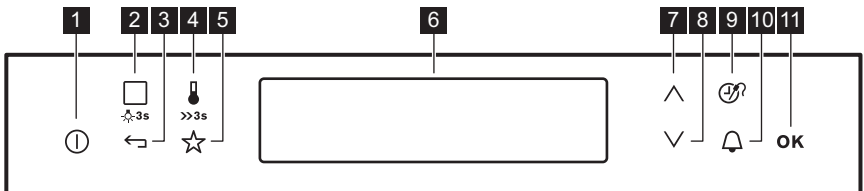



## 4. CONTROL PANEL

### 4.1 Electronic programmer





## Use the sensor fields to operate the oven.





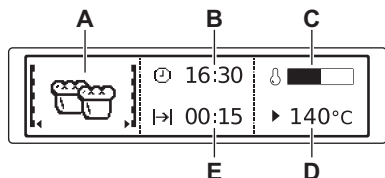







Sensor field	Function	Comment
1 	ON / OFF	To turn on and off the oven.
2 	Heating Functions or Assisted Cooking	Press the sensor field once to choose a heating function or the menu: Assisted Cooking. Press the sensor field again to switch between the menus: Heating Functions, Assisted Cooking. To turn on or off the light, press the field for 3 seconds.
3 	Back	To go back one level in the menu. To show the main menu, touch the field for 3 seconds.
4 	Temperature selection/ Fast Heat Up	To set the temperature or show the current temperature in the oven. Press the field for 3 seconds to turn on or off the function: Fast Heat Up.
5 	Favourites	To save and access your favourite programmes.
6 -	Display	Shows the current settings of the oven.
7 	Up	To move up in the menu.
8 	Down	To move down in the menu.
9 	Time and additional functions	To set different functions. When a heating function operates, press the sensor field to set the timer or the functions: Function Lock, Favourites, Heat + Hold, Set + Go. You can also change the settings of the food sensor.
10 	Minute Minder	To set the function: Minute Minder.
11 OK	OK	To confirm the selection or setting.

## 4.2 Display

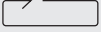

- A. Heating function
- B. Time of day
- C. Heat-up indicator
- D. Temperature
- E. Duration time or end time of a function

**Other indicators of the display:**

Symbol		Function
	Minute Minder	The function works.
	Time of day	The display shows the current time.
	Duration	The display shows the necessary time for cooking.
	End Time	The display shows when the cooking time is complete.
	Temperature	The display shows the temperature.
	Time Indication	The display shows how long the heating function works. Press  and  at the same time to reset the time.
	Calculation	The oven calculates the time for cooking.
	Heat-up Indicator	The display shows the temperature in the oven.
	Fast Heat Up	The function is on. It decreases the heat up time.
	Weight Automatic	The display shows that the automatic weight system is on or that weight can be changed.
	Heat + Hold	The function is on.

## 5. BEFORE FIRST USE

**WARNING!**

Refer to Safety chapters.



### 5.1 Initial Cleaning

Step 1	Step 2	Step 3
Remove all accessories and removable shelf supports from the oven.	Clean the oven and the accessories with a soft cloth, warm water and a mild detergent.	Place the accessories and the removable shelf supports in the oven.

### 5.2 First Connection

Before the first use you have to set:			
Language	Display contrast	Display Brightness	Time of day

## 5.3 Initial preheating



<b>Preheat the empty oven before the first use.</b>	
<b>Step 1</b>	Remove all accessories and removable shelf supports from the oven.
<b>Step 2</b>	Set the maximum temperature for the function:  Let the oven operate for 1 h.
<b>Step 3</b>	Set the maximum temperature for the function:  Let the oven operate for 15 min.
 The oven can emit an odour and smoke during preheating. Make sure that the room is ventilated.	

## 6. DAILY USE



**WARNING!**  
Refer to Safety chapters.



### 6.1 Navigating the menus

1. Turn on the oven.
2. Press  or  to select the menu option.
3. Press  to move to the submenu or accept the setting.



At each point you can go back to the main menu with .

### 6.2 Setting a heating function



1. Turn on the oven.
2. Select the menu: Heating Functions.
3. Press  to confirm.
4. Select a heating function.
5. Press  to confirm.
6. Set the temperature.
7. Press  to confirm.

### 6.3 Setting a steam function

The water drawer cover is in the control panel.



**WARNING!**  
Use only cold tap water. Do not use filtered (demineralised) or distilled water. Do not use other liquids. Do not put flammable or alcoholic liquids into the water drawer.

1. Press the cover of the water drawer to open it.
2. Fill the water drawer with 900 ml of water.  
The water supply is sufficient for approximately 55 - 60 minutes.
3. Push the water drawer to its initial position.
4. Turn on the oven.
5. Set a steam heating function and the temperature.
6. If necessary, set the function:  
Duration  or: End Time .



When the steam generator is empty, the signal sounds.

The signal sounds at the end of the cooking time.

7. Turn off the oven.
8. Empty the water tank after the steam cooking is completed. Refer to the cleaning function: Tank Emptying.

**CAUTION!**

The oven is hot. There is a risk of burns. Be careful when you empty the water tank.

- After steam cooking steam can condensate on the bottom of the cavity. Always dry the bottom of the cavity when the oven is cool. Let the oven dry fully with the door open.

**WARNING!**

Wait a minimum of 60 minutes after each use of the steam cooking in order to prevent hot water from exiting the water outlet valve.

## 6.4 Tank Empty indicator

The display shows: Water required and a signal sounds when the tank is empty and must be refilled.

For more information refer to "Daily use" chapter, Setting a steam function.

## 6.5 Tank Full indicator

When the display shows: Water tank full, you can use the steam cooking.

A signal sounds when the tank is full.



If you put too much water into the tank, the safety outlet moves the excess water to the bottom of the oven.

Remove the water with a sponge or cloth.

## 6.6 Emptying the water tank

**CAUTION!**

Make sure that the oven is cold before you start to empty the water tank.

Empty the water tank after each steam cooking.

- Prepare the draining pipe (C), included in the same package with the user manual. Put the connector (B) onto one of the ends of the draining pipe.

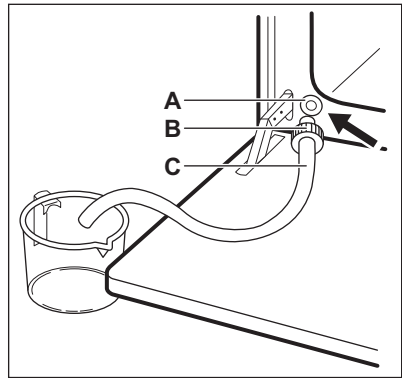

- Put the second end of the draining pipe (C) into a container. Put it at a lower position than the outlet valve (A).
- Open the oven door and put the connector (B) into the outlet valve (A).
- Push the connector again and again when you empty the water tank.



The tank can have some water when the display shows: Water required. Wait until the water flow from the water outlet valve stops.

- Remove the connector from the valve when the water stops flowing.



Do not use the drained water to fill the water tank again.

## 6.7 Heat-up indicator

When you turn on a heating function, the bar shows that the temperature increases. When temperature is reached the signal sounds 3 times, the bar flashes and disappears.

## 6.8 Using: Fast Heat Up

Use this function before you put the food in the oven.

This function reduces the heat-up time. It is not available for some oven functions.









>>> - press and hold.

## 6.9 Residual heat













When you turn off the oven, the display shows the residual heat. You can use the heat to keep the food warm.





## 6.10 The menus in overview

### Main menu





Symbol / Menu item	Application
 Heating Functions	Contains a list of heating functions.
 Recipes	Contains a list of automatic programmes.
 Favourites	Contains a list of favourite cooking programmes created by the user.
 Cleaning	Contains a list of cleaning programmes.
 Basic Settings	Used to set the appliance configuration.
 Specials	Contains a list of additional heating functions.
 Assisted Cooking	Contains recommended oven settings for a wide choice of dishes. Select a dish and start the cooking process. The temperature and time are only guidelines for a better result and can be adjusted. They depend on the recipes and the quality and quantity of the used ingredients.





### Submenu for: Basic Settings

Symbol / Menu item	Description
 Set Time of Day	Sets the current time on the clock.
 Time Indication	When ON, the display shows the current time when you deactivate the appliance.
 Fast Heat Up	When ON, the function decreases the heat-up time.
 Set + Go	To set a function and activate it later with a press of any symbol on the control panel.
 Heat + Hold	Keeps the prepared food warm for 30 minutes after a cooking cycle finished.
 Time Extension	Activates and deactivates the time extension function.
 Display Contrast	Adjusts the display contrast by degrees.
 Display Brightness	Adjusts the display brightness by degrees.
 Set Language	Sets the language for the display.
 Buzzer Volume	Adjusts the volume of press-tones and signals by degrees.
 Key Tones	Activates and deactivates the tone of the touch fields. It is not possible to deactivate the tone of the ON / OFF touch field.
 Alarm / Error Tones	Activates and deactivates the alarm tones.









Symbol / Menu item	Description
 Cleaning Reminder	Reminds you when to clean the appliance.
 DEMO mode	Activation / deactivation code: 2468.
 Service	Shows the software version and configuration.
 Factory Settings	Resets all settings to factory settings.

## 6.11 Heating Functions

Heating function	Application
 True Fan Cooking	To bake on up to three shelf positions at the same time and to dry food. Set the temperature 20 - 40 °C lower than for the function: Conventional Cooking.
 Humidity Low	To bake bread, roast large pieces of meat or to warm up chilled and frozen meals.
 Pizza Function	To bake food on one shelf position for a more intensive browning and a crispy bottom. Set the temperature 20 - 40 °C lower than for the function: Conventional Cooking.
 Conventional Cooking	To bake and roast food on one shelf position.
 Frozen Foods	To make convenience food (e.g., french fries, potato wedges or spring rolls) crispy.

Heating function	Application
 Grill	To grill thin pieces of food and to toast bread.
 Turbo Grilling	To roast large meat joints or poultry with bones on one shelf position. To make gratins and to brown.
 Bottom Heat	To bake cakes with crispy bottom and to preserve food.
 Moist Fan Baking	This function is designed to save energy during cooking. When you use this function, the temperature in the cavity may differ from the set temperature. The residual heat is used. The heating power may be reduced. For more information refer to "Daily Use" chapter, Notes on: Moist Fan Baking.
 Steam Regenerating	Food reheating with steam prevents surface drying. Heat is distributed in a gentle and even way, which allows to recover taste and aroma of food as just prepared. This function can be used to reheat food directly on a plate. You can reheat more than one plate at the same time, using different shelf positions.

## 6.12 Specials

Heating function	Application
 Keep Warm	To keep food warm.
 Plate Warming	To preheat plates for serving.
 Preserving	To preserve vegetables (e.g., pickles).
 Dehydrating	To dry sliced fruit, vegetables and mushrooms.
 Dough Proving	To speed up the rising of the yeast dough. It prevents dough surface from drying and keeps the dough elastic.
 Slow Cooking	To prepare tender, succulent roasts.
 Bread Baking	Use this function to prepare bread and bread rolls with professional-like result in terms of crispiness, colour and crust gloss.
 Defrost	To defrost food (vegetables and fruit). The defrosting time depends on the amount and size of the frozen food.
 Au Gratin	For dishes such as lasagna or potato gratin. To make gratins and to brown.

## 6.13 Notes on: Moist Fan Baking

This function was used to comply with the energy efficiency class and ecodesign requirements according to EU 65/2014 and EU 66/2014. Tests according to EN 60350-1.

The oven door should be closed during cooking so that the function is not interrupted and the oven operates with the highest energy efficiency possible.

When you use this function the lamp automatically turns off after 30 sec.

For the cooking instructions refer to "Hints and tips" chapter, Moist Fan Baking. For general energy saving recommendations refer to "Energy Efficiency" chapter, Energy Saving.

## 6.14 Assisted Cooking

### Food Category: Fish / Seafood







Dish	
Fish	Fish, baked
	Fish fingers
	Fish fillet, frozen
	Whole small fish, grilled
	Whole fish, grilled
	Whole fish, grilled 
Whole salmon	-



### Food Category: Poultry

Dish	
Boned poultry	-

Dish	
Chicken	Chicken wings, fresh
	Chicken wings, frozen
	Chicken legs, fresh
	Chicken legs, frozen
	Chicken, 2 halves

**Food Category: Meat**

Dish	
Beef	Braised meat 
	Meatloaf
Roast beef	Rare
	Rare 
	Medium
	Medium 
	Well done
	Well done 
Scandinavian beef	Rare 
	Medium 
	Well done 
Pork	Spare ribs
	Pork knuckle, pre-cooked
	Pork joint
	Loin of pork
	Pork neck
	Pork shoulder
Veal	Veal knuckle
	Loin of veal

Dish	
Lamb	Leg of lamb
	Saddle of lamb
	Lamb joint, medium
Game	Hare <ul style="list-style-type: none"> <li>• Leg of hare</li> <li>• Saddle of hare</li> <li>• Saddle of hare </li> </ul>
	Venison <ul style="list-style-type: none"> <li>• Haunch of venison</li> <li>• Saddle of venison</li> </ul>
	Roast game 
	Loin of game 

**Food Category: Oven Dishes**

Dish	
Lasagne / Canneloni, frozen	-
Vegetables au gratin	-
Sweet dishes	-

**Food Category: Pizza / Quiche**

Dish	
Pizza	Pizza, thin
	Pizza, extra topping
	Pizza, frozen
	Pizza American, frozen
	Pizza, chilled
	Pizza snacks, frozen
Baguettes au gratin	-



Dish	
Tarte flambée	-
Swiss Tarte, savoury	-
Quiche lorraine	-
Savory flan	-

### Food Category: Cake / Pastry

Dish	
Ring cake	-
Apple cake, covered	-
Sponge cake	-
Apple pie	-
Cheese cake, tin	-
Brioche	-
Madeira cake	-
Tarte	-
Swiss Tarte, sweet	-
Almond cake	-
Muffins	-
Pastry	-
Pastry strips	-
Cream puffs	-
Puff pastry	-
Eclairs	-
Macaroons	-
Short pastry biscuits	-
Christmas stollen	-
Apple strudel, frozen	-
Cake on tray	Sponge dough Yeast dough
Cheese cake, tray	-

Dish	
Brownies	-
Swiss roll	-
Yeast cake	-
Crumble cake	-
Sugar cake	-
Flan base	Short pastry flan base Sponge mixture flan base
Fruit flan	Short pastry fruit flan Sponge mixture fruit flan Yeast dough

### Food Category: Bread / Rolls

Dish	
Rolls	Rolls, frozen
Ciabatta	-
Bread	Bread crown Yeast plait Unleavened bread

### Food Category: Side dishes



Dish	
French fries, thin	-
French fries, thick	-
French fries, frozen	-
Croquettes	-
Wedges	-
Hash browns	-



When it is necessary to change the weight or the core temperature of the dish, use  $\wedge$  or  $\vee$  to set the new values.

## 7. CLOCK FUNCTIONS

### 7.1 Clock functions table



Clock function	Application
 Minute Minder	To set a countdown (max. 2 h 30 min). This function has no effect on the operation of the oven.
 Duration	To set how long the oven works (max. 23 h 59 min). It is not available for: Food Sensor.
 End Time	To set the switch-off time for a heating function (max. 23 h 59 min). It is not available for: Food Sensor.

If you set the time for a clock function, the time starts to count down after 5 sec.

Duration, End Time - before you use the functions you must set a heating function and temperature. The oven turns off automatically.

Duration, End Time - you can use the functions at the same time if you want to automatically turn on and turn off the oven on a given time later.

### 7.2 Setting the clock functions

1. Set a heating function.
2.  - press again and again until the display shows the necessary clock function and the related symbol.
3.  ,  - press to set the time.
4. Press: OK.

When the time ends, a signal sounds. The oven turns off. The display shows a message.

5. Press any symbol to stop the signal.

### 7.3 Heat + Hold

Conditions for the function:

- The set temperature is more than 80 °C.
- The function: Duration is set.

The function: Heat + Hold keeps prepared food warm at 80 °C for 30 minutes. It turns on after the baking or roasting procedure ends.

You can turn on or turn off the function in the menu: Basic Settings.



1. Turn on the oven.
  2. Select the heating function.
  3. Set the temperature above 80 °C.
  4. Press  again and again until the display shows: Heat + Hold.
  5. Press OK to confirm.
- When the function ends, a signal sounds.

### 7.4 Time Extension

The function: Time Extension makes the heating function continue after the end of Duration.



Applicable to all heating functions with Duration or Weight Automatic.  
Not applicable to heating functions with the food sensor.

1. When the cooking time ends, a signal sounds. Press any symbol. The display shows the message.
2. Press  to turn on or  to cancel.
3. Set the length of the function.
4. Press OK.

## 8. AUTOMATIC PROGRAMMES



### WARNING!

Refer to Safety chapters.

## 8.1 Recipes with Recipe Automatic

This oven has a set of recipes you can use. The recipes are fixed and you cannot change them.

1. Turn on the oven.
2. Select the menu: Recipes. Press **OK** to confirm.
3. Select the category and dish. Press **OK** to confirm.
4. Select a recipe. Press **OK** to confirm.

## 8.2 Assisted Cooking with Weight Automatic

This function automatically calculates the cooking time. To use it, it is necessary to input the food weight.

1. Turn on the oven.
2. Select the menu: Assisted Cooking. Press **OK**.
3. Select the dish with the function: Weight Automatic. Press **OK**.
4. Press **^** or **v** to set the food weight. Press **OK**.

The automatic programme starts.

5. You can change the weight at any time. Press **^** or **v** to change the weight.
6. When the time ends, a signal sounds. Press any symbol to turn off the signal.

# 9. USING THE ACCESSORIES



**WARNING!**  
Refer to Safety chapters.

## 9.1 Food Sensor

Food Sensor - measures the temperature inside the food. When the food is at the set temperature, the oven turns off.

The oven calculates an approximate end of cooking time. It depends on the quantity of food, the heating function and the temperature.

Set 2 temperatures:

- the oven temperature: minimum 120 °C,
- the food core temperature.

For the best cooking results:

- Ingredients should be at the room temperature.
- Food Sensor - do not use it with liquid dishes.
- Food Sensor - during cooking it must remain in the dish.

Food categories: meat, poultry and fish

1. Activate the appliance.

2. Insert the tip of the core temperature sensor into the centre of meat or fish, in the thickest part if possible. Make sure that at least 3/4 of the core temperature sensor is inside of the dish.
3. Put the plug of the core temperature sensor into the socket on the side wall of the appliance.

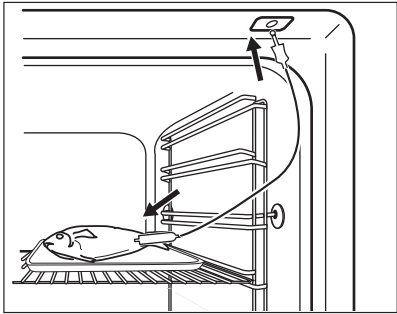
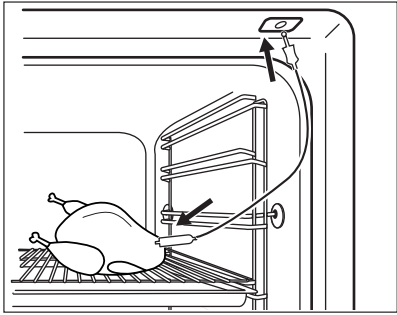

The display shows the core temperature sensor symbol.

4. Press  $\wedge$  or  $\vee$  in less than 5 seconds to set the food core temperature.
5. Set a heating function and, if necessary, the oven temperature.
6. To change the food core temperature, press  $\text{Ⓢ}$ .

When the dish reaches the set temperature, an acoustic signal sounds. The appliance deactivates automatically.

7. Touch any symbol to stop the signal.
8. Remove the core temperature sensor plug from the socket and remove the dish from the appliance.



**WARNING!**

There is a risk of burns as the core temperature sensor becomes hot. Be careful when you unplug it and remove it from the food.

**Food category: casserole**

1. Activate the appliance.
2. Place half of the ingredients in a baking dish.

3. Insert the tip of the core temperature sensor exactly in the centre of the casserole. The core temperature sensor should be stabilized in one place during baking. Use a solid ingredient to achieve that. Use the rim of the baking dish to support the silicone handle of the core temperature sensor. The tip of the core temperature sensor should not touch the bottom of a baking dish.

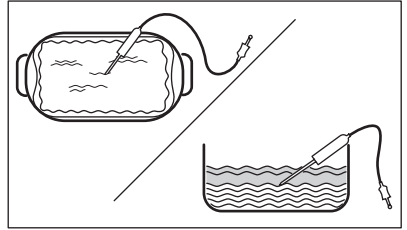

4. Cover the core temperature sensor with the remaining ingredients.
5. Put the plug of the core temperature sensor into the socket on the side wall of the appliance.

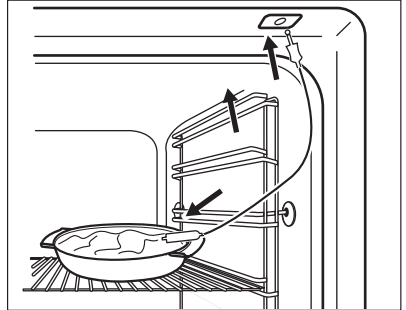

The display shows the core temperature sensor symbol.

6. Press  $\wedge$  or  $\vee$  in less than 5 seconds to set the food core temperature.
7. Set a heating function and, if necessary, the oven temperature.
8. To change the food core temperature, press  $\text{Ⓢ}$ .

When the dish is at the set temperature, an acoustic signal sounds. The appliance deactivates automatically.

9. Touch any symbol to stop the signal.
10. Remove the core temperature sensor plug from the socket and remove the dish from the appliance.

**WARNING!**

There is a risk of burns as the core temperature sensor becomes hot. Be careful when you unplug it and remove it from the food.

**9.2 Inserting accessories**

A small indentation at the top increases safety. The indentations are also anti-tip devices. The high rim around the shelf prevents cookware from slipping of the shelf.

**Wireshelf:**

Push the shelf between the guide bars of the shelf support and make sure that the feet point down.

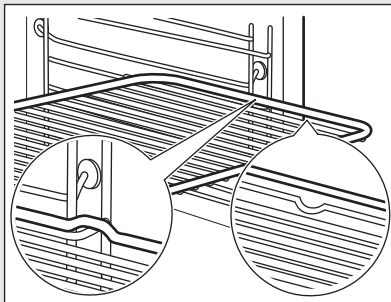
**Baking tray / Deep pan:**

Push the tray between the guide bars of the shelf support.

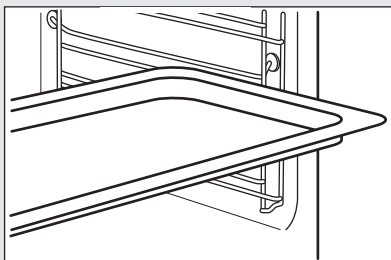
**Wireshelf, Baking tray / Deep pan:**

Push the tray between the guide bars of the shelf support and the wire shelf on the guide bars above.

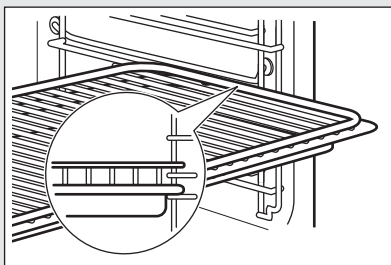
**9.3 Accessories for steam cooking**

The steam kit accessories are not supplied with the oven. For more information, please contact your local supplier.

**The dietary baking dish for steam cooking functions**

Dietary Baking dish consists of a glass bowl (A), a lid (B), injector tube (C), injector (D), and a steel grill (E).

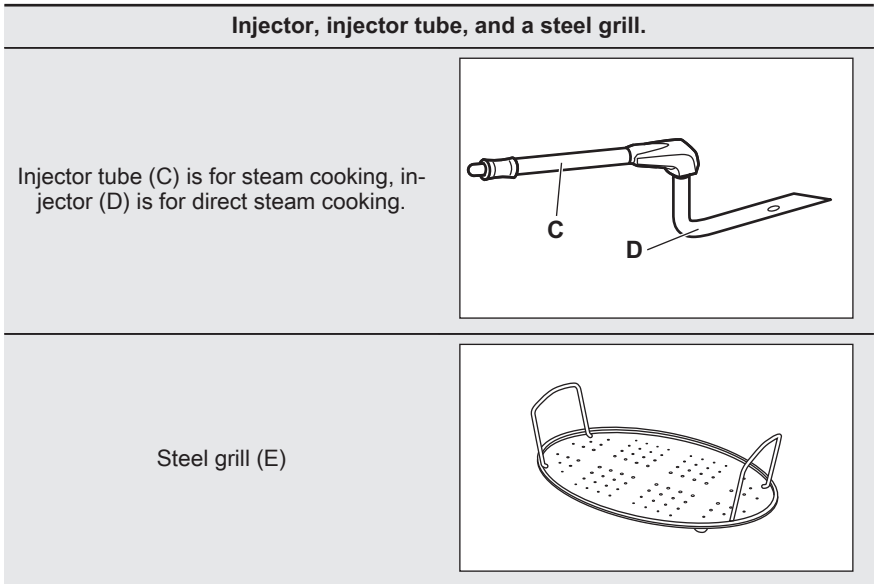
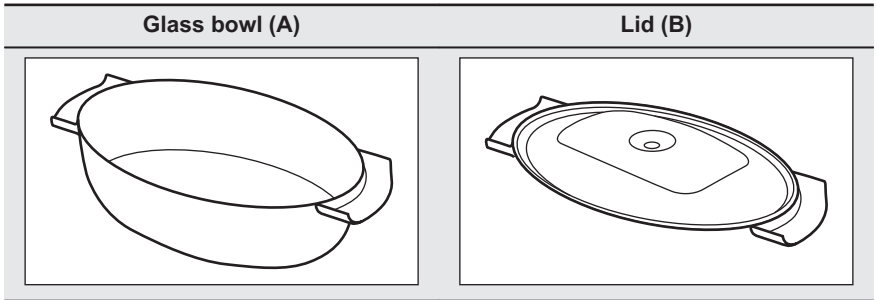

- Do not put the hot baking dish on cold / wet surfaces.
- Do not pour cold liquids into the baking dish when it is hot.
- Do not use the baking dish on a hot cooking surface.

- Do not clean the baking dish with abrasives, scourers and powders.

### 9.4 Steam cooking in a dietary baking dish

<b>Step 1</b>	Put the baking dish on the steel grill and cover it with the lid. Put the injector tube into the hole in the lid. Put the baking dish onto the second shelf position from the bottom.
<b>Step 2</b>	Connect the injector tube to the steam inlet.
<b>Step 3</b>	Set the oven for the steam cooking function.

## 9.5 Direct steam cooking

**Put the baking dish on the steel grill. Add some water. Do not use the lid.**



**WARNING!**

The injector may be hot when oven operates. Always use oven gloves. Remove the injector from the oven when you do not use steam function.

- |               |  |
|---------------|--|
| <b>Step 1</b> | Connect injector with injector tube. Connect injector tube to the steam inlet.   |
| <b>Step 2</b> | Put the baking dish onto the first or second shelf position from the bottom.<br>Make sure that injector tube is not jammed. Keep the injector away from the heating element. |
| <b>Step 3</b> | Set the oven for the steam cooking function.   |

When you cook food such as chicken, duck, turkey or large fish, put the injector inside the food.

## 10. ADDITIONAL FUNCTIONS

### 10.1 Favourites

You can save your favourite settings, such as duration, temperature or heating function. They are available in the menu: Favourites. You can save 20 programmes.

#### Saving a programme

1. Turn on the oven.
2. Set a heating function or an automatic programme.
3. Press again and again until the display shows: SAVE.
4. Press OK to confirm.  
The display shows the first free memory position.
5. Press OK to confirm.
6. Enter the name of the programme.  
The first letter flashes.
7. Press or to change the letter.
8. Press OK.  
The next letter flashes.
9. Do step 7 again as necessary.
10. Press and hold OK to save.  
You can overwrite a memory position. When the display shows the first free memory position, press or and

press OK to overwrite an existing programme.

You can change the name of a programme in the menu: Edit Programme Name.

#### Activating the programme

1. Turn on the oven.
2. Select the menu: Favourites.
3. Press OK to confirm.
4. Select your favourite programme name.
5. Press OK to confirm.

You can press to go directly to menu: Favourites.

### 10.2 Using the Child Lock



When the Child Lock is on, the oven cannot be turned on accidentally.



If the Pyrolysis function works, the door locks automatically.

A message comes on in the display when you press any symbol.

1. Press to turn on the display.



- Press  and  at the same time until the display shows a message . To turn off the Child Lock function repeat step 2.

### 10.3 Function Lock

This function prevents an accidental change of the heating function. You can turn it on only when the oven works.

- Turn on the oven.
- Set a heating function or setting.
- Press  again and again until the display shows: Function Lock.
- Press **OK** to confirm.



 If the Pyrolysis function works, the door is locked and the symbol of a key comes on in the display.

To turn off the function, press . The display shows a message. Press  again and then **OK** to confirm.

 When you turn off the oven, the function also turns off.

### 10.4 Set + Go

The function lets you set a heating function (or a programme) and use it later with one press of any symbol.

- Turn on the oven.
- Set a heating function.
- Press  again and again until the display shows: Duration.
- Set the time.
- Press  again and again until the display shows: Set + Go.
- Press **OK** to confirm.



Press any symbol (except for ) to start the function: Set + Go. The set heating function starts.

When the heating function ends, a signal sounds.

- 
- Function Lock is on when the heating function works.
  - The menu: Basic Settings lets you turn the function: Set + Go on and off.

### 10.5 Automatic switch-off



For safety reasons the oven turns off after some time, if a heating function works and you do not change any settings.

 (°C)	 (h)
30 - 115	12.5
120 - 195	8.5
200 - 245	5.5
250 - maximum	3

The Automatic switch-off does not work with the functions: Light, Food Sensor, Duration, End Time.

### 10.6 Brightness of the display

There are two modes of display brightness:

 Day brightness	 Night brightness
It is on when the oven is turned on.	
It is on for 10 sec when you touch any sensor field during the night brightness mode.	
It is on when the oven is turned off and you set the function: Minute Minder. When the function ends, the display goes back to the night brightness.	When the oven is turned off, the display is in night brightness mode between 10 PM and 6 AM.



## 10.7 Cooling fan

When the oven operates, the cooling fan turns on automatically to keep the surfaces of the oven cool. If you turn off the oven, the cooling fan can continue to operate until the oven cools down.

## 10.8 Safety thermostat

Incorrect operation of the oven or defective components can cause

dangerous overheating. To prevent this, the oven has a safety thermostat which interrupts the power supply. The oven turns on again automatically when the temperature drops.

# 11. HINTS AND TIPS



Refer to Safety chapters.

## 11.1 Cooking recommendations

The oven has five shelf positions.

Count the shelf positions from the bottom of the oven floor.

Your oven may bake or roast differently to the oven you had before. The below tables provide you with the standard settings for temperature, cooking time and shelf position.

If you cannot find the settings for a special recipe, look for the similar one.

The oven has a special system which circulates the air and constantly recycles the steam. With this system you can cook in a steamy environment and keep the food soft inside and crusty outside. It decreases the cooking time and energy consumption.

### Baking cakes

Do not open the oven door before 3/4 of the set cooking time is up.

## 11.2 True Fan + Steam

Preheat the empty oven.

If you use two baking trays at the same time, keep one empty level between them.

### Cooking meat and fish

Use a deep pan for very fatty food to prevent the oven from stains that can be permanent.





Leave the meat for approximately 15 minutes before carving so that the juice does not seep out.





To prevent too much smoke in the oven during roasting, add some water into the deep pan. To prevent the smoke condensation, add water each time after it dries up.

### Cooking times





Cooking times depend on the type of food, its consistency, and volume.

Initially, monitor the performance when you cook. Find the best settings (heat setting, cooking time, etc.) for your cookware, recipes and quantities when you use this appliance.

 CAKES / PASTRIES	 (°C)	 (min)		
Tarts, preheating is not needed	175	30 - 40	2	Cake mould, Ø 26 cm



 <b>CAKES / PASTRIES</b>	 (°C)	 (min)		
Fruit cake, preheating is not needed	160	80 - 90	2	Cake mould, Ø 26 cm
Panettone	150 - 160	70 - 100	2	Cake mould, Ø 20 cm
Plum cake	160	40 - 50	2	Bread tin
Biscuits, preheating is not needed	150	20 - 35	3 (2 and 4)	Baking tray
Sweet buns	180 - 200	12 - 20	2	Baking tray
Brioche	180	15 - 20	3 (2 and 4)	Baking tray

Use the cake mould.



 <b>FLANS</b>	 (°C)	 (min)	
Vegetables filled	170 - 180	30 - 40	1
Lasagne	170 - 180	40 - 50	2
Potato gratin	160 - 170	50 - 60	1 (2 and 4)

Use the second shelf position.



Use the wire shelf.

 <b>MEAT</b>	 (°C)	 (min)
Roast pork, 1 kg	180	90 - 110
Veal, 1 kg	180	90 - 110
Roast beef, rare, 1 kg	210	45 - 50
Roast beef, medium, 1 kg	200	55 - 65
Roast beef, well done, 1 kg	190	65 - 75



Use the second shelf position.

	 (°C)	 (min)
Lamb leg, 1 kg	175	110 - 130
Whole chicken, 1 kg	200	55 - 65
Whole turkey, 4 kg	170	180 - 240
Whole duck, 2 - 2.5 kg	170 - 180	120 - 150
Rabbit, cut in pieces	170 - 180	60 - 90

Use the first shelf position.

	 (°C)	 (min)
Whole goose, 3 kg	160 - 170	150 - 200

Use the second shelf position.



 FISH	 (°C)	 (min)
Trout, 3 - 4 fish, 1.5 kg	180	25 - 35
Tuna, 4 - 6 fil- lets, 1.2 kg	175	35 - 50
Hake	200	20 - 30

### 11.3 Cooking in the dietary baking dish



Use the function: True Fan + Steam.

Use the second shelf position.



Set the temperature to 130°C.

 VEGETABLES	 (min)
Tomatoes	15
Aubergines	15 - 20
Broccoli, florets	20 - 25
Courgette, slices	20 - 25
Pepper, strips	20 - 25
Cauliflower, florets	25 - 30
Kohlrabi	25 - 30
Asparagus, white	25 - 35
Celery, slices	30 - 35
Fennel	30 - 35
Asparagus, green	35 - 45
Carrots	35 - 40



Set the temperature to 130°C.

 MEAT	 (min)
Poached chicken breast	25 - 35
Cooked ham	55 - 65
Kasseler	80 - 100

Set the temperature to 130°C.

 FISH	 (min)
Trout / Salmon fillet	25 - 30

Set the temperature to 130°C.



 SIDE DISHES	 (min)
Rice	35 - 40
Boiled potatoes, quar- tered	35 - 45
Polenta	40 - 45
Unpeeled potatoes, me- dium	50 - 60

### 11.4 Steam Regenerating







Preheat the empty oven.

Set the temperature to 130°C.







Use the second shelf position.

	 (min)
Pasta and sauce	10 - 15
Side dishes	10 - 15
One-Plate dish	10 - 15
Meat	10 - 15
Vegetables	10 - 15
Casseroles / Gratins	15 - 25

## 11.5 Baking and roasting







 <b>CAKES</b>	Conventional Cooking		True Fan Cooking		 (min)	
	 (°C)		 (°C)			
Whisked recipes	170	2	160	3 (2 and 4)	45 - 60	Cake mould
Shortbread dough	170	2	160	3 (2 and 4)	20 - 30	Cake mould
Buttermilk cheesecake	170	1	165	2	80 - 100	Cake mould, Ø 26 cm
Strudel	175	3	150	2	60 - 80	Baking tray
Jam tart	170	2	165	2	30 - 40	Cake mould, Ø 26 cm
Christmas cake, preheat the empty oven	160	2	150	2	90 - 120	Cake mould, Ø 20 cm
Plum cake, preheat the empty oven	175	1	160	2	50 - 60	Bread tin
Biscuits	140	3	140 - 150	3	25 - 45	Baking tray
Meringues	120	3	120	3	80 - 100	Baking tray
Meringues, preheat the empty oven, two levels	-	-	120	2 and 4	80 - 100	Baking tray
Buns, preheat the empty oven	190	3	190	3	12 - 20	Baking tray
Eclairs	190	3	170	3	25 - 35	Baking tray
Eclairs, two levels	-	-	170	2 and 4	35 - 45	Baking tray
Plate tarts	180	2	170	2	45 - 70	Cake mould, Ø 20 cm
Rich fruit cake	160	1	150	2	110 - 120	Cake mould, Ø 24 cm
Victoria sandwich	170	1	160	2	30 - 50	Cake mould, Ø 20 cm

Preheat the empty oven.

 <b>BREAD AND PIZZA</b>	Conventional Cooking		True Fan Cooking		 (min)	
	 (°C)		 (°C)			
White bread, 1 - 2 pieces, 0.5 kg each	190	1	190	1	60 - 70	-
Rye bread, preheating is not needed	190	1	180	1	30 - 45	Bread tin
Bread rolls, 6 - 8 rolls	190	2	180	2 (2 and 4)	25 - 40	Baking tray
Pizza	230 - 250	1	230 - 250	1	10 - 20	Baking tray / Deep pan
Scones	200	3	190	3	10 - 20	Baking tray





Preheat the empty oven.





Use the cake mould.







 <b>FLANS</b>	Conventional Cooking		True Fan Cooking		 (min)
	 (°C)		 (°C)		
Pasta flan, preheating is not needed	200	2	180	2	40 - 50
Vegetable flan, preheating is not needed	200	2	175	2	45 - 60
Quiches	180	1	180	1	50 - 60
Lasagne	180 - 190	2	180 - 190	2	25 - 40
Cannelloni	180 - 190	2	180 - 190	2	25 - 40

Use the second shelf position.





Use the wire shelf.

 <b>MEAT</b>	Conventional Cooking		True Fan Cooking		 (min)
	 (°C)		 (°C)		
Beef	200		190		50 - 70

 MEAT	Conventional Cooking	True Fan Cooking	 (min)
	 (°C)	 (°C)	
Pork	180	180	90 - 120
Veal	190	175	90 - 120
English roast beef, rare	210	200	50 - 60
English roast beef, medium	210	200	60 - 70
English roast beef, well done	210	200	70 - 75

 MEAT	Conventional Cooking		True Fan Cooking		 (min)
	 (°C)		 (°C)		
Pork shoulder, with rind	180	2	170	2	120 - 150
Pork shin, 2 pieces	180	2	160	2	100 - 120
Leg of lamb	190	2	175	2	110 - 130
Whole chicken	220	2	200	2	70 - 85
Whole turkey	180	2	160	2	210 - 240
Whole duck	175	2	220	2	120 - 150
Whole goose	175	2	160	1	150 - 200
Rabbit, cut in pieces	190	2	175	2	60 - 80
Hare, cut in pieces	190	2	175	2	150 - 200
Whole pheasant	190	2	175	2	90 - 120





Use the second shelf position.

 FISH	Conventional Cooking	True Fan Cooking	 (min)
	 (°C)	 (°C)	
Trout / Sea bream, 3 - 4 fish	190	175	40 - 55
Tuna / Salmon, 4 - 6 fillets	190	175	35 - 60

## 11.6 Bread Baking

Preheat the empty oven.





Use the second shelf position unless specified otherwise.

 BREAD	 (kg)	 (°C)	 (min)	
White bread, 1 - 2 pieces, 0.5 kg for each	1	180 - 190	45 - 60	-
Bread rolls, 6 - 8 rolls	0.5	190 - 210	20 - 30	Baking tray, use the second and the fourth shelf position
Rye bread, 1 - 2 pieces, 0.5 kg for each	1	180 - 200	50 - 70	-
Focaccia	-	190 - 210	20 - 25	Baking tray

## 11.7 Crispy baking with: Pizza Function

Preheat the empty oven.

Use the first shelf position unless specified otherwise.





 PIZZA	 (°C)	 (min)	
Pizza, thin crust	200 - 220	15 - 25	Baking tray
Pizza, thick crust	200 - 220	20 - 30	Baking tray
Mini pizza	200 - 220	15 - 20	Baking tray
Apple pie	150 - 170	50 - 70	Cake mould, Ø 20 cm
Tarts	170 - 190	35 - 50	Cake mould, Ø 26 cm
Onion tart, use the second shelf position	200 - 220	20 - 30	Baking tray





## 11.8 Grill

Preheat the empty oven.

Use the fourth shelf position.

Grill with the maximum temperature setting.

 GRILL	 (kg)	 (min) 1st side	 (min) 2nd side
Fillet steaks, 4 pieces	0.8	12 - 15	12 - 14



 <b>GRILL</b>	 (kg)	 (min) 1st side	 (min) 2nd side
Beef steak, 4 pieces	0.6	10 - 12	6 - 8
Sausages, 8	-	12 - 15	10 - 12
Pork chops, 4 pieces	0.6	12 - 16	12 - 14
Chicken, half, 2	1	30 - 35	25 - 30
Kebabs, 4	-	10 - 15	10 - 12
Chicken breast, 4 pieces	0.4	12 - 15	12 - 14
Burgers, 6	0.6	20 - 30	-
Fish fillet, 4 pieces	0.4	12 - 14	10 - 12
Toasted sandwiches, 4 - 6	-	5 - 7	-
Toast, 4 - 6	-	2 - 4	2 - 3



## 11.9 Turbo Grilling



Preheat the empty oven.



Use the first or the second shelf position.



To calculate the roasting time multiple the time given in the table below by the centimetres of thickness of the fillet.

 <b>BEEF</b>	 (°C)	 (min)
Roast beef or fillet, rare	190 - 200	5 - 6
Roast beef or fillet, medium	180 - 190	6 - 8
Roast beef or fillet, well done	170 - 180	8 - 10



 <b>PORK</b>	 (°C)	 (min)
Shoulder / Neck / Ham joint, 1 - 1.5 kg	160 - 180	90 - 120
Chops / Spare rib, 1 - 1.5 kg	170 - 180	60 - 90

 <b>PORK</b>	 (°C)	 (min)
Meatloaf, 0.75 - 1 kg	160 - 170	50 - 60
Pork knuckle, precooked, 0.75 - 1 kg	150 - 170	90 - 120



 <b>VEAL</b>	 (°C)	 (min)
Roast veal, 1 kg	160 - 180	90 - 120
Veal knuckle, 1.5 - 2 kg	160 - 180	120 - 150

 <b>LAMB</b>	 (°C)	 (min)
Lamb leg / Roast lamb, 1 - 1.5 kg	150 - 170	100 - 120
Lamb saddle, 1 - 1.5 kg	160 - 180	40 - 60



 <b>POULTRY</b>	 (°C)	 (min)
Poultry, portions, 0.2 - 0.25 kg each	200 - 220	30 - 50
Chicken, half, 0.4 - 0.5 kg each	190 - 210	35 - 50
Chicken, pou-lard, 1 - 1.5 kg	190 - 210	50 - 70
Duck, 1.5 - 2 kg	180 - 200	80 - 100
Goose, 3.5 - 5 kg	160 - 180	120 - 180
Turkey, 2.5 - 3.5 kg	160 - 180	120 - 150
Turkey, 4 - 6 kg	140 - 160	150 - 240





  

 <b>FISH (STEAMED)</b>	 (°C)	 (min)
Whole fish, 1 - 1.5 kg	210 - 220	40 - 60





## 11.10 Slow Cooking

This function allows you to prepare lean, tender meat and fish. It is not applicable for: poultry, fatty roast pork, pot roast. Food Sensor temperature should not be higher than 65 °C.

1. Sear the meat for 1 - 2 minutes on each side in a pan over high heat.
2. Put the meat in the roasting pan or directly on the wire shelf. Put a tray below the wire shelf to collect fat. Always cook without a lid while using this function.
3. Use: Food Sensor. Refer to "Using the accessories" chapter, How to use: Food Sensor.
4. Select the function: Slow Cooking. You can set the temperature between 80 °C and 150 °C for the first 10 minutes. The default is 90 °C. Set the temperature for Food Sensor. After 10 minutes, the oven automatically lowers the temperature to 80 °C.

 <b>Set the temperature to 120 °C.</b>		 (kg)	 (min)	
Steaks	0.2 - 0.3	20 - 40	3	
Fillet of beef	1 - 1.5	90 - 150	3	
Roast beef	1 - 1.5	120 - 150	1	
Roast veal	1 - 1.5	120 - 150	1	

## 11.11 Defrost

	 (kg)	 Defrosting time (min)	 Further defrost- ing time (min)	
Chicken	1	100 - 140	20 - 30	Place chicken on an upturned saucer placed on a large plate. Turn halfway through.
Meat	1	100 - 140	20 - 30	Turn halfway through.
	0.5	90 - 120		
Cream	2 x 0.2	80 - 100	10 - 15	Cream can also be whipped when still slightly frozen in places.
Trout	0.15	25 - 35	10 - 15	-
Strawberries	0.3	30 - 40	10 - 20	-
Butter	0.25	30 - 40	10 - 15	-
Gateau	1.4	60	60	-

## 11.12 Preserving

Use the function Bottom Heat.

Use only preserve jars of the same dimensions available on the market.

Do not use jars with twist-off and bayonet type lids or metal tins.

Use the first shelf position.

Put no more than six one-litre preserve jars on the baking tray.



Fill the jars equally and close with a clamp.

The jars cannot touch each other.



Put approximately 1/2 litre of water into the baking tray to give sufficient moisture in the oven.



When the liquid in the jars starts to simmer (after approximately 35 - 60 minutes with one-litre jars), stop the oven or decrease the temperature to 100 °C (see the table).

Set the temperature to 160 - 170 °C.



 SOFT FRUIT	 (min) Cooking time until simmering
Strawberries / Blueberries / Raspberries / Ripe gooseberries	35 - 45

 STONE FRUIT	 (min) Cooking time until simmering	 (min) Continue to cook at 100 °C
Peaches / Quinces / Plums	35 - 45	10 - 15

 VEGETABLES	 (min) Cooking time until simmering	 (min) Continue to cook at 100 °C
Carrots	50 - 60	5 - 10
Cucumbers	50 - 60	-
Mixed pickles	50 - 60	5 - 10
Kohlrabi / Peas / Asparagus	50 - 60	15 - 20

For 2 trays use the first and fourth shelf position.

 VEGETABLES	 (°C)	 (h)
Beans	60 - 70	6 - 8
Peppers	60 - 70	5 - 6
Vegetables for soup	60 - 70	5 - 6
Mushrooms	50 - 60	6 - 8
Herbs	40 - 50	2 - 3



Set the temperature to 60 - 70 °C.

### 11.13 Dehydrating - True Fan Cooking

Cover trays with grease proof paper or baking parchment.



For a better result, stop the oven halfway through the drying time, open the door and let it cool down for one night to complete the drying.

For 1 tray use the third shelf position.

 FRUIT	 (h)
Plums	8 - 10
Apricots	8 - 10
Apple slices	6 - 8
Pears	6 - 9



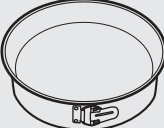

### 11.14 Moist Fan Baking - recommended accessories





Use the dark and non-reflective tins and containers. They have better heat absorption than the light colour and reflective dishes.

			
<b>Pizza pan</b>	<b>Baking dish</b>	<b>Ramekins</b>	<b>Flan base tin</b>
Dark, non-reflective 28 cm diameter	Dark, non-reflective 26 cm diameter	Ceramic 8 cm diameter, 5 cm height	Dark, non-reflective 28 cm diameter

### 11.15 Moist Fan Baking







For the best results follow suggestions listed in the table below.







		 (°C)		 (min)
Sweet rolls, 16 pieces	baking tray or dripping pan	180	2	20 - 30
Rolls, 9 pieces	baking tray or dripping pan	180	2	30 - 40
Pizza, frozen, 0.35 kg	wire shelf	220	2	10 - 15
Swiss roll	baking tray or dripping pan	170	2	25 - 35
Brownie	baking tray or dripping pan	175	3	25 - 30
Soufflé, 6 pieces	ceramic ramekins on wire shelf	200	3	25 - 30
Sponge flan base	flan base tin on wire shelf	180	2	15 - 25
Victoria sandwich	baking dish on wire shelf	170	2	40 - 50
Poached fish, 0.3 kg	baking tray or dripping pan	180	3	20 - 25
Whole fish, 0.2 kg	baking tray or dripping pan	180	3	25 - 35
Fish fillet, 0.3 kg	pizza pan on wire shelf	180	3	25 - 30
Poached meat, 0.25 kg	baking tray or dripping pan	200	3	35 - 45
Shashlik, 0.5 kg	baking tray or dripping pan	200	3	25 - 30
Cookies, 16 pieces	baking tray or dripping pan	180	2	20 - 30
Macaroons, 24 pieces	baking tray or dripping pan	180	2	25 - 35
Muffins, 12 pieces	baking tray or dripping pan	170	2	30 - 40
Savory pastry, 20 pieces	baking tray or dripping pan	180	2	25 - 30
Short crust biscuits, 20 pieces	baking tray or dripping pan	150	2	25 - 35
Tartlets, 8 pieces	baking tray or dripping pan	170	2	20 - 30

		 (°C)		 (min)
Vegetables, poached, 0.4 kg	baking tray or dripping pan	180	3	35 - 45
Vegetarian omelette	pizza pan on wire shelf	200	3	25 - 30
Mediterranean vegetables, 0.7 kg	baking tray or dripping pan	180	4	25 - 30

## 11.16 Information for test institutes

Tests according to IEC 60350-1.

				 (°C)	 (min)	
Small cakes, 20 per tray	Conventional Cooking	Baking tray	3	170	20 - 30	-
Small cakes, 20 per tray	True Fan Cooking	Baking tray	3	150 - 160	20 - 35	-
Small cakes, 20 per tray	True Fan Cooking	Baking tray	2 and 4	150 - 160	20 - 35	-
Apple pie, 2 tins Ø20 cm	Conventional Cooking	Wire shelf	2	180	70 - 90	-
Apple pie, 2 tins Ø20 cm	True Fan Cooking	Wire shelf	2	160	70 - 90	-
Sponge cake, cake mould Ø26 cm	Conventional Cooking	Wire shelf	2	170	40 - 50	Preheat the oven for 10 minutes.

				 (°C)	 (min)	
Sponge cake, cake mould Ø26 cm	True Fan Cooking	Wire shelf	2	160	40 - 50	Preheat the oven for 10 minutes.
Sponge cake, cake mould Ø26 cm	True Fan Cooking	Wire shelf	2 and 4	160	40 - 60	Preheat the oven for 10 minutes.
Short bread	True Fan Cooking	Baking tray	3	140 - 150	20 - 40	-
Short bread	True Fan Cooking	Baking tray	2 and 4	140 - 150	25 - 45	-
Short bread	Conventional Cooking	Baking tray	3	140 - 150	25 - 45	-
Toast, 4 - 6 pieces	Grill	Wire shelf	4	max.	2 - 3 minutes first side; 2 - 3 minutes second side	Preheat the oven for 3 minutes.
Beef burger, 6 pieces, 0.6 kg	Grill	Wire shelf and dripping pan	4	max.	20 - 30	Put the wire shelf on the fourth level and the dripping pan on the third level of the oven. Turn the food halfway through the cooking time. Preheat the oven for 3 minutes.

## 12. CARE AND CLEANING



### WARNING!

Refer to Safety chapters.

## 12.1 Notes on cleaning



### Cleaning Agents

Clean the front of the oven with a soft cloth with warm water and a mild detergent.

Use a cleaning solution to clean metal surfaces.

Clean stains with a mild detergent.



### Everyday Use

Clean the cavity after each use. Fat accumulation or other residue may cause fire.

Moisture can condense in the oven or on the door glass panels. To decrease the condensation, let the oven work for 10 minutes before cooking. Do not store the food in the oven for longer than 20 minutes. Dry the cavity with a soft cloth after each use.



### Accessories

Clean all accessories after each use and let them dry. Use a soft cloth with warm water and a mild detergent. Do not clean the accessories in a dishwasher.

Do not clean the non-stick accessories using abrasive cleaner or sharp-edged objects.

## 12.2 How to remove: Shelf supports

Remove the shelf supports to clean the oven.

**Step 1** Turn off the oven and wait until it is cold.

**Step 2** Pull the front of the shelf support away from the side wall.

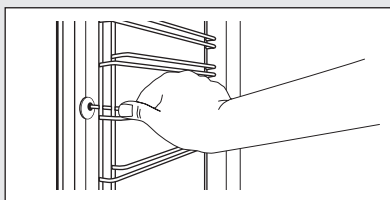

**Step 3** Pull the rear end of the shelf support away from the side wall and remove it.

**Step 4** Install the shelf supports in the opposite sequence.

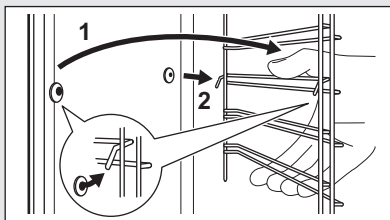

## 12.3 How to use: Pyrolytic Cleaning

Clean the oven with Pyrolytic Cleaning.



**WARNING!**  
There is a risk of burns.



**CAUTION!**  
If there are other appliances installed in the same cabinet, do not use them at the same time as this function. It can cause damage to the oven.

Before the Pyrolytic Cleaning:		
Turn off the oven and wait until it is cold.	Remove all accessories.	Clean the oven floor and the inner door glass with warm water, a soft cloth and a mild detergent.

Step 1	Step 2	Step 3
Turn on the oven.	Press: Menu / Pyrolysis.	Set the cleaning mode. Press: OK.

Option	Cleaning mode	Duration
Quick	Light cleaning	1 h
Normal	Normal cleaning	1 h 30 min
Intense	Thorough cleaning	2 h 30 min

**i** When the cleaning starts, the oven door is locked and the lamp is off.

To stop the cleaning before it is completed, turn off the oven.  
The oven stays locked until it is cold.

When the cleaning ends:		
Turn off the oven and wait until it is cold.	Clean the cavity with a soft cloth.	Remove the residue from the bottom of the cavity.

## 12.4 How to clean: Water tank

<b>Step 1</b>	Turn off the oven.
<b>Step 2</b>	Place a deep pan below the steam inlet.
<b>Step 3</b>	Pour water into the water drawer: 850 ml. Add citric acid: 5 teaspoons. Wait for 60 min.
<b>Step 4</b>	Turn on the oven and set the function: True Fan + Steam. Set the temperature to 230 °C. Turn off the oven after 25 min and wait until it is cold.
<b>Step 5</b>	Turn on the oven and set the function: True Fan + Steam. Set the temperature between 130 and 230 °C. Turn off the oven after 10 minutes and wait until it is cold.







**i** To prevent limestone residue empty the water tank after each steam cooking.

#### When the cleaning ends:

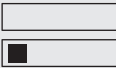
Turn off the oven.	Empty the water tank. Refer to Daily use, "Emptying the water tank" chapter.	Rinse the water tank and clean the remaining limestone residue with a soft cloth.	Clean the drain pipe with warm water and a mild detergent.
--------------------	--	---	--

The table below shows water hardness range (dH) with the corresponding level of calcium deposit and the quality of water. When water hardness exceeds level 4, fill the water drawer with bottled water.

Water hardness		Test strip	Calcium deposit (mg/l)	Water classification	Clean the water tank every
Level	dH				
1	0 - 7		0 - 50	soft	75 cycles - 2.5 months
2	8 - 14		51 - 100	moderately hard	50 cycles - 2 months
3	15 - 21		101 - 150	hard	40 cycles - 1.5 months
4	22 - 28		over 151	very hard	30 cycles - 1 month

## 12.5 How to remove and install: Door

The oven door has three glass panels. You can remove the oven door and the internal glass panels to clean them. Read the whole "Removing and installing door" instruction before you remove the glass panels.



### CAUTION!

Do not use the oven without the glass panels.

**Step 1** Fully open the door and find the hinge to the right side of the door.

**Step 2** Use a screwdriver to lift and turn the right side hinge lever.

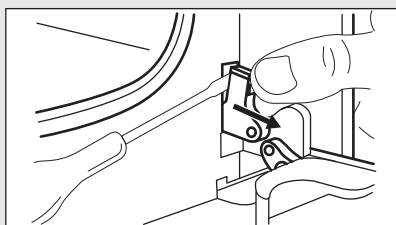

<b>Step 3</b>	Find the hinge to the left side of the door.	
<b>Step 4</b>	Lift and turn the lever fully on the left hinge.	
<b>Step 5</b>	Close the oven door halfway to the first opening position. Then lift and pull forward and remove the door from its seat.	
<b>Step 6</b>	Put the door on a soft cloth on a stable surface.	
<b>Step 7</b>	Hold the door trim (B) on the top edge of the door at the two sides and push inwards to release the clip seal.	
<b>Step 8</b>	Pull the door trim to the front to remove it.	
<b>Step 9</b>	Hold the door glass panels by their top edge and carefully pull them out one by one. Start from the top panel. Make sure the glass slides out of the supports completely.	
<b>Step 10</b>	Clean the glass panels with water and soap. Dry the glass panels carefully. Do not clean the glass panels in the dishwasher.	
<b>Step 11</b>	After cleaning, install the glass panels and the oven door.	

Make sure that you put the glass panels (A and B) back in the correct sequence. Check for the symbol / printing on the side of the glass panel, each of the glass panels looks different to make the disassembly and assembly easier. When installed correctly the door trim clicks. Make sure that you install the middle panel of glass in the seats correctly.

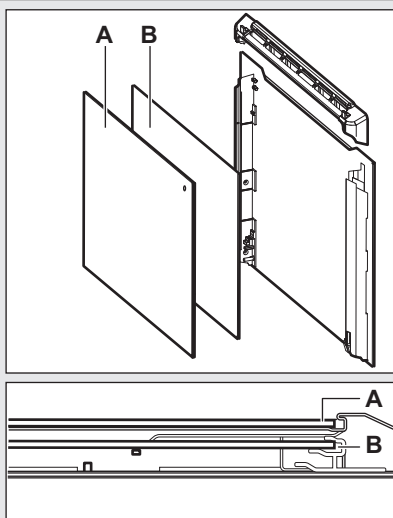

## 12.6 How to replace: Lamp



**WARNING!**  
Risk of electric shock.  
The lamp can be hot.

Always hold the halogen lamp with a cloth to prevent grease residue from burning on the lamp.

Before you replace the lamp:		
Step 1	Step 2	Step 3
Turn off the oven. Wait until the oven is cold.	Disconnect the oven from the mains.	Put a cloth on the bottom of the cavity.

## Back lamp

<b>Step 1</b>	Turn the glass cover to remove it.
<b>Step 2</b>	Clean the glass cover.
<b>Step 3</b>	Replace the lamp with a suitable 300 °C heat-resistant lamp.
<b>Step 4</b>	Install the glass cover.

## 13. TROUBLESHOOTING



**WARNING!**  
Refer to Safety chapters.

## 13.1 What to do if...

<b>Problem</b>	<b>Possible cause</b>	<b>Remedy</b>
You cannot activate or operate the oven.	The oven is not connected to an electrical supply or it is connected incorrectly.	Check if the oven is correctly connected to the electrical supply (refer to the connection diagram if available).
The oven does not heat up.	The oven is turned off.	Turn on the oven.
The oven does not heat up.	The clock is not set.	Set the clock.
The oven does not heat up.	The necessary settings are not set.	Make sure that the settings are correct.
The oven does not heat up.	The automatic switch-off is on.	Refer to "Automatic switch-off".
The oven does not heat up.	The Child Lock is on.	Refer to "Using the Child Lock".
The oven does not heat up.	The door is not closed correctly.	Fully close the door.
The oven does not heat up.	The fuse is blown.	Make sure that the fuse is the cause of the malfunction. If the fuse is blown again and again, contact a qualified electrician.
The lamp does not operate.	The lamp is defective.	Replace the lamp.
The food sensor does not operate.	The plug of the food sensor is not correctly installed into the socket.	Put the plug of the food sensor as far as possible into the socket.
There is water inside the oven.	There is too much water in the tank.	Turn off the oven and wipe the water with a cloth or sponge.
The steam cooking does not work.	There is no water in the tank.	Fill the water tank.
The steam cooking does not work.	Lime obstructs the hole.	Check the steam inlet opening. Remove the lime.
It takes more than three minutes to empty the water tank or the water leaks from the steam inlet opening.	There are lime deposits in the oven.	Clean the water tank. Refer to "Cleaning the water tank".

Problem	Possible cause	Remedy
The display shows F111.	The plug of the food sensor is not correctly installed into the socket.	Put the plug of the food sensor as far as possible into the socket.
The display shows an error code that is not in this table.	There is an electrical fault.	<ul style="list-style-type: none"> <li>• Turn off the oven with the house fuse or the safety switch in the fuse box and turn it on again.</li> <li>• If the display shows the error code again, contact the Customer Care Department.</li> </ul>
Steam and condensation settle on the food and in the cavity of the oven.	You left the dish in the oven for too long.	Do not leave the dishes in the oven for longer than 15 - 20 minutes after the cooking process ends.
The appliance is activated and does not heat up. The fan does not operate. The display shows "Demo".	The demo mode is activated.	Refer to "Daily Use chapter, Basic Settings.

## 13.2 Service data

If you cannot find a solution to the problem yourself, contact your dealer or an Authorised Service Centre.

The necessary data for the service centre is on the rating plate. The rating plate is on the front frame of the oven cavity. Do not remove the rating plate from the oven cavity.

We recommend that you write the data here:	
Model (MOD.)	.....
Product number (PNC)	.....
Serial number (S.N.)	.....

# 14. ENERGY EFFICIENCY

## 14.1 Energy saving



The oven has features which help you save energy during everyday cooking.

Make sure that the oven door is closed when the oven operates. Do not open the oven door too often during cooking. Keep the door gasket clean and make sure it is well fixed in its position.

Use metal cookware to improve energy saving.

When possible, do not preheat the oven before cooking.

Keep breaks between baking as short as possible when you prepare a few dishes at one time.

### Cooking with fan

When possible, use the cooking functions with fan to save energy.

### Residual heat

If a programme with the Duration or End Time selection is activated and the cooking time is longer than 30 min, the

heating elements automatically turn off earlier in some oven functions.

The fan and lamp continue to operate. When you turn off the oven, the display shows the residual heat. You can use that heat to keep the food warm.

When the cooking duration is longer than 30 min, reduce the oven temperature to minimum 3 - 10 min before the end of cooking. The residual heat inside the oven will continue to cook.

Use the residual heat to warm up other dishes.

#### **Keep food warm**

Choose the lowest possible temperature setting to use residual heat and keep a

meal warm. The residual heat indicator or temperature appears on the display.

#### **Cooking with the lamp off**



Turn off the lamp during cooking. Turn it on only when you need it.

#### **Moist Fan Baking**

Function designed to save energy during cooking.

When you use this function the lamp automatically turns off after 30 sec. You may turn on the lamp again but this action will reduce the expected energy savings.

## 15. ENVIRONMENTAL CONCERNS

Recycle materials with the symbol . Put the packaging in relevant containers to recycle it. Help protect the environment and human health by recycling waste of electrical and electronic appliances. Do not dispose of appliances marked with the symbol  with the household waste. Return the

product to your local recycling facility or contact your municipal office.

Being ensured permissible content limitation of some toxic chemicals (RoHS compliant).

### **RoHS**

Compliant



[www.electrolux.com/shop](http://www.electrolux.com/shop)



867360991-A-132021

