

Canon

EOS R7



Advanced User Guide

E

Contents

Introduction.	10
Package Contents.	11
Supplemental Information.	13
Compatible Accessories.	14
Instruction Manuals.	15
Quick Start Guide.	16
About This Guide.	20
Compatible Cards.	22
Safety Instructions.	23
Handling Precautions.	26
Part Names.	29
Software.	37
Preparation and Basic Operations.	41
Charging the Battery.	42
Inserting/Removing Batteries.	45
Inserting/Removing Cards.	48
Using the Screen.	54
Turning on the Power.	56
Attaching and Detaching RF/RF-S Lenses.	60
Attaching and Detaching EF/EF-S Lenses.	65
Multi-Function Shoe.	69
Using the Viewfinder.	71
Basic Operations.	72
Menu Operations and Settings.	84
Quick Control.	90
Touch-Screen Operation.	92
Basic Zone.	94
A+: Fully Automatic Shooting (Scene Intelligent Auto).	95
Special Scene Mode.	103
Portrait Mode.	106

Group Photo Mode	107
Landscape Mode	108
Panoramic Shot Mode	109
Sports Mode	111
Kids Mode	112
Panning Mode	113
Close-up Mode	115
Food Mode	116
Night Portrait Mode	117
Handheld Night Scene Mode	118
HDR Backlight Control Mode	119
Silent Shutter Mode	120
Creative Filters Mode	121
Creative Zone	128
Fv: Flexible-Priority AE	129
P: Program AE	132
Tv: Shutter-Priority AE	134
Av: Aperture-Priority AE	137
M: Manual Exposure	141
B: Long (Bulb) Exposures	144
Shooting and Recording	148
Still Photo Shooting	149
Tab Menus: Still Photo Shooting	151
Image Quality	159
Dual Pixel RAW	165
Still Image Aspect Ratio	167
Auto Exposure Bracketing (AEB)	169
Manual Exposure Compensation	171
Exposure Lock (AE Lock)	173
ISO Speed Settings for Still Photos	175
HDR Shooting	184
HDR Mode	186

Auto Lighting Optimizer	190
Highlight Tone Priority	192
Anti-Flicker Shooting	194
Shooting with Speedlites	196
Flash Function Settings	200
Metering Mode	214
White Balance	216
White Balance Correction	226
Color Space	230
Picture Style Selection	231
Picture Style Customization	235
Picture Style Registration	239
Clarity	242
Shooting Creative Filters	243
Lens Aberration Correction	248
Long Exposure Noise Reduction	255
High ISO Speed Noise Reduction	257
Dust Delete Data Acquisition	259
Multiple Exposures	263
RAW Burst Mode	272
Focus Bracketing	275
Interval Timer Shooting	281
Silent Shutter Function	285
Shutter Mode	286
Releasing Shutter without Card	288
Image Stabilizer (IS Mode)	289
Auto Level	292
Customizing Quick Controls	293
Shooting with the Touch Shutter	297
Image Review	299
High-Speed Display	302
Metering Timer	304
Display Simulation	305

Optical Viewfinder Simulation	307
Shooting Information Display	309
Reverse Display	321
Viewfinder Display Format	322
Display Performance	323
General Still Photo Shooting	325
Movie Recording	328
Tab Menus: Movie Recording	329
Movie Recording	335
Movie Recording Size	358
High Frame Rate	366
Digital Zoom	367
Sound Recording	369
Canon Log Settings	373
Time-Lapse Movies	380
Movie Self-Timer	394
Image Stabilizer (IS Mode)	395
Shutter Button Function for Movies	398
Zebra Settings	400
Time Code	403
Other Menu Functions	410
General Movie Recording Precautions	420
AF/Drive	424
Tab Menus: AF (Still Photos)	425
Tab Menus: AF (Movie Recording)	431
AF Operation	436
Movie Servo AF	442
Selecting the AF Area	445
Preview AF	470
Touch & Drag AF Settings	471
Manual Focus	474
Servo AF Characteristics	482
Customizing AF Functions	493

Selecting the Drive Mode.	505
Using the Self-Timer.	508
Remote Control Shooting.	510
Customizing Operation.	514
Playback.	520
Tab Menus: Playback.	522
Image Playback.	527
Magnified Image Display.	532
Index Display (Multiple-Image Display).	540
Movie Playback.	543
Editing a Movie's First and Last Scenes.	547
Frame Extraction from 4K Movies or 4K Time-Lapse Movies.	550
Playback on a TV Set.	553
Protecting Images.	555
Erasing Images.	559
Rotating Still Photos.	566
Changing Movie Orientation Information.	568
Rating Images.	570
Copying Images.	576
Print Ordering (DPOF).	584
Photobook Set-up.	589
RAW Image Processing.	594
Creative Assist.	603
Quick Control RAW Processing.	606
Cloud RAW Image Processing.	608
Playback Creative Filters.	618
Resizing JPEG/HEIF Images.	622
Cropping JPEG/HEIF Images.	624
Converting HEIF to JPEG.	627
Slide Show.	629
Setting Image Search Conditions.	632
Resuming from Previous Playback.	636
Browsing Images with the Main Dial.	637

Customizing Playback Information Display	639
Displaying the Highlight Alert.	643
AF Point Display.	644
Playback Grid.	645
Movie Play Count.	646
Still Photo Extraction from RAW Burst Images.	648
HDMI HDR Output.	651
Wireless Features.	652
Tab Menus: Wireless Features.	654
Wi-Fi/Bluetooth Connection.	655
Connecting to a Smartphone.	657
Connecting to a Computer via Wi-Fi.	697
Connecting to a Printer via Wi-Fi.	704
Sending Images to a Web Service.	718
Streaming Images.	724
Wi-Fi Connection via Access Points.	732
Connecting to a Wireless Remote Control.	740
Reconnecting via Wi-Fi/Bluetooth.	745
Registering Multiple Connection Settings.	747
Airplane Mode.	748
Wi-Fi Settings.	749
Bluetooth Settings.	750
Nickname.	751
GPS Device Settings.	752
Changing or Deleting Connection Settings.	757
Resetting Communication Settings.	759
View Info Screen.	760
Virtual Keyboard Operations.	761
Responding to Error Messages.	762
Wireless Communication Function Precautions.	769
Security.	771
Checking Network Settings.	772
Wireless Communication Status.	773

Set-up	775
Tab Menus: Set-up	777
Selecting Cards for Recording/Playback	780
Folder Settings	787
File Numbering	791
File Naming	796
Card Formatting	799
Auto Rotate	802
Adding Orientation Information to Movies	804
Date/Time/Zone	805
Language	808
Video System	809
Help	810
Shooting Mode Guide	813
Beeps	815
Volume	816
Headphones	817
Power Saving	820
Screen and Viewfinder Display	822
Screen Brightness	824
Viewfinder Brightness	825
Screen and Viewfinder Color Tone	826
Fine-Tuning Viewfinder Color Tone	827
UI Magnification	828
HDMI Resolution	829
Touch Control	830
Multi-Function Lock	831
Focus Mode Switch (AF/MF)	832
Shutter at Shutdown	833
Sensor Cleaning	834
App Selection for USB Connections	839
Resetting the Camera	840
Custom Shooting Mode (C1–C3)	842

Battery Information.	845
Copyright Information.	852
Other Information.	855
Custom Functions/My Menu.	856
Tab Menus: Custom Functions.	857
Custom Function Setting Items.	860
Tab Menus: My Menu.	886
Registering My Menu.	887
Reference.	894
Importing Images to a Computer.	895
Importing Images to a Smartphone.	898
Using a USB Power Adapter to Charge/Power the Camera.	901
Troubleshooting Guide.	904
Error Codes.	924
ISO Speed in Movie Recording.	925
Information Display.	926
Specifications.	937
Trademarks and Licensing.	958

Introduction

Before starting to shoot, be sure to read the following

To avoid shooting problems and accidents, first read the [Safety Instructions](#) and [Handling Precautions](#). Also read this Advanced User Guide carefully to ensure that you use the camera correctly.

Take some test shots, and understand about product liability

After shooting, play images back and check whether they have been properly recorded. If the camera or memory card is faulty and images cannot be recorded or transferred to a computer, Canon cannot be held liable for any loss or inconvenience caused.

Copyrights

Copyright laws in some countries prohibit the unauthorized use of images recorded with the camera (or music/images with music transferred to the memory card) for purposes other than personal enjoyment. Also be aware that certain public performances, exhibitions, etc. may prohibit photography even for private enjoyment.

- [Package Contents](#)
- [Supplemental Information](#)
- [Compatible Accessories](#)
- [Instruction Manuals](#)
- [Quick Start Guide](#)
- [About This Guide](#)
- [Compatible Cards](#)
- [Safety Instructions](#)
- [Handling Precautions](#)
- [Part Names](#)
- [Software](#)

Package Contents

Before use, make sure the following items are included in the package. If anything is missing, contact your dealer.



Camera

(with body cap (Camera Cover R-F-5) and shoe cover)



Battery Pack LP-E6NH

(with protective cover)

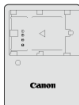

Battery Charger LC-E6/LC-E6E*



Strap

* Battery Charger LC-E6 or LC-E6E is provided. (The LC-E6E comes with a power cord.)

- The camera does not come with a memory card (📁), interface cable, or HDMI cable.
- If you purchased a Lens Kit, check that the lenses are included.
- Be careful not to lose any of these items.
- No software CD-ROM is included. Software (📁) can be downloaded from the Canon website.

 **Caution**

- When you need Lens Instruction Manuals, download them from the Canon website ([🔗](#)).
Lens Instruction Manuals (PDF files) are for lenses sold separately, and when a lens kit is purchased, some accessories included with the lens may not match those listed in the Lens Instruction Manual.

Supplemental Information

Refer to the following website for information on lenses compatible with camera features, and for supplemental information about the camera.

- <https://cam.start.canon/H001/>



Compatible Accessories

Check the following website for details on compatible accessories.

- <https://cam.start.canon/H002/>



Instruction Manuals



The included Instruction Manual provides basic camera instructions.

- **Advanced User Guide**

Complete instructions are provided in this Advanced User Guide. For the latest Advanced User Guide, refer to the following website.
<https://cam.start.canon/C005/>



- **Lens/Software Instruction Manual**

Download from the following website and refer to the supplemental information.
<https://cam.start.canon/>



 **Note**

- Select [: **Manual/software URL**] to display the QR code on the camera screen.

1. Insert the battery (🔋).

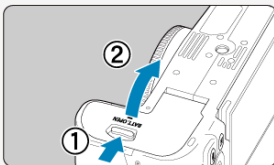

- Upon purchase, charge the battery to start using (🔋).

2. Insert the card (💳).

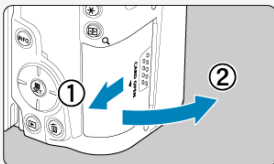

- You can insert two cards.

3. Attach the lens (🔍).

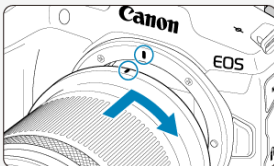

- Align the red mount index on the lens with the red mount index on the camera to attach the lens.

4. Set the focus mode to < AF > (☑).

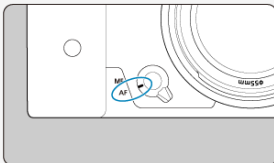

5. Set the power switch to < ON > (☑).

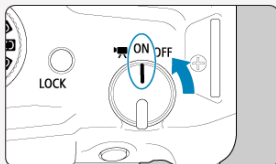

6. Flip out the screen (☑).

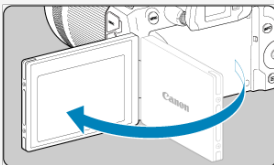

- When the date/time/zone setting screen is displayed, see [Date/Time/Zone](#).

7. Set the Mode dial to <A+> (☑).

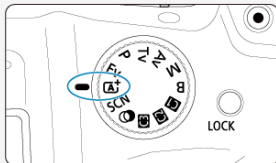

- All the necessary camera settings is set automatically.

8. Focus on the subject (☑).



- A tracking frame [] for AF appears over any face detected.
- Press the shutter button halfway, and the camera will focus on the subject.

9. Take the picture (☑).

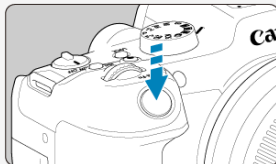

- Press the shutter button completely to take the picture.

10. Review the picture.

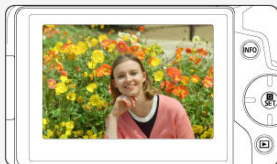









- The image just captured will be displayed for approx. 2 sec. on the screen.
- To display the image again, press the <▶> button (📺).

About This Guide







 [Icons in This Guide](#)

 [Basic Assumptions for Operational Instructions and Sample Photos](#)









Icons in This Guide

	Indicates the Main dial.
	Indicates the Quick control dial.
	Indicates the Multi-controller.
	Indicates the direction to press the cross keys (<  >).
	Indicates the lens control ring.
	Indicates the Quick Control/Set button.
	Indicates the duration (in * seconds) of the operation for the button you pressed, as timed after you release the button.

- In addition to the above, the icons and symbols used on the camera's buttons and displayed on the screen are also used in this guide when discussing relevant operations and functionality.

	☆ to the right of titles indicates functions only available in < Fv >, < P >, < Tv >, < Av >, < M >, or < B > mode or for manual exposure movie recording.
	Links to pages with related topics.
	Warning to prevent shooting problems.
	Supplemental information.
	Tips or advice for better shooting.
	Troubleshooting advice.

Basic Assumptions for Operational Instructions and Sample Photos

- Before following any instructions, make sure the power switch is set to < ON >  and the Multi-function lock feature is off .
- It is assumed that all the menu settings and Custom Functions are set to their defaults.
- Illustrations in this guide show the camera with the RF-S18-150mm F3.5-6.3 IS STM lens attached as an example.
- The sample photos displayed on the camera and used in this guide are for instructional purposes only.
- In instructions, it is assumed that you will select setting items with the <  > dial or <  >. Some items can also be selected by tapping the screen or using the <  > dial or <  > <  > <  > <  > keys.
- In references to using EF or EF-S lenses, it is assumed that a mount adapter is used.

Compatible Cards

The following cards can be used with the camera regardless of capacity. **If the card is new or was previously formatted (initialized) by another camera or computer, format the card with this camera** (🔗).

- **SD/SDHC/SDXC memory cards**

UHS-II and UHS-I cards compatible

Cards That Can Record Movies

When recording movies, use a card with ample performance (fast enough writing and reading speeds) for the movie recording size (🔗).



In this guide, "card" refers to SD memory cards, SDHC memory cards, and SDXC memory cards.

***A card is not included.** Please purchase it separately.

Safety Instructions

Be sure to read these instructions in order to operate the product safely.
Follow these instructions to prevent injury or harm to the operator of the product or others.

 **WARNING:** Denotes the risk of serious injury or death.

- Keep the product out of the reach of young children.

A strap wrapped around a person's neck may result in strangulation.

The parts or provided items of cameras or accessories are dangerous if swallowed. If swallowed, seek immediate medical assistance.

The battery is dangerous if swallowed. If swallowed, seek immediate medical assistance.

- **PRODUCT CONTAINS BUTTON/COIN CELL BATTERY**

Button/coin cell batteries are hazardous and must be kept out of reach of children at all times, whether new or used.

These batteries can cause severe or fatal injuries in 2 hours or less if swallowed or placed inside any part of the body.

If it is suspected a button/coin cell battery has been swallowed or placed inside any part of the body, seek medical attention immediately.

- Use only power sources specified in this instruction manual for use with the product.
- Do not disassemble or modify the product.
- Do not expose the product to strong shocks or vibration.
- Do not touch any exposed internal parts.
- Stop using the product in any case of unusual circumstances such as the presence of smoke or a strange smell.
- Do not use organic solvents such as alcohol, benzine or paint thinner to clean the product.
- Do not get the product wet. Do not insert foreign objects or liquids into the product.
- Do not use the product where flammable gases may be present.

This may cause electric shock, explosion or fire.

- Do not leave a lens or a camera/camcorder with a lens attached, exposed without the lens cap attached.

The lens may concentrate the light and cause fire.

- Do not touch the product connected to a power outlet during lightning storms.

This may cause electric shock.

- Observe the following instructions when using commercially available batteries or provided battery packs.
 - Use batteries/battery packs only with their specified product.
 - Do not heat batteries/battery packs or expose them to fire.
 - Do not charge batteries/battery packs using non-authorized battery chargers.
 - Do not expose the terminals to dirt or let them come into contact with metallic pins or other metal objects.
 - Do not use leaking batteries/battery packs.
 - When disposing of batteries/battery packs, insulate the terminals with tape or other means.

This may cause electric shock, explosion or fire.

If a battery/battery pack leaks and the material contacts your skin or clothing, flush the exposed area thoroughly with running water. In case of eye contact, flush thoroughly with copious amounts of clean running water and seek immediate medical assistance.

- Observe the following instructions when using a battery charger or AC adapter.
 - Periodically remove any dust buildup from the power plug and power outlet using a dry cloth.
 - Do not plug in or unplug the product with wet hands.
 - Do not use the product if the power plug is not fully inserted into the power outlet.
 - Do not expose the power plug and terminals to dirt or let them come into contact with metallic pins or other metal objects.
 - Do not touch the battery charger or AC adapter connected to a power outlet during lightning storms.
- Do not place heavy objects on the power cord. Do not damage, break or modify the power cord.
- Do not wrap the product in cloth or other materials when in use or shortly after use when the product is still warm in temperature.
- Do not unplug the product by pulling the power cord.
- Do not leave the product connected to a power source for long periods of time.
- Do not charge batteries/battery packs at temperatures outside the range of 5 - 40 °C (41 - 104 °F).

This may cause electric shock, explosion or fire.

- Do not allow the product to maintain contact with the same area of skin for extended periods of time during use.

This may result in low-temperature contact burns, including skin redness and blistering, even if the product does not feel hot. The use of a tripod or similar equipment is recommended when using the product in hot places and for people with circulation problems or less sensitive skin.

- Follow any indications to turn off the product in places where its use is forbidden.

Not doing so may cause other equipment to malfunction due to the effect of electromagnetic waves and even result in accidents.



CAUTION:

Follow the cautions below. Otherwise physical injury or property damage may result.

- Do not fire the flash near the eyes.

It may hurt the eyes.

- Do not look at the screen or through the viewfinder for prolonged periods of time.

This may induce symptoms similar to motion sickness. In such a case, stop using the product immediately and rest for a while before resuming use.

- Flash emits high temperatures when fired. Keep fingers, any other part of your body, and objects away from the flash unit while taking pictures.

This may cause burns or malfunction of the flash.

- Do not leave the product in places exposed to extremely high or low temperatures.

The product may become extremely hot/cold and cause burns or injury when touched.

- Strap is intended for use on the body only. Hanging the strap with any product attached on a hook or other object may damage the product. Also, do not shake the product or expose the product to strong impacts.

- Do not apply strong pressure on the lens or allow an object to hit it.

This may cause injury or damage to the product.

- Only mount the product on a tripod that is sufficiently sturdy.

- Do not carry the product when it is mounted on a tripod.

This may cause injury or may result in an accident.

- Do not touch any parts inside the product.

This may cause injury.

- If any abnormal skin reaction or irritation occurs during or following the use of this product, refrain from further use and get medical advice/attention.

- Do not leave batteries near pets.

Pets biting the battery pack could cause leakage, overheating, or explosion, resulting in product damage or fire.



Do not touch the screen storage compartment (A), because its temperature can increase by repeated continuous shooting for extended time or movie recording. This may cause burns.

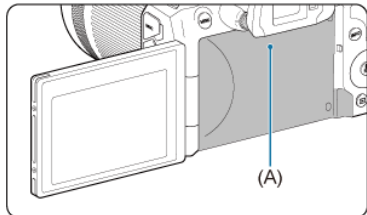

Handling Precautions

Camera care

- This camera is a precision instrument. Do not drop it or subject it to physical shock.
- The camera is not waterproof and cannot be used underwater.
- To maximize the camera's dust- and drip- resistance, keep the terminal cover, battery compartment cover, card slot cover, and all other covers firmly closed. Also attach the shoe cover to the multi-function shoe.
- This camera is designed to be dust- and drip- resistant, in order to help prevent sand, dust, dirt, or water that falls on it unexpectedly from getting inside, but it is impossible to prevent dirt, dust, water, or salt from getting inside at all. As far as possible, do not allow dirt, dust, water, or salt to get on the camera.
- If water gets on the camera, wipe it off with a dry and clean cloth. If dirt, dust, or salt gets on the camera, wipe it off with a clean, well-wrung wet cloth.
- Using the camera in dusty or dirty locations may lead to damage.
- Cleaning the camera after use is recommended. Allowing dirt, dust, water, or salt to remain on the camera may cause a malfunction.
- If you accidentally drop the camera into water or are concerned that moisture (water), dirt, dust, or salt may have gotten inside it, promptly consult the nearest Canon Service Center.
- Never leave the camera near anything having a strong magnetic field such as a magnet or electric motor. Also, avoid using or leaving the camera near anything emitting strong radio waves, such as a large antenna. Strong magnetic fields can cause camera malfunction or destroy image data.
- Do not leave the camera in excessive heat, such as in a car in direct sunlight. High temperatures can cause the camera to malfunction.
- The camera contains precision electronic circuitry. Never attempt to disassemble the camera yourself.
- Do not block shutter curtain operation with your finger or other objects. Doing so may cause a malfunction.
- Only use a commercially available blower to blow away dust on the lens, viewfinder, or other parts. Do not use cleaners that contain organic solvents to clean the camera body or lens. For stubborn dirt, take the camera to the nearest Canon Service Center.
- Do not touch the camera's electrical contacts with your fingers. This is to prevent the contacts from corroding. Corroded contacts can cause camera malfunction.
- If the camera is suddenly brought in from the cold into a warm room, condensation may form on the camera and internal parts. To prevent condensation, first put the camera in a sealed plastic bag and let it adjust to the warmer temperature before taking it out of the bag.
- If condensation forms on the camera, to avoid damage, do not use the camera or remove the lens, card, or battery. Turn the camera off and wait until the moisture has fully evaporated before resuming use. Even after the camera is completely dry, if it is still internally cold, do not remove the lens, card, or battery until the camera has adjusted to the ambient temperature.
- If the camera will not be used for an extended period, remove the battery and store the camera in a cool, dry, well-ventilated location. Even while the camera is in storage, press the shutter button a few times once in a while to check that the camera is still working.

- Avoid storing the camera where there are chemicals that result in rust and corrosion such as in a chemical lab.
- If the camera has not been used for an extended period, test all its functions before using it. If you have not used the camera for some time or if there is an important shoot such as a foreign trip coming up, have the camera checked by your nearest Canon Service Center or check the camera yourself and make sure it is working properly.
- The camera may become hot after repeated continuous shooting or still photo/movie shooting over an extended period. This is not a malfunction.
- If there is a bright light source inside or outside the image area, ghosting may occur.
- When shooting with backlighting, keep the sun sufficiently away from the angle of view. Always keep intense light sources such as the sun, lasers, and other intense artificial light sources out of the image area and not near it. Concentrated intense light may cause smoke or damage the image sensor or other internal components.
- Attach the lens cap to prevent direct sunlight and other light from entering the lens when you are not shooting.

Screen and viewfinder

The following does not affect images captured by the camera.

- Although the screen and viewfinder are manufactured with very high precision technology with over 99.99% effective pixels, 0.01% or fewer of the pixels may be dead, and there may also be spots of black, red, or other colors. This is not a malfunction.
- If the screen is left on for a prolonged period, screen burn-in may occur where you see remnants of what was displayed. However, this is only temporary and will disappear when the camera is left unused for a few days.
- The screen display may seem slightly slow in low temperatures or may look black in high temperatures. It will return to normal at room temperature.

Cards

To protect the card and its recorded data, note the following:

- Do not drop, bend, or wet the card. Do not subject it to excessive force, physical shock, or vibration.
- Do not touch the card's electronic contacts with your fingers or anything metallic.
- Do not affix any stickers, etc. on the card.
- Do not store or use the card near anything that has a strong magnetic field, such as a television, speakers, or magnets. Also avoid places prone to having static electricity.
- Do not leave the card in direct sunlight or near a heat source.
- Store the card in a case.
- Do not store the card in hot, dusty, or humid locations.
- Cards may become hot after long sessions of repeated continuous shooting or still photo shooting/movie recording. This is not a malfunction.

Lens

- After detaching the lens from the camera, put down the lens with the rear end up and attach the rear lens cap to avoid scratching the lens surface and electrical contacts (1).

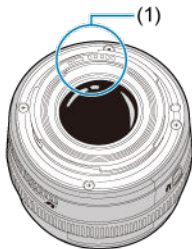

Smudges on the image sensor

Besides dust entering the camera from outside, in rare cases, lubricant from the camera's internal parts may adhere to the front of the sensor. If smudges are visible on images, have the sensor cleaned by a nearest Canon Service Center.

Battery



Tips for using the battery and charger

- Store in a cool, dry, well-ventilated location.
- When storing the battery for extended periods, charge it about once a year. When charging the battery, aim to charge it to approx. 50% instead of fully charging it (🔋).
- At room temperature (23°C/73°F), it takes approx. 60 min. to charge a depleted battery to about approx. 50%. Battery charging time varies greatly depending on ambient temperature.
- If the battery is not used for an extended period, the trace amount of current that continues to flow inside the battery when it is removed from the camera may eventually lead to over-discharge and prevent further use, even after charging.

Part Names

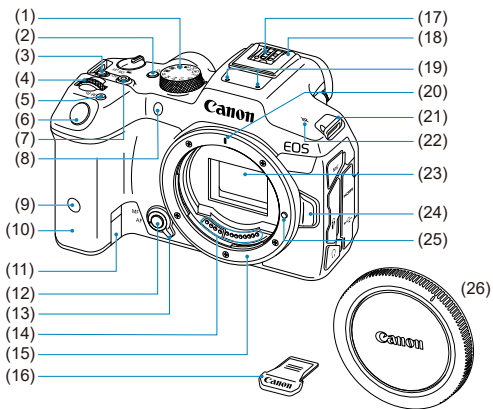
[Attaching the Strap](#)



-
- (1) Mode dial
 - (2) <LOCK> Multi-function lock button
 - (3) <ISO> ISO speed setting button
 - (4) < > Main dial
 - (5) <M-Fn> Multi-function button
 - (6) Shutter button
 - (7) Movie shooting button
 - (8) Self-timer lamp/AF-assist beam
 - (9) Remote control sensor
 - (10) Grip (battery compartment)
 - (11) DC cord hole
 - (12) Depth-of-field preview button
 - (13) Focus mode switch
 - (14) Contacts
 - (15) Lens mount
 - (16) Shoe cover
 - (17) Flash sync contacts
 - (18) Multi-function shoe
 - (19) Microphone
 - (20) RF lens mount index
 - (21) Strap mount
 - (22) < > Focal plane mark
 - (23) Image sensor
 - (24) Lens release button
 - (25) Lens lock pin
 - (26) Body cap
-

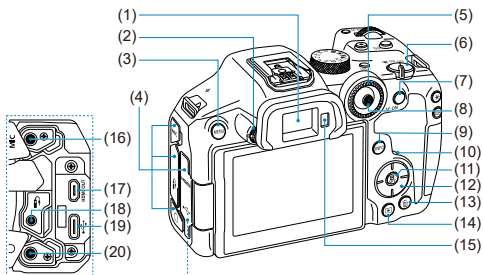

(1)	Viewfinder eyepiece
(2)	Dioptric adjustment knob
(3)	<MENU> Menu button
(4)	Terminal cover
(5)	<Q.C.D.> Quick control dial
(6)	<PWR / ON / OFF> Power switch
(7)	<AF-ON> AF start button
(8)	<M.C.> Multi-controller (can also be pressed straight in)
(9)	<INFO> Info button
(10)	Access lamp
(11)	<Q.C.S.> Quick Control/Set button
(12)	<CROSS KEYS> Cross keys
(13)	<ERASE> Erase button
(14)	<PLAYBACK> Playback button
(15)	Viewfinder sensor
(16)	<MIC> External microphone IN terminal
(17)	<HDMI OUT> HDMI micro OUT terminal
(18)	<RC> Remote control terminal
(19)	<DIGITAL> Digital terminal
(20)	<HP> Headphone terminal

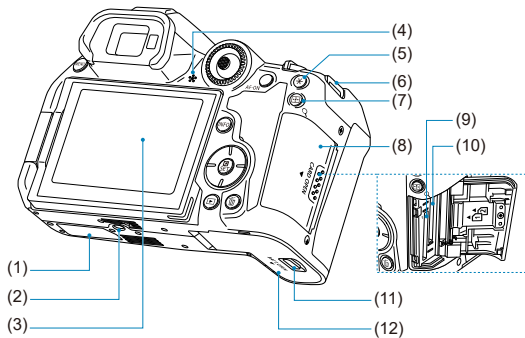

(1) Serial number (body number)

(2) Tripod socket

(3) Screen

(4) Speaker

(5) < * > AE lock button

(6) Strap mount

(7) < [AF] / Q > AF point selection/magnify/reduce button

(8) Card slot cover

(9) Card slot 1

(10) Card slot 2

(11) Battery compartment cover lock

(12) Battery compartment cover

Mode dial

The Mode dial is divided into Basic Zone and Creative Zone modes.

(1) Basic Zone

All you do is press the shutter button. The camera sets everything to suit the subject or scene for shooting.

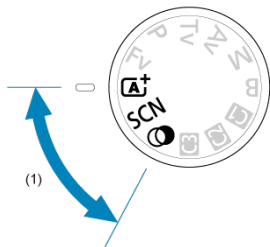

A⁺: Scene Intelligent Auto (🔒)

SCN: Special scene (🔒)

	Portrait		Close-up
	Group Photo		Food
	Landscape		Night Portrait
	Panoramic shot		Handheld Night Scene
	Sports		HDR Backlight Control
	Kids		Silent shutter
	Panning		

🌙: Creative filters (🔒)

	Grainy B/W		Miniature effect
	Soft focus		HDR art standard
	Fish-eye effect		HDR art vivid
	Water painting effect		HDR art bold
	Toy camera effect		HDR art embossed

(2) Creative Zone

These modes give you more control for shooting various subjects as desired.

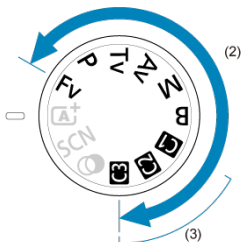

Fv	Flexible-priority AE
P	Program AE
Tv	Shutter-priority AE
Av	Aperture-priority AE
M	Manual exposure
B	Long (bulb) exposures

(3) Custom shooting modes

You can assign < **Fv** >, < **P** >, < **Tv** >, < **Av** >, < **M** >, < **B** >, AF operation, menu functions, and more to < **C1** >, < **C2** >, or < **C3** > (🔗).

Battery Charger LC-E6

Charger for Battery Pack LP-E6NH/LP-E6N/LP-E6 (🔗).

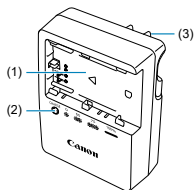

(1) Battery slots

(2) Charge lamp

(3) Power plug

Battery Charger LC-E6E

Charger for Battery Pack LP-E6NH/LP-E6N/LP-E6 (🔗).

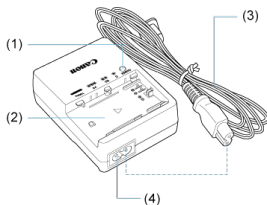

(1) Charge lamp

(2) Battery pack slot

(3) Power cord

(4) Power cord socket

Attaching the Strap

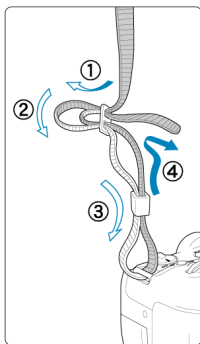

Pass the end of the strap through the strap mount from the bottom, then pass it through the strap buckle as shown. Pull the strap to take up any slack and make sure the strap will not loosen from the buckle.

Software

[!\[\]\(c8d96c8885d3000a912c2582004aed63_img.jpg\) Software Overview](#)

[!\[\]\(919a2cb85b99741a73c0c31a427236a8_img.jpg\) Downloading and Installing EOS Software or Other Dedicated Software](#)

[!\[\]\(666e09182d4cd268646ea700ea60dcdf_img.jpg\) Software Instruction Manuals](#)

Software Overview

This section summarizes software used with EOS cameras. Note that downloading and installing the software requires an internet connection. The software cannot be downloaded or installed in environments without an internet connection.

EOS Utility

Enables you to transfer your captured still photos and movies from the camera to a connected computer, set various camera settings from the computer, and shoot remotely from the computer.

Digital Photo Professional

Software recommended for users who shoot RAW images. Enables image viewing, editing, printing, and more.

Picture Style Editor

Enables you to edit existing Picture Styles or create and save original Picture Style files. This software is for users who are familiar with image processing.

Downloading and Installing EOS Software or Other Dedicated Software

Always install the latest version of the software.

Update any previous versions that are installed by overwriting them with the latest version.

Caution

- Do not connect the camera to a computer before you install the software. The software will not be installed correctly.
- The software cannot be installed unless the computer is connected to the internet.
- Previous versions cannot display images from this camera correctly. Also, processing RAW images from this camera is not possible.

1. Download the software.

- Connect to the internet from a computer and access the following Canon website.

<https://cam.start.canon/>



- Select your country or region of residence and download the software.
- Depending on the software, you may need to enter the camera's serial number. The serial number is on the bottom of the camera.
- Decompress it on the computer.

- **For Windows**

Click the displayed installer file to start the installer.

- **For macOS**

A dmg file will be created and displayed. Follow the steps below to startup the installer.

1. Double-click the dmg file.

- A drive icon and installer file will appear on the desktop. If the installer file does not appear, double-click the drive icon to display it.

2. Double-click the installer file.

- The installer starts.

2. Follow the on-screen instructions to install the software.

Check the following website for software instruction manuals.

- <https://cam.start.canon/>



Preparation and Basic Operations

This chapter describes preparatory steps before you start shooting and the basic camera operations.

- [Charging the Battery](#)
- [Inserting/Removing Batteries](#)
- [Inserting/Removing Cards](#)
- [Using the Screen](#)
- [Turning on the Power](#)
- [Attaching and Detaching RF/RF-S Lenses](#)
- [Attaching and Detaching EF/EF-S Lenses](#)
- [Multi-Function Shoe](#)
- [Using the Viewfinder](#)
- [Basic Operations](#)
- [Menu Operations and Settings](#)
- [Quick Control](#)
- [Touch-Screen Operation](#)

Charging the Battery

1. Detach the protective cover provided with the battery.

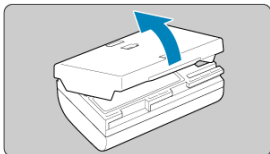

2. Fully insert the battery into the charger.

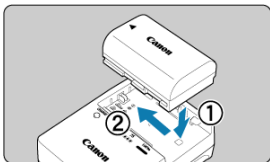

- Do the opposite to remove the battery.

3. Recharge the battery. For LC-E6

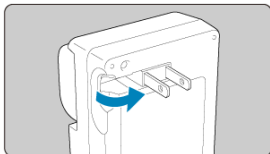

- As shown by the arrow, flip out the battery charger's prongs and insert the prongs into a power outlet.

For LC-E6E

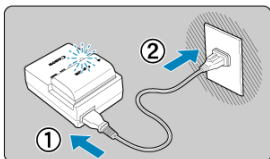

- Connect the power cord to the charger and insert the plug into a power outlet.
- Recharging starts automatically and the charge lamp blinks in orange.

Charge Level	Charge Lamp	
	Color	Display
0–49%	Orange	Blinks once per second
50–74%		Blinks twice per second
75% or higher		Blinks three times per second
Fully charged	Green	Turned on

- **Charging a depleted battery takes approx. 3 hr. at room temperature (23°C/73°F).** The time required to charge the battery will vary greatly depending on the ambient temperature and the battery's remaining capacity.
- For safety, charging in low temperatures (5–10°C/41–50°F) takes longer (up to approx. 4 hr.).

- **Upon purchase, the battery is not fully charged.**
Charge the battery before use.
- **Charge the battery on the day before or on the day it is to be used.**
Charged batteries gradually lose their charge, even when they are not used.
- **After charging the battery, remove it and disconnect the charger from the power outlet.**
- **You can attach the protective cover in a different orientation to indicate whether the battery is charged or not.**

If the battery is charged, attach the provided protective cover so that the battery-shaped hole <  > is aligned over the blue sticker on the battery. If the battery is exhausted, attach the protective cover in the opposite orientation.



- **When not using the camera, remove the battery.**
If the battery is left in the camera for a prolonged period, a small amount of power current will keep being released, resulting in excess discharge and shorter battery life. Store the battery with the protective cover attached. Storing the battery when it is fully charged may lower the battery performance.
- **The battery charger can also be used in foreign countries.**
The battery charger is compatible with a 100 V AC to 240 V AC 50/60 Hz power source. If necessary, attach a commercially available plug adapter for the respective country or region. To avoid damage, do not connect to portable voltage transformers.
- **If the battery becomes exhausted quickly even after having been fully charged, the battery has reached the end of its service life.**
Check the battery's recharge performance () and purchase a new battery.

Caution

- After disconnecting the charger's power plug, do not touch the prongs for approx. 10 sec.
- If the battery's remaining capacity () is 94% or higher, the battery will not be charged.
- The provided charger cannot charge any battery other than Battery Pack LP-E6NH/LP-E6N/LP-E6.

Inserting/Removing Batteries

 [Insertion](#)

 [Removal](#)

Insert a fully charged Battery Pack LP-E6NH (or LP-E6N/LP-E6) in the camera.

Insertion

1. Slide the battery compartment cover lock and open the cover.

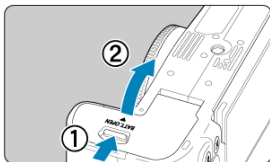

2. Insert the battery.

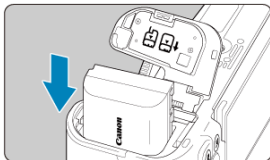

- Insert the end with the electrical contacts.
- Insert the battery until it locks in place.

3. Close the cover.

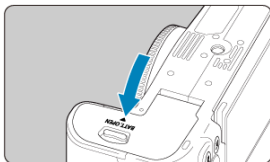

- Press the cover until it snaps shut.

Caution

- You cannot use batteries other than Battery Pack LP-E6NH/LP-E6N/LP-E6.

1. Open the cover and remove the battery.

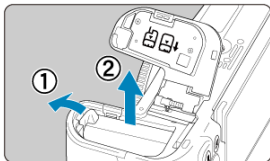

- Press the battery lock lever as shown by the arrow and remove the battery.
- To prevent short-circuits, always attach the included protective cover (🔒) to the battery.

Inserting/Removing Cards

[✔ Insertion](#)

[✔ Formatting the Card](#)

[✔ Removal](#)

This camera accepts two cards. **Recording is possible as long as there is at least one card in the camera.**

With two cards inserted, you can select one card to record to, or you can record the same image to both cards at once (✔).

⚠ Caution

- **Make sure the card's write-protect switch (1) is set upward to enable writing and erasing.**

Insertion

1. Slide the cover to open it.

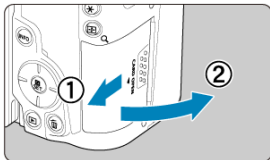

2. Insert the card.

Card 1

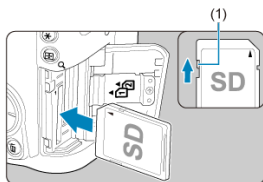

Card 2

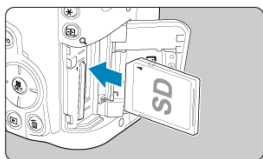

- The card in the rear card slot is [1], and the one in front of it is [2].
- As shown by the illustration, face the card's label side toward you and insert it until it clicks in place.

3. Close the cover.

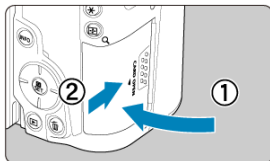

- Close the cover and slide it in the direction shown by the arrows until it snaps shut.

4. Set the power switch to <ON> (☑).

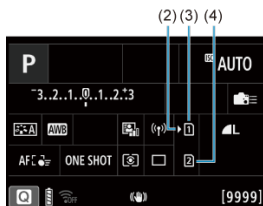
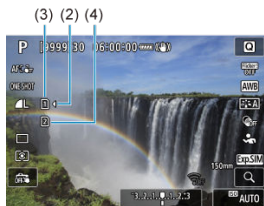

- (2) Card selection icon
- (3) Card 1
- (4) Card 2

- Icons representing loaded cards are shown on the shooting screen (☑) accessed by pressing the <INFO> button and on the Quick Control screen (☑). **Cards labeled with [] are selected for recording.**

Formatting the Card

If the card is new or was previously formatted (initialized) by another camera or computer, format the card with this camera (🔗).

1. Open the cover.

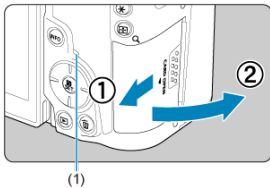

- Set the power switch to < OFF >.
- Check that the access lamp (1) is off, then open the cover.
- If [Saving...] is displayed on the screen, close the cover.

2. Remove the card.

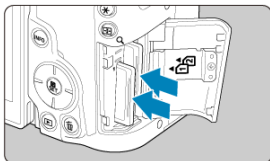

- Gently push in the card, then let it go to eject.
- Pull the card straight out, then close the cover.

Caution

Do not remove cards immediately after a red [🔥] icon is displayed as you are shooting. Cards may be hot, due to high internal camera temperature. Set the power switch to < OFF > and stop shooting for a while before removing cards. Removing hot cards immediately after shooting may cause you to drop and damage them. Be careful when removing cards.

Note

- The number of shots available varies depending on remaining card capacity and settings such as image quality and ISO speed.
- Setting [📷: **Release shutter without card**] to [Disable] will prevent you from forgetting to insert a card (🔗).

Caution

- **When the access lamp is lit or blinking, it indicates that images are being written to, read from, or erased from the card, or data is being transferred. Do not open the card slot cover during this time. To avoid corrupting image data or damaging cards or the camera, never do any of the following while the access lamp is lit or blinking.**
 - Removing the card.
 - Removing the battery.
 - Shaking or striking the camera.
 - **Unplugging or plugging in a power cord**
(when using optional household power outlet accessories).
- If the card already contains recorded images, the image number may not start from 0001 (🔗).
- If a card-related error message is displayed on the screen, remove and reinsert the card. If the error persists, use a different card.
If you can transfer images on the card to a computer, transfer all the images and then format the card with the camera (🔗). The card may then return to normal.
- Do not touch the card's contacts with your fingers or metal objects. Do not expose the contacts to dust or water. If smudges adhere to the contacts, contact failure may result.
- Multimedia cards (MMC) cannot be used. (Card error will be displayed.)
- Use of UHS-II microSDHC/SDXC cards with a microSD to SD adapter is not recommended.
When using UHS-II cards, use SDHC/SDXC cards.

Using the Screen

You can change the direction and angle of the screen.

1. Flip out the screen.

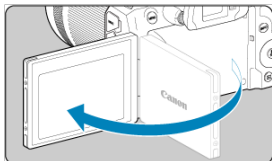

2. Rotate the screen.

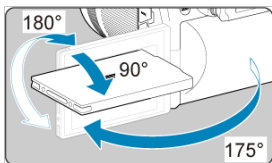

- When the screen is out, you can tilt it up or down or rotate it to face the subject.
- Indicated angles are only approximate.

3. Face it toward you.

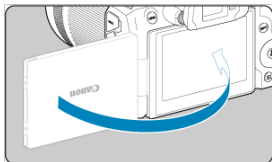

- Normally, use the camera with the screen facing you.

 **Caution**

- Avoid forcing the screen into position as you rotate it, which puts undue pressure on the hinge.
- When a cable is connected to a camera terminal, the rotation angle range of the flipped-out screen will be limited.

 **Note**

- Keep the screen closed and facing the camera body when the camera is not in use. You can protect the screen.
- A mirror image (right/left reversed) of subjects is displayed when the screen faces subjects in front of the camera.

Turning on the Power

 [Setting the Date, Time, and Time Zone](#)

 [Changing the Interface Language](#)

 [Automatic Sensor Cleaning](#)

 [Battery Level Indicator](#)

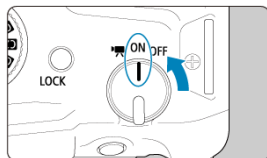

●  >

The camera turns on. This mode is for movie recording.

● <ON>

The camera turns on. This mode is for still photo shooting.

● <OFF>

The camera is turned off and does not function. Set the power switch to this position when not using the camera.

Note

- If you set the power switch to <OFF> while an image is being recorded to the card, [Saving...] will be displayed and the power will turn off after the recording finishes.





Setting the Date, Time, and Time Zone

If you turn on the camera and the date/time/zone setting screen appears, see [Date/Time/Zone](#) to set the date/time/zone.

Changing the Interface Language

To change the interface language, see [Language](#).

Automatic Sensor Cleaning

- Whenever the power switch is set to < **OFF** >, the sensor is cleaned automatically (which may make a faint sound). During the sensor cleaning, the screen will display []. To enable automatic sensor cleaning when the power switch is set to < **ON** > as well, you can set this in [: **Sensor cleaning**] ().
- If you repeatedly turn the power switch to < **ON** > or < **OFF** > within a short time period, the [] icon may not be displayed, but this does not indicate the camera is malfunctioning.

Battery Level Indicator

The battery indicator shows the remaining capacity when the camera is on.



Display						
Level (%)	100-70	69-50	49-20	19-10	9-1	0

Note

- Doing any of the following will exhaust the battery faster:
 - Pressing the shutter button halfway for a prolonged period.
 - Activating the AF frequently without taking a picture.
 - Using Image Stabilizer.
 - Using the Wi-Fi function or Bluetooth function.
 - Using the screen frequently.
- The number of available shots may decrease depending on the actual shooting conditions.
- Lens operations are powered by the camera's battery. Certain lenses may exhaust the battery faster than others.
- See [: **Battery info.**] to check the battery status ().
- In low ambient temperatures, shooting may not be possible even with a sufficient battery level.

Attaching and Detaching RF/RF-S Lenses

 [Attaching a Lens](#)

 [Detaching a Lens](#)

Caution

- Do not look at the sun directly through any lens. Doing so may cause loss of vision.
- When attaching or detaching a lens, set the camera's power switch to < **OFF** >.
- If the front part (focusing ring) of the lens rotates during autofocusing, do not touch the rotating part.

Tips for avoiding smudges and dust

- When changing lenses, do it quickly in a place with minimal dust.
- When storing the camera without a lens attached, be sure to attach the body cap to the camera.
- Remove smudges and dust on the body cap before attaching it.

Attaching a Lens

1. Remove the caps.

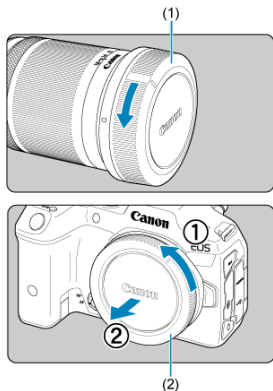

- Remove the rear lens cap (1) and body cap (2) by turning them as shown by the arrows.

2. Attach the lens.

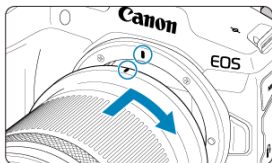



- Align the red mount index on the lens with the red mount index on the camera and turn the lens as shown by the arrow until it clicks in place.



3. Set the focus mode to (< AF >).

- < AF > stands for autofocus.
- < MF > stands for manual focus. Autofocus is disabled.

● For RF lenses without a focus mode switch

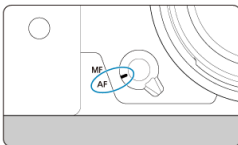
- With [ : **AF/MF**] set to [Enable] (), set the focus mode switch on the front of the camera to < AF >.



- With [ : **AF/MF**] set to [Disable] (), set [**AF**: Focus mode] to [AF].

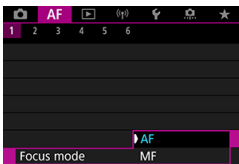

- **For RF lenses with a focus mode switch**

Set the lens's focus mode switch to < AF >. The setting on the lens takes precedence, and the camera's focus mode switch and [Fn: ] switch (AF/MF) setting have no effect.

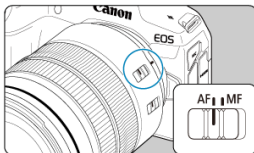

4. Remove the front lens cap.

Detaching a Lens

While pressing the lens release button, turn the lens as shown by the arrow.

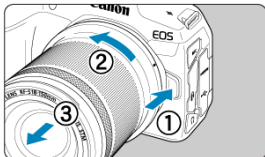

- Turn the lens until it stops, then detach it.
- Attach the rear lens cap to the lens you removed.

Attaching and Detaching EF/EF-S Lenses

[Attaching a Lens](#)

[Detaching a Lens](#)

All EF and EF-S lenses can be used by attaching an optional Mount Adapter EF-EOS R.
The camera cannot be used with EF-M lenses.

Attaching a Lens

1. Remove the caps.

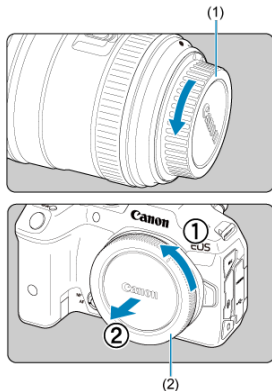

- Remove the rear lens cap (1) and body cap (2) by turning them as shown by the arrows.

2. Attach the lens to the adapter.

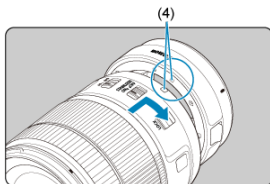
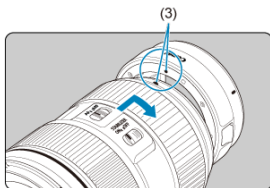

- Align the red or white mount index on the lens with the corresponding mount index on the adapter and turn the lens as shown by the arrow until it clicks into place.

(3) Red index

(4) White index

3. Attach the adapter to the camera.

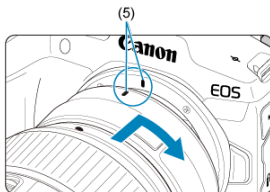

- Align the red mount indexes (5) on the adapter and camera and turn the lens as shown by the arrow until it clicks into place.

4. Set the lens's focus mode switch to <AF>.

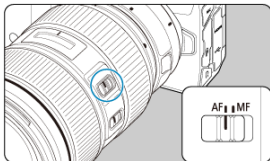

- <AF> stands for autofocus.
- <MF> stands for manual focus. Autofocus will not operate.

5. Remove the front lens cap.

Detaching a Lens

1. While pressing the lens release button, turn the adapter as shown by the arrow.

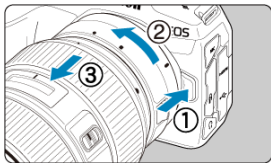

- Turn the lens until it stops, then detach it.

2. Detach the lens from the adapter.

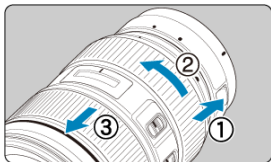

- Hold down the lens release lever on the adapter and turn the lens counterclockwise.
- Turn the lens until it stops, then detach it.
- Attach the rear lens cap to the lens you removed.

Caution

- For lens precautions, see [Attaching and Detaching RF/RF-S Lenses](#).

Multi-Function Shoe

[Using the Multi-Function Shoe](#)

The multi-function shoe is a hot shoe that supplies power to accessories and offers advanced communication functionality.

Using the Multi-Function Shoe

Removing the shoe cover

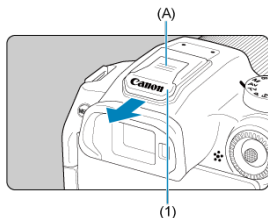

- Remove the shoe cover (1) by pressing the part labeled (A) in the figure as shown with your finger. After removal, keep the shoe cover in a convenient place to avoid losing it.

Attaching accessories

- When attaching accessories that communicate through contacts of the multi-function shoe, insert the accessory's mounting foot until it clicks into place, then slide the mounting foot locking lever to secure it. For details, refer to the accessory's Instruction Manual.
- The following accessories cannot be attached directly to the multi-function shoe.
 - Speedlite EL-1/600EXII-RT/600EX-RT/580EX II
 - Speedlite Transmitter ST-E3-RT (Ver. 2)/ST-E3-RT
 - Off-Camera Shoe Cord OC-E3
 - GPS Receiver GP-E2
- To use the accessories listed above with the camera, you will need Multi-Function Shoe Adapter AD-E1, sold separately. For details, refer to the AD-E1 Instruction Manual.
- When attaching accessories other than these that are designed for regular hot shoes, insert the accessory's mounting foot all the way in, then slide the mounting foot locking lever to secure it. For details, refer to the accessory's Instruction Manual.
- Electronic Viewfinder EVF-DC2/EVF-DC1 cannot be attached to the multi-function shoe. Attempting to attach the accessories by force may damage them or the multi-function shoe.

Attaching the shoe cover

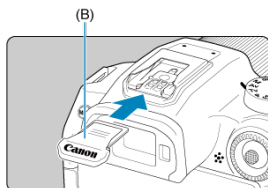

- After removing accessories from the multi-function shoe, reattach the shoe cover to protect the contacts from dust and water.
- Slide the shoe cover all the way in by pressing the part labeled (B) in the figure, as shown.

Caution

- Attach accessories correctly as described in [Attaching accessories](#). Incorrect attachment may cause the camera or accessories to malfunction, and accessories may fall off.
- Blow off any foreign material on the multi-function shoe with a commercially available blower or similar tool.
- If the multi-function shoe becomes wet, turn off the camera and allow it to dry before use.
- Use the shoe cover included with the camera.

Using the Viewfinder

[Dioptric Adjustment](#)

Look through the viewfinder to activate it. You can also restrict display to either the screen or viewfinder ().

Dioptric Adjustment

1. Turn the dioptric adjustment knob.

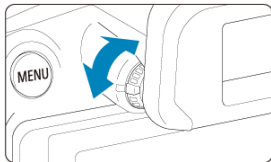

- Turn the knob left or right to make the viewfinder display look sharp.

Caution

- The viewfinder and screen cannot be activated at the same time.
- Viewfinder display is disabled when the screen is flipped out, even if you look through the viewfinder.
- At some aspect ratios, black bars are displayed on the top and bottom or left and right edges of the screen. These areas are not recorded.

Basic Operations

- [Holding the Camera](#)
- [Shutter Button](#)
- [☰ > Main Dial](#)
- [☉ > Quick Control Dial](#)
- [☼ > Multi-Controller](#)
- [≤ M-Fn ≥ Multi-Function Button](#)
- [≤ AF-ON > AF Start Button](#)
- [≤ LOCK > Multi-Function Lock Button](#)
- [≤ ☉ > Control Ring](#)
- [≤ INFO > Info Button](#)

Holding the Camera

● Viewing the screen as you shoot

As you shoot, you can tilt the screen to adjust it. For details, see [Using the Screen](#).



- (1) Normal angle
- (2) Low angle
- (3) High angle

● Shooting through the viewfinder

To obtain sharp images, hold the camera still to minimize camera shake.

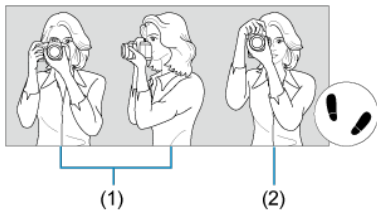

- (1) Horizontal shooting
- (2) Vertical shooting

1. With your right hand, hold the camera firmly by the camera grip.
2. With your left hand, support the lens from below.
3. Rest your right index finger lightly on the shutter button.
4. Rest your arms and elbows lightly against the front of your body.
5. To maintain a stable stance, place one foot slightly ahead of the other.
6. Hold the camera near your face and look through the viewfinder.

Shutter Button

The shutter button has two steps. You can press the shutter button halfway. Then you can further press the shutter button completely.

Pressing halfway

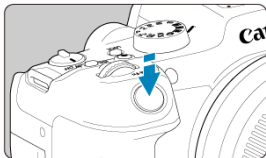

This activates autofocus and the automatic exposure system that sets the shutter speed and aperture value.

The exposure value (shutter speed and aperture value) is displayed on the screen or in the viewfinder for 8 sec. (metering timer/8).

Pressing completely

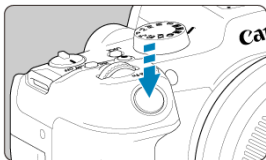

This releases the shutter and takes the picture.

● Preventing camera shake

Hand-held camera movement during the moment of exposure is called camera shake. It can cause blurred pictures. To prevent camera shake, note the following:

- Hold the camera still, as shown in [Holding the Camera](#).
- Press the shutter button halfway to autofocus, then slowly press the shutter button completely.



Note

- The camera will still pause before taking a picture if you press the shutter button completely without pressing it halfway first, or if you press the shutter button halfway and immediately press it completely.
- Even during menu display or image playback, you can return to shooting standby by pressing the shutter button halfway.

(1) After pressing a button, turn the <  > dial.

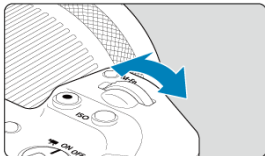
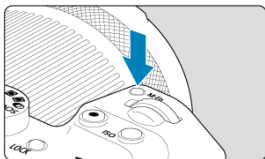

Press a button such as < M-Fn > or < ISO >, then turn the <  > dial.

If you press the shutter button halfway, the camera will go back to shooting standby.

- Used for operations such as setting the ISO speed, drive mode, AF operation, white balance, and flash exposure compensation.

(2) Turn only the <  > dial.

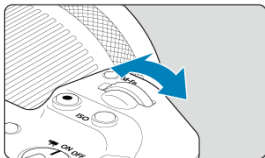

While looking at the screen or viewfinder, turn the <  > dial.

- Use this dial to set the shutter speed, aperture value, etc.

 **Note**

- The operations in (1) can be performed even when controls are locked with the Multi-function lock () .

< > Quick Control Dial

(1) After pressing a button, turn the <  > dial.

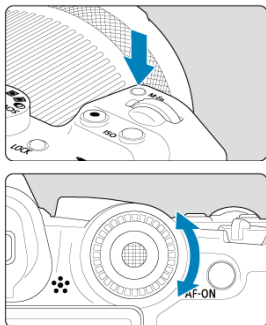



Press a button such as < M-Fn > or < ISO >, then turn the <  > dial.

If you press the shutter button halfway, the camera will go back to shooting standby.

- Used for operations such as selecting the ISO speed, drive mode, AF operation, white balance, and flash exposure compensation.

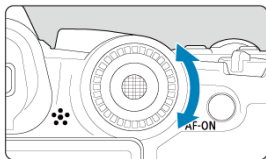
(2) Turn only the <  > dial.



While looking at the screen or viewfinder, turn the <  > dial.

- Used for operations such as setting the exposure compensation amount and the aperture value setting for manual exposures.

Note

- The operations in (1) can be performed even when controls are locked with the Multi-function lock ().

< * > Multi-Controller

< * > is an eight-direction key with center button. To use it, press lightly with the tip of your thumb.

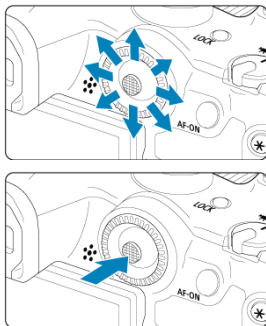

- Examples of using the Multi-controller
 - AF point/magnified frame movement in still photo shooting or movie recording
 - White balance correction
 - Magnified area position movement during playback
 - Quick Control
 - Selecting or setting menu items

<M-Fn> Multi-Function Button

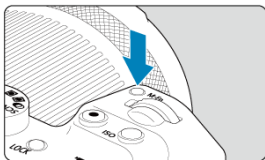

By pressing the <M-Fn> button and turning the <☀> dial, you can set the ISO speed (☑), drive mode (☑), AF operation (☑), white balance (☑), and flash exposure compensation (☑).

To select the AF area, press the <☐☐☐> button, then press the <M-Fn> button (☑6).

< AF-ON > AF Start Button

Equivalent to pressing the shutter button halfway (in Creative Zone modes).

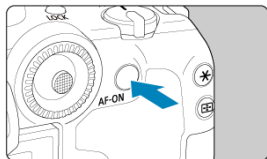

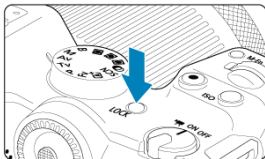

<LOCK> Multi-Function Lock Button

Configuring [**F**: **Multi function lock**] () and pressing the <LOCK> button prevents settings from being changed by accidentally touching the Main dial, Quick control dial, Multi-controller, control ring, or touch-screen panel. Press the <LOCK> button again to unlock the controls.

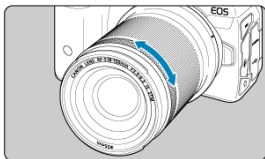

< > Control Ring



By default, exposure compensation can be set by turning the control ring of RF lenses or mount adapters while pressing the shutter button halfway in < **Fv** >, < **P** >, < **Tv** >, < **Av** >, or < **M** > mode. Otherwise, you can assign a different function to the control ring by customizing operations in [: **Customize dials**] ().

<INFO> Info Button

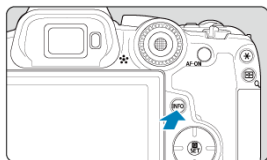

Each press of the <INFO> button changes the information shown. The following sample screens are for still photos.



(1)

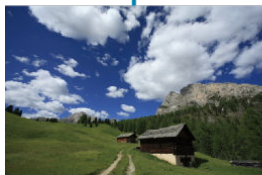





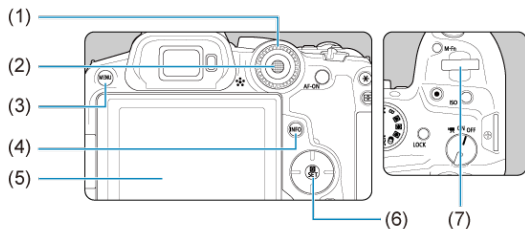

* In Basic Zone modes, the screen by (1) is not displayed.

Menu Operations and Settings

- [Basic Zone Menu Screen](#)
- [Creative Zone Menu Screen](#)
- [Menu Setting Procedure](#)
- [Dimmed Menu Items](#)



-
- (1) <  > Quick control dial
-
- (2) <  > Multi-controller
-
- (3) <  > MENU > button
-
- (4) <  > INFO > button
-
- (5) Screen
-
- (6) <  > button
-
- (7) <  > Main dial
-

Basic Zone Menu Screen

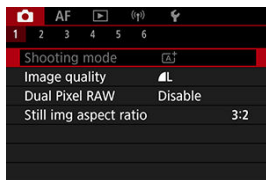

* In Basic Zone modes, some tabs and menu items are not displayed.

Creative Zone Menu Screen

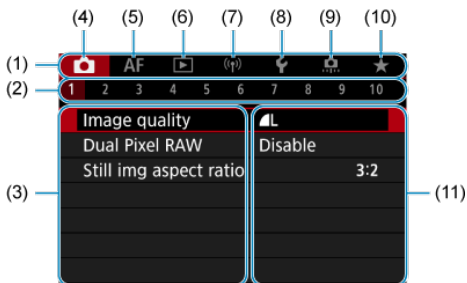

-
- (1) Main tabs
 - (2) Secondary tabs
 - (3) Menu items
 - (4) : Shooting
 - (5) **AF**: Autofocus
 - (6) : Playback
 - (7) : Wireless features
 - (8) : Set-up
 - (9) : Custom Functions
 - (10) : My Menu
 - (11) Menu settings
-

1. Display the menu screen.

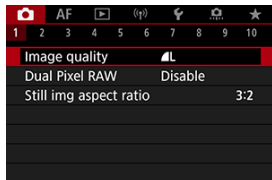



- Press the < MENU > button to display the menu screen.

2. Select a tab.

- Press the < INFO > button to switch between main tabs (groups of functions).
- Turn the <  > dial to select a secondary tab.

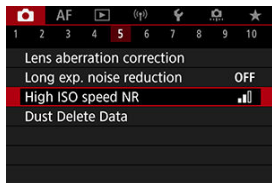
3. Select an item.



- Turn the <  > dial to select an item, then press the <  > button.

4. Select an option.

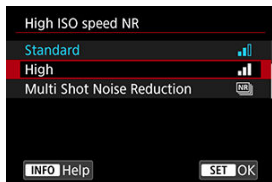

- Turn the <  > dial to select an option.
- The current setting is indicated in blue.

5. Set an option.

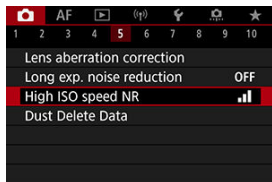



- Press the <  > button to set it.

6. Exit the setting.

- Press the < MENU > button to return to shooting standby.

Note

- The description of menu functions hereafter assumes that you have pressed the < MENU > button to display the menu screen.
- Menu operations are also possible by tapping the menu screen or using <  > or <  >.
- To cancel the operation, press the < MENU > button.

Dimmed Menu Items

Example: When set to single shooting drive mode

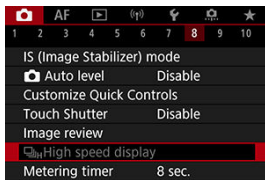

Dimmed menu items cannot be set. The menu item is dimmed if another function setting is overriding it.



You can see the overriding function by selecting the dimmed menu item and pressing the < (P) > button.

If you cancel the overriding function's setting, the dimmed menu item will become settable.

Caution

- You may not be able to see the overriding function for certain dimmed menu items.

Note

- You can reset menu functions to the default settings by selecting **[Basic settings]** in [**Reset camera**] (🔗).

Quick Control

You can directly and intuitively select and set the settings displayed.

1. Press the <  > button (⌘10).

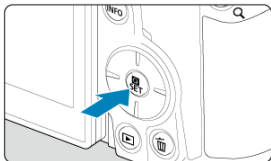

Touch-Screen Operation

☑ [Tapping](#)

☑ [Dragging](#)

Tapping

Sample screen (Quick Control)



- Use your finger to tap (touch briefly and then remove your finger from) the screen.
- For example, when you tap [Q], the Quick Control screen appears. By tapping [↶], you can return to the preceding screen.

Note

- To have the camera beep for touch operations, set [🔊: Beep] to [Enable] (🔊).
- Responsiveness to touch operations can be adjusted in [🔊: Touch control] (🔊).

Dragging

Sample screen (Menu screen)



- Slide your finger while touching the screen.

Basic Zone

This chapter describes how to use the Basic Zone modes on the Mode dial for best results. With Basic Zone modes, all you do is point and shoot, and the camera sets everything automatically.

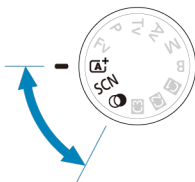
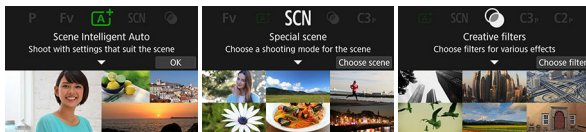

- [A+: Fully Automatic Shooting \(Scene Intelligent Auto\)](#)
- [Special Scene Mode](#)
 - [Portrait Mode](#)
 - [Group Photo Mode](#)
 - [Landscape Mode](#)
 - [Panoramic Shot Mode](#)
 - [Sports Mode](#)
 - [Kids Mode](#)
 - [Panning Mode](#)
 - [Close-up Mode](#)
 - [Food Mode](#)
 - [Night Portrait Mode](#)
 - [Handheld Night Scene Mode](#)
 - [HDR Backlight Control Mode](#)
 - [Silent Shutter Mode](#)
- [Creative Filters Mode](#)

A+: Fully Automatic Shooting (Scene Intelligent Auto)

- [Shooting Moving Subjects](#)
- [Scene Icons](#)
- [Adjusting Settings](#)
- [Shooting with Effects Applied \(Creative Assist\)](#)

< **A+** > is a fully automatic mode. The camera analyzes the scene and sets the optimum settings automatically. It can also adjust focus automatically on either the still or moving subject by detecting the motion of the subject (👁).

1. Set the Mode dial to < **A+** >.

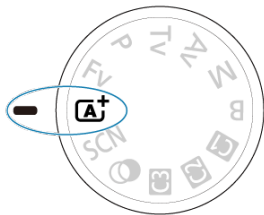

2. Press the < **OK** > button.

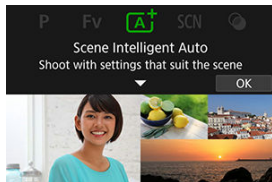

- Read the message and select **[OK]**.

3. Aim the camera at what you will shoot (the subject).

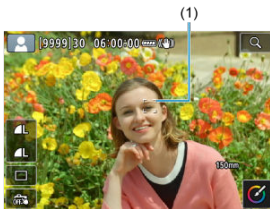

- An AF point (1) may be displayed on the subject, under some shooting conditions.
- When an AF point is displayed on the screen, aim it over the subject.

4. Focus on the subject.

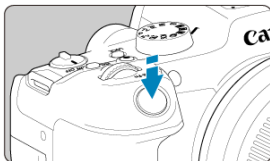

- Press the shutter button halfway to focus.
- You can also focus by tapping a person's face or other subject on the screen (Touch AF).
- Under low light, the AF-assist beam (☑) is automatically activated if needed.
- Once the subject is in focus, that AF point turns green and the camera beeps (One-Shot AF).
- An AF point in focus on a moving subject turns blue and tracks subject movement (Servo AF).

5. Take the picture.

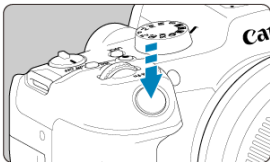

- Press the shutter button completely to take the picture.
- The image just captured will be displayed for approx. 2 sec. on the screen.

⚠ Caution

- Subject movement (whether subjects are still or moving) may not be detected correctly for some subject or shooting conditions.

📄 Note

- AF operation (One-Shot AF or Servo AF) is set automatically when you press the shutter button halfway. Even when automatically set to One-Shot AF, the camera will switch to Servo AF if subject motion is detected while you are pressing the shutter button halfway.
- The < **A+** > mode makes the colors look more impressive in nature, outdoor, and sunset scenes. If you do not obtain the desired color tones, change the mode to a Creative Zone mode (📷) and select a Picture Style other than [S-A], then shoot again (📷).

💡 Minimizing blurred photos

- Be careful about camera shake in handheld shots. To avoid camera shake, consider using a tripod. Use a sturdy tripod that can bear the weight of the shooting equipment. Attach the camera securely to the tripod.
- Consider using a remote switch (sold separately, 📷) or wireless remote control (sold separately, 📷).

? FAQ

- **Focusing is not possible (indicated by an orange AF point).**
Aim the AF point over an area with good contrast, then press the shutter button halfway (Ⓔ). If you are too close to the subject, move away and shoot again.
- **Multiple AF points are displayed simultaneously.**
Focus has been achieved at all those points.
- **The shutter speed display is blinking.**
Since it is too dark, taking the picture may result in a blurred subject due to camera shake. Using a tripod or a Canon EL/EX series Speedlite (sold separately, Ⓔ) is recommended.
- **The bottom of pictures taken with flash is unnaturally dark.**
If a hood is attached to the lens, it may obstruct light from the flash. If the subject is close, detach the hood before taking the picture with flash.



Note

- Note the following if you are not using flash.
 - Under low light, when camera shake tends to occur, hold the camera steady or use a tripod. When using a zoom lens, you can reduce the blur caused by camera shake by setting the lens to the wide-angle end.
 - When shooting portraits under low light, tell subjects to stay still until you have finished shooting. Any movement as you shoot will make the person look blurry in the picture.

Shooting Moving Subjects



Pressing the shutter button halfway tracks moving subjects to keep them in focus. Keep the subject on the screen as you hold down the shutter button halfway, and at the decisive moment, press the shutter button completely.

Scene Icons



The camera detects the scene type and sets everything automatically to suit the scene. In still photo shooting, an icon representing the detected scene appears in the upper left of the screen (📷).

Adjusting Settings



By touching icons on the screen, you can adjust settings for drive mode, image quality, Touch Shutter, and Creative Assist.

Shooting with Effects Applied (Creative Assist)

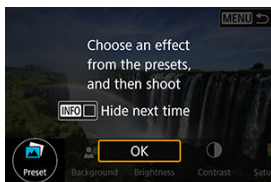
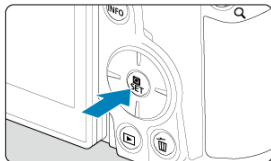

1. Press the  button.



- Read the message and select [OK].

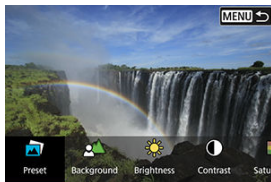

2. Select an effect.





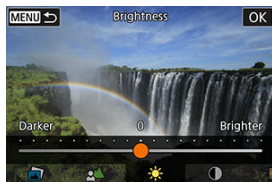





- Use the  dial to select an effect, then press the  button.

3. Select the effect level and other details.



- Set with the <  > dial, then press the <  > button.
- To reset the setting, press the <  > button, then select [OK].

Creative Assist effects

-  **Preset**
Select one of the preset effects.
Note that **[Saturation]**, **[Color tone 1]**, and **[Color tone 2]** are not available with **[B&W]**.
-  **Background blur**
Adjust background blur. Choose higher values to make backgrounds sharper. To blur the background, choose lower values. **[Auto]** adjusts background blurring to match the brightness. Depending on lens brightness (f/number), some positions may not be available.
-  **Brightness**
Adjust image brightness.
-  **Contrast**
Adjust contrast.
-  **Saturation**
Adjust the vividness of colors.
-  **Color tone 1**
Adjust amber/blue color tone.
-  **Color tone 2**
Adjust green/magenta color tone.
-  **Monochrome**
Set the toning effect for monochrome shooting.

Note

- **[Background blur]** is not available in flash photography.
- These settings are reset when you switch shooting modes or set the power switch to **< OFF >**. To save the settings, set : **Retain Creative Assist data** to **[Enable]**.

Saving effects

To save the current setting to the camera, tap **[INFO]**  **Register** on the **[Creative Assist]** setting screen, then select **[OK]**. Up to three presets can be saved as **[USER*]**. After three have been saved, an existing **[USER*]** preset must be overwritten to save a new one.

Special Scene Mode

The camera will automatically choose the appropriate settings when you select a shooting mode for your subject or scene.

* < **SCN** > stands for Special Scene.

1. Set the Mode dial to < **SCN** >.

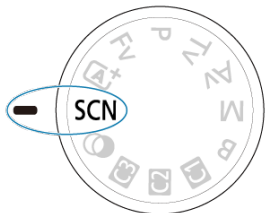

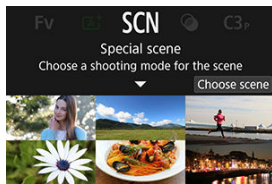

2. Press the <  > button.



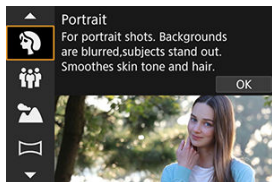

3. Select a shooting mode.





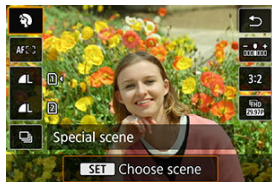

- Use the <  > dial to select a shooting mode, then press the <  > button.

4. Review the settings.















- Press the <  > button to display the Quick Control screen.

Note

- You can also set the shooting mode in [: Shooting mode].
- When [: Mode guide] is set to [Disable], after step 1, press the <  > button to access the Quick Control screen, use the <  > dial to select a shooting mode, then press the <  > button.

Available Shooting Modes in <SCN> Mode

Shooting Mode			
	Portrait		Close-up
	Group Photo		Food
	Landscape		Night Portrait
	Panoramic shot		Handheld Night Scene
	Sports		HDR Backlight Control
	Kids		Silent shutter
	Panning		

Portrait Mode

Use [P] (Portrait) mode to blur the background and make the person you shoot stand out. It also makes skin tones and hair look softer.

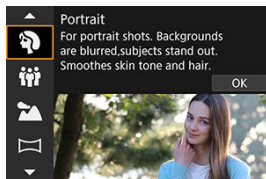

Shooting tips

- **Select the location where the distance between the subject and the background is the farthest.**

The further the distance between the subject and background, the more blurred the background will look. The subject will also stand out better against an uncluttered dark background.

- **Use a telephoto lens.**

If you have a zoom lens, use the telephoto end to fill the frame with the subject from the waist up.

- **Focus on the face.**

As you focus before shooting, make sure the AF point on the subject's face is green. When shooting close-ups of faces, you can set [AF: Eye detection] to [Enable] to shoot with the subject's eyes in focus.

- **Shoot continuously.**

The default setting is [C] (Low speed continuous). If you keep holding down the shutter button, you can shoot continuously to capture changes in the subject's facial expression and pose.

Group Photo Mode

Use [👥] (Group Photo) mode to take group photos. You can shoot with people from the front to the back all in focus.

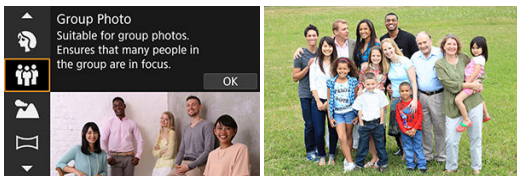

💡 Shooting tips

- **Use a wide-angle lens.**

With zoom lenses, zooming out near the wide-angle end makes it easier to focus on everyone in front and back at once. You can also increase the depth of field by standing a little farther away from subjects, so that they fit completely in the frame.

- **Take a few shots of the group.**

It is a good idea to take a few shots, because people sometimes blink.

📷 Note

- Hold the camera steady or use a tripod when shooting indoors or under low light.

⚠ Caution

- The angle of view changes slightly, due to distortion correction.
- Not all people may be in focus, depending on shooting conditions.

Landscape Mode

Use [🏞️] (Landscape) mode for expansive scenery, to keep everything in focus from near to far. For vivid blues and greens, and sharp and crisp images.

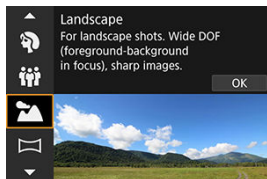

💡 Shooting tips

- **With a zoom lens, use the wide-angle end.**

When using a zoom lens, set the lens to the wide-angle end to make the objects near and far in focus. It also adds breadth to landscapes.

- **Keep the camera steady when shooting night scenes.**

Using a tripod is recommended.

⚠️ Caution

- Flash photography is not available.

Panoramic Shot Mode

Use [📷] (Panoramic Shot) mode to shoot panoramas. The panorama is created by combining shots captured in continuous shooting as you move the camera in one direction while pressing the shutter button completely.

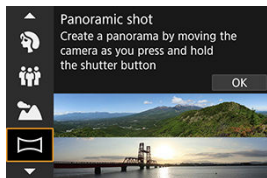

1. Choose a shooting direction.



- Press the < [📷] > button or tap [📷↔️] in the lower right to choose the direction you will shoot.
- An arrow is displayed showing the direction to move the camera.

2. Press the shutter button halfway.

- Keeping the shutter button pressed halfway, focus on the subject.

3. Shoot.

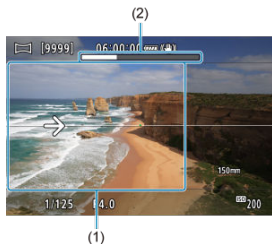

- Press the shutter button completely and move the camera at a constant speed in the direction of the arrow.
- The area displayed clearly (1) is captured.
- A shooting progress indicator (2) is displayed.
- Shooting stops when you release the shutter button, or when all of the progress indicator is white.

Caution

- In some scenes, images you intended to capture may not be saved as expected, and the panorama may not look as expected.
- Shooting may stop midway if you move the camera too slowly or quickly. However, the panorama created up to that point will still be saved.
- In consideration of the large sizes of mode images, use a computer or other device to resize panorama images if you will print them from a memory card inserted in a Canon printer.
If panoramas cannot be managed correctly by software or Web services, try resizing them on a computer.
- Shots of the following subjects and scenes may not be combined correctly.
 - Subjects in motion
 - Subjects at close range
 - Scenes where the contrast varies greatly
 - Scenes with long stretches of the same color or pattern, such as the sea or sky
- Shooting is not affected by any correction applied to counteract blur from swinging the camera.
- Move the camera slowly when using a lens with a long focal length, or when shooting night scenes or under low light.
- Lens image stabilization is not applied.

Sports Mode

Use [Fn] (Sports) mode to shoot subjects in motion, such as runners or moving vehicles.

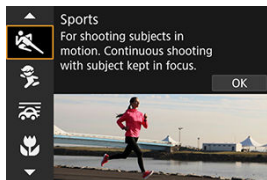

Shooting tips

- **Use a telephoto lens.**

Use of a telephoto lens is recommended to enable shooting from a distance.

- **Track the subject with the Area AF frame.**

An Area AF frame appears after you press the shutter button halfway. Once the subject is in focus, the AF point turns blue.

- **Shoot continuously.**

The default setting is [Fn] (High speed continuous). At the decisive moment, press the shutter button completely to take the picture. To track the subject and capture changes as it moves, keep holding down the shutter button to shoot continuously.

Caution

- Under low light where camera shake tends to occur, the shutter speed value in the lower left will blink. Hold the camera steady and shoot.
- Flash photography is not available.

Kids Mode

Use [] (Kids) mode to capture active children who are moving around. Skin tones will look vibrant.

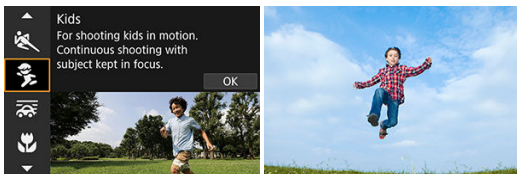

Shooting tips

- **Track the subject with the Area AF frame.**

By default, [**AF**: AF area] is set to [**Whole area AF**]. Area AF frames (1) appear when you press the shutter button halfway. Once the subject is in focus, the AF point turns blue.

- **Shoot continuously.**

The default setting is [] (High speed continuous). At the decisive moment, press the shutter button completely to take the picture. To track the subject and capture changes in facial expression and movement, keep holding down the shutter button to shoot continuously.

Caution

- Using an external flash unit will reduce the continuous shooting speed.

Panning Mode

By panning, you can blur the background to convey a sense of speed.

Attach a lens compatible with  (Panning) mode to reduce subject blurring and keep subjects clear and sharp.

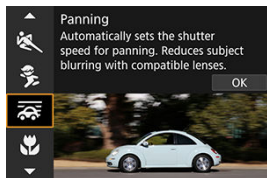

Shooting tips







- **Turn the camera to follow the moving subject.**

As you shoot, turn the camera smoothly while tracking the moving subject. With the AF point over the part of the moving subject to focus on, press the shutter button halfway, start turning the camera to keep up with the subject, then press the shutter button completely to shoot. Continue tracking the subject with the camera after this.

- **Set the level of background motion blur.**

In [Effect], you can set the level of background motion blur. Set to [Effect: max] for a slower shutter speed and more background motion blur around subjects. If subject blur is excessive, reduce it by setting [Effect] to [Effect: med] or [Effect: min].

Caution

- For details on lenses compatible with  mode, visit the Canon website .
- Shutter speeds are slower. For this reason, Panning mode is not suitable unless you pan as you shoot.
- AF area options are limited to **[1-point AF]**, **[Flexible Zone AF 1]**, **[Flexible Zone AF 2]**, and **[Flexible Zone AF 3]**.
- The default setting is . Note that H is not available.
- Flash photography is not available.
- Although lens IS is applied to images captured with lenses supporting  mode, the effect is not shown on the screen as you shoot. (IS and subject blur correction are activated when you shoot, regardless of the lens IS setting.)
- With lenses that do not support  mode, subject blur is not reduced, but shutter speed is automatically adjusted to match the **[Effect]** setting.
- Your specified panning effect level may not be applied when shooting under bright light (such as on sunny summer days), or when shooting slow subjects.
- The following subjects or shooting conditions may prevent suitable subject blur correction with lenses supporting  mode.
 - Subjects with very low contrast.
 - Subjects in low light.
 - Strongly backlit or reflective subjects.
 - Subjects with repetitive patterns.
 - Subjects with few patterns, or with monotone patterns.
 - Subjects with reflections (such as images reflected in glass).
 - Subjects smaller than the Zone AF frame.
 - Multiple subjects moving within a Zone AF frame.
 - Subjects moving in irregular directions or at irregular speeds.
 - Subjects that sometimes move erratically (such as runners who move up and down as they run).
 - Subjects with significant changes in speed (such as immediately after initial movement, or when moving along a curve).
 - When the camera moves too quickly or slowly.
 - When camera movement does not match subject movement.
 - With long lens focal lengths.

Close-up Mode

Use [🌸] (Close-up) mode for close-ups of small subjects such as flowers. To make small things appear much larger, use a macro lens (sold separately).



Shooting tips

- **Use a simple background.**
A simple background makes small objects such as flowers stand out better.
- **Move in as close as possible to the subject.**
Check the lens for its minimum focusing distance. The lens minimum focusing distance is measured from the \ominus (focal plane) mark on the top of the camera to the subject. Focusing is not possible if you are too close.
- **With a zoom lens, use the telephoto end.**
If you have a zoom lens, using the telephoto end will make the subject look larger.

Food Mode

Use **[F]** (Food) mode for culinary photography. The photo will look bright and appetizing. Also, the reddish tinge due to the light source will be suppressed in the pictures taken under tungsten lights, etc.

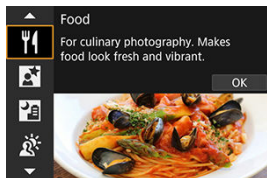

Shooting tips

- **Change the color tone.**

[Color tone] can be adjusted. To increase the reddish tinge of food, set toward **[Warm tone]** (red), or set toward **[Cool tone]** (blue) if it looks too red.

Caution

- The warm color cast of subjects may fade.
- When multiple light sources are included in the scene, the warm color cast of the picture may not be reduced.
- In flash photography, **[Color tone]** switches to the standard setting.
- If there are people in the picture, the skin tone may not be reproduced properly.

Night Portrait Mode

Use **[P]** (Night Portrait) mode for bright, beautiful shots of people with night scenes in the background. Note that shooting in this mode **requires an external flash unit**. Using a tripod is recommended.

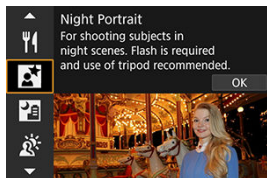

Shooting tips

● **Use a wide-angle lens and a tripod.**

When using a zoom lens, use the wide-angle end to obtain a wide night view. Because camera shake occurs in handheld shooting, using a tripod is also recommended.



● **Check the image brightness.**

It is recommended to play back the captured image on location to check the image brightness. If the subject looks dark, move nearer and shoot again.

● **Also shoot in other shooting modes.**

Consider also shooting in **< A+ >** and **[P]** mode, because shots are more likely to be blurry.

Caution

- Tell subjects to remain still for a moment after the flash fires.
- Focusing may be difficult if subject faces look dark when you shoot. In this case, set the focus mode to MF () and focus manually.
- Autofocusing at night or in dark scenes may be difficult when points of light lie within the AF point. In this case, set the focus mode to MF () and focus manually.
- Shots will look slightly different from the preview image shown on the screen.

Note

- The self-timer lamp fires briefly after shots in this mode if the self-timer is used.

Handheld Night Scene Mode

 (Handheld Night Scene) mode enables handheld shooting for night scenes. In this shooting mode, four shots are taken consecutively for each picture, and the resulting image with reduced camera shake is recorded.

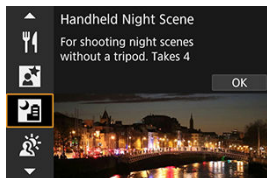

Shooting tips

● Hold the camera steady.

Keep your elbows close to your body to hold the camera steady (). In this mode, four shots are aligned and merged into a single image, but if there is significant misalignment in any of the four shots due to camera shake, they may not align properly in the final image.

Caution

- Compared to other shooting modes, the image area will be smaller.
- RAW image quality cannot be set.
- Flash photography is not available.
- Autofocusing at night or in dark scenes may be difficult when points of light lie within the AF point. In this case, set the focus mode to MF () and focus manually.
- Shooting moving subjects may result in afterimages from the movement, or darkness around the subject.
- The image alignment may not function properly with repetitive patterns (lattice, stripes, etc.), flat or single-tone images, or images significantly misaligned due to camera shake.
- It takes some time to record images to the card since they are merged after shooting. "BUSY" appears on the screen as images are processed, and shooting is not possible until processing is finished.
- Shots will look slightly different from the preview image shown on the screen.

HDR Backlight Control Mode

Use [HDR] (HDR Backlight Control) mode for backlit scenes with both bright and dark areas. Shooting once in this mode captures three consecutive images at different exposures, which are combined to create a single HDR image that retains detail in shadows that might otherwise be lost from backlighting.

* HDR stands for High Dynamic Range.

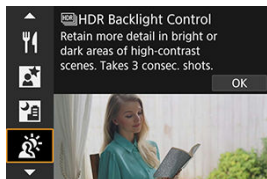

Shooting tips

● Hold the camera steady.

Keep your elbows close to your body to hold the camera steady (📵). In this mode, three shots are aligned and merged into a single image. However, if there is significant misalignment in any of the three shots due to camera shake, they may not align properly in the final image.

⚠ Caution

- Compared to other shooting modes, the image area will be smaller.
- RAW image quality cannot be set.
- Flash photography is not available.
- Note that the image may not be rendered with a smooth gradation and may look irregular or have significant noise.
- HDR Backlight Control may not be effective for excessively backlit scenes or extremely high-contrast scenes.
- When shooting subjects that are sufficiently bright as they are, for example for normally lit scenes, the image may look unnatural due to the HDR effect.
- Shooting moving subjects may result in afterimages from the movement, or darkness around the subject.
- The image alignment may not function properly with repetitive patterns (lattice, stripes, etc.), flat or single-tone images, or images significantly misaligned due to camera shake.
- It takes some time to record images to the card since they are merged after shooting. "BUSY" appears on the screen as images are processed, and shooting is not possible until processing is finished.

Silent Shutter Mode

Where silence is needed, you can shoot without beeps or shutter release sounds.

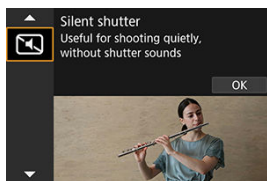

Shooting tips

- **Take some test shots.**

Consider taking some test shots in advance, because lens aperture and focusing adjustment may be audible under some shooting conditions.

Caution

- Be responsible when using silent shooting, and respect subject privacy and portrait rights.
- Images of fast-moving subjects may look distorted.
- Continuous shooting and flash photography are not available.

Creative Filters Mode

[Creative Filter Characteristics](#)

[Adjusting the Miniature Effect](#)

You can shoot with filter effects applied. Filter effects can be previewed before you shoot.

1. Set the Mode dial to .

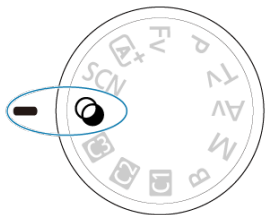

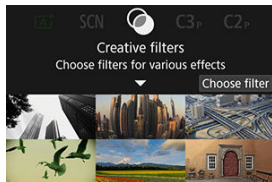

2. Press the  button.



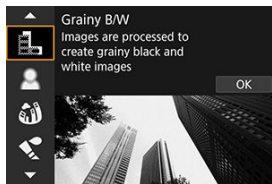





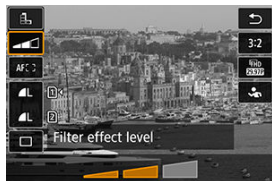

3. Select a filter effect.











- Turn the <  > dial to select a filter effect () , then press the <  > button.
- The image is shown with the filter effect applied.

4. Adjust the effect and shoot.



- Press the <  > button and select an icon below **[Creative filters]** (except , , , , or ).
- Turn the <  > dial to adjust the effect, then press the <  > button.

Caution











- These operations are also possible by using <  > or <  >.
- RAW and RAW+JPEG are not available. When RAW image quality is set, images are captured with  image quality. When RAW+JPEG image quality is set, images are captured with the specified JPEG image quality.
- Continuous shooting is not available when , , , , , or  is set.



Note

- With [**Grainy B/W**], the grainy preview will differ somewhat from the appearance of your shots.
- With [**Soft focus**] or [**Miniature effect**] options, the blurred effect preview may differ somewhat from the appearance of your shots.
- No histogram is displayed.
- A magnified view is not available.
- In Creative Zone modes, some Creative filter settings are available from the Quick Control screen (🔍).





Creative Filter Characteristics

-  **Grainy B/W**
Makes the image grainy and black and white. By adjusting the contrast, you can change the black-and-white effect.
-  **Soft focus**
Gives the image a soft look. By adjusting the blur, you can change the degree of softness.
-  **Fish-eye effect**
Gives the effect of a fish-eye lens. The image will have barrel distortion. Depending on the level of this filter effect, the area trimmed along the periphery of the image changes. Also, because this filter effect magnifies the center of the image, the apparent resolution at the center may degrade depending on the number of recorded pixels, so set the filter effect while checking the resulting image. One AF point is used, fixed at the center.
-  **Water painting effect**
Makes the photo look like a watercolor painting with soft colors. By adjusting the effect, you can change the color density. Note that night scenes or dark scenes may not be rendered with a smooth gradation and may look irregular or have significant noise.
-  **Toy camera effect**
Shifts colors to those typical of toy cameras and darkens the four corners of the image. Color tone options can be used to change the color cast.
-  **Miniature effect**
Creates a diorama effect.
Shooting under the default setting will keep the center looking sharp.
To move the area that looks sharp (the scene frame), see [Adjusting the Miniature Effect](#). [1-point AF] is used as the AF area. Shooting with the AF point and scene frame aligned is recommended.
-  **HDR art standard**
Photos retain more detail in highlights and shadows. With reduced contrast and flatter gradation, the finish resembles a painting. The subject outlines will have bright (or dark) edges.
-  **HDR art vivid**
Colors are more saturated than with  **HDR art standard**, and the low contrast and flat gradation resemble graphic art.
-  **HDR art bold**
The colors are the most saturated, making the subject pop out, and the picture looks like an oil painting.

●  **HDR art embossed**









The color saturation, brightness, contrast and gradation are decreased to make the picture look flat, so that the picture looks faded and old. The subject outlines will have intensely bright (or dark) edges.

 **Caution**

Precautions for , , , and 









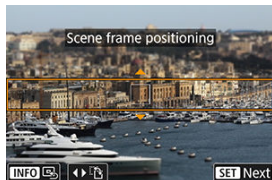





- Compared to other shooting modes, the image area will be smaller.
- Shots will look slightly different from the filter effect previews shown on the screen.
- Shooting moving subjects may result in afterimages from the movement, or darkness around the subject.
- The image alignment may not function properly with repetitive patterns (lattice, stripes, etc.), flat or single-tone images, or images significantly misaligned due to camera shake.
- Be careful about camera shake in handheld shots.
- Subjects such as the sky or white walls may not be rendered with smooth gradation and may have noise or irregular exposure or colors.
- Shooting under fluorescent or LED lighting may result in unnatural color reproduction of the illuminated areas.
- It takes some time to record images to the card since they are merged after shooting. **BUSY** appears on the screen as images are processed, and shooting is not possible until processing is finished.
- Flash photography is not available.

 **Note**

- With , , , and , you can shoot high dynamic range photos that retain detail in highlights and shadows of high-contrast scenes. Three consecutive images are captured at different brightnesses each time you shoot and used to create a single image. See the precautions for , , , and .

1. Move the scene frame.



- Use the scene frame to set an area that will look sharp.
- To make the scene frame movable (displayed in orange), press the <  > button or tap  in the lower right of the screen. By tapping , you can also switch between vertical and horizontal scene frame orientation. Switching scene frame orientation is also possible with the <  > <  > keys when in horizontal orientation and <  > <  > keys when in vertical orientation.
- To move the scene frame, use the <  > dial or <  > <  > <  > <  > keys. To center the scene frame again, press the < INFO > button.
- To return to positioning the AF point, press the <  > button again.
- To confirm the position of the scene frame, press the <  > button.

2. Move the AF point as needed and shoot.





- The AF point turns orange and can be moved.
- Press the < ▲ > < ▼ > < ◀ > < ▶ > keys to move the AF point to the position to focus on.
- Aligning the AF point and scene frame is recommended.
- To return the AF point to the center of the screen, tap [⏏].
- To confirm the position of the AF point, press the < (SET) > button.

Creative Zone

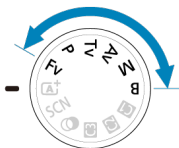
Creative Zone modes give you the freedom to shoot in a variety of ways by setting your preferred shutter speed, aperture value, exposure, and more.



- To clear the shooting mode description displayed when you turn the Mode dial, press the <  > button ().
- [Fv: Flexible-Priority AE](#)
- [P: Program AE](#)
- [Tv: Shutter-Priority AE](#)
- [Av: Aperture-Priority AE](#)
- [M: Manual Exposure](#)
- [B: Long \(Bulb\) Exposures](#)

Fv: Flexible-Priority AE

In this mode, you can set shutter speed, aperture value, and ISO speed manually or automatically and combine these settings with your choice of exposure compensation. Shooting in <Fv> mode, with control over each of these parameters, is equivalent to shooting in <P>, <Tv>, <Av>, or <M> mode.

* <Fv> stands for Flexible value.

1. Set the Mode dial to <Fv>.

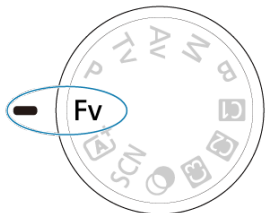

2. Set the shutter speed, aperture value, and ISO speed.



- Turn the <☀> dial to select an item to set. [☀] appears to the left of the selected item.
- Turn the <☀> dial to set the option.
- To reset the setting to [AUTO], press the <🗑> button.

3. Set the amount of exposure compensation.



- Turn the dial and select the exposure level indicator. appears to the left of the exposure level indicator.
- Turn the dial to set the option.
- To reset the setting to $[\pm 0]$, press the button.

Combinations of functions in < Fv > mode

Shutter Speed	Aperture Value	ISO Speed	Exposure Compensation	Shooting Mode
[AUTO]	[AUTO]	[AUTO] Manual selection	Available	Similar to < P >
Manual selection	[AUTO]	[AUTO] Manual selection	Available	Similar to < Tv >
[AUTO]	Manual selection	[AUTO] Manual selection	Available	Similar to < Av >
Manual selection	Manual selection	[AUTO] Manual selection	Available -	Similar to < M >

Caution

- Blinking of the values indicates a risk of underexposure or overexposure. Adjust the exposure until the value stops blinking.
- Slow synchro is not used under low light when you have set up < Fv > mode to resemble < Av > or < P > mode, even when [Slow synchro] in : External Speedlite control] is set to [1/320-30 sec. auto] (or [1/250-30sec. auto]).



Note

- Values for shutter speed, aperture value, and ISO speed that are set to **AUTO** are underlined.
- You can set shutter speed, aperture value, and ISO speed to **AUTO** and exposure compensation amount to **±0** in step 2 or 3 by holding down the <  > button.

P: Program AE

The camera automatically sets the shutter speed and aperture value to suit the subject's brightness.

* <P> stands for Program.

* AE stands for Auto Exposure.

1. Set the Mode dial to <P>.

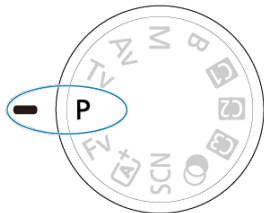

2. Focus on the subject.

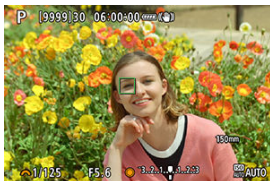

- Aim the AF point over the subject and press the shutter button halfway.
- Once the subject is in focus, the AF point turns green (with One-Shot AF).
- The shutter speed and aperture value are set automatically.

3. Check the display.



- As long as the exposure value is not blinking, standard exposure will be obtained.

4. Take the picture.

- Compose the shot and press the shutter button completely.

Caution



- If the "30" shutter speed and the lowest aperture value blink, it indicates underexposure. Increase the ISO speed or use flash.



- If the "1/8000" shutter speed and the highest aperture value blink, it indicates overexposure. Lower the ISO speed or use an ND filter (sold separately) to reduce the amount of light entering the lens.

Note

Differences between <P> and <A+> modes

- <A+> mode limits available functions and sets the AF area, metering mode, and many other functions automatically to prevent bad shots. In contrast, <P> mode only sets the shutter speed and aperture value automatically, and you can freely set the AF area, metering mode, and other functions.

Program shift

- In <P> mode, you can freely change the combination (program) of shutter speed and aperture value set automatically by the camera while maintaining the same exposure. This is called Program shift.
- With Program shift, you can press the shutter button halfway, then turn the <PROGRAM> dial until the desired shutter speed or aperture value is displayed.
- Program shift will be canceled automatically when the metering timer ends (exposure setting display turns off).
- Program shift cannot be used with flash.

Tv: Shutter-Priority AE

In this mode, you set the shutter speed and the camera automatically sets the aperture value to obtain the standard exposure matching the brightness of the subject. A faster shutter speed can freeze the action of a moving subject. A slower shutter speed can create a blurred effect, giving the impression of motion.

* < **Tv** > stands for Time value.



Blurred motion
(Slow speed: 1/30 sec.)



Frozen motion
(Fast speed: 1/2000 sec.)

-
1. Set the Mode dial to < **Tv** >.

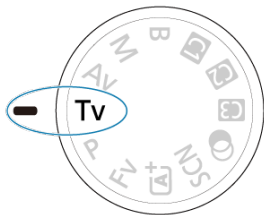

2. Set the desired shutter speed.



- Turn the <  > dial to set it.

3. Focus on the subject.

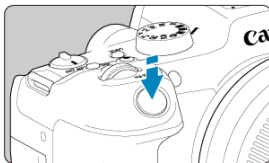

- Press the shutter button halfway.
- The aperture value is set automatically.

4. Check the display and shoot.



- As long as the aperture value is not blinking, the standard exposure will be obtained.

Caution



- If the lowest aperture value blinks, it indicates underexposure.
Turn the <  > dial to set a slower shutter speed until the aperture value stops blinking or set a higher ISO speed.



- If the highest aperture value blinks, it indicates overexposure.
Turn the <  > dial to set a faster shutter speed until the aperture value stops blinking, or set a lower ISO speed.

 **Note**

Shutter speed display

- For example, "0"5" indicates 0.5 sec. and "15"", 15 sec.

Av: Aperture-Priority AE

[Depth-of-Field Preview](#)

In this mode, you set the desired aperture value and the camera sets the shutter speed automatically to obtain the standard exposure matching the subject brightness. A higher f/number (smaller aperture hole) will make more of the foreground and background fall within acceptable focus. On the other hand, a lower f/number (larger aperture hole) will make less of the foreground and background fall within acceptable focus.

* < **Av** > stands for Aperture value (aperture opening).



Blurred background
(With a low aperture value: f/5.6)

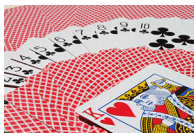

Sharp foreground and background
(With a high aperture value: f/32)

-
1. Set the Mode dial to < **Av** >.

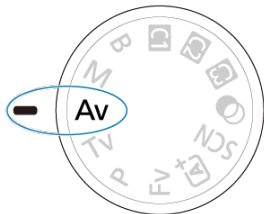

2. Set the desired aperture value.



- Turn the <  > dial to set it.

3. Focus on the subject.

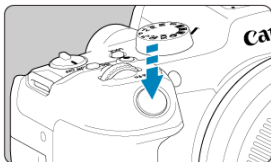

- Press the shutter button halfway.
- The shutter speed is set automatically.

4. Check the display and shoot.



- As long as the shutter speed is not blinking, the standard exposure will be obtained.

Caution



- If the "30'" shutter speed blinks, it indicates underexposure. Turn the <  > dial to decrease the aperture value (open the aperture) until the shutter speed blinking stops or set a higher ISO speed.



- If the "1/8000" shutter speed blinks, it indicates overexposure. Turn the <  > dial to increase aperture value (close the aperture) until the shutter speed blinking stops or set a lower ISO speed.



Note

Aperture value display

- The higher the value, the smaller the aperture opening will be. The aperture value displayed varies depending on the lens. If no lens is attached to the camera, **"F00"** will be displayed for the aperture.

Depth-of-Field Preview

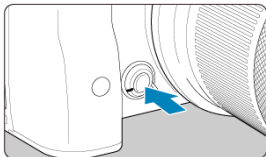

Press the depth-of-field preview button to stop down the lens to the current aperture value setting and check the area in focus (depth of field).

Note

- The larger the aperture value, the wider the area in focus, from the foreground to the background.
- The depth-of-field effect is readily apparent on images as you change the aperture value and press the depth-of-field preview button.
- Exposure is locked (AE lock) as you hold down the depth-of-field preview button.

M: Manual Exposure

[Exposure Compensation with ISO Auto](#)

In this mode, you set both the shutter speed and aperture value as desired. To determine the exposure, refer to the exposure level indicator or use a commercially available exposure meter.

* <M> stands for Manual.

1. Set the Mode dial to <M>.

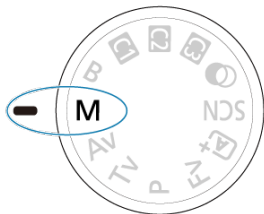



2. Set the ISO speed .

- Press the <ISO> button to set it.
- With ISO Auto, you can set exposure compensation .

3. Set the shutter speed and aperture value.



- To set the shutter speed, turn the < > dial, and to set the aperture value, turn the < > dial.

4. Focus on the subject.



- Press the shutter button halfway.
- Check the exposure level mark [] to see how far the current exposure level is from the standard exposure level.

(1) Standard exposure index

(2) Exposure level mark

5. Set the exposure and take the picture.



- Check the exposure level indicator and set the desired shutter speed and aperture value.

Exposure Compensation with ISO Auto









If the ISO speed is set to **[AUTO]** for manual exposure shooting, you can set exposure compensation (⊖) as follows:

- Tap the exposure level indicator
- : **Expo.comp./AEB**
- Turn the control ring while pressing the shutter button halfway

Caution

- Exposure may not be as expected when ISO Auto is set, because the ISO speed is adjusted to ensure standard exposure for your specified shutter speed and aperture value. In this case, set the exposure compensation.
- Exposure compensation is not applied in flash photography with ISO Auto, even if you have set an exposure compensation amount.

 **Note**

- ISO speed is locked when you hold down the shutter button halfway after subjects are in focus with One-Shot AF in < **M** > mode with ISO Auto, <  > (Evaluative metering), and [: **AE lock meter. mode after focus**] set to the default setting ().
- When ISO Auto is set, you can press the <  > button to lock the ISO speed.
- If you press the <  > button and recompose the shot, you can see the exposure level difference on the exposure level indicator compared to when the <  > button was pressed.
- Any existing exposure compensation amount is maintained if you switch to < **M** > mode with ISO Auto after using exposure compensation in < **P** >, < **Tv** >, or < **Av** > mode ().
- To coordinate exposure compensation in 1/2-stop increments with ISO speed set in 1/3-stop increments when [: **Exposure level increments**] is set to [1/2-stop] and used with ISO Auto, exposure compensation is further adjusted by adjusting shutter speed. However, the shutter speed displayed will not change.

B: Long (Bulb) Exposures

[Bulb Timer](#)

In this mode, the shutter stays open as long as you hold down the shutter button completely, and closes when you let go of the shutter button. Use bulb exposures for night scenes, fireworks, astrophotography, and other subjects requiring long exposures.

1. Set the Mode dial to .

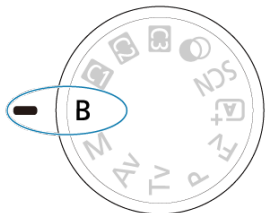

2. Set the desired aperture value.

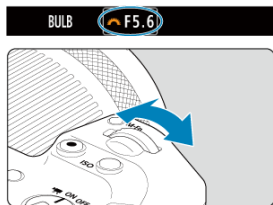

- Turn the < > dial to set it.

3. Take the picture.

- The exposure will continue for as long as you keep the shutter button pressed completely.
- Elapsed exposure time is displayed on the screen.

Caution

- Do not point the camera toward an intense light source, such as the sun or an intense artificial light source. Doing so may damage the image sensor or the camera's internal components.
- Long bulb exposures produce more noise in the image than usual.
- ISO 400 is used when the camera is set to ISO Auto.
- When shooting bulb exposures with the self-timer instead of the bulb timer, keep pressing the shutter button completely (for the self-timer time and bulb exposure time).

Note

- You can reduce the noise generated during long exposures by using [📷: Long exp. noise reduction] (🔗).
- Using a tripod and the bulb timer is recommended for bulb exposures.
- You can also shoot bulb exposures with Remote Switch RS-60E3 (sold separately, 🔗).
- You can also use Remote Controller RC-6 or Wireless Remote Control BR-E1 (both sold separately) for bulb exposures. When you press the remote controller's release (transmit) button, the bulb exposure will start immediately or 2 sec. later. Press the button again to stop the bulb exposure.

Bulb Timer



You can set the exposure time for bulb exposures in advance. This feature eliminates the need to keep holding down the shutter button during bulb exposures, which can reduce camera shake.

Note that the bulb timer can only be set and will only take effect in (bulb exposure) mode.

1. Select [📷: Bulb timer].

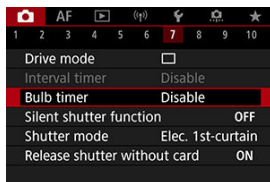

2. Select [Enable].

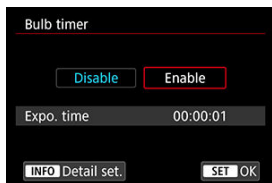

- Select [Enable], then press the < INFO > button.

3. Set the exposure time.

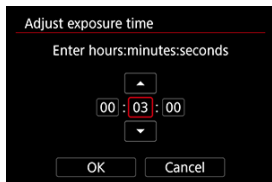

- Select an option (hours : minutes : seconds).
- Press the < [↑] > button to display [↑].
- Set a value, then press the < [↓] > button. (Returns to [□].)

4. Select [OK].

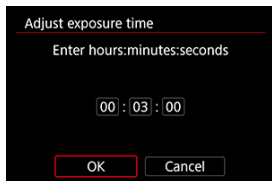

5. Take the picture.

- After you press the shutter button completely, the bulb exposure continues for your specified time.
- [**TIMER**] and the exposure time are displayed on the screen during bulb timer shooting.
- To clear the timer setting, select [**Disable**] in step 2.

Caution

- Bulb exposure stops if you press the shutter button completely and release it during the timer. Note that setting the power switch to <OFF> ends bulb timer shooting when the camera is set to [**Shooting creative filters**].
- Bulb exposure continues even after your specified exposure time if you keep pressing the shutter button completely (which overrides automatic stopping when your specified exposure time elapses).
- The bulb timer is cleared (and reverts to [**Disable**]) when you switch shooting modes.

Shooting and Recording

This chapter describes shooting and recording and introduces menu settings on the shooting [📷] tab.

- [Still Photo Shooting](#)
- [Movie Recording](#)

Still Photo Shooting

☆ to the right of titles indicates functions only available in Creative Zone modes.

- [Tab Menus: Still Photo Shooting](#)
- [Image Quality](#)
- [Dual Pixel RAW](#)
- [Still Image Aspect Ratio](#)
- [Auto Exposure Bracketing \(AEB\)](#) ☆
- [Manual Exposure Compensation](#) ☆
- [Exposure Lock \(AE Lock\)](#) ☆
- [ISO Speed Settings for Still Photos](#) ☆
- [HDR Shooting](#) ☆
- [HDR Mode](#) ☆
- [Auto Lighting Optimizer](#) ☆
- [Highlight Tone Priority](#) ☆
- [Anti-Flicker Shooting](#) ☆
- [Shooting with Speedlites](#) ☆
- [Flash Function Settings](#) ☆
- [Metering Mode](#) ☆
- [White Balance](#) ☆
- [White Balance Correction](#) ☆
- [Color Space](#) ☆
- [Picture Style Selection](#) ☆
- [Picture Style Customization](#) ☆
- [Picture Style Registration](#) ☆
- [Clarity](#) ☆
- [Shooting Creative Filters](#) ☆
- [Lens Aberration Correction](#) ☆
- [Long Exposure Noise Reduction](#) ☆
- [High ISO Speed Noise Reduction](#) ☆
- [Dust Delete Data Acquisition](#) ☆
- [Multiple Exposures](#) ☆
- [RAW Burst Mode](#) ☆
- [Focus Bracketing](#) ☆
- [Interval Timer Shooting](#)
- [Silent Shutter Function](#) ☆
- [Shutter Mode](#) ☆

- [Releasing Shutter without Card](#)
- [Image Stabilizer \(IS Mode\)](#)
- [Auto Level](#)
- [Customizing Quick Controls](#) ☆
- [Shooting with the Touch Shutter](#)
- [Image Review](#)
- [High-Speed Display](#) ☆
- [Metering Timer](#) ☆
- [Display Simulation](#) ☆
- [Optical Viewfinder Simulation](#) ☆
- [Shooting Information Display](#)
- [Reverse Display](#)
- [Viewfinder Display Format](#)
- [Display Performance](#)
- [General Still Photo Shooting](#)

Tab Menus: Still Photo Shooting

● Shooting 1



- (1) [Image quality](#)
- (2) [Dual Pixel RAW](#)
- (3) [Still img aspect ratio](#)

● Shooting 2

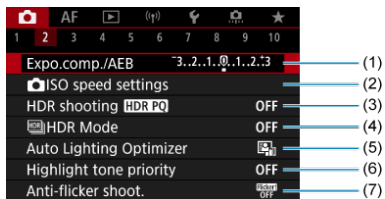

- (1) [Expo.comp./AEB](#) ☆
- (2) [ISO speed settings](#) ☆
- (3) [HDR shooting](#) [HDR PQ](#) ☆
- (4) [HDR Mode](#) ☆
- (5) [Auto Lighting Optimizer](#) ☆
- (6) [Highlight tone priority](#) ☆
- (7) [Anti-flicker shoot.](#) ☆

● Shooting 3

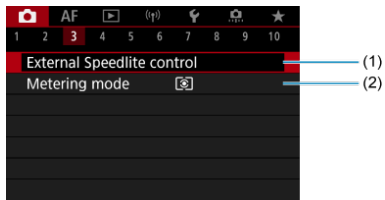

- (1) [External Speedlite control](#) ☆
- (2) [Metering mode](#) ☆

● Shooting 4

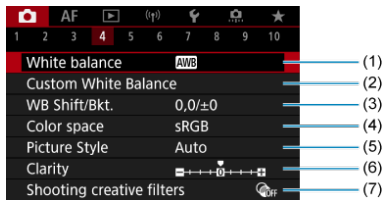

- (1) [White balance](#) ☆
- (2) [Custom White Balance](#) ☆
- (3) [WB Shift/Bkt.](#) ☆
- (4) [Color space](#) ☆
- (5) [Picture Style](#)
 - [Picture Style Selection](#) ☆
 - [Picture Style Customization](#) ☆
 - [Picture Style Registration](#) ☆
- (6) [Clarity](#) ☆
- (7) [Shooting creative filters](#) ☆

● Shooting 5

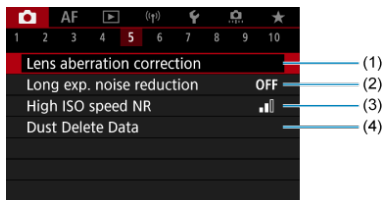

- (1) [Lens aberration correction](#) ☆
- (2) [Long exp. noise reduction](#) ☆
- (3) [High ISO speed NR](#) ☆
- (4) [Dust Delete Data](#) ☆

● Shooting 6

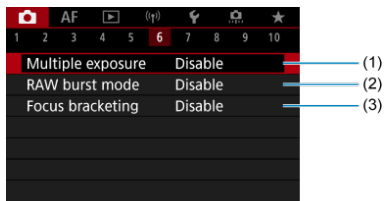

- (1) [Multiple exposure](#) ☆
- (2) [RAW burst mode](#) ☆
- (3) [Focus bracketing](#) ☆

● Shooting 7

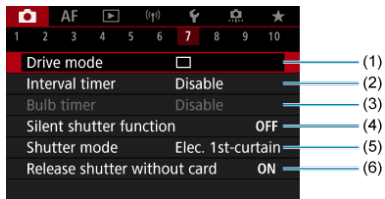

- (1) [Drive mode](#)
- (2) [Interval timer](#)
- (3) [Bulb timer](#) ☆
- (4) [Silent shutter function](#) ☆
- (5) [Shutter mode](#) ☆
- (6) [Release shutter without card](#)

● Shooting 8



- (1) [IS \(Image Stabilizer\) mode](#)
- (2) [Auto level](#)
- (3) [Customize Quick Controls](#) ☆
- (4) [Touch Shutter](#)
- (5) [Image review](#)
- (6) [High speed display](#) ☆
- (7) [Metering timer](#) ☆

● Shooting 9

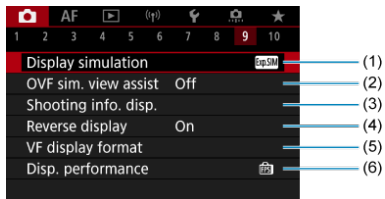

- (1) [Display simulation](#) ☆
- (2) [OVF sim. view assist](#) ☆
- (3) [Shooting info. disp.](#)
- (4) [Reverse display](#)
- (5) [VF display format](#)
- (6) [Disp. performance](#)

● Shooting 10

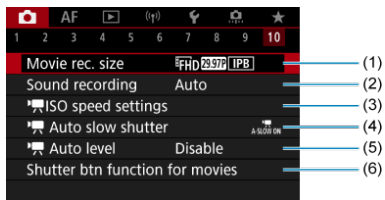

- (1) [Movie rec. size](#)
- (2) [Sound recording](#)
- (3) [ISO speed settings](#)
- (4) [Auto slow shutter](#)
- (5) [Auto level](#)
- (6) [Shutter btn function for movies](#)

In Basic Zone modes, the following screens are displayed.

● Shooting 1

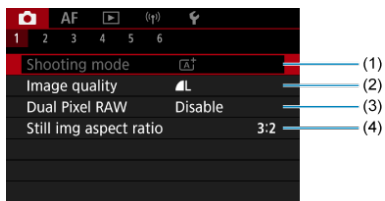

- (1) [Shooting mode](#)
- (2) [Image quality](#)
- (3) [Dual Pixel RAW](#)
- (4) [Still img aspect ratio](#)

● Shooting 2

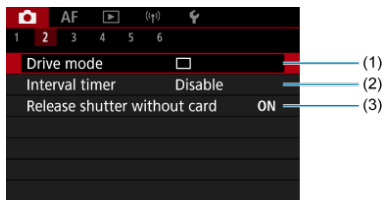

- (1) [Drive mode](#)
- (2) [Interval timer](#)
- (3) [Release shutter without card](#)

● Shooting 3

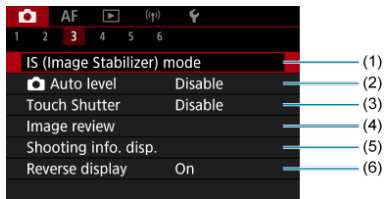

(1) [IS \(Image Stabilizer\) mode](#)

(2) [Auto level](#)

(3) [Touch Shutter](#)

(4) [Image review](#)

(5) [Shooting info. disp.](#)

(6) [Reverse display](#)

● Shooting 4

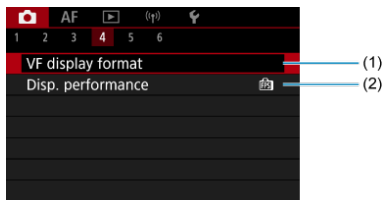

(1) [VF display format](#)

(2) [Disp. performance](#)

● Shooting 5

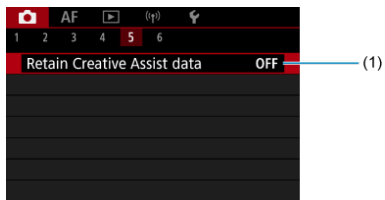

(1) [Retain Creative Assist data](#)



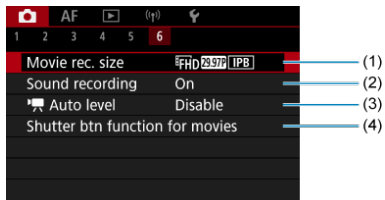



● Shooting 6



- (1) [Movie rec. size](#)
- (2) [Sound recording](#)
- (3) [Auto level](#)
- (4) [Shutter btn function for movies](#)



Image Quality

- [☑ RAW Images](#)
- [☑ Guide to Image Quality Settings](#)
- [☑ Maximum Burst for Continuous Shooting](#)

You can select the pixel count and the image quality. JPEG/HEIF image quality options are as follows:  /  /  /  /  /  / . For RAW images, you can specify **RAW** or **CRAW** as the image quality.

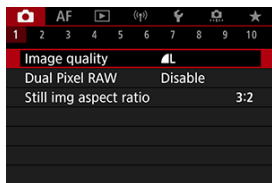
1. Select [: Image quality].





- The screen displayed varies depending on [ Rec options] settings in [: Record func+card/folder sel.].

2. Set the image quality.

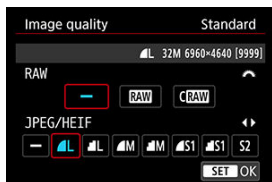
Standard/Auto switch card/Record to multiple



- For RAW images, turn the <  > dial to select the size, and for JPEG/HEIF images, turn the <  > dial.
- Press the <  > button to set it.

Record separately

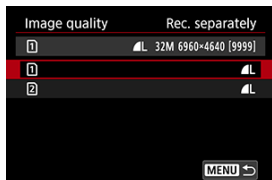





- When [ Rec options] in [ Record func+card/folder sel.] is set to [Rec. separately], turn the <  > dial to select [1] or [2], then press the <  > button. Note that recording separately to RAW and CRAW is not available for RAW images.





- Select an image quality on the screen displayed, then press the <  > button.

 **Note**

- HEIF can be specified when [: **HDR shooting** **HDR PQ**] is set to [**Enable**]. You can convert these images to JPEG images after shooting ().
-  is set if you set both RAW and JPEG/HEIF to [**—**].
- Two versions of each shot are recorded at your specified image quality when you have selected both RAW and JPEG/HEIF. Both images have the same file number but each has a different file extension, with .JPG for JPEG, .HIF for HEIF and .CR3 for RAW.
- **S2** is in  (Fine) quality.
- Meaning of image quality icons: **RAW** RAW, **CRAW** Compact RAW, JPEG, HEIF, **L** Large, **M** Medium, **S** Small.

RAW Images

RAW images are raw data from the image sensor that are recorded to the card digitally as **RAW** or **CRAW**, based on your selection. **CRAW** produces RAW images with smaller file sizes than **RAW**.

RAW images can be processed using [: **RAW image processing**] () to save them as JPEG or HEIF images. As the RAW image itself does not change, you can process the RAW image to create any number of JPEG or HEIF images with various processing conditions.

You can use Digital Photo Professional (EOS software) to process RAW images. You can make various adjustments to images depending upon how they will be used and can generate JPEG, HEIF, or other types of images reflecting the effects of those adjustments.



Note

- To display RAW images on a computer, using Digital Photo Professional (EOS software, hereafter DPP) is recommended.
- Older versions of DPP Ver. 4.x do not support display, processing, editing, or other operations with RAW images captured by this camera. If a previous version of DPP Ver. 4.x is installed on your computer, obtain and install the latest version of DPP from the Canon website to update it () , which will overwrite the previous version. Similarly, DPP Ver. 3.x or earlier does not support display, processing, editing, or other operations with RAW images captured by this camera.
- Commercially available software may not be able to display RAW images captured by this camera. For compatibility information, contact the software manufacturer.

Guide to Image Quality Settings

For details on file size, number of shots available, maximum burst, and other estimated values, see [Still photo file size / Number of shots available](#) and [Maximum burst for continuous shooting \[Approx.\]](#).

Maximum Burst for Continuous Shooting



The approximate maximum burst is displayed at the upper left of the shooting screen and lower right of the viewfinder.

Note

- If the maximum burst is displayed as "99", it indicates that you can shoot 99 or more shots continuously. Fewer shots are available for a value of 98 or lower, and when **[BUSY]** is displayed on the screen, internal memory is full and shooting will stop temporarily. If you stop continuous shooting, the maximum burst will increase. After all captured images have been written to a card, you can once again shoot at the maximum burst listed in [Maximum burst for continuous shooting \[Approx.\]](#).

Dual Pixel RAW

Shooting **RAW** or **CRAW** images with this feature enabled produces special Dual Pixel RAW images containing dual pixel information from the image sensor. This is called Dual Pixel RAW shooting.

When processing these images in Digital Photo Professional software for EOS cameras, you can take advantage of the dual pixel data to fine-tune apparent resolution (using depth information), shift the camera viewpoint slightly, and reduce ghosting.

Results will vary depending on shooting conditions, so before using this feature, refer to the Digital Photo Professional instruction manual for details on Dual Pixel RAW characteristics and image processing.

1. Select [: Dual Pixel RAW].

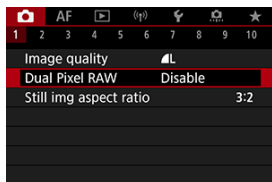

2. Select [Enable].

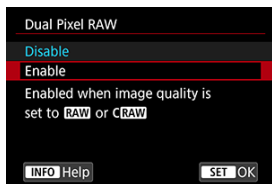

3. Set the image quality to **RAW** or **CRAW**.

- Set the image quality to **RAW**, **RAW**+JPEG, **RAW**+HEIF, **CRAW**, **CRAW**+JPEG, or **CRAW**+HEIF.

4. Take the picture.

- A RAW image containing dual pixel data (Dual Pixel RAW image) is captured.

Caution

- Startup takes longer when the power switch is set to < ON > or the camera resumes operation from auto power off.
- Continuous shooting speed is slower when you shoot with Dual Pixel RAW (📷). Maximum burst is also lower.
- [📷] and [📷] drive modes are not available. Setting the mode to [📷] or [📷] has the effect of setting it to [📷].
- Noise may be slightly more noticeable in RAW, RAW+JPEG, or RAW+HEIF images.
- These features are not available: multiple exposures, HDR shooting, RAW burst mode, focus bracketing, electronic shutter, and one-touch image quality setting.

Note

Amount and effect of Dual Pixel RAW correction

- Larger lens apertures increase the amount and effect of correction.
- The amount and effect of correction may not be sufficient with some lenses and in some shooting scenes.
- The amount and effect of correction varies depending on the camera orientation (vertical or horizontal).
- The amount and effect of correction may not be sufficient under some shooting conditions.

Still Image Aspect Ratio

You can change the image's aspect ratio.

1. Select [CAMERA]: Still img aspect ratio].

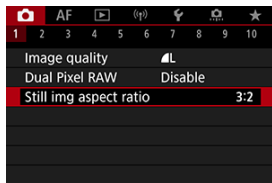

2. Set the aspect ratio.

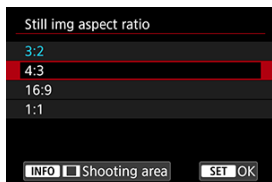

- Select an aspect ratio.
- To proceed without changing shooting area display, press the <  > button.

● JPEG images

The images will be recorded with the set aspect ratio.

● RAW Images

The images will always be recorded in the [3:2] aspect ratio. The selected aspect ratio information is added to the RAW image file, which enables Digital Photo Professional (EOS software) to generate an image with the same aspect ratio as set at the time of shooting when you process RAW images with this software.

3. Select how the shooting area is displayed.

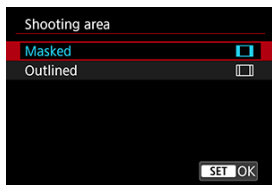

- On the screen in step 2, press the < INFO > button.
- Select the type of display, then press the < (M) > button.

Note

- RAW images shot at an aspect ratio of [4:3], [16:9], or [1:1] are displayed during playback with lines indicating the shooting area, but these lines are not recorded in the image. Note that only the shooting area is shown in slideshows (🔗).

In exposure bracketing, three consecutive images are captured at different exposures within your specified range of up to ± 3 stops (in 1/3-stop increments) by automatically adjusting the shutter speed, aperture value, or ISO speed.

* AEB stands for Auto Exposure Bracketing.

1. Select [📷: Expo.comp./AEB].

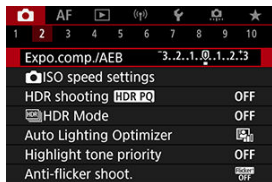

2. Set the AEB range.

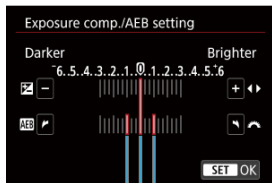

(1)

- Turn the < 🌀 > dial to set the AEB range (1). By turning the < 🕒 > dial, you can set the exposure compensation amount.
- Press the < 📷 > button to set it.
- When you close the menu, the AEB range will be displayed on the screen.

3. Take the picture.

Standard exposure



Decreased exposure

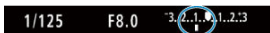

Increased exposure



- Three bracketed shots are taken, according to the specified drive mode, in this sequence: Standard exposure, decreased exposure, and increased exposure.
- AEB will not be automatically canceled. To cancel AEB, follow step 2 to turn off the AEB range display.

Caution

- Exposure compensation in AEB may be less effective with **Auto Lighting Optimizer** () set to an option other than **[Disable]**.

Note

- blinks in the lower left of the screen during AEB.
- If the drive mode is set to , press the shutter button three times for each shot. In , , or mode, holding down the shutter button completely captures three images, one after another, before the camera automatically stops shooting. When or is set, three consecutive shots are captured after a delay of 10 or 2 sec. When set to , three times the specified number of shots are taken in continuous shooting.
- You can set AEB in combination with exposure compensation.
- AEB is not available in flash photography or bulb exposures, with Multi Shot Noise Reduction, focus bracketing, or shooting creative filters, or in HDR or RAW burst mode.
- AEB will be canceled automatically if you do any of the following: Setting the power switch to **<OFF>** or when the flash is fully charged.

Exposure compensation can brighten (increased exposure) or darken (decreased exposure) the standard exposure set by the camera.

Exposure compensation is available in <Fv>, <P>, <Tv>, <Av>, and <M> modes.

For details on exposure compensation when <M> mode and ISO Auto are both set, see

[M: Manual Exposure](#), and see [Fv: Flexible-Priority AE](#) for <Fv> mode.

1. Check the exposure.

- Press the shutter button halfway and check the exposure level indicator.

2. Set the compensation amount.

Increased exposure, to brighten images





Decreased exposure, to darken images





- Set it by looking at the screen as you turn the <◉> dial.
- A  icon is displayed to indicate exposure compensation.

3. Take the picture.

- To cancel exposure compensation, set the exposure level [] to the standard exposure index ().

Caution

- If [: Auto Lighting Optimizer] () is set to any setting other than [Disable], the image may still look bright even if decreased exposure compensation is set to darken images.



Note

- The exposure compensation amount will remain in effect even after you set the power switch to <OFF>.

[Effect of AE Lock](#)

You can lock the exposure when you want to set the focus and exposure separately or when you will take multiple shots at the same exposure setting. Press the < * > button to lock the exposure, then recompose and take the picture. This is called AE lock. It is effective for shooting backlit subjects, etc.

1. Focus on the subject.

- Press the shutter button halfway.
- The exposure value will be displayed.

2. Press the < * > button (ⓘ8).



- A [*] icon is displayed in the lower left of the screen to indicate that exposure is locked (AE lock).
- Each time you press the < * > button, the current exposure setting is locked.

3. Recompose and take the picture.



- When you are to take more pictures while maintaining the AE lock, keep holding down the < * > button and press the shutter button to take another picture.

Note

- AE lock is not possible with bulb exposures.

Effect of AE Lock

Metering Mode Selection	AF Point Selection	
	Automatic Selection	Manual Selection
	Exposure centered on the AF point in focus is locked.	Exposure centered on the selected AF point is locked.
	Center-weighted exposure is locked.	

* Center-weighted exposure is locked when is set with the camera configured for manual focusing ().

[ISO Speed Range When Set Manually](#)

[ISO Speed Range Used with ISO Auto](#)

[Minimum Shutter Speed for ISO Auto](#)

Set the ISO speed (image sensor's sensitivity to light) to suit the ambient light level. In Basic Zone modes, ISO speed is set automatically.

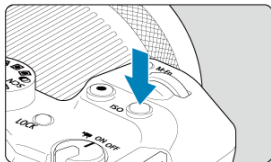

For details on ISO speed in movie recording, see [ISO Speed in Movie Recording](#).

1. Press the <ISO> button.

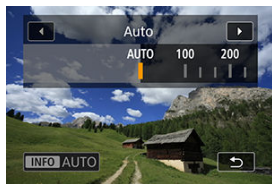

2. Set the ISO speed.



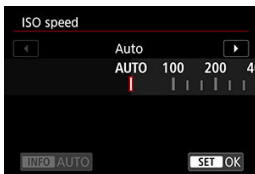

- Turn the <  > dial to set it.
- ISO speed can be set within ISO 100–32000 in 1/3-stop increments.
- With [AUTO] selected, ISO speed is set automatically.
- When [AUTO] is selected, pressing the shutter button halfway will display the ISO speed actually set.
- To specify [AUTO] when setting [ISO speed] in [:  ISO speed settings], press the < INFO > button.





ISO speed guide

- Low ISO speeds reduce image noise but may increase the risk of camera/subject shake or reduce the area in focus (shallower depth of field), in some shooting conditions.
- High ISO speeds enable low-light shooting, a larger area in focus (deeper depth of field), and longer flash range but may increase image noise.

Note

- ISO speed can also be set in the ISO speed item by pressing the < M-Fn > button with an image displayed on the screen.
- To expand the manual ISO speed setting range to H (equivalent to ISO 51200), adjust [ISO speed range] in [:  ISO speed settings] ().

Caution

- Image noise (dots of light or banding) and irregular colors may increase and apparent resolution may decrease at H (equivalent to ISO 51200), because this is an expanded ISO speed.
- Setting : **Highlight tone priority** to **[Enable]** or **[Enhanced]**  will prevent you from selecting ISO 100/125/160 or H (equivalent to ISO 51200).
- When shooting with a high ISO speed, high temperature, long exposure, or multiple exposure, image noise (graininess, dots of light, banding, etc.), irregular colors, or color shift may become noticeable.
- When shooting in conditions that produce an extreme amount of noise, such as a combination of high ISO speed, high temperature, and long exposure, images may not be recorded properly.
- If you use a high ISO speed and flash to shoot a close subject, overexposure may result.

ISO Speed Range When Set Manually

You can set the manual ISO speed setting range (minimum and maximum limits). You can set the minimum limit within ISO 100 to ISO 32000 and the maximum limit within ISO 200 to H (equivalent to ISO 51200).

1. Select [ISO speed settings].

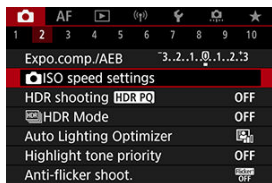

2. Select [ISO speed range].

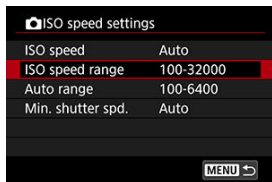

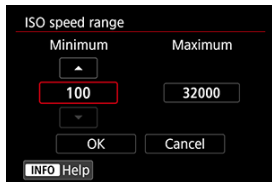

3. Set [Minimum].

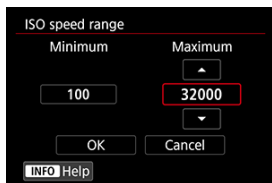

- Select the [Minimum] box, then press the < > button.
- Select an ISO speed, then press the < > button.

4. Set [Maximum].



- Select the [**Maximum**] box, then press the <  > button.
- Select an ISO speed, then press the <  > button.

5. Select [OK].

ISO Speed Range Used with ISO Auto

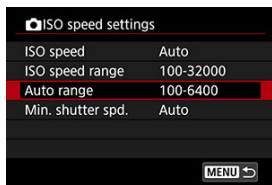

You can set the automatic ISO speed range for ISO Auto within ISO 100–32000. The minimum can be set within ISO 100–25600 and the maximum within ISO 200–32000, in 1-stop increments.

1. Select [Auto range].



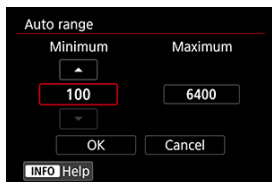

2. Set [Minimum].

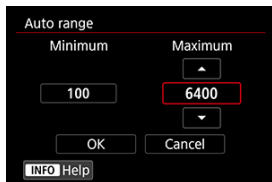

- Select the **[Minimum]** box, then press the <  > button.
- Select an ISO speed, then press the <  > button.

3. Set [Maximum].



- Select the **[Maximum]** box, then press the <  > button.
- Select an ISO speed, then press the <  > button.

4. Select [OK].

Note

- The **[Minimum]** and **[Maximum]** settings will also function as the minimum and maximum speeds for ISO speed safety shift ().

Minimum Shutter Speed for ISO Auto

To prevent shutter speeds from being set too low automatically, you can set the minimum shutter speed for ISO Auto.

This is effective in < **P** > or < **Av** > mode when shooting subjects in motion with a wide-angle lens, or when using a telephoto lens. It can also reduce camera shake and blurred subjects.

1. Select [Min. shutter spd.].

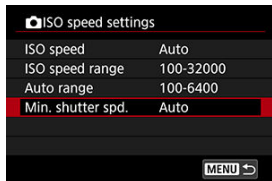

2. Set the desired minimum shutter speed.

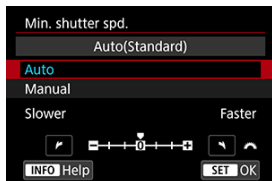

Auto



- If you select **[Auto]**, turn the <  > dial to set the difference relative to standard speed (toward **Slower** or **Faster**), then press the <  > button.

Manual



- If you select **[Manual]**, turn the <  > dial to select the shutter speed, then press the <  > button.

Caution

- If a correct exposure cannot be obtained with the maximum ISO speed limit set with **[Auto range]**, a shutter speed slower than the **[Min. shutter spd.]** will be set to obtain the standard exposure.
- This function will not be applied to flash photography.

Note

- When **[Auto(Standard)]** is set, the minimum shutter speed will be the reciprocal of the lens focal length. A single step from **[Slower]** to **[Faster]** is equivalent to a single stop of the shutter speed.

PQ in HDR PQ refers to the gamma curve of the input signal for displaying HDR images. HDR PQ settings enable the camera to produce HDR images conforming to the PQ specification defined in ITU-R BT.2100 and SMPTE ST.2084. (Actual display depends on monitor performance.)

Shots are captured as HEIF or RAW images.

* HDR stands for High Dynamic Range.

* PQ stands for Perceptual Quantization.

1. Select [📷: HDR shooting (HDR PQ)].

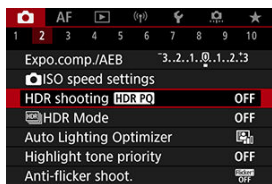

2. Select [Enable].

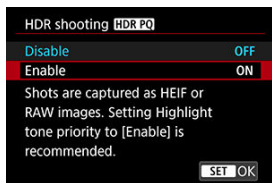

- On the screen during shooting and playback, converted images are displayed that resemble how the images would look on an HDR display device.

 **Caution**

- Expanded ISO speeds (H) are not available in HDR shooting.
- Some scenes may look different from how they appear on an HDR display device.
- Unused signal values are roughly indicated by image areas in gray in the histogram when **[📷: HDR shooting HDR PQ]** is set to **[Enable]**.
- **[📷: Disp. performance]** is not available when **[📷: HDR shooting HDR PQ]** is set to **[Enable]**. It is set to **[Smooth]**.
- For images captured with **[📷: HDR shooting HDR PQ]** set to **[Enable]**, before playback on an HDR display device, set **[▶: HDMI HDR output]** to **[On]** . Note that regardless of the **[▶: HDMI HDR output]** setting, HDR images are used for display on HDR display devices.

You can shoot still photos with clipped highlights and shadows reduced for a high dynamic range of tones even in high-contrast scenes. HDR shooting is effective for landscape and still-life shots.

HDR shooting enhances gradation in dark image areas by merging three images deliberately captured at different exposures (standard, underexposed, and overexposed) to produce an HDR image that compensates for loss of detail in dark image areas. HDR images are captured as HEIFs or JPEGs.

* HDR stands for High Dynamic Range.

1. Select [HDR] HDR Mode].

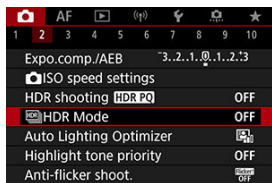

2. Set [Adjust dyn range].

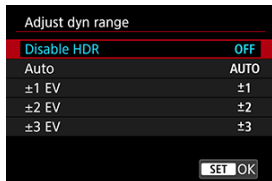

- Selecting [**Auto**] will have the dynamic range set automatically depending on the image's overall tonal range.
- The higher the number, the wider the dynamic range will be.
- To exit HDR shooting, select [**Disable HDR**].

3. Set [Limit max brightness] (only with [📷: HDR shooting **HDR PQ**] set to [Enable]).



- With [Disable], maximum brightness is not limited. Recommended when you will review images on a monitor supporting display at brightnesses exceeding 1000 nits.
- With [1000 nits], maximum brightness is limited to approx. 1000 nits.

4. Set [Continuous HDR].

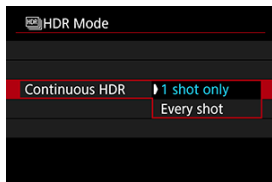

- With [1 shot only], HDR shooting is canceled automatically after you finish shooting.
- With [Every shot], HDR shooting continues until the setting in step 2 is set to [Disable HDR].

5. Set [Auto Image Align].

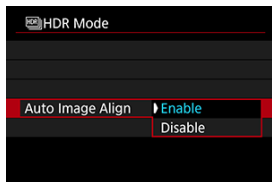

- For handheld shooting, select [**Enable**]. When using a tripod, select [**Disable**].

6. Specify the images to save.

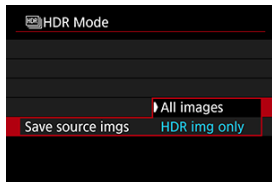



- To save the three images captured and the resulting HDR image, select [**All images**].
- To save only the HDR image, select [**HDR img only**].



7. Take the picture.

- When you press the shutter button completely, three consecutive images will be captured, and the HDR image will be recorded to the card.

Caution

- Expanded ISO speeds (H) are not available in HDR shooting.
- The flash will not fire during HDR shooting.
- AEB is not available.
- In HDR shooting, three images are captured with settings such as shutter speed automatically adjusted. For this reason, even in < **Fv** >, < **Tv** >, and < **M** > modes, the shutter speed and ISO speed will change, relative to your specified speed.
- To prevent camera shake, a high ISO speed may be set.
- When shooting HDR images with [**Auto Image Align**] set to [**Enable**], AF point display information () and Dust Delete Data () will not be appended to the image.
- If you perform handheld HDR shooting with [**Auto Image Align**] set to [**Enable**], image periphery will be slightly trimmed and resolution will be slightly lowered. Also, if the images cannot be aligned properly due to camera shake, etc., auto image alignment may not take effect. Note that when shooting with excessively bright (or dark) exposure settings, auto image alignment may not work properly.
- If you perform handheld HDR shooting with [**Auto Image Align**] set to [**Disable**], the three images may not be properly aligned and the HDR effect may be reduced. Using a tripod is recommended.
- Auto image alignment may not function properly with repetitive patterns (lattice, stripes, etc.) or flat, single-tone images.
- Subjects such as the sky or white walls may not be rendered with smooth gradation and may have noise or irregular exposure or colors.
- HDR shooting under fluorescent or LED lighting may cause issues such as irregular exposure or colors in HDR images, due to the flickering light source. Effects of flickering may be reduced by setting [**Anti-flicker shoot.**] to [**Enable**].
- With HDR shooting, the images will be merged, then saved to the card, so it may take some time. [**BUSY**] appears on the screen as images are processed, and shooting is not possible until processing is finished.
- Maximum shutter speed in HDR shooting with an electronic shutter is 1/8000 sec.

Note

- Image quality of RAW HDR images is as follows.
 - [: **HDR shooting HDR PQ**] set to [**Disable**]: JPEG quality
 - [: **HDR shooting HDR PQ**] set to [**Enable**]: HEIF qualityHDR image quality in RAW+JPEG or RAW+HEIF shooting corresponds to your specified JPEG or HEIF image quality.

Brightness and contrast can be corrected automatically if shots look dark or contrast is too low or high.

1. Select [📷: Auto Lighting Optimizer].

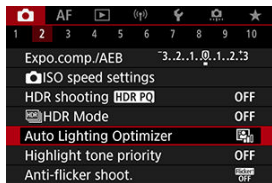

2. Set a correction option.



⚠ Caution

- Noise may increase and apparent resolution may change, under some shooting conditions.
- If the effect of Auto Lighting Optimizer is too strong and results are not at your preferred brightness, set to [Low] or [Disable].
- If a setting other than [Disable] is set and you use exposure compensation or flash exposure compensation to darken the exposure, the image may still come out bright. If you want a darker exposure, set this function to [Disable].



Note

- For **RAW** and **CRAW** images, face lighting can be adjusted in [**▶**]: **RAW image processing**] (2).
- To enable [**📷**: **Auto Lighting Optimizer**] to be set even in <**M**> and <**B**> modes, press the <**INFO**> button in step 2 to clear the checkmark [✓] for [**Disabled in M or B modes**].

You can reduce overexposed, clipped highlights.

1. Select [📷: Highlight tone priority].

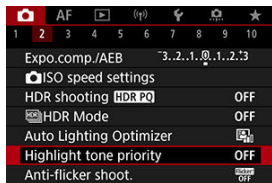

2. Set an option.

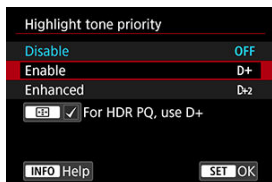

- **[Enable]**: Improves gradation in highlights. The gradation between the grays and highlights becomes smoother.
- **[Enhanced]**: Reduces overexposed highlights even more than **[Enable]**, under some shooting conditions.

⚠ Caution

- Noise may increase slightly.
- The available ISO range starts at ISO 200. Expanded ISO speeds cannot be set.
- With **[Enhanced]**, results in some scenes may not look as expected.



Note

- **[📷: Highlight tone priority]** is set to **[Enable]** and cannot be changed after you set **[📷: HDR shooting HDR PQ]** to **[Enable]** by pressing the **< [☰] >** button to add a checkmark to this setting.
- **[📷: Highlight tone priority]** will be set to **[Disable]** even if you set **[📷: HDR shooting HDR PQ]** to **[Enable]**, with **[Adjust dyn range]** in **[📷: HDR Mode]** set to an option other than **[Disable HDR]**.

Uneven exposure and color may appear in continuous shooting at fast shutter speeds under flickering light sources such as fluorescent lights, due to uneven vertical exposure. Anti-flicker shooting enables you to take pictures when exposure and colors are less affected by flickering.

1. Select [: Anti-flicker shoot.].

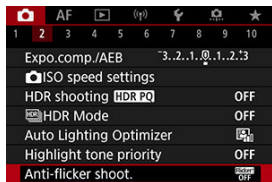

2. Select [Enable].

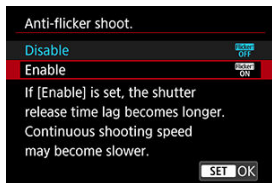

3. Take the picture.

Caution

- When **[Enable]** is set and you shoot under a flickering light source, the shutter-release time lag may become longer. Also, the continuous shooting speed may become slower, and the shooting interval may become irregular.
- Flicker at a frequency other than 100Hz or 120Hz cannot be detected. Also, if the flickering frequency of the light source changes during continuous shooting, effects of the flicker cannot be reduced.
- In **<Fv>**, **<P>**, or **<Av>** mode, color tone of captured images may vary if the shutter speed changes during continuous shooting or if you take multiple shots of the same scene at different shutter speeds. To avoid inconsistent color tone, shoot in **<Fv>**, **<M>**, or **<Tv>** mode at a fixed shutter speed.
- Color tone of captured images may vary between **[Enable]** and **[Disable]**.
- Shutter speed, aperture value, and ISO speed may change when you start shooting with AE lock.
- If the subject is against a dark background or if there is a bright light in the image, flicker may not be properly detected.
- Flicker reduction may not be possible under special lighting.
- Depending on the light source, flicker may not be detected properly.
- Depending on the light sources or shooting conditions, the expected result may not be obtained even if you use this function.

Note

- Taking test shots in advance is recommended.
- Detect flicker manually if the screen flickers (as when the light source changes) by pressing the **<G>** button, selecting **[Anti-flicker shoot.]**, then pressing the **<INFO>** button.
- Flicker is not reduced in Basic Zone modes.
- Flicker reduction also works with flash photography. However, the expected result may not be obtained for wireless flash photography.

- ☑ [EL/EX Series Speedlites for EOS Cameras](#)
- ☑ [Canon Speedlites Other Than the EL/EX Series](#)
- ☑ [Non-Canon Flash Units](#)

EL/EX Series Speedlites for EOS Cameras

Features of EL/EX series Speedlites (sold separately) can be used in flash photography with the camera.



For instructions, refer to the EL/EX series Speedlite's Instruction Manual.

● Sync speed

Varies depending on the shutter mode.

 Shutter mode] Setting	Sync Speed
Mechanical	1/250 sec. or slower
Elec. 1st-curtain	1/320 sec. or slower





● Flash exposure compensation

You can adjust flash output (flash exposure compensation). With an image displayed on the screen, press the <  > button, turn the <  > dial to select the flash exposure compensation item, then turn the <  > dial to set the flash exposure compensation amount.



● FE Lock

This enables you to obtain appropriate flash exposure for a specific part of the subject. Aim the viewfinder center over the subject, press the camera's <  > button, then compose the shot and take the picture.

Caution

- Some Speedlites cannot be attached directly to this camera. For details, see [Multi-Function Shoe](#).
- Setting [: **Auto Lighting Optimizer**] () to an option other than [**Disable**] may still cause images to look bright even if you set lower flash exposure compensation for darker images.
- In flash photography, set [: **Shutter mode**] to an option other than [**Electronic**] ()

Note

- The Speedlite will fire an intermittent AF-assist beam as needed, if autofocusing is difficult under low light.
- You can also set flash exposure compensation in [**Flash function settings**] in [: **External Speedlite control**] ()
- The camera can turn on certain Speedlites automatically when the camera is turned on. For details, refer to the instruction manual of Speedlites that support this feature.

Canon Speedlites Other Than the EL/EX Series

- With an EZ/E/EG/ML/TL series Speedlite set to A-TTL or TTL autoflash mode, the flash can be fired at full output only.
Set the camera's shooting mode to < **M** > or < **Av** > and adjust the aperture value before shooting.
- When using a Speedlite that has manual flash mode, shoot in the manual flash mode.

Non-Canon Flash Units

● Sync speed

Sync speed for non-Canon compact flash units varies by shutter mode.

 Shutter mode] Setting	Sync Speed
Mechanical	1/250 sec. or slower
Elec. 1st-curtain	1/320 sec. or slower

With large studio flash units, the flash duration is longer than that of a compact flash unit and varies depending on the model. Before shooting, confirm that flash sync is performed correctly by taking some test shots at a sync speed of approx. 1/60 sec. to 1/30 sec.



Caution

- Using the camera with a dedicated flash unit or flash accessory for cameras of other manufacturers poses a risk of malfunction and even damage.
- Do not attach a high-voltage flash unit to the camera's multi-function shoe. It may not fire.

- [Flash Firing](#)
- [E-TTL Balance](#)
- [E-TTL II Flash Metering](#)
- [Continuous Flash Control](#)
- [Slow Synchro](#)
- [Flash Function Settings](#)
- [Flash Custom Function Settings](#)
- [Clearing Flash Function Settings/Clearing All Speedlite Custom Functions](#)

Functions of EL/EX Series Speedlites compatible with flash function settings can be set via a camera menu screen. Attach the Speedlite to the camera and turn on the Speedlite before setting the flash functions.

For details on the Speedlite's functions, refer to the Speedlite's Instruction Manual.

1. Select [: External Speedlite control].

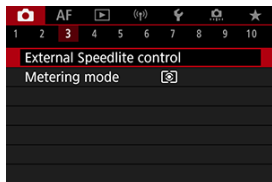

2. Select an option.

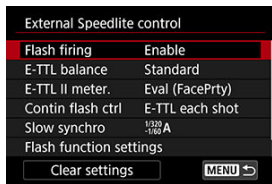

Flash Firing

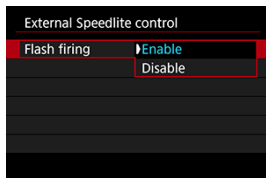

To enable flash photography, set to **[Enable]**. To enable only the AF-assist beam of the Speedlite, set to **[Disable]**.

E-TTL Balance

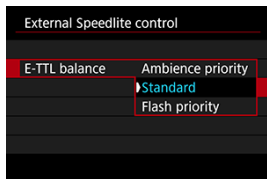

You can set your preferred appearance (balance) for flash shots. This setting enables you to adjust the ratio of ambient light to Speedlite light output.

- Set the balance to **[Ambience priority]** to lower the proportion of flash output and uses ambient light to produce lifelike shots with a natural mood. Especially useful when shooting dark scenes (indoors, for example). After switching to < **Av** > or < **P** > mode, consider setting **[Slow synchro]** in **[CAMERA: External Speedlite control]** to **[1/320-30 sec. auto]** (or **[1/250-30sec. auto]**) and using slow-sync shooting.
- Set the balance to **[Flash priority]** to make the flash the main source of light. Useful for reducing shadows on subjects and in the background from ambient light.

⚠ Caution

- For some scenes, **[Ambience priority]** may yield the same results as **[Standard]**.

E-TTL II Flash Metering

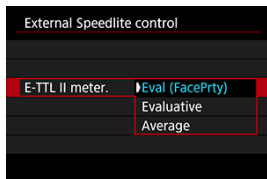

- Set to **[Eval (FacePrty)]** for flash metering suitable for shots of people.
- Set to **[Evaluative]** for flash metering that emphasizes firing in continuous shooting.
- If **[Average]** is set, the flash exposure will be averaged for the entire metered scene.



Note

- Depending on the scene, flash exposure compensation may be necessary.



Caution

- Even when **[Eval (FacePrty)]** is set, some subjects and shooting conditions may prevent you from obtaining the expected result.

Continuous Flash Control

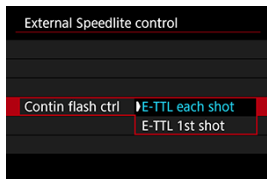

- Set to **[E-TTL each shot]** to perform flash metering for each shot.
- Set to **[E-TTL 1st shot]** to perform flash metering for only the first shot before continuous shooting. The flash output level for the first shot is applied to all subsequent shots. Useful when prioritizing continuous shooting speed without recomposing shots.

⚠ Caution

- Any subject movement in continuous shooting may cause exposure problems.
- **[E-TTL 1st shot]** is set automatically in  drive mode.

Slow Synchro

You can set the flash-sync speed for flash photography in <Av> or <P> mode. Note that the maximum flash synchronization speed varies depending on the [CAMERA: Shutter mode] setting. It is 1/320 sec. when set to [Elec. 1st-curtain] and 1/250 sec. when set to [Mechanical].

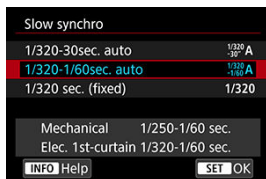

- **1/320-30 sec. auto** ($\frac{1}{320}$ - $\frac{1}{30}$ A)*1

Shutter speed is automatically set in the following range to suit brightness. High-speed sync is also possible.

[CAMERA: Shutter mode] Setting	Shutter Speed
Mechanical	1/250–30 sec.
Elec. 1st-curtain	1/320–30 sec.

● **1/320-1/60 sec. auto** ($\frac{1}{320}$ – $\frac{1}{60}$ A)*1

Prevents a slow shutter speed from being set automatically in low-light conditions. Effective for preventing subject blur and camera shake. Light from the flash provides standard exposure for subjects, but note that backgrounds may be dark.

[📷: Shutter mode] Setting	Shutter Speed
Mechanical	1/250–1/60 sec.
Elec. 1st-curtain	1/320–1/60 sec.

● **1/320 sec. (fixed)** ($\frac{1}{320}$)*1

Shutter speed is fixed as follows, which is more effective in preventing subject blur and camera shake than with [1/320-1/60 sec. auto].

[📷: Shutter mode] Setting	Shutter Speed
Mechanical	1/250 sec.
Elec. 1st-curtain	1/320 sec.

Note that under low light, backgrounds will be darker than with [1/320-1/60 sec. auto].

* 1: When set to [Elec. 1st-curtain].

⚠ **Caution**

- High-speed sync is not available in < **P** > or < **Av** > mode when set to [1/320 sec. (fixed)].

Flash Function Settings

The information displayed on the screen, position of display, and available options vary depending on the Speedlite model, its Custom Function settings, the flash mode, and other factors. For details on the Speedlite's functions, refer to the Speedlite's Instruction Manual.

Sample display

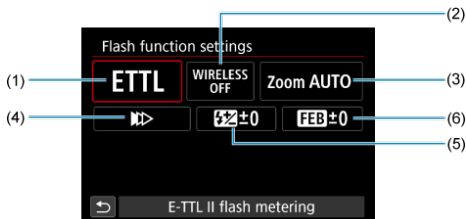

- (1) Flash mode
- (2) Wireless functions/
Firing ratio control (RATIO)
- (3) Flash zoom (flash coverage)
- (4) Shutter synchronization
- (5) Flash exposure compensation
- (6) Flash exposure bracketing

Caution

- Functions are limited when using EX series Speedlites that are not compatible with flash function settings.

Flash mode

You can select the flash mode to suit your desired flash photography.

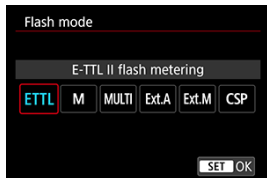

- **[E-TTL II flash metering]** is the standard mode of EL/EX series Speedlites for automatic flash photography.
- **[Manual flash]** is for setting the Speedlite's **[Flash output level]** yourself.
- **[CSP]** (Continuous shooting priority mode) is available when using a compatible Speedlite. This mode automatically reduces flash output by one stop and increases ISO speed by one stop. Useful in continuous shooting, and helps conserve flash battery power.
- Regarding other flash modes, refer to the Instruction Manual of a Speedlite compatible with the respective flash mode.

⚠ Caution

- Adjust exposure compensation (☒) as needed in case of overexposure from flash photography with **[CSP]** in **< Fv >**, **< Tv >**, or **< M >** mode.

📄 Note

- With **[CSP]**, ISO speed is automatically set to **[Auto]**.

Wireless functions



You can use radio or optical wireless transmission to shoot with wireless multiple-flash lighting.

For details on wireless flash, refer to the Instruction Manual of a Speedlite compatible with wireless flash photography.

Firing ratio control (RATIO)

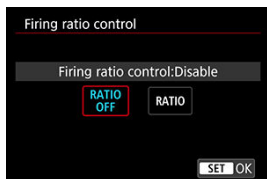

With a macro flash, you can set the firing ratio control.

For details on firing ratio control, refer to the Instruction Manual of the macro flash.

Flash zoom (flash coverage)

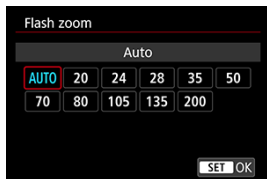

With Speedlites having a zooming flash head, you can set the flash coverage.

Shutter synchronization

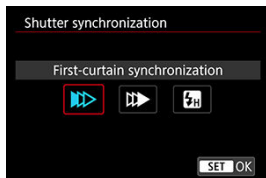

Normally, set this to [**First-curtain synchronization**] so that the flash fires immediately after the shooting starts.

Set to [**Second-curtain synchronization**] and use low shutter speeds for natural-looking shots of subject motion trails, such as car headlights.

Set to [**High-speed synchronization**] for flash photography at higher shutter speeds than the maximum flash sync shutter speed. This is effective when shooting with an open aperture in < **Av** > mode to blur the background behind subjects outdoors in daylight, for example.

Caution

- When using second-curtain synchronization, set the shutter speed to 1/30 sec. or slower. If the shutter speed is 1/40 sec. or faster, first-curtain synchronization will be applied automatically even if [**Second-curtain synchronization**] is set.

Flash exposure compensation

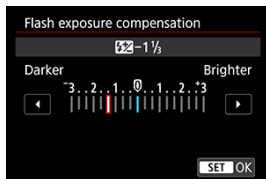

Just as exposure compensation is adjustable, you can also adjust flash output.

Note

- If flash exposure compensation is set with the Speedlite, you cannot set the flash exposure compensation with the camera. If it is set with both the camera and Speedlite, the Speedlite's setting overrides the camera's.

Flash exposure bracketing

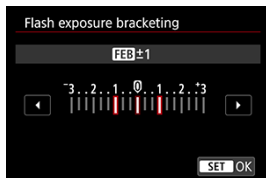

Speedlites equipped with flash exposure bracketing (FEB) can change the external flash output automatically as three shots are taken at once.

Flash Custom Function Settings

For details on the Speedlite's Custom Functions, refer to the Instruction Manual of the Speedlite.

1. Select [Flash C.Fn settings].

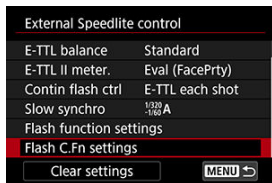

2. Set the desired functions.

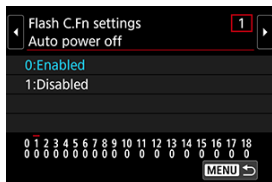

- Select the number.
- Select an option.

Caution

- With an EL/EX series Speedlite, the Speedlite will always fire at full output if the [Flash metering mode] Custom Function is set to [1:TTL] (autoflash).
- The Speedlite's Personal Function (P.Fn) cannot be set or canceled from the camera's [📷: External Speedlite control] screen. Set it directly on the Speedlite.

Clearing Flash Function Settings/Clearing All Speedlite Custom Functions

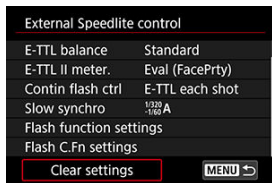

1. Select [Clear settings].

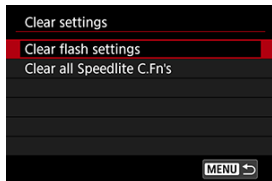

2. Select the settings to be cleared.



- Select [Clear flash settings] or [Clear all Speedlite C.Fn's].
- Select [OK] on the confirmation screen to clear all flash settings or Custom Function settings.



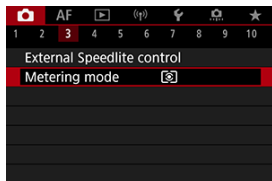

Four methods (metering modes) to measure the subject's brightness are provided. Normally, evaluative metering is recommended. Evaluative metering is set automatically in Basic Zone modes (except in <  :  > mode, which uses center-weighted average metering).

1. Select [: Metering mode].

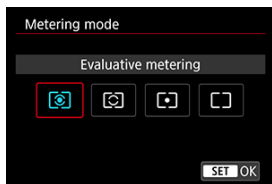







2. Select an option.



- : **Evaluative metering**
General-purpose metering mode suited even for backlit subjects. The camera adjusts the exposure automatically to suit the scene.
- : **Partial metering**
Effective where there are much brighter lights around the subject due to backlight, etc. The partial metering area is indicated on the screen.
- : **Spot metering**
Effective when metering a specific part of the subject. The spot metering area is indicated on the screen.
- : **Center-weighted average**
The metering across the screen is averaged, with the center of the screen weighted more heavily.

 Caution

- With  (evaluative metering), holding down the shutter button halfway when shooting with **[One-Shot AF]** locks the exposure value (AE lock). With  (partial metering),  (spot metering), or  (center-weighted average metering), exposure is set at the moment the picture is taken (without locking the exposure value when the shutter button is pressed halfway).
- With : **AE lock meter. mode after focus** , you can set whether or not to lock the exposure (AE lock) once subjects are in focus with One-Shot AF.

- ☑ [White Balance](#)
- ☑ [\[AWB\] Auto White Balance](#)
- ☑ [\[\] Custom White Balance](#) ☆
- ☑ [\[K\] Color Temperature](#)

White balance (WB) is for making the white areas look white. Normally, the Auto [AWB] (Ambience priority) or [AWBW] (White priority) setting will obtain the correct white balance. If natural-looking colors cannot be obtained with Auto, you can select the white balance to match the light source or set it manually by shooting a white object.

In Basic Zone modes, [AWB] (Ambience priority) is set automatically. ([AWBW] (White priority) is set in <M-Fn> mode.)

1. Press the <M-Fn> button (Ⓞ6).

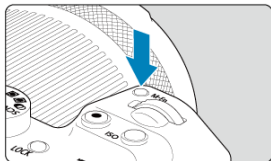

- With an image displayed on the screen, press the <M-Fn> button.

2. Select the white balance item.



- Turn the <⦿> dial to select the white balance setting item.

3. Select a white balance setting.









- Turn the <  > dial to make a selection.

Note

- For **[AWB]** and **[AWBW]** setting instructions, see [\[AWB\] Auto White Balance](#).
- To set your preferred color temperature, select **[K]** in **[📷: White balance]**, then turn the <  > dial.

(Approx.)

Display	Mode	Color Temperature (K: Kelvin)
[AWB]	Auto (Ambience priority)	3000–7000
[AWBW]	Auto (White priority)	
	Daylight	5200
	Shade	7000
	Cloudy, twilight, sunset	6000
	Tungsten light	3200
	White fluorescent light	4000
	When using Flash	Automatically set*
	Custom	2000–10000
[K]	Color temperature	2500–10000

* Applicable with Speedlites having a color temperature transmission function. Otherwise, it will be fixed to approx. 6000K.

White Balance

The human eye adapts to changes in lighting so that white objects look white under all kinds of lighting. Cameras determine white from the color temperature of lighting and, based on this, apply image processing to make color tones look natural in your shots.

[AWB] Auto White Balance

With [AWB] (Ambience priority), you can slightly increase the intensity of the image's warm color cast when shooting a tungsten-light scene.

If you select [AWBW] (White priority), you can reduce the intensity of the image's warm color cast.

1. Select [📷: White balance].

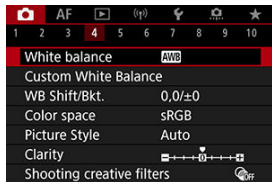

2. Select [AWB].



- With [AWB] selected, press the < [←] > button.

3. Select an option.

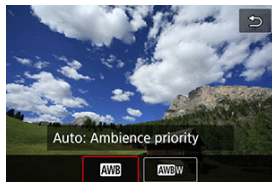

 Caution

Precautions when set to [AWBW] (White priority)

- The warm color cast of subjects may fade.
- When multiple light sources are included in the scene, the warm color cast of the picture may not be reduced.
- When using flash, the color tone will be the same as with [AWB] (Ambience priority).

With custom white balance, you can manually set the white balance for the specific light source of the shooting location. Make sure to perform this procedure under the light source at the actual location of the shoot.

Registration from an image on a card

1. Shoot a white object.

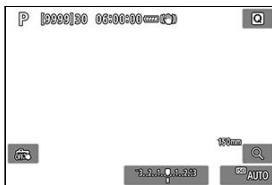

- Aim the camera at a plain white object, so that white fills the screen.
- Set the camera to manual focus () and shoot so that the white object has standard exposure.
- You can use any of the white balance settings.

Caution

- Correct white balance may not be obtained if the exposure of your image differs greatly from standard exposure.
- These images cannot be selected: images captured with the Picture Style set to **[Monochrome]**, images from multiple-exposure or RAW burst shooting, images that are cropped or have a Creative filter applied, or images from another camera.

2. Select [: Custom White Balance].

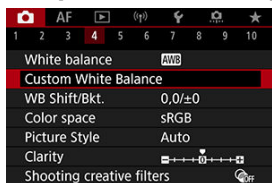

3. Import the white balance data.



- Turn the < > dial to select the image captured in step 1, then press the < > button.
- Select [**OK**] to import the data.

4. Select [: White balance].

5. Select the custom white balance.



- Select [].

Shooting and registering white balances





1. Press the  button.
2. Select the white balance item.

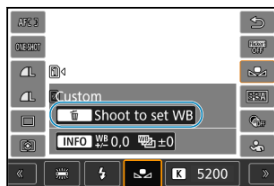

- Press  up or down for selection.

3. Select [Shoot to set WB].



- Turn the  dial or press  left or right to select , then press the  button.

4. Shoot a white object.

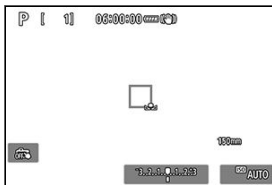

- Aim the camera at a plain white object, so that white fills the screen.
- Set the camera to manual focus (MF) and shoot so that the white object has standard exposure.
- The custom white balance is registered to the camera.

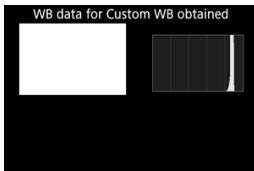

⚠ Caution

- Correct white balance may not be obtained if the exposure of your image differs greatly from standard exposure.

📄 Note

- Instead of shooting a white object, you can also shoot a gray card or standard 18% gray reflector (commercially available).

[K] Color Temperature

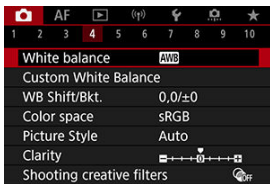

A value can be set representing the white balance color temperature.

1. Select [☑: White balance].

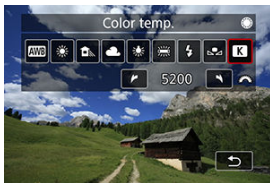

2. Set the color temperature.



- Select [K].
- Turn the <  > dial to set a color temperature, then press the <  > button.
- The color temperature can be set from approx. 2500K to 10000K in 100K increments.

Note

- When setting the color temperature for an artificial light source, set the white balance correction (magenta or green bias) as necessary.
- When setting [K] to a value measured with a commercially available color temperature meter, take some test shots in advance and adjust the setting as needed to compensate for any difference between the color temperature meter and the camera.

[White Balance Correction](#)

[White Balance Auto Bracketing](#)

You can correct the white balance that is set. This adjustment will have the same effect as using a commercially available color temperature conversion filter or color compensating filter.

White Balance Correction

1. Select [: WB Shift/Bkt.].

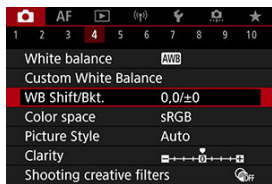

2. Set the white balance correction.

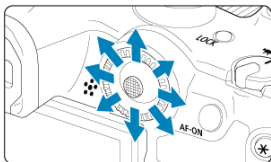

Sample setting: A2, G1

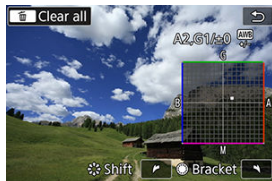

- Use < * > to move the "■" mark on the screen to your preferred position.
- B is for blue, A for amber, M for magenta, and G for green. White balance is corrected in the direction you move the mark.
- The direction and amount of correction are indicated in the upper right of the screen.
- Pressing the < [trash] > button will cancel all the [WB Shift/Bkt.] settings.
- Press the < [exit] > button to exit setup.

Note

- One level of the blue/amber correction is equivalent to approx. 5 mireds of a color temperature conversion filter. (Mired: Unit of measure for color temperature used to indicate values such as the density of a color temperature conversion filter.)

White Balance Auto Bracketing

White balance bracketing enables you to capture three images at once with different color tones.

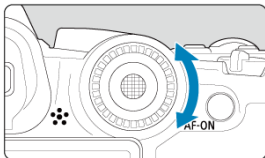

Setting the white balance bracketing amount



- In step 2 for [White Balance Correction](#), when you turn the <  > dial, the "■" mark on the screen will change to "■ ■ ■" (3 points). Turning the dial clockwise sets the B/A bracketing, and turning it counterclockwise sets the M/G bracketing.

B/A bias ± 3 levels



- The direction and amount of bracketing are indicated in the upper right of the screen.
- Pressing the <  > button will cancel all the [WB Shift/Bkt.] settings.
- Press the <  > button to exit setup.

Caution

- During white balance bracketing, the maximum burst for continuous shooting will be lower.
- Since three images are recorded for one shot, it takes longer to record the image to the card.



Note

- The images will be bracketed in the following sequence: 1. Standard white balance, 2. Blue (B) bias, and 3. Amber (A) bias, or 1. Standard white balance, 2. Magenta (M) bias, and 3. Green (G) bias.
- You can also set white balance correction and AEB together with white balance bracketing. If you set AEB in combination with white balance bracketing, a total of nine images will be recorded for a single shot.
- The white balance icon blinks to indicate that white balance bracketing has been set.
- You can change the bracketing sequence (☞) and number of shots (☞) for the white balance bracketing.
- **Bracket** stands for bracketing.

The range of reproducible colors is called the “color space.” For normal shooting, sRGB is recommended.

In Basic Zone, [sRGB] is set automatically.

1. Select [📷: Color space].
2. Set a color space option.

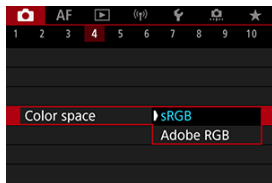

- Select [sRGB] or [Adobe RGB], then press the < (📷) > button.

Adobe RGB

This color space is mainly used for commercial printing and other professional applications. Recommended when using equipment such as Adobe RGB-compatible monitors or DCF 2.0 (Exif 2.21 or later) compatible printers.

Note

- File names of still photos shot in the Adobe RGB color space begin with “_”.
- The ICC profile is not appended. For the descriptions about the ICC profile, refer to the Digital Photo Professional Instruction Manual (EOS software).

☑ [Picture Style Characteristics](#)

☑ [Symbols](#)

Just by selecting a preset Picture Style, you can obtain image characteristics effectively matching your photographic expression or the subject.

1. Select [📷: Picture Style].

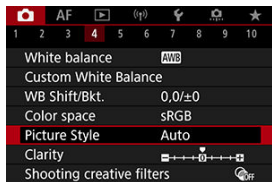

2. Select a Picture Style.



Picture Style Characteristics

-  **Auto**

The color tone will be adjusted automatically to suit the scene. The colors will look vivid for blue skies, greenery and sunsets, particularly in nature, outdoor, and sunset scenes.

 **Note**

- If the desired color tone is not obtained with **[Auto]**, use another Picture Style.

-  **Standard**

The image looks vivid, sharp, and crisp. Suitable for most scenes.

-  **Portrait**

For smooth skin tones, with slightly less sharpness. Suited for close-up portraits. Skin tone can be adjusted by changing **[Color tone]** as described in [Settings and Effects](#).

-  **Landscape**

For vivid blues and greens, and very sharp and crisp images. Effective for impressive landscapes.

-  **Fine Detail**

For detailed rendering of fine subject contours and subtle textures. The colors will be slightly vivid.

-  **Neutral**

For retouching later on a computer. Makes images subdued, with lower contrast and natural color tones.

-  **Faithful**

For retouching later on a computer. Faithfully reproduces the actual colors of subjects as measured in daylight with a color temperature of 5200K. Makes images subdued, with lower contrast.

-  **Monochrome**

Creates black-and-white images.

 **Caution**

- Color images cannot be recovered from JPEG/HEIF images shot with the **[Monochrome]** Picture Style.

-  **User Def. 1–3**

You can add a new style based on presets such as **[Portrait]** or **[Landscape]** or a Picture Style file, then adjust it as needed (). Shots taken with a style you have not customized yet will have the same characteristics as the default **[Auto]** setting.

Symbols

Icons on the Picture Style selection screen represent [Strength], [Fineness], and [Threshold] for [Sharpness] as well as [Contrast] and other parameters. The numbers indicate the values for these settings specified for the respective Picture Style.

Picture Style	(S, F, T, C, S, C)	Picture Style	(S, F, T, C, S, C)
Auto	4, 2, 3, 0, 0, 0	Neutral	0, 2, 2, 0, 0, 0
Standard	4, 2, 3, 0, 0, 0	Faithful	0, 2, 2, 0, 0, 0
Portrait	3, 2, 4, 0, 0, 0	Monochrome	4, 2, 3, 0, N, N
Landscape	5, 2, 3, 0, 0, 0	User Def. 1	Auto
Fine Detail	4, 1, 1, 0, 0, 0	User Def. 2	Auto
Neutral	0, 2, 2, 0, 0, 0	User Def. 3	Auto

INFO Detail set. SET OK

①	Sharpness	(S)	Strength
		(F)	Fineness
		(T)	Threshold
②	Contrast		
③	Saturation		
④	Color tone		
⑤	Filter effect (Monochrome)		
⑥	Toning effect (Monochrome)		

⚠ Caution

- For movie recording, "*" is indicated for the [Fineness] and [Threshold] parameters of [Sharpness]. [Fineness] and [Threshold] cannot be set for movie recording.

☑ [Settings and Effects](#)

☑  [Monochrome Adjustment](#)

You can customize any Picture Style by changing it from the default settings. For details on customizing **[Monochrome]**, see [Monochrome Adjustment](#).

1. Select : Picture Style.

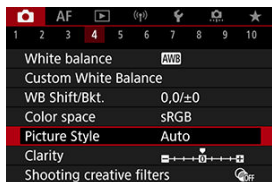

2. Select a Picture Style.



- Select the Picture Style to adjust, then press the <  > button.

3. Select an option.



- Select an option, then press the button.
- For details on settings and effects, see [Settings and Effects](#).

4. Set the effect level.



- Adjust the effect level, then press the button.



- Press the **MENU** button to save the adjusted setting and return to the Picture Style selection screen.
- Any settings you change from default values are displayed in blue.

Note

- For movie recording, [Fineness] and [Threshold] for [Sharpness] cannot be set (not displayed).
- By selecting [Default set.] in step 3, you can restore the parameter settings of the respective Picture Style to the defaults.
- To shoot with the Picture Style you adjusted, first select the adjusted Picture Style, then shoot.

Settings and Effects

	Sharpness			
		Strength	0: Weak outline emphasis	7: Strong outline emphasis
		Fineness ^{*1}	1: Fine	5: Grainy
		Threshold ^{*2}	1: Low	5: High
	Contrast	-4: Low contrast	+4: High contrast	
	Saturation	-4: Low saturation	+4: High saturation	
	Color tone	-4: Reddish skin tone	+4: Yellowish skin tone	

* 1: Indicates the edge thinness that enhancement applies to. The smaller the number, the finer the outlines that can be emphasized.

* 2: Contrast threshold between edges and surrounding image areas, which determines edge enhancement. The smaller the number, the more the outline will be emphasized when the contrast difference is low. However, noise tends to be more noticeable when the number is smaller.

Filter effect

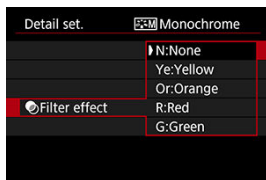

With a filter effect applied to a monochrome image, you can make white clouds or green trees stand out more.

Filter	Sample Effects
N:None	Normal black-and-white image with no filter effects.
Ye:Yellow	Blue sky will look more natural, and white clouds will look crisper.
Or:Orange	The blue sky will look slightly darker. The sunset will look more brilliant.
R:Red	The blue sky will look quite dark. Fall leaves will look crisper and brighter.
G:Green	Skin tones and lips will appear muted. Green tree leaves will look crisper and brighter.

Note

- Increasing **[Contrast]** will make the filter effect more pronounced.

Toning effect

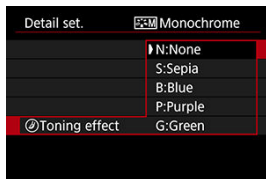

By applying a toning effect, you can create a monochrome image in the selected color. Effective when you want to create memorable images.

You can select a base Picture Style such as **[Portrait]** or **[Landscape]**, adjust it as desired, and register it under **[User Def. 1]** – **[User Def. 3]**. Useful when creating several Picture Styles with different settings.

Picture Styles that you have registered on the camera using EOS Utility (EOS software, [🔗](#)) can also be modified here.

1. Select **[Picture Style]**.

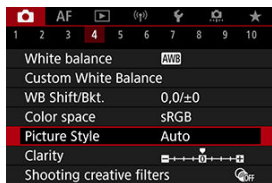

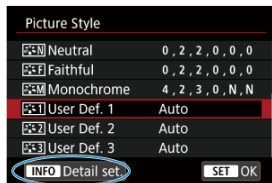

2. Select **[User Def.]**.

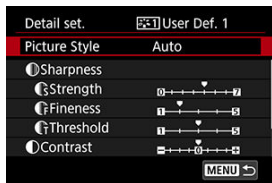

- Select **[User Def. *]**, then press the **<INFO>** button.

3. Press the  button.



- With [Picture Style] selected, press the  button.

4. Select a base Picture Style.

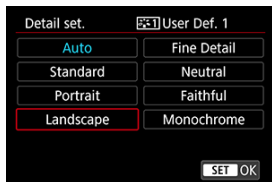

- Select the base Picture Style, then press the  button.
- Also select styles this way when adjusting styles registered to the camera with EOS Utility (EOS software).

5. Select an option.

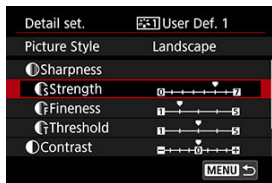

- Select an option, then press the  button.

6. Set the effect level.

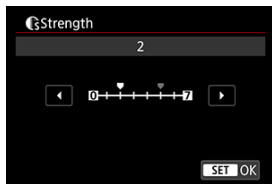

- Adjust the effect level, then press the  button.
- For details, see [Picture Style Customization](#).

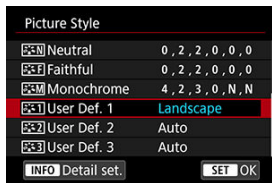

- Press the < MENU > button to save the adjusted setting and return to the Picture Style selection screen.
- The base Picture Style will be indicated on the right of [User Def. *].
- Blue style names in [User Def. *] have been changed from default values.

Caution

- If a Picture Style is already registered under [User Def. *], changing the base Picture Style will clear the parameter settings of the previously registered User Defined Picture Style.
- You can restore the default [User Def. *] style and settings by selecting [Basic settings] in : Reset camera].

Note

- To shoot with a registered Picture Style, select the registered [User Def. *], then shoot.
- For instructions on registering a Picture Style file to the camera, refer to the EOS Utility Instruction Manual.

You can adjust image clarity, as determined by the contrast of image edges. Set toward the negative end to make images look softer or toward the positive end for a sharper appearance.

1. Select [Clarity].

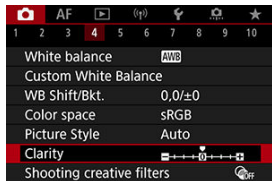

2. Set the effect level.

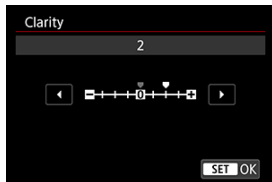

! Caution

- Setting clarity may darken or lighten the areas around boundaries in high-contrast images.
- The effect of this setting is not shown in images on the screen in still photo shooting.

☑ [Configuring Shooting Creative Filters](#)

☑ [Characteristics of Shooting Creative Filters](#)



You can shoot with filter effects applied. Note that only images with the filter effects applied are saved.

Configuring Shooting Creative Filters

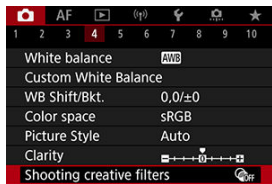
1. Select [: Shooting creative filters].





Caution

- The camera shoots in single shooting mode when a Creative filter is set, regardless of the drive mode setting (<  >, <  >, or <  >).

2. Select a filter effect.





- Turn the <  > dial to select a filter effect ().
- Images are shown with the filter effect applied.

Caution

- Some items on the AF tab are not available with **[Fish-eye effect]** or **[Miniature effect]** selected.

3. Adjust the filter effect.



- Press the < **INFO** > button.
- Turn the <  > dial to adjust the filter effect ().

4. Take the picture.







- The images captured have the filter effect applied.



Note

- Different creative filter effects are available in movie recording ([🔗](#)).

Characteristics of Shooting Creative Filters

-  **Grainy B/W**
Makes the image grainy and black and white. By adjusting the contrast, you can change the black-and-white effect.
-  **Soft focus**
Gives the image a soft look. By adjusting the blur, you can change the degree of softness.
-  **Fish-eye effect**
Gives the effect of a fish-eye lens. The image will have barrel distortion. Depending on the level of this filter effect, the area trimmed along the periphery of the image changes. Also, because this filter effect magnifies the center of the image, the apparent resolution at the center may degrade depending on the number of recorded pixels, so set the filter effect while checking the resulting image.
[AF area] is set to [1-point AF].
-  **Art bold effect**
Makes the photo look like an oil painting and the subject look more three-dimensional. By adjusting the effect, you can change the contrast and saturation. Note that subjects such as the sky or white walls may not be rendered with a smooth gradation and may look irregular or have significant noise.
-  **Water painting effect**
Makes the photo look like a watercolor painting with soft colors. By adjusting the effect, you can change the color density. Note that night scenes or dark scenes may not be rendered with a smooth gradation and may look irregular or have significant noise.
-  **Toy camera effect**
Shifts colors to those typical of toy cameras and darkens the four corners of the image. Color tone options can be used to change the color cast.
-  **Miniature effect**
Creates a diorama effect.
Shooting under the default setting will keep the center looking sharp.
To move the area that looks sharp (the scene frame), see "Adjusting the Miniature Effect" (🔗).
[AF area] is set to [1-point AF]. Shooting with the AF point and scene frame aligned is recommended.

 **Caution**

- With [**Grainy B/W**], the grainy preview will differ somewhat from the appearance of your shots.
- With [**Soft focus**] or [**Miniature effect**] options, the blurred effect preview may differ somewhat from the appearance of your shots.
- No histogram is displayed.
- A magnified view is not available.

- ☑ [Peripheral Illumination Correction](#)
- ☑ [Distortion Correction](#)
- ☑ [Digital Lens Optimizer](#)
- ☑ [Chromatic Aberration Correction](#)
- ☑ [Diffraction Correction](#)

Vignetting, image distortion, and other issues may be caused by lens optical characteristics. The camera can compensate for these phenomena by using **[Lens aberration correction]**.

1. Select [📷: Lens aberration correction].

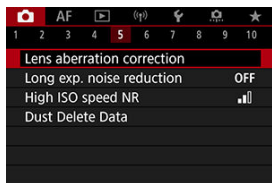

2. Select an option.

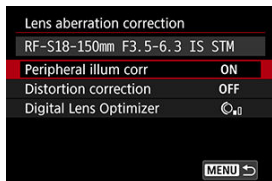

3. Select a setting.

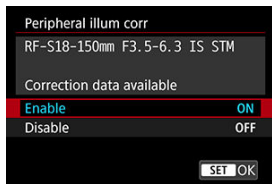

- Confirm that the name of the attached lens and [**Correction data available**] are displayed.
- If [**Correction data not available**] or [] is displayed, see [Digital Lens Optimizer](#).

Peripheral Illumination Correction

Vignetting (dark image corners) can be corrected.

Caution

- Depending on shooting conditions, noise may appear on the image periphery.
- The higher the ISO speed, the lower the amount of correction will be.

Note

- The amount of correction applied will be lower than the maximum correction amount applied with Digital Photo Professional (EOS software).

Distortion Correction

Distortion (image warping) can be corrected.



Caution

- Specifying distortion correction may subtly change the angle of view, resulting in images that are cropped a little and seem slightly less sharp.
- The amount of image cropped may vary between still photos and movies.



Note

- With RF lenses, distortion correction during movie recording is supported.

Digital Lens Optimizer

Various aberrations from lens optical characteristics can be corrected, along with diffraction and low-pass filter-induced loss of resolution.

If **[Correction data not available]** or  is displayed by **[Digital Lens Optimizer]**, you can use EOS Utility to add the lens correction data to the camera. For details, refer to the EOS Utility Instruction Manual.

Caution

- Image processing after you shoot takes longer when set to **[High]** (which causes the access lamp to be illuminated longer).
- Maximum burst is lower with **[High]**. Image recording to the card also takes longer.
- Depending on shooting conditions, noise may be intensified together with the effects of correction. Image edges may also be emphasized. Adjust Picture Style sharpness or set **[Digital Lens Optimizer]** to **[Disable]** as needed before shooting.
- The higher the ISO speed, the lower the amount of correction will be.
- For movie recording, **[Digital Lens Optimizer]** will not appear. (Correction is not possible.)
- The effect of Digital Lens Optimizer cannot be checked on the screen at the time of shooting.

Note

- With **[Digital Lens Optimizer]** set to **[Standard]** or **[High]**, **[Chromatic aberr corr]** and **[Diffraction correction]** are not displayed, but they are both set to **[Enable]** for shooting.

Chromatic Aberration Correction

Chromatic aberration (color fringing around subjects) can be corrected.



Note

- [Chromatic aberr corr] is not displayed when [Digital Lens Optimizer] is set to [Standard] or [High].

Diffraction Correction

Diffraction (loss of sharpness caused by the aperture) can be corrected.

⚠ Caution

- Depending on shooting conditions, noise may be intensified together with the effects of correction.
- The higher the ISO speed, the lower the amount of correction will be.
- For movie recording, **[Diffraction correction]** will not appear. (Correction is not possible.)
- The effect of diffraction correction cannot be checked on the screen at the time of shooting.

📄 Note

- "Diffraction correction" corrects degraded resolution not only from diffraction but also from the low-pass filter and other factors. Thus, correction is also effective for exposures with the aperture wide open.
- **[Diffraction correction]** is not displayed when **[Digital Lens Optimizer]** is set to **[Standard]** or **[High]**.

⚠ Caution

General precautions for lens aberration correction

- Lens aberration correction cannot be applied to existing JPEG/HEIF images.
- When using a non-Canon lens, setting the corrections to **[Disable]** is recommended even if **[Correction data available]** is displayed.
- Magnifying the periphery of the image may display parts of the image that will not be recorded.
- The amount of correction (except diffraction correction) is less for lenses that do not provide distance information.



Note

General notes for lens aberration correction

- Effects of lens aberration correction vary by lens and shooting conditions. Also, the effect may be difficult to discern depending on the lens used, shooting conditions, etc.
- If the correction is difficult to discern, magnifying and checking the image after shooting is recommended.
- Corrections are applied even when an extender or life-size converter is attached.
- If the correction data for the attached lens is not registered to the camera, the result will be the same as when the correction is set to **[Disable]** (except for diffraction correction).
- If necessary, refer to the EOS Utility Instruction Manual as well.

Noise such as dots of light or banding that tends to occur in long exposures at shutter speeds of one sec. or slower can be reduced.

1. Select [**5**]: Long exp. noise reduction].

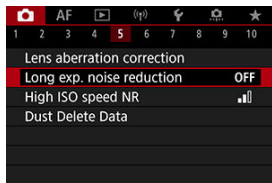

2. Set a reduction option.

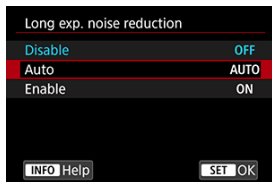

- **Auto**
For images exposed for 1 sec. or longer, noise reduction is performed automatically if noise typical of long exposures is detected. This setting is effective enough in most cases.
- **Enable**
Noise reduction is performed for all images exposed for 1 sec. or longer. The [**Enable**] setting may reduce noise that cannot be detected with the [**Auto**] setting.

 **Caution**

- With **[Auto]** or **[Enable]** set, noise reduction after you shoot may take as long as exposure for the shot.
- Images may look grainier with the **[Enable]** setting than with the **[Disable]** or **[Auto]** setting.
- **[BUSY]** is displayed as noise is reduced, and the shooting screen is not displayed until processing is finished, when you can shoot again.

You can reduce the image noise generated. This function is especially effective when shooting at high ISO speeds. When shooting at low ISO speeds, the noise in the darker parts of the image (shadow areas) can further be reduced.

1. Select [📷: High ISO speed NR].

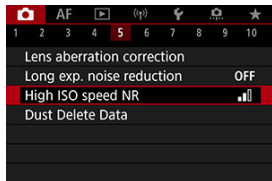

2. Set the level.



- **Low, Standard, High**

The camera applies an amount of noise reduction corresponding to your specified level.

- **Multi Shot Noise Reduction**

Applies noise reduction with higher image quality than [High]. For a single photo, four shots are taken continuously and aligned and merged automatically into a single JPEG image.

Note that [Multi Shot Noise Reduction] is not available with image quality set to RAW or RAW+JPEG.

Precautions on Multi Shot Noise Reduction

- If there is significant misalignment in the image due to camera shake, the noise reduction effect may become smaller.
- Be careful about camera shake in handheld shots. Using a tripod is recommended.
- If you shoot a moving subject, the moving subject may leave afterimages.
- Auto image alignment may not function properly with repetitive patterns (lattice, stripes, etc.) or flat, single-tone images.
- If the subject's brightness changes as the four consecutive shots are taken, irregular exposure in the image may result.
- After shooting, it may take some time to record an image to the card after performing noise reduction and merging the images. "BUSY" is displayed as images are processed, and shooting is not possible until processing is finished.
- **[Multi Shot Noise Reduction]** is not available with any of these features: bulb exposures, AEB or WB bracketing, RAW or RAW+JPEG, long exposure noise reduction, multiple exposures, HDR mode or HDR PQ settings, focus bracketing, Creative filter shooting, or RAW burst mode.
- Flash photography is not available. Note that the AF-assist beam of Speedlites may be fired, depending on the **[AF: AF-assist beam firing]** setting.
- **[Multi Shot Noise Reduction]** is not available (not displayed) when recording movies.
- The camera automatically switches to **[Standard]** when RAW or RAW+JPEG image quality is set.
- The camera automatically switches to **[Standard]** if you set the power switch to < **OFF** >, replace the battery or card, or switch to < **B** > mode or movie recording.

☑ [Preparation](#)

☑ [Dust Delete Data Appending](#)

Dust Delete Data used to erase dust spots can be appended to images in case sensor cleaning leaves dust on the sensor. The Dust Delete Data is used by Digital Photo Professional (EOS software) to erase the dust spots automatically.

Preparation

- Use an RF or EF lens.
- Prepare a solid white object such as a sheet of paper.
- Set the lens focal length to 50 mm or longer.
- Set the focus mode to MF (∞) and focus manually at infinity (∞). If the lens has no distance scale, rotate the camera to face toward you and turn the focusing ring clockwise all the way.

1. Select [Dust Delete Data].

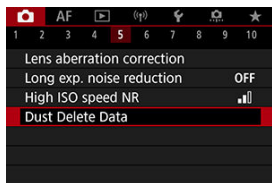

2. Select [OK].

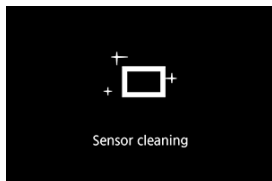
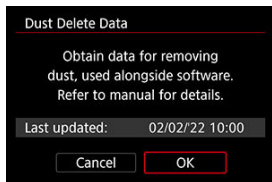

- After the automatic self-cleaning of the sensor is performed, a message will appear. Although there will be a mechanical sound of the shutter during the cleaning, no picture is taken.

3. Shoot a plain white object.

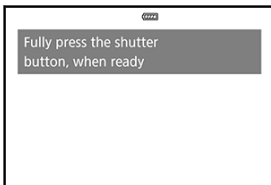

- Shoot with a plain white object (such as a new sheet of white paper) filling the screen, at a distance of 20–30 cm (0.7–1.0 ft.).
- Since the image will not be saved, the data can still be obtained even if there is no card in the camera.

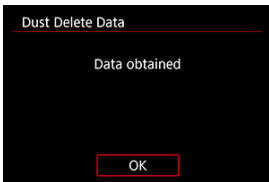

- When the picture is taken, the camera will start collecting the Dust Delete Data. When the Dust Delete Data is obtained, a message will appear.
- If the data is not obtained successfully, an error message will appear. Check the information in [Preparation](#), select **[OK]**, and shoot again.

Dust Delete Data Appending

The camera will append the Dust Delete Data obtained to all shots from now on. Acquiring Dust Delete Data immediately before shooting is recommended.

For details about using Digital Photo Professional (EOS software) to erase dust spots automatically, refer to the Digital Photo Professional Instruction Manual.

File size is essentially unaffected by Dust Delete Data appended to images.



Caution

- Dust Delete Data is not obtained when EF-S lenses are used.
- Dust Delete Data is not added to images when [**Distortion correction**] is set to [**Enable**].
- If the object has any pattern or design, it may be recognized as dust data and affect the accuracy of the dust deletion with the Digital Photo Professional (EOS software).

☑ [Merging Multiple Exposures with a JPEG Image Recorded on the Card](#)

☑ [Checking and Deleting Multiple Exposures During Shooting](#)

As you shoot multiple exposures (2–9), you can see how the images will be merged into a single image.

1. Select [**Ⓜ**: Multiple exposure].

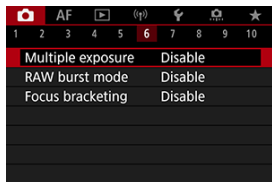

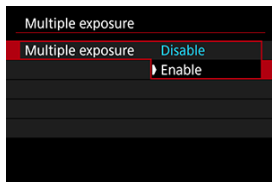

2. Set [Multiple exposure].

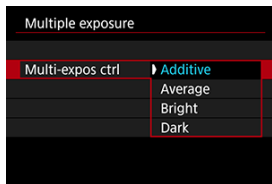

- Select [**E**nable].

3. Set [Multi-expos ctrl].



- Select a merging option, then press the <  > button.

- **Additive**

The exposure of each single image captured is added cumulatively. Based on [**No. of exposures**], set negative exposure compensation. Follow these basic guidelines to set the exposure compensation amount.

Exposure compensation setting guidelines, by number of exposures

Two exposures: -1 stop, three exposures: -1.5 stops, four exposures: -2 stops

- **Average**

Based on the [**No. of exposures**], negative exposure compensation is set automatically as you shoot multiple exposures. If you shoot multiple exposures of the same scene, the exposure of the subject's background will be automatically controlled to obtain the standard exposure.

- **Bright/Dark**

Brightness (or darkness) of the base image and added images is compared at the same position, and bright (or dark) portions are retained. Some overlapping colors may be mixed, depending on the relative brightness (or darkness) of the images.

4. Set [No. of exposures].



- Select the number of exposures, then press the <  > button.

5. Set [Continue Mult-exp].

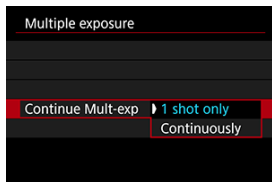

- Select an option, then press the <  > button.
- With [**1 shot only**], multiple-exposure shooting will be canceled automatically after the shooting ends.
- With [**Continuously**], multiple-exposure shooting continues until the setting in step 2 is set to [**Disable**].

6. Shoot the first exposure.



- The captured image is displayed.
- The [INFO] icon blinks.
- The number of remaining exposures is indicated on the screen (1) for reference.
- Pressing the < [INFO] > button enables you to view the captured image (✔).





7. Shoot the next exposures.

- Images captured so far are displayed merged. For only image display, press the < INFO > button repeatedly.
- Multiple-exposure shooting will end when the set number of exposures are taken.

Note

- As shooting information, the multiple-exposure image has information captured for the last shot.

 Caution

- Image noise, color shift, or banding may be noticeable in multiple exposures, depending on subjects and shooting conditions.
- With multiple exposures, the more exposures there are, the more noticeable the noise, irregular colors, and banding will be.
- Multiple-exposure shooting is canceled if you set the power switch to < OFF > or switch batteries or cards.
- Multiple-exposure shooting ends if you switch to a Basic Zone mode or to <  >, <  >, <  >, or <  > mode.
- If you connect the camera to a computer, multiple-exposure shooting will not be possible. If you connect the camera to a computer during shooting, multiple-exposure shooting will end.



Merging Multiple Exposures with a JPEG Image Recorded on the Card

You can select a JPEG image recorded on the card as the first single exposure. The selected JPEG image will remain intact.

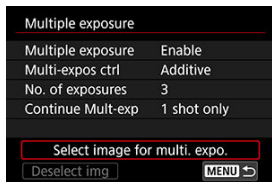
1. Select [Select image for multi. expo.].



2. Select the first image.

- Turn the <  > dial to select the first image, then press the <  > button.
- Select [OK].
- The file number of the selected image will be displayed at the bottom of the screen.

3. Take the picture.

- When you select the first image, the number of remaining exposures as set with **[No. of exposures]** will decrease by 1.

Caution

- The following images cannot be selected.
 - RAW or HEIF images
 - JPEG images in **M / S1 / S2** sizes
 - Images from other cameras
- Images that cannot be merged may be displayed.

Note



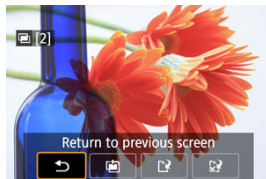

- You can also select a JPEG image used in multiple-exposure shooting.
- Select **[Deselect img]** to cancel image selection.
- The color space set for the first image also applies to subsequent images.

Checking and Deleting Multiple Exposures During Shooting



Before you finish shooting your specified number of exposures, you can press the <  > button to view the multiple-exposure image so far, check exposure, and see how the images will be merged.

Pressing the <  > button will display the operations possible during multiple-exposure shooting.

Option	Description
 Return to previous screen	The screen before you pressed the <  > button will reappear.
 Undo last image	Deletes the last image you shot (enabling you to replace it by shooting again). The number of remaining exposures will increase by 1.
 Save and exit	Saves shots up to that point as a multiple-exposure image and exits multiple-exposure shooting.
 Exit without saving	Exits the multiple-exposure shooting without saving the image.

Caution

- During multiple-exposure shooting, you can only play back multiple-exposure images.

? FAQ

- **Are there any restrictions on the image quality?**

Multiple exposures are captured as JPEG [📷] images. Even with [📷: Image quality] set to RAW only, they are captured as JPEG [📷] images.

- **Can I merge images recorded on the card?**

With [Select image for multi. expo.], you can select the first single exposure from the images recorded on the card (🔗). Note that you cannot merge multiple images already recorded on the card.

- **Will auto power off take effect during multiple-exposure shooting?**

During multiple-exposure shooting, auto power off will not take effect. Note that before you start multiple-exposure shooting, auto power off automatically takes effect at the time set in the [Auto power off] option of [🔋: Power saving], which will cancel multiple-exposure shooting.

Enables fast continuous shooting of RAW images. Useful for choosing the best shot, taken at exactly the right moment, from your captured images. Shots are captured as a single file (roll) with multiple images.

You can extract any image from the roll to save it separately (📄).

1. Select [📷: RAW burst mode].

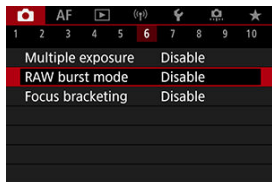

2. Set [RAW burst mode].

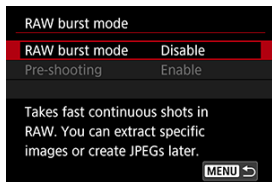

3. Select [Enable].

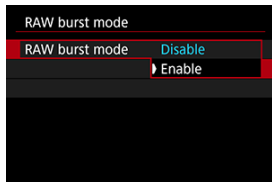

- After you select [Enable], [RAW] is displayed when you shoot.

4. Select [Pre-shooting].

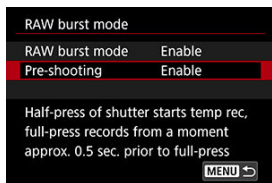

5. Set an option.

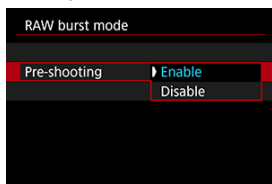



- **[Enable]:** Shooting begins slightly before (up to approx. 0.5 sec. before) you press the shutter button completely, after you momentarily press it halfway. [C_{ON}] is displayed when you shoot.
- **[Disable]:** Shooting begins when you press the shutter button completely. [C_{OFF}] is displayed when you shoot.

6. Shoot.



- An on-screen indicator shows buffer status. The color varies by status. The indicator is green during shooting, red if recording is not possible because the buffer is full, and white otherwise.
- Pressing the shutter button completely shoots continuously until the buffer is full or you release the button.

Caution

- Use cards with 4 GB or more of free space.
- Images may not be captured correctly if the battery runs out during image processing while you are shooting in RAW burst mode with a slow-writing card and low battery.
- Display pauses when you press the shutter button halfway.
- Camera shake or subject motion may cause image distortion.
- ISO Auto is used when shooting in < **P** >, < **Tv** >, or < **Av** > mode.
- Shutter speeds slower than 1/30 sec. are not available in < **Tv** >, < **M** >, or < **Fv** > mode.
- Approx. 32.3 megapixels (6960×4640) are used in shooting.
- Images are captured using the electronic shutter. Before shooting, consider checking the [Electronic] precautions ()
- To view images in rolls on a computer, either extract them or use the EOS application Digital Photo Professional.
- Set [: **RAW burst mode**] to [Disable] if you will connect the camera to a computer and use the EOS application EOS Utility. Setting it to [Enable] will prevent the camera from communicating with the computer.
- Maximum burst may be lower under low light.
- In RAW burst mode, the aperture value will change if you zoom while pressing the shutter button halfway or completely with zoom lenses that have variable maximum aperture. To maintain the same exposure in < **M** > mode, consider shooting with ISO Auto.
- In RAW burst mode, even with zoom lenses that do not have variable maximum aperture, exposure may change if you zoom while pressing the shutter button halfway or completely. For details, refer to the Canon website ()
- There may be a delay before subsequent shooting in RAW burst mode is possible, depending on shooting conditions, the type of memory card, and the number of shots taken continuously. Writing will finish faster on cards with a fast write speed.

Note

- RAW images captured are saved in a single file (roll). These files have a .CR3 file extension.
- Picture Style, white balance, and Auto Lighting Optimizer settings configured for the first shot also apply to the next shots.
- The camera does not beep as you are shooting.
- [: **RAW burst mode**] reverts to [Disable] when the power switch is set to < **OFF** >.

Focus bracketing enables continuous shooting with the focal distance changed automatically after each shot. These images enable you to create a single image in focus over a deep depth of field. Compositing is also possible using an application that supports depth compositing, such as Digital Photo Professional (EOS software).

1. Select [Focus bracketing].

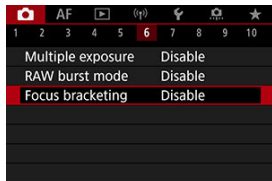

2. Set [Focus bracketing].

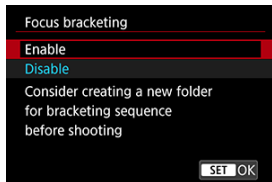

- Select [Enable].

3. Set [Number of shots].



- Specify the number of images captured per shot.
- Can be set in a range of [2]–[999].

4. Set [Focus increment].

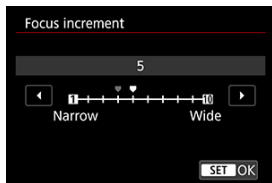

- Specify how much to shift the focus. This amount is automatically adjusted to suit the aperture value at the time of shooting. Larger aperture values increase the focus shift and make focus bracketing cover a wider range under the same focus increment and number of shots.
- After completing the settings, press the <  > button.

5. Set [Exposure smoothing].

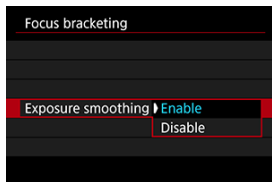

- You can compensate for changes in image brightness during focus bracketing by selecting **[Enable]**, so that the camera makes adjustments based on differences between the displayed and actual aperture value (effective f/number), which varies by focal position.
- Select **[Disable]** if you prefer not to compensate for changes in image brightness during focus bracketing. Use this option for purposes other than depth compositing of the captured images in applications such as DPP.

6. Set [Depth composite].

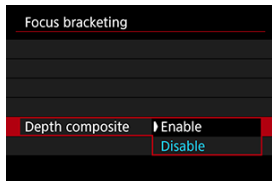

- Select **[Enable]** for in-camera depth compositing. Both the depth-composited image and the source images are saved.
- Select **[Disable]** if you prefer not to perform in-camera depth compositing. Only captured images are saved.

7. Set [Crop depth comp.].

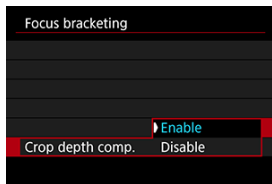



- Select [**Enable**] for cropping before compositing, to prepare any images without a sufficient angle of view for compositing alignment by cropping them to correct the angle of view.
- Select [**Disable**] if you prefer not to crop these images. In this case, areas without a sufficient angle of view are covered by a black border in the saved images. You can crop the images manually or edit them as needed.



8. Shoot.

- To save your shots in a new folder, tap [**+**] and select [**OK**].
- Focus at the nearer end of your preferred focal range, then press the shutter button completely.
- Once shooting begins, release the shutter button.
- The camera shoots continuously, shifting the focal position toward infinity.
- Shooting ends after your specified number of images, or at the far end of the focal range.
- To cancel shooting, press the shutter button completely again.

Caution

- Focus bracketing is intended for still photo shooting on a tripod.
- Shooting with a wider angle of view is recommended. After depth compositing, you can crop the image if necessary.
- For details on lenses compatible with this feature, visit the Canon website () .
- Suitable **[Focus increment]** settings vary by subject. An unsuitable **[Focus increment]** setting may cause unevenness in composite images, or shooting may take more time because more shots are taken. Take some test shots to decide a suitable **[Focus increment]** setting.
- Flash photography is not available.
- Shooting under flickering light may cause uneven images. In this case, lowering the shutter speed may give better results.
- Focus bracketing is not available when the camera is set to manual focus () .
- Canceling shooting in progress may cause exposure problems in the last image. Avoid using the last image when combining the images in Digital Photo Professional.
- Maximum shutter speed with focus bracketing is 1/8000 sec.
- Depth compositing is canceled if you open the battery compartment or card slot cover, or if the remaining battery capacity becomes too low. After cancellation, composited images are not saved.
- Depth compositing may fail for patterned images (with a lattice or stripes, for example) or images that are generally flat and uniform.
- When taking several shots, start by focusing closer, then gradually focus farther away.
- Too great a distance when moving the focal position between multiple shots may cause unevenness in depth-composited images, or it may cause compositing to fail.
- Depth compositing is intended for subjects that are not moving. For this reason, shooting subjects in motion may prevent effective compositing.
- Depth compositing of images with multiple subjects may fail if your shots are composed with the subjects far apart from each other, for example.
- To cancel depth compositing in progress, press the < INFO > button. Cancellation discards the composited image but keeps all source images.
- In depth compositing, optimal images from the shots are selected and combined by the camera. Not all of the shots are combined to create the composite image.

Note

- Using a tripod, remote switch (sold separately, ) , or wireless remote control (sold separately, ) is recommended.
- For best results, set the aperture value in a range of f/5.6–11 before shooting.
- Details such as shutter speed, aperture value, and ISO speed are determined by conditions for the first shot.
-  **Focus bracketing** reverts to **[Disable]** when the power switch is set to < OFF > .

Depth compositing image quality setting and images saved

- With [📷 Rec options] in [📷: Record func+card/folder sel.] set to an option other than [Rec. separately]













		Source Images* ¹	Composited Image
Image Quality	Only RAW (CRAW)	RAW	JPEG/HEIF* ²
	Only JPEG/HEIF* ³	JPEG/HEIF	JPEG/HEIF
	RAW (CRAW) + JPEG/HEIF* ³	RAW (CRAW) + JPEG/HEIF	JPEG/HEIF

- With [📷 Rec options] in [📷: Record func+card/folder sel.] set to [Rec. separately]

Image Quality	Slot 1	Slot 2	Source Images* ¹		Composited Image	
			Slot 1	Slot 2	Slot 1	Slot 2
		RAW (CRAW)		RAW (CRAW)		JPEG/HEIF* ²
	RAW (CRAW)	Only JPEG/HEIF* ³	RAW (CRAW)	JPEG/HEIF	JPEG/HEIF* ²	JPEG/HEIF
	Only JPEG/HEIF* ³	RAW (CRAW)	JPEG/HEIF	RAW (CRAW)	JPEG/HEIF	JPEG/HEIF* ²
	Only JPEG/HEIF* ³		JPEG/HEIF		JPEG/HEIF	

* 1 Multiple captured images

* 2 Image quality of composited images is  when set to RAW (CRAW).

* 3 /// image quality is not available. Settings are adjusted so that the resulting image is  for /// or  for /.

Note

- Composited images are saved as JPEG or HEIF images. RAW composited images are not produced.

Interval Timer Shooting

With the interval timer, you can set the shooting interval and number of shots, so that the camera takes individual shots repeatedly according to your interval until your specified number of shots are taken.

1. Select [Interval timer].

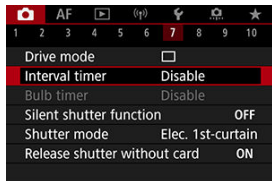

2. Select [Enable].

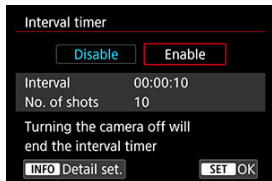

- Select [Enable], then press the <INFO> button.

3. Set the shooting interval and number of shots.

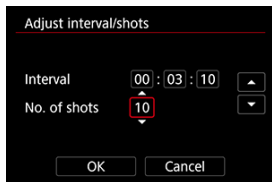

- Select an option to set (hours : minutes : seconds / number of shots).
- Press the < > button to display [].
- Set a value, then press the < > button. (Returns to [].)
- **Interval**
Can be set in a range of [00:00:01]–[99:59:59].
- **No. of shots**
Can be set in a range of [01]–[99]. To keep the interval timer on indefinitely until you stop it, set [00].

4. Select [OK].

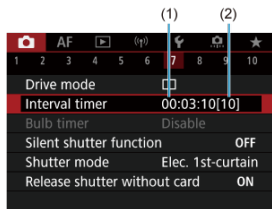

- The interval timer settings will be displayed on the menu screen.
(1) Interval
(2) Number of shots

5. Take the picture.

- First shot is taken and shooting continues according to the interval timer settings.
- During interval timer shooting, **[TIMER]** will blink.
- After the set number of shots are taken, the interval timer shooting will stop and be automatically canceled.



Note

- Using a tripod is recommended.
- Taking test shots in advance is recommended.
- Even during interval timer shooting, you can still shoot as usual by pressing the shutter button completely. Note that the camera will prepare for the next interval timer shot approx. 5 sec. in advance, which will temporarily prevent operations such as adjusting shooting settings, accessing menus, and playing back images.
- If the next scheduled interval timer shot is not possible because the camera is shooting or processing images, it will be skipped. For this reason, fewer shots than specified will be taken.
- Even during interval timer operation, auto power off is triggered after approx. 8 sec. of inactivity, as long as **[Auto power off]** under **[P: Power saving]** is not set to **[Disable]**.
- Can also be combined with AEB, white balance bracketing, multiple exposures, and HDR mode.
- To stop interval timer shooting, select **[Disable]** or set the power switch to **<OFF>**.

Caution

- Do not point the camera toward an intense light source, such as the sun or an intense artificial light source. Doing so may damage the image sensor or the camera's internal components.
- In < AF > focus mode, the camera will not shoot unless subjects are in focus. Consider setting the mode to manual focus and focusing manually before shooting.
- If the shooting time is long, using the household power outlet accessories (sold separately) is recommended.
- Shooting long exposures or using shutter speeds longer than the shooting interval will prevent shooting at the specified interval. For this reason, fewer shots than specified will be taken. Using shutter speeds nearly the same as the shooting interval may also reduce the number of shots.
- If the time it takes to record to the card exceeds the shooting interval due to the shooting functions set or card performance, some of the shots may not be taken with the set intervals.
- When using flash with interval timer shooting, set an interval longer than the flash charge time. Intervals that are too short may prevent the flash from firing.
- Intervals that are too short may prevent shooting or autofocus.
- Interval timer shooting is canceled and reset to **[Disable]** if you set the power switch to < OFF >, switch the shooting mode to < B >, < C1 >, < C2 >, or < C3 >, switch to movie recording, or use EOS Utility (EOS software).
- During interval timer shooting, you cannot use [Remote Control Shooting](#) or remote-release shooting with a Speedlite.

Disables shutter release sounds, operating sounds, and firing and illumination of the flash and other light sources.

The following settings are used and cannot be changed.

- Shutter mode: **[Electronic]**
- Shutter release sound, focused beep: only headphone output
- Touch sounds, self-timer sounds: silent
- Shutter at shutdown: open
- Long exposure noise reduction: **[Disable]**
- Flash firing: **[Disable]**
- AF-assist beam firing: **[Disable]**
- Self-timer lamp: not illuminated

When using lenses equipped with focus preset, consider turning off the focus preset beep.

1. Select [📷: Silent shutter function].

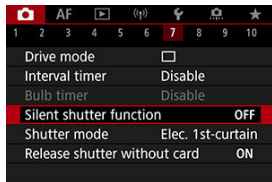

2. Select [On].

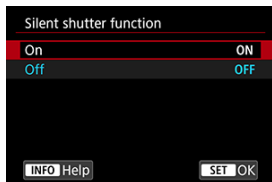

You can choose the method of shutter release.

1. Select [📷: Shutter mode].

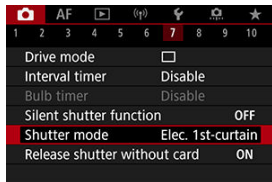

2. Select an option.

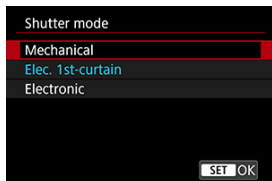

● Mechanical

Shooting activates the mechanical shutter. Recommended when shooting with the aperture of a bright lens wide open.

● Elec. 1st-curtain

Camera vibration blur may be reduced more than with the mechanical shutter, under some shooting conditions.

Flash sync shutter speed can be set higher than with the mechanical shutter.

● Electronic

Enables reduced sound and vibration from shutter operations, compared to mechanical shutter or electronic first-curtain.

Recommended when shooting with the aperture of a bright lens wide open.

Maximum shutter speed can be set higher than for mechanical shutter or electronic first-curtain.

- A white frame is displayed around the screen when [: **Drive mode**] is set to [] or [].
- Shutter operations are accompanied by beeps. You can disable beeping in [: **Beep**].

! Caution

- Defocused image areas may be incomplete when shooting near maximum aperture at high shutter speeds, depending on shooting conditions. If you dislike the appearance of defocused image areas, shooting as follows may give better results.
 - Shoot with an option other than [**Elec. 1st-curtain**].
 - Lower the shutter speed.
 - Increase the aperture value.
- Setting [: **Silent shutter function**] to [**On**] sets the shutter mode to [**Electronic**].
- Zooming during continuous shooting may cause changes in exposure even at the same *f*/number. For details, refer to the Canon website ([🌐](#)).
- Depending on the lens used, consider shooting with [**Elec. 1st-curtain**] or [**Electronic**] to ensure effective image stabilization. For details, refer to the lens instruction manual.

Precautions when set to [**Elec. 1st-curtain**]

- Camera vibration blur is more likely to occur with [] than with [] or [].

Precautions when set to [**Electronic**]

- The continuous shooting speed may become slower depending on the shooting conditions.
- Images of fast-moving subjects may look distorted.
- Images may lack suitable exposure if the aperture value changes in < **P** > (Program AE), < **Tv** > (Shutter-priority AE), or < **Fv** > (Flexible-priority AE) shooting.
- With some lenses and under some shooting conditions, lens focusing and aperture adjustment may be audible.
- Bands of light may be displayed and captured images may be affected by light and dark banding if you shoot with electronic shutter during flash firing by other cameras or under fluorescent lighting or other flickering light sources.
- Banding may appear in the viewfinder or on the screen if you shoot under flickering light sources.

Releasing Shutter without Card

You can set the camera not to shoot unless there is a card in the camera. The default setting is **[Enable]**.

1. Select [: Release shutter without card].

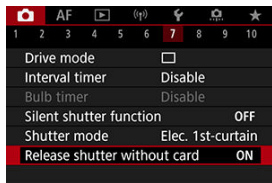

2. Select [Disable].

Image Stabilizer (IS Mode)

[Focal Length](#)

Image stabilization by the camera reduces camera shake in still photo shooting. Set [**IS mode**] to [**On**] as follows when using non-IS lenses. With IS-equipped lenses, camera shake is reduced using stabilization by both the camera and lens. When using IS lenses that do not have an IS switch, set [**IS mode**] to [**On**]. Note that the [**IS mode**] setting is not displayed when you are using IS lenses that have an IS switch. In that case, setting the lens IS switch to < **ON** > combines stabilization by the camera and lens.

1. Select [: IS (Image Stabilizer) mode].

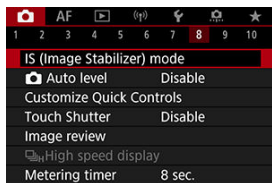

2. Select [**IS mode**].

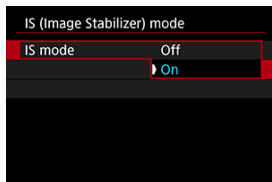

- Select [**On**].

3. Select [Still photo IS].



- **[Always]:** Provides constant image stabilization.
- **[Only for shot]:** Image stabilization is active only at the moment of shooting.

⚠ Caution

- In some cases, this may not provide sufficient stabilization for certain lenses.

📄 Note

- For details on image stabilization for movie recording, see [Movie Digital IS](#).

Focal Length

Image stabilization based on your specified lens focal length is possible by setting the focal length when using lenses that do not support lens communication.

1. Select [Focal length].

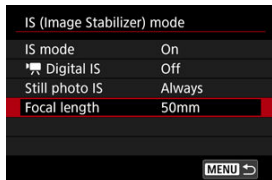

2. Set the focal length.

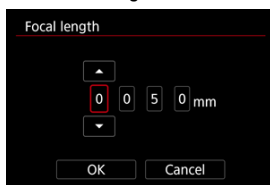

- Turn the < > dial to select the digit of the focal length.
- Press the < > button to display [].
- Set a value, then press the < > button. (Returns to [].)

3. Select [OK].

Caution

- Set [: **Release shutter w/o lens**] to [Enable]. [Disable] prevents image stabilization.
- [**Focal length**] is not displayed when lenses are attached that support lens communication.

Note

- Focal length can be set in a range of 1–1000 mm (in 1 mm increments).

Auto Level

Auto leveling helps keep images straight. This feature is also applied in vertical shooting.

1. Select [Auto level].



2. Select [Enable].

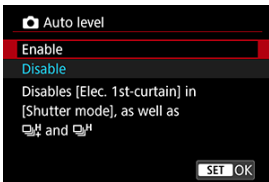

Caution

- Setting [Auto level] to [Enable] disables the following menu items. Check before shooting, because if they are currently set, they will be changed to another option.
 - [Shutter mode]: [Elec. 1st-curtain]
 - [Drive mode]: [] (High speed continuous +) and [] (High-speed continuous) (when [Shutter mode] set to [Mechanical])

[☑ Resetting the Custom Quick Control Screen or Clearing All Items](#)

Quick Control items and the layout are customizable.

1. Select [: Customize Quick Controls].

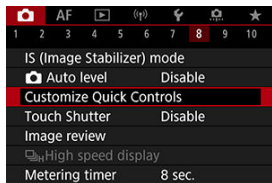

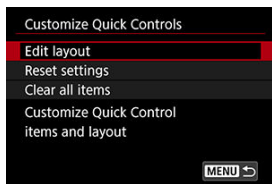

2. Select [Edit layout].





3. Select items to remove.



- Turn the <  > dial or use <  > to select an item to remove, then press the <  > button.
- Items shown on the Quick Control screen are labeled with a checkmark. Items without a checkmark will be removed.



4. Select items to add.





- Turn the <  > dial or use <  > to select an item to add, then press the <  > button.
- To change the layout, press the < **INFO** > button.

5. Change the layout.



- Use the <  > dial to select an item to move, then press the <  > button.



- Use the <  > dial to move the item, then press the <  > button.
- Press the < MENU > button to exit setup.

6. Select [Save and exit].

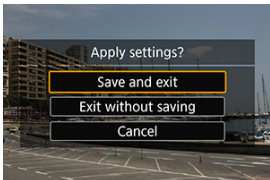



7. Review the screen.

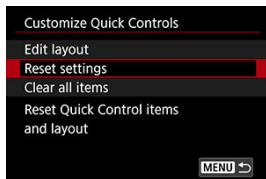

- Press the <  > button to check the screen with your settings applied.

Resetting the Custom Quick Control Screen or Clearing All Items



- Select [**Reset settings**] to restore the default Quick Control screen items and layout.
- Select [**Clear all items**] to remove all items from the layout, so that no Quick Control screen is displayed when the <  > button is pressed.

Shooting with the Touch Shutter

Just by tapping the screen, you can focus and take the picture automatically.

1. Enable the Touch Shutter.

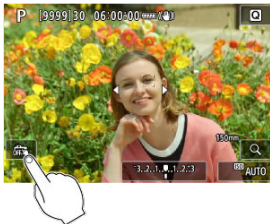

- Tap [📷] on the screen.
- Each time you tap the icon, it will toggle between [📷] and [📷].
- [📷] (Touch Shutter: Enable)
The camera will focus on the spot you tap, then the picture will be taken.
- [📷] (Touch Shutter: Disable)
You can tap a spot to perform focusing on the spot. Press the shutter button completely to take the picture.

2. Tap the screen to shoot.

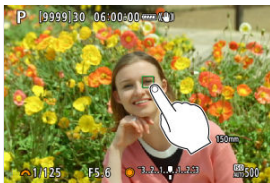

- Tap the face or subject on the screen.
- On the point you tap, the camera focuses (Touch AF) using your specified [AF Area](#).
- When [C] is set, the AF point turns green when focus is achieved, then the picture is taken automatically.
- If focus is not achieved, the AF point turns orange and the picture cannot be taken. Tap the face or subject on the screen again.

! Caution

- The camera shoots in single shooting mode regardless of the drive mode setting ([C], [H], or [R]).
- Tapping the screen focuses with [One-Shot AF], even if [AF: AF operation] is set to [Servo AF].
- Tapping the screen in magnified view will not focus or take the picture.
- When shooting by tapping with [Review duration] in [Image review] set to [Hold], you can take the next shot by pressing the shutter button halfway or tapping [Return].

📱 Note

- To shoot with bulb exposure, tap the screen twice. Tap once to start exposure and again to stop it. Be careful not to shake the camera when tapping the screen.

Image Review

[Review Duration](#)

[Viewfinder Display](#)

Review Duration

To keep the image displayed immediately after you shoot, set to **[Hold]**, and if you prefer not to have the image displayed, set to **[Off]**.

1. Select **[: Image review]**.

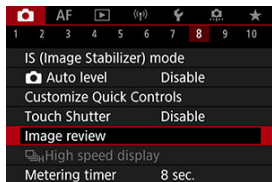

2. Select **[Review duration]**.

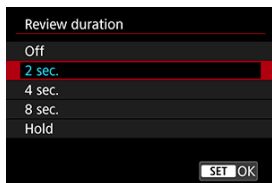

3. Set a time option.



Note

- When **[Hold]** is set, images are displayed as long as the time set in the **[Screen off]** option of **[🔋: Power saving]**.

Viewfinder Display

Set to **[Enable]** for viewfinder display of your shots immediately after you shoot.

1. Select **[Image review]**.

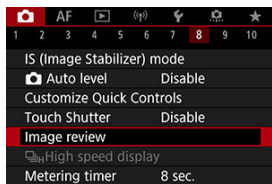

2. Select **[Viewfinder display]**.

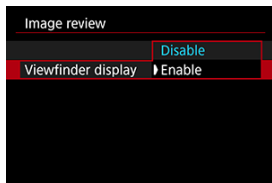

3. Select an option.

Note

- **[Viewfinder display]** settings take effect when **[Review duration]** is set to an option other than **[Off]**.

High-speed display that switches between each shot and the live image is available when shooting in [H] (high-speed continuous shooting) drive mode and in a shutter mode other than electronic shutter.

1. Select [H]: [H] High speed display.

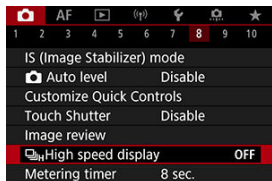



2. Select an option.



- Select [Enable] for display that switches between each shot and the live image.

 **Caution**

- Images may waver or flicker during high-speed display. This occurs more often at high shutter speeds. However, this does not affect shooting results.
- High-speed display is not performed for shutter speeds slower than 1/30 sec., aperture values higher than $f/11$, conditions that make autofocus difficult, flash photography, or high ISO expansion. It may also stop as you are shooting.
- High-speed display is not available in the following cases.
 - With [: **OVF sim. view assist**] set to [**On**]
 - With [: **Display simulation**] set to [**Disable**] or [**Exposure only during**  **DOF**]

You can set how long the metering timer runs (which determines the duration of exposure value display/AE lock) after it is triggered by an action such as pressing the shutter button halfway.

1. Select [📷: Metering timer].
2. Set a time option.

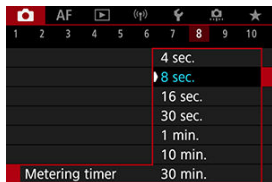

With display simulation, display of image brightness and depth of field more closely matches the actual brightness (exposure) of your shots.

1. Select [📷: Display simulation].

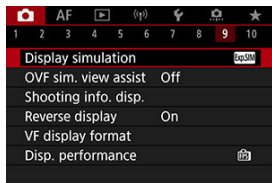

2. Select an option.

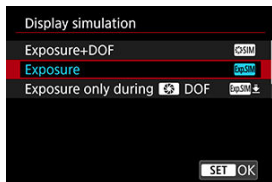



- **Exposure+DOF** (Exp.SIM)
Image brightness and depth of field as displayed closely matches the actual brightness (exposure) of your shots. If you set exposure compensation, the image brightness will change accordingly. Similarly, changes to the aperture value will alter the depth of field.
- **Exposure** (Exp.SIM)
Image brightness as displayed closely matches the actual brightness (exposure) of your shots. If you set exposure compensation, the image brightness will change accordingly.
- **Exposure only during** [📷] **DOF** (Exp.SIM) [⬇️]
Normally, the image is displayed at standard brightness, so it is easy to see. Only when you press and hold the depth-of-field preview button will image brightness resemble actual brightness (exposure) of your shot, and you can check depth of field.

- **Disable (OFF)**

The image is displayed at standard brightness, so it is easy to see. Even if you set exposure compensation, the image is displayed at the standard brightness.

 **Caution**

Notes on [Exposure+DOF]

- Display may flicker at some shutter speeds.
- With EF lenses, this setting may increase the shutter-release time lag.
- The depth of field shown is only a guideline. For more precise indication of the depth of field, press the depth-of-field preview button.
- [Exposure+DOF] is not available with some lenses.
-  SIM blinks if either exposure or depth of field cannot be simulated, or if neither can be simulated.
-  SIM is dimmed if either exposure or depth of field simulation stops, or if both simulations stop.

Notes on [Disable]

- In some drive modes, simulated images may be displayed during continuous shooting.

Natural-looking viewfinder and screen display, resembling the view from an optical viewfinder, is available in still photo shooting. Note that images displayed with this feature set to **[On]** may differ from actual shooting results.

1. Select **[: OVF sim. view assist]**.

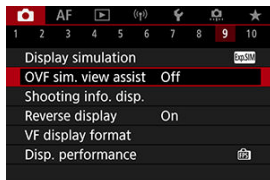

2. Select an option.

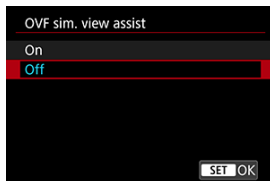

 **Caution**

- Setting this feature to **[On]** sets **[📷: Display simulation]** to **[Disable]**.
- Optical viewfinder simulation is used for display when this feature is set to **[On]** in HDR shooting.
- Creative filter display is used when shooting with Creative filters, even if this feature set to **[On]**.
- Image brightness before and after One-Shot AF is more likely to change when set to **[On]** than when set to **[Off]**.
- Optical viewfinder simulation is not used during display to external monitors, including in display to both an external monitor and the camera screen.
- Depending on setting screens, optical viewfinder simulation may not be used for display.
- Display may not resemble an optical viewfinder in some cases.
- The display appearance may change during continuous shooting, with some combinations of drive and shutter modes.

 **Note**

- Not available for multiple exposures or in RAW burst mode.

Shooting Information Display

- [Customizing Information on the Screen](#)
- [Customizing Information in the Viewfinder](#)
- [Viewfinder Vertical Display](#)
- [Grid](#)
- [Histogram](#)
- [Lens Information Display](#)
- [Clearing Settings](#)

You can customize the details and screens of information shown on the screen or in the viewfinder when you shoot.

Customizing Information on the Screen

1. Select [: Shooting info. disp.].

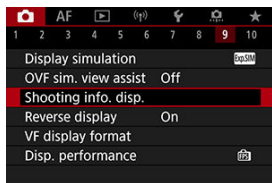

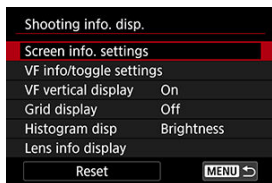

2. Select [Screen info. settings].

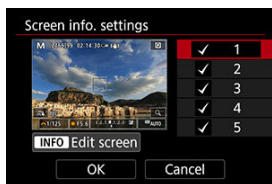

3. Select screens.



- Turn the  dial to select screens of information to show on the camera.
- For information you prefer not to display, press the  button to clear the checkmark [✓].
- To edit the screen, press the < **INFO** > button.

4. Edit the screen.

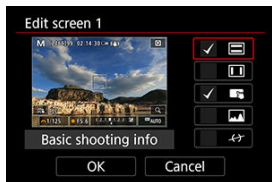

- Turn the $\langle \text{INFO} \rangle$ dial to select options to show on the screen of information.
- For items you prefer not to display, press the $\langle \text{INFO} \rangle$ button to clear the checkmark [✓].
- Select [OK] to register the setting.

1. Select []: Shooting info. disp.].

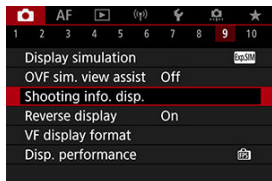

2. Select [VF info/toggle settings].

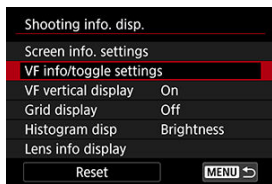



3. Select screens.

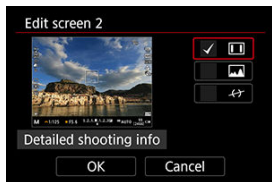

- Turn the dial to select screens of information to show on the camera.
- For information you prefer not to display, press the button to clear the checkmark [✓].
- To edit the screen, press the < INFO > button.

4. Edit the screen.



- Turn the <  > dial to select options to show on the screen of information.
- For items you prefer not to display, press the <  > button to clear the checkmark [✓].
- Select [OK] to register the setting.

Viewfinder Vertical Display

You can select how viewfinder information is displayed when you are shooting still photos vertically.

1. Select [📷: Shooting info. disp.].

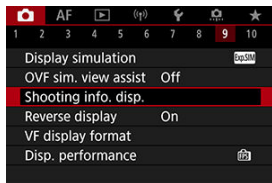

2. Select [VF vertical display].

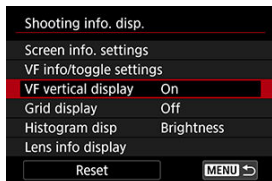

3. Select an option.

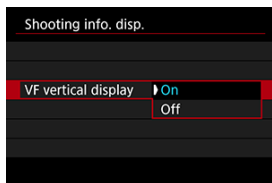

- **On**
Information is automatically rotated, making it easier to read.
- **Off**
Information is not automatically rotated.

A grid can be displayed on the screen and viewfinder.

1. Select [: Shooting info. disp.].

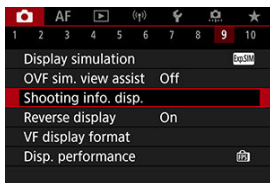

2. Select [Grid display].

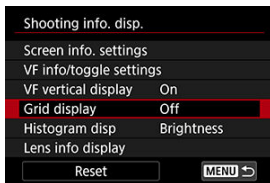

3. Select an option.

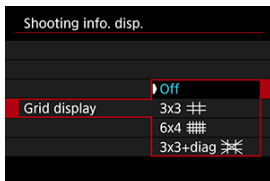

You can select the content and display size of the histogram.

1. Select [**📷**: Shooting info. disp.].

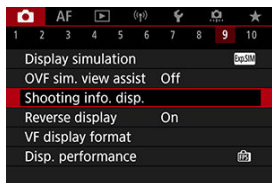

2. Select [**H**istogram disp].

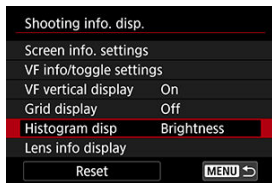

3. Select an option.

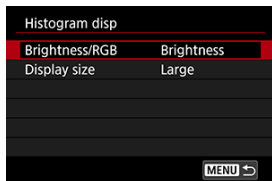

- Select the content ([**Brightness**] or [**RGB**]) and display size ([**Large**] or [**Small**]).

Lens Information Display

You can display information about the lens in use.

1. Select [: Shooting info. disp.].

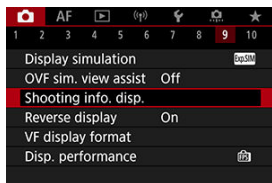

2. Select [Lens info display].



3. Select an option.

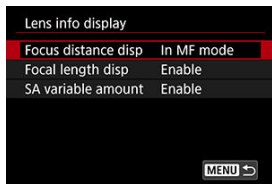

- **Focus distance disp**

You can display focus distance when using RF lenses. In focus distance display, you can select the timing and unit of measurement.

- **Focal length disp**

You can display the focal length of the lens in use.

- **SA variable amount**

You can display the amount of correction set when using lenses featuring spherical aberration control.

* SA: spherical aberration

1. Select [**☑**]: Shooting info. disp.].

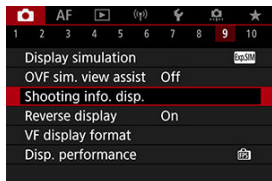

2. Select [**Reset**].

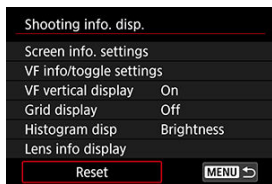

3. Select [**OK**].

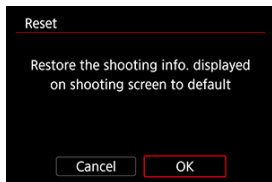

Reverse Display

A mirror image can be displayed when you shoot with the screen rotated toward the subject (toward the front of the camera).

1. Select [**☑**: Reverse display].

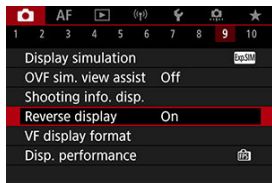

2. Select [**On**].

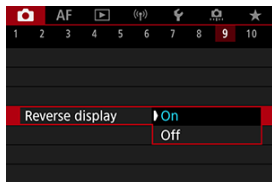

- Select [**Off**] if you prefer not to reverse display when the screen is facing the subject.

Viewfinder Display Format

You can select how information is presented in the viewfinder.

1. Select [📷]: VF display format].

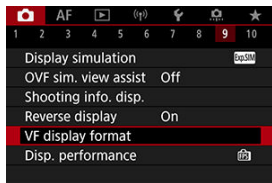

2. Select an option.

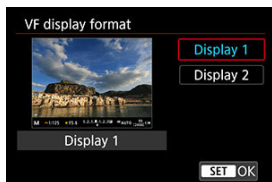

Display Performance

You can select the performance parameter to prioritize in shooting screen display for still photos.

1. Select [: Disp. performance].

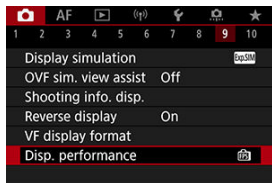

2. Select an option.

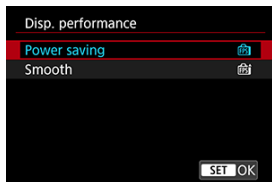

When set to [Smooth]

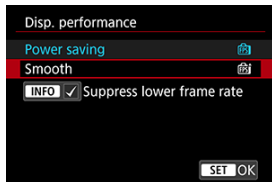

- By pressing the <INFO> button to add a checkmark, you can include low-light locations in the scenarios for suppressing lower display frame rates.
- The high frame rate (119.88 fps) display of the [Smooth] option is used for shooting standby in viewfinder shooting.

 Caution

- Some shooting conditions and camera operations may prevent smooth, high frame rate display, even when set to **[Smooth]**.
- Shooting under low light with **[Suppress lower frame rate]** set for shooting screen display may affect performance as follows.
 - Faster battery consumption
 - Fewer shots available
 - Lower image display brightness
 - Difficulty in autofocusing
 - Lower metering precision
 - Lower flicker detection precision
 - Lower subject detection precision

General Still Photo Shooting

 [Information Display](#)

 [General Still Photo Shooting Precautions](#)

Information Display

For details on the icons displayed for still photo shooting, see [Information Display](#).

Note

- White display of the **[Exp.SIM]** icon indicates that your shots will be about as bright as the image displayed.
- If the **[Exp.SIM]** icon is blinking, it indicates that the image is displayed at a brightness that differs from the actual shooting result because of low- or bright-light conditions. However, the actual image recorded will reflect the exposure setting. Note that the noise may be more noticeable than the actual image recorded.
- Display simulation may not be performed under some shooting settings. The **[Exp.SIM]** icon and histogram will be displayed in gray. The image will be displayed on the screen at the standard brightness. The histogram may not be properly displayed in low- or bright-light conditions.
- Histogram display is available when **[CAM: Display simulation]** is set to an option other than **[Disable]** ().

General Still Photo Shooting Precautions



Caution

- Do not point the camera toward an intense light source, such as the sun or an intense artificial light source. Doing so may damage the image sensor or the camera's internal components.

Image quality

- When you shoot at high ISO speeds, noise (such as dots of light and banding) may become noticeable.
- Shooting in high temperatures may cause noise and irregular colors in the image.
- Frequent shooting over an extended period may cause high internal temperatures and affect image quality. When you are not shooting, always turn off the camera.
- If you shoot a long exposure while the camera's internal temperature is high, image quality may decline. Stop shooting and wait a few minutes before shooting again.

White internal temperature warning icon

- A white  icon indicates high internal camera temperature. The white  icon indicates that the image quality of still photos will decline. Stop shooting for a while and allow the camera to cool down.
- If the camera's internal temperature is high, the quality of images shot with a high ISO speed or long exposure may decline even before the white  icon is displayed.

Shooting results

- In magnified view, the shutter speed and aperture value will be displayed in orange. If you take the picture in magnified view, the exposure may not come out as desired. Return to the normal view before taking the picture.
- Even if you take the picture in magnified view, the image will be captured with the image area of the normal view.

Images and display

- Under low- or bright-light conditions, the displayed image may not reflect the brightness of the captured image.
- Although noise may be noticeable in images under low light (even at low ISO speeds), there will be less noise in your shots, due to differences in image quality between displayed and captured images.
- The screen may flicker if the light source (lighting) changes. In this case, stop shooting temporarily and resume under the light source you will use.
- Pointing the camera at different direction may momentarily prevent correct display of brightness. Wait until the brightness level stabilizes before shooting.
- If there is a very bright light source in the image, the bright area may appear black on the screen. However, the actual captured image will correctly show the bright area.





- Under low light, bright [: **Screen brightness**] settings may cause noise or irregular colors in images. However, the noise or irregular colors will not be recorded in the captured image.
- When you magnify the image, the image sharpness may look more pronounced than in the actual image.

Lens

- If the attached lens has an Image Stabilizer and you set the Image Stabilizer switch to < **ON** >, the Image Stabilizer will operate at all times even if you do not press the shutter button halfway. The Image Stabilizer consumes battery power and may decrease the number of available shots depending on the shooting conditions. When the Image Stabilizer is not necessary, such as when using a tripod, it is recommended that you set the Image Stabilizer switch to < **OFF** >.
- With EF lenses, focus preset during shooting is only available when using (super) telephoto lenses equipped with this function released in and after the second half of 2011.







Note

- The field of view is approx. 100% (with image quality set to JPEG .
- If the camera is idle over an extended period, the screen will turn off automatically after the time set in [**Auto power off**] or [**Viewfinder off**] under [: **Power saving**]. The camera then turns off automatically after the time set in [**Auto power off**] (.
- Using a commercially available HDMI cable, you can display images on a television (). Note that no sound will be output.

Movie Recording



Movie recording is enabled by setting the power switch to <  >.

☆ to the right of titles indicates functions only available in [, [, [, or [] mode.

Caution

- When switching from still photo shooting to movie recording, check the camera settings again before recording movies.

Note

- You can record movies by pressing the movie shooting button during still photo shooting.

- [Tab Menus: Movie Recording](#)
- [Movie Recording](#)
- [Movie Recording Size](#)
- [High Frame Rate](#)
- [Digital Zoom](#)
- [Sound Recording](#)
- [Canon Log Settings](#) ☆
- [Time-Lapse Movies](#)
- [Movie Self-Timer](#)
- [Image Stabilizer \(IS Mode\)](#)
- [Shutter Button Function for Movies](#)
- [Zebra Settings](#) ☆
- [Time Code](#)
- [Other Menu Functions](#)
- [General Movie Recording Precautions](#)

Tab Menus: Movie Recording

● Shooting 1

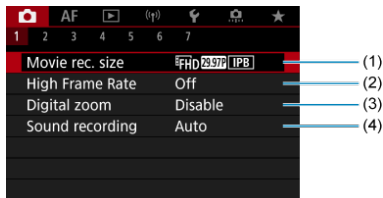

- (1) [Movie rec. size](#)
- (2) [High Frame Rate](#)
- (3) [Digital zoom](#)
- (4) [Sound recording](#)

● Shooting 2

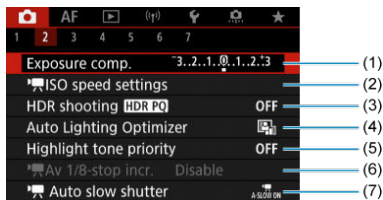

- (1) [Exposure comp.](#) ☆
- (2) [ISO speed settings](#) ☆
- (3) [HDR shooting HDR PQ](#) ☆
- (4) [Auto Lighting Optimizer](#) ☆
- (5) [Highlight tone priority](#) ☆
- (6) [Av 1/8-stop incr.](#) ☆
- (7) [Auto slow shutter](#) ☆

● Shooting 3

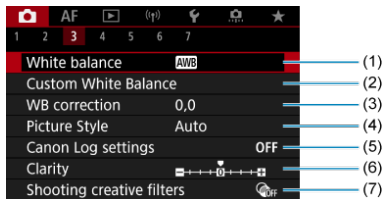

- (1) [White balance](#) ☆
- (2) [Custom White Balance](#) ☆
- (3) [WB correction](#) ☆
- (4) Picture Style
 - [Picture Style Selection](#) ☆
 - [Picture Style Customization](#) ☆
 - [Picture Style Registration](#) ☆
- (5) [Canon Log settings](#) ☆
- (6) [Clarity](#) ☆
- (7) [Shooting creative filters](#) ☆

● Shooting 4

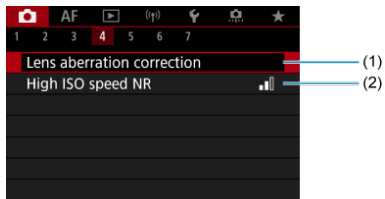

- (1) [Lens aberration correction](#) ☆
- (2) [High ISO speed NR](#) ☆

● Shooting 5



- (1) [Time-lapse movie](#)
- (2) [Movie self-timer](#)
- (3) [Remote control](#)

● Shooting 6

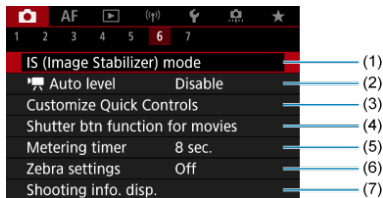

- (1) [IS \(Image Stabilizer\) mode](#)
- (2) [Auto level](#)
- (3) [Customize Quick Controls](#) ☆
- (4) [Shutter btn function for movies](#)
- (5) [Metering timer](#) ☆
- (6) [Zebra settings](#) ☆
- (7) [Shooting info. disp.](#)

● Shooting 7

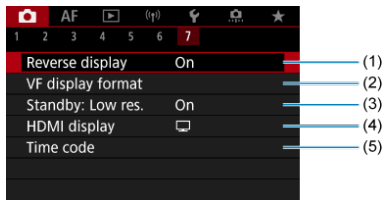

- (1) [Reverse display](#)
- (2) [VF display format](#)
- (3) [Standby: Low res.](#)
- (4) [HDMI display](#)
- (5) [Time code](#)

In Creative Zone modes, the following screens are displayed.

● Shooting 1

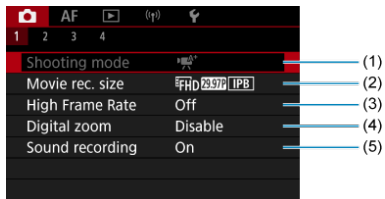

- (1) [Shooting mode](#)
- (2) [Movie rec. size](#)
- (3) [High Frame Rate](#)
- (4) [Digital zoom](#)
- (5) [Sound recording](#)

● Shooting 2

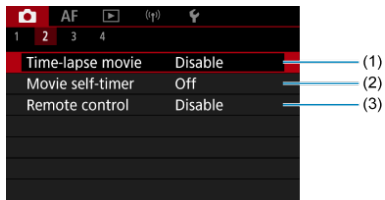

- (1) [Time-lapse movie](#)
- (2) [Movie self-timer](#)
- (3) [Remote control](#)

● Shooting 3

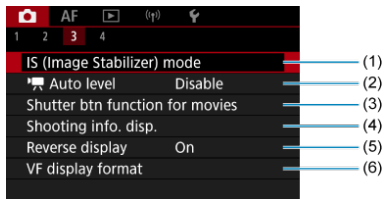



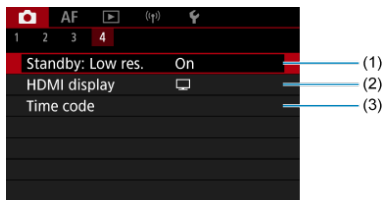

- (1) [IS \(Image Stabilizer\) mode](#)
- (2) [Auto level](#)
- (3) [Shutter btn function for movies](#)
- (4) [Shooting info. disp.](#)
- (5) [Reverse display](#)
- (6) [VF display format](#)

● Shooting 4



- (1) [Standby: Low res.](#)
- (2) [HDMI display](#)
- (3) [Time code](#)

Movie Recording

- [Select a Recording Mode](#)
-  [Autoexposure Recording](#)
-  [Shutter-Priority AE](#)
-  [Aperture-Priority AE](#)
- [Scene Icons](#)
- [ISO Speed in \[!\[\]\(6aefe9a3d997eb8b55c40ecd5fa7053f_img.jpg\)\]\[!\[\]\(baa8f8ba8c970db55300f5bb45bb3460_img.jpg\)\]\[!\[\]\(a6e28495607b2299466d3d5d3193848c_img.jpg\)\]\[!\[\]\(ed205fcb6e75c95529564351570724d7_img.jpg\)\] Mode](#)
-  [Manual Exposure Recording](#)
- [ISO Speed in \[!\[\]\(4e3fbe2ef35291baab7a42cb80921f3b_img.jpg\)\] Mode](#)
- [Shutter Speed](#)
- [Creative Filters](#)
- [HDR Movie Recording](#)
- [Still Photo Shooting](#)
- [Information Display \(Movie Recording\)](#)

Select a Recording Mode

Set the power switch to <  >, then use the Mode dial to select a recording mode.

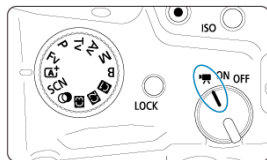



Mode Dial	Mode	Operation
		The camera detects the type of scene and sets all settings accordingly.
Fv		Exposure is controlled automatically to suit the brightness.
P		
Tv		You can manually set the shutter speed for movie recording.
Av		You can manually set the aperture value for movie recording.
M		You can manually set the shutter speed, aperture value, and ISO speed for movie recording.
B		Exposure is controlled automatically to suit the brightness.
	Customized	Operation follows your customized settings in [: Custom shooting mode (C1-C3)]. (Default: P)
		Movie recording with filter effects applied.
SCN		You can record high dynamic range movies that retain detail in highlights of high-contrast scenes.

Note

- You can also record movies with the power switch set to < **ON** >. In this case, operation corresponds to < > when the Mode dial is set to < >. When the Mode dial is set to an option other than < >, operation corresponds to < **P** >.

Exposure is controlled automatically to suit the brightness.

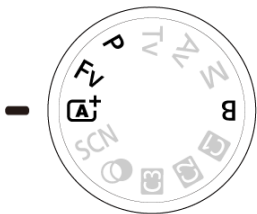

1. Set the recording mode to  or .

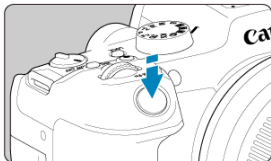

- Turn the Mode dial to , **P**, **Fv**, or **B**.

2. Focus on the subject.



- Before recording a movie, focus with AF  or manual focus .
- By default, [**AF: Movie Servo AF**] is set to [**Enable**] so that the camera always keeps focusing .
- When you press the shutter button halfway, the camera focuses using your specified AF area.

3. Record the movie.

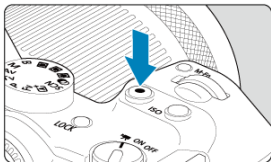

- Press the movie shooting button to start recording a movie. You can also start recording a movie by tapping [●] on the screen.



- While the movie is being recorded, the [●REC] icon (1) will be displayed in the upper right of the screen.

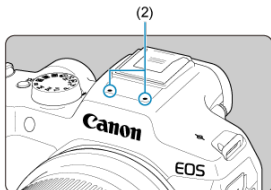

- Sound is recorded with the movie microphone (2).
- To stop recording the movie, press the movie shooting button again. You can also stop recording a movie by tapping [■] on the screen.

Tv Shutter-Priority AE

[ Tv] recording mode enables you to set your preferred shutter speed for movies. ISO speed and aperture values are set automatically to suit the brightness and obtain standard exposure.

1. Set the recording mode to [ Tv].

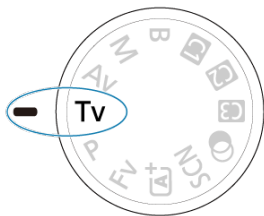

- Turn the Mode dial to < **Tv** >.

2. Set the shutter speed (1).



(1)

- Set it by looking at the screen as you turn the <  > dial.
- The available shutter speeds vary depending on the frame rate.

3. Focus and record the movie.



- Same as steps 2 and 3 for [Autoexposure Recording](#).

Caution

- Avoid adjusting shutter speed while recording movies, which will record changes in exposure.
- When recording a movie of a moving subject, a shutter speed of approx. 1/25 sec. to 1/125 sec. is recommended. The faster the shutter speed, the less smooth the subject's movement will look.
- If you change the shutter speed while recording under fluorescent or LED lighting, image flicker may be recorded.

[] recording mode enables you to set your preferred aperture value for movies. ISO speed and shutter speed are set automatically to suit the brightness and obtain standard exposure.

1. Set the recording mode to [].

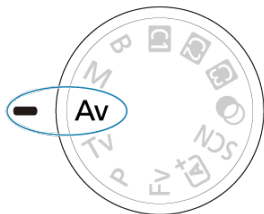

3. Focus and record the movie.



- Same as steps 2 and 3 for [Autoexposure Recording](#).

Caution

- Avoid adjusting the aperture value while recording movies, which will record changes in exposure caused by aperture adjustment.

Note

Notes for [M^A], [P^A], [M^T], and [M^{AV}] modes

- You can lock the exposure (AE lock) by pressing the < * > button (except in [M^A] mode). After locking, AE lock can be canceled by pressing the < * > button again.
- Exposure compensation can be set in a range of up to ±3 stops by turning the <  > dial (except in [M^A] mode).
- In [M^A] and [P^A] mode, the ISO speed, shutter speed, and aperture value are not recorded in movie Exif information.
- The camera is compatible with Speedlite functionality to activate the LED light automatically under low light when recording movies in [M^A], [P^A], [M^T], and [M^{AV}] modes. For details, refer to the Instruction Manual of the EX series Speedlite equipped with an LED light.

Scene Icons



In [A] recording mode, the camera detects the type of scene and sets all settings accordingly. The detected scene type is indicated in the upper left of the screen. For icon details, see [Scene Icons](#).

ISO Speed in [P/A*]/[P/Av]/[Tv]/[Av] Mode

ISO speed is set automatically. See [ISO Speed in Movie Recording](#).

Manual Exposure Recording

You can manually set the shutter speed, aperture value, and ISO speed for movie recording.

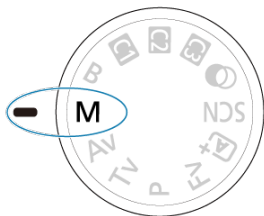

1. Set the recording mode to .

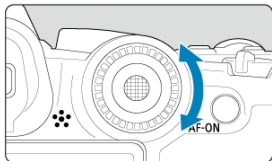
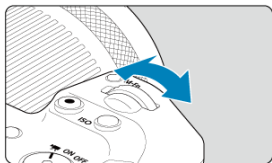

- Turn the Mode dial to **<M>**.

2. Set the shutter speed, aperture value, and ISO speed.



- Press the shutter button halfway and check the exposure level indicator.
- Turn the <  > dial to set the shutter speed (1) and the <  > dial to set the aperture value (2), and press the < **ISO** > button to set the ISO speed (3).
- Available shutter speeds vary by frame rate ()







3. Focus and record the movie.

- Same as steps 2 and 3 for [Autoexposure Recording](#).

Caution

- During movie recording, avoid changing the shutter speed, aperture value, or ISO speed, which may record changes in the exposure or create more noise at high ISO speeds.
- When recording a movie of a moving subject, a shutter speed of approx. 1/25 sec. to 1/125 sec. is recommended. The faster the shutter speed, the less smooth the subject's movement will look.
- If you change the shutter speed while recording under fluorescent or LED lighting, image flicker may be recorded.

Note

- Exposure compensation with ISO Auto can be set in a range of ± 3 stops as follows.
 - Tap the exposure level indicator
 - Set [: Exposure comp.]
 - Turn the control ring while pressing the shutter button halfway
- When ISO Auto is set, you can press the <  > button to lock the ISO speed. After locking during movie recording, ISO speed lock can be canceled by pressing the <  > button again.
- If you press the <  > button and recompose the shot, you can see the exposure level difference on the exposure level indicator () compared to when the <  > button was pressed.

ISO Speed in [M] Mode

You can set the ISO speed manually or select **[AUTO]** to set it automatically. For details on ISO speed, see [ISO Speed in Movie Recording](#).

Shutter Speed

Available shutter speeds in [i] and [M] mode vary depending on the frame rate you have set for your specified movie recording size.

Frame Rate	Shutter Speed (Sec.)	
	Normal Movie Recording	High Frame Rate Movie Recording
119.9P	-	1/4000-1/125
100.0P		1/4000-1/100
59.94P	1/4000-1/8	-
50.00P		
29.97P		
25.00P		
23.98P		

Creative Filters

In <  > (creative filters) mode, you can record movies with one of five filter effects applied: Dream, Old movies, Memory, Dramatic B&W, or Miniature effect movies.

Recording size can be set to   (NTSC) or  (PAL).

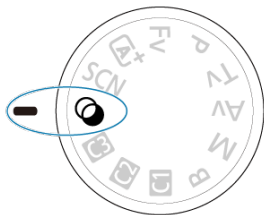

1. Set the Mode dial to <  >.



2. Press the <  > button.



3. Select [].



- Press the <  > <  > keys to select the setting item, then press the <  > button.

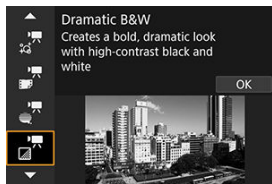



4. Select a filter effect.



- Turn the <  > dial to select a filter effect (), then press the <  > button.
- For Miniature effect movies, move the AF point to the position to focus on. Move the scene frame if the AF point is outside of it, so that the AF point is aligned with it.

5. Adjust the filter effect level.



- Press the <  > button and select <  >.
- Turn the <  > dial to select a filter effect level, then press the <  > button.
- When setting up miniature effect movies, select the playback speed.



6. Record the movie.

Caution

- A magnified view is not available.
- No histogram is displayed.
- Subjects such as the sky or white walls may not be rendered with smooth gradation and may have noise or irregular exposure or colors.



Note

- Can also be configured from [: **Shooting creative filters**] in Creative Zone modes ()

Creative Filter Characteristics

-  **Dream**

Applies a soft, dreamy, otherworldly appearance. Gives the movie a soft look overall, blurring the periphery of the screen. You can adjust the blurry areas along the screen edges.

-  **Old movies**

Creates an atmosphere like an old film by adding wavering, scratches, and flickering effects to the image. The top and bottom of the screen are masked in black. You can modify the wavering and scratch effects by adjusting the filter effect.

-  **Memory**

Creates the atmosphere of a distant memory. Gives the movie a soft look overall, reducing brightness of the periphery of the screen. You can modify the overall saturation and the dark areas along the screen edges by adjusting the filter effect.

-  **Dramatic B&W**

Creates an atmosphere of dramatic realism with high-contrast black and white. You can adjust the graininess and black-and-white effect.

-  **Miniature effect movies**

You can record movies with a miniature (diorama) effect. Select the playback speed and record.

Recording under the default setting will keep the center in sharp focus.

To move the area that looks sharp (the scene frame), see "Adjusting the Miniature Effect" (🔗). 1-point AF is used as the AF area. Recording with the AF point and scene frame aligned is recommended. The AF point and scene frame are hidden during recording.

In step 5, set the playback speed to [5x], [10x], or [20x] before recording.

Speed and playback time (for a 1-minute movie)

Speed	Playback Time
5x	Approx. 12 sec.
10x	Approx. 6 sec.
20x	Approx. 3 sec.

Caution

(Miniature effect movies)

- Sound is not recorded.
- Movie Servo AF is disabled.
- Editing is not available for miniature effect movies with a playback time less than 1 sec. (🔗).

HDR Movie Recording

You can record high dynamic range movies that retain detail in highlights of high-contrast scenes.

Note

- Movies are recorded at **FHD 29.97P 10PB** (NTSC) or **FHD 25.00P 10PB** (PAL).

1. Set the Mode dial to **< SCN >**.

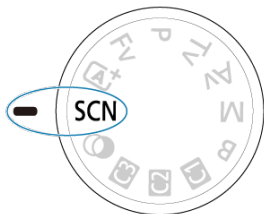

2. Record an HDR movie.

- Record the movie in the same way as normal movie recording.
- For details on file sizes and the recording time available, see [Movie recording](#).

 **Caution**

- Since multiple frames are merged to create an HDR movie, certain parts of the movie may look distorted. This is more noticeable in handheld recording affected by camera shake, so consider using a tripod. Note that even if a tripod is used for recording, afterimages or noise may become more noticeable, compared to normal playback, when the HDR movie is played back frame-by-frame or in slow motion.
- Image color and brightness may change significantly for a moment if you change settings for HDR movie recording. Also, the movie will not be updated for a moment, and the frame stops momentarily. Be aware of this when recording movies to external devices via HDMI.



Still Photo Shooting

Still photo shooting is not supported in movie recording mode. To shoot still photos, stop recording and change the [Shooting mode] setting to still photos first.

Information Display (Movie Recording)

For details on the icons on the movie recording screen, see [Information Display](#).

Caution

- The remaining time displayed for movie recording is only a guideline.
- Movie recording may stop before the initially displayed recording time elapses if the red  icon appears due to high internal camera temperature during recording (.

Movie Recording Size

- [4K Movie Recording](#)
- [Image Area](#)
- [Cards That Can Record Movies](#)
- [Movie Files Exceeding 4 GB](#)
- [Total Movie Recording Time and File Size Per Minute](#)
- [Movie Recording Time Limit](#)

You can set the recording size, frame rate, and compression method in [CAMERA: **Movie rec. size**].

Note that the frame rate is updated automatically to match the [CAMERA: **Video system**] setting (CAMERA).

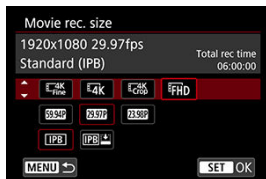

Image Size		Aspect Ratio
4K Fine	3840×2160	16:9
4K	3840×2160	16:9
4K Crop	3840×2160	16:9
FHD	1920×1080	16:9

Caution

- If you change the [CAMERA: **Video system**] setting, also set [CAMERA: **Movie rec. size**] again.
- Other devices may not play movies such as 4K, FHD 59.94P/50.00P, and High Frame Rate movies normally, because playback is processing-intensive.
- Sharpness and noise vary slightly depending on the movie recording size setting and lens used.

 **Note**

- To obtain better performance with the card, formatting the card with the camera before recording movies is recommended (🔗).
- Movies cannot be recorded in HD or VGA quality.

4K Movie Recording



- Recording 4K movies requires a stable card with a fast writing speed. For details, see [Cards That Can Record Movies](#).
- 4K movie recording greatly increases the processing load, which may increase the internal camera temperature faster or higher than for regular movies. **If a white  or red  icon appears during movie recording, the card may be hot, so stop recording the movie and let the camera cool down before removing the card. (Do not remove the card immediately.)**
- From a 4K movie, you can select any frame to save to the card as a JPEG still image (🔗).

Image Area

The movie image area varies depending on the movie recording size setting.

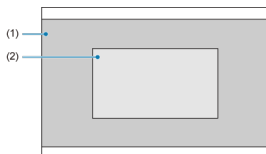

- (1) $\overline{\text{4K}}_{\text{Fine}}$ $\overline{\text{4K}}$ (3840×2160) / $\overline{\text{4K}}$ (time-lapse) / $\overline{\text{FHD}}$ (1920×1080) / $\overline{\text{FHD}}$ (time-lapse)
(2) $\overline{\text{4K}}_{\text{Crop}}$ (3840×2160)

⚠ Caution

- Recording with Movie digital IS () further crops the image around the center of the screen.

Frame rate (fps: frames per second)

- **[119.9P] 119.9 fps/[59.94P] 59.94 fps/[29.97P] 29.97 fps**
For areas where the TV system is NTSC (North America, Japan, South Korea, Mexico, etc.). For [119.9P], see [High Frame Rate](#).
- **[100.0P] 100.00 fps/[50.00P] 50.00 fps/[25.00P] 25.00 fps**
For areas where the TV system is PAL (Europe, Russia, China, Australia, etc.). For [100.0P], see [High Frame Rate](#).
- **[23.98P] 23.98 fps**
Mainly for cinematic purposes. **23.98P** (23.98 fps) is available when [: **Video system**] is set to [**For NTSC**].

Compression method

- **[IPB] IPB (Standard)**
Compresses multiple frames at a time efficiently for recording.
- **[IPB ] IPB (Light)**
Since the movie is recorded at a bit rate lower than with IPB (Standard), the file size will be smaller than with IPB (Standard) and the playback compatibility will be higher. This will make the available recording time longer than with IPB (Standard) (with a card of the same capacity).

Movie recording format

- **[MP4] MP4**
All movies you record with the camera are recorded as movie files in MP4 format (file extension “.MP4”).

Cards That Can Record Movies

See [Card performance requirements](#) for details on cards supporting all movie recording sizes.

Test cards by recording a few movies to make sure they can record correctly at your specified size (🔗).

Caution

- Before recording 4K movies, format cards by selecting [**Low level format**] in [: **Format card**] (🔗).
- If you use a slow-writing card when recording movies, the movie may not be recorded properly. Also, if you play back a movie on a card with a slow reading speed, the movie may not be played back properly.
- When recording movies, use high-performance cards with a writing speed sufficiently higher than the bit rate.
- When movies cannot be recorded properly, format the card and try again. If formatting the card does not resolve the problem, refer to the card manufacturer's website, etc.

Note

- To obtain better performance with the card, formatting the card with the camera before recording movies is recommended (🔗).
- To check the card's writing/reading speed, refer to the card manufacturer's website, etc.

Movie Files Exceeding 4 GB

- **Using SDHC cards formatted with the camera**

If you use the camera to format an SDHC card, the camera will format it in FAT32. With a FAT32-formatted card, if you record a movie and the file size exceeds 4 GB, a new movie file will be created automatically.

When you play back the movie, you will have to play back each movie file individually. Movie files cannot be played back automatically in consecutive order. After the movie playback ends, select the next movie and play it back.

- **Using SDXC cards formatted with the camera**

If you use the camera to format an SDXC card, the camera will format it in exFAT. When using an exFAT-formatted card, even if the file size exceeds 4 GB during movie recording, the movie will be saved as a single file (rather than being split into multiple files).

Caution

- When importing movie files exceeding 4 GB to a computer, use either EOS Utility or a card reader (🔗). It may not be possible to save movie files exceeding 4 GB if you attempt this using standard features of the computer's operating system.

Total Movie Recording Time and File Size Per Minute

For details, see [Movie recording](#).

Movie Recording Time Limit

- **When recording non-High Frame Rate movies**

The maximum recording time per movie is 6 hr. Once 6 hr. is reached, recording stops automatically. You can start recording a movie again by pressing the movie shooting button (which records the movie as a new file).

- **When recording High Frame Rate movies**

The maximum recording time per movie is 1 hr. 30 min. Once 1 hr. 30 min. is reached, recording automatically stops. You can start recording a High Frame Rate movie again by pressing the movie shooting button (which records the movie as a new file).



Caution

- The camera's internal temperature may rise and less recording time may be available after extended movie playback/Live View display.

High Frame Rate

You can record movies at a high frame rate of 119.9 fps or 100.0 fps. This is ideal for recording movies that will be played back in slow motion. The maximum recording time per movie is 1 hr. 30 min.

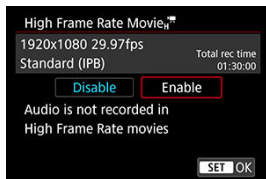

- Movies are recorded in **FHD 119.9P IPB** (IPB) or **FHD 100.0P IPB** (IPB) quality.
- Sound is not recorded in High Frame Rate movies.
- Time code display during movie recording advances 4 sec. per second.
- Because High Frame Rate movies are recorded as 29.97 fps/25.00 fps movie files, they are played in slow motion at 1/4 speed.

Caution

Precautions when set to [High Frame Rate: On]

- Time codes are not recorded when [Count up] is set to [Free run] in [Time code].
- Check the [Movie rec. size] setting if you return this setting to [Disable].
- The screen may flicker if you record High Frame Rate movies under fluorescent or LED lighting.
- For a moment when you start or stop recording High Frame Rate movies, the movie is not updated, and the frame stops momentarily. Be aware of this when recording movies to external devices via HDMI.
- Movie frame rates shown on the screen as you record High Frame Rate movies do not correspond to the frame rate of the movie recorded.
- Headphones cannot be used (no sound is audible).
- ISO speed can be set within ISO 100–12800. By changing the maximum for the ISO speed range in [ISO speed settings] to H (25600), you can also set up to H (25600) in [M] mode.
- The frame rate of HDMI video output is 59.94 fps or 50.00 fps.
- The camera's internal temperature may rise and less recording time may be available after extended movie playback or image display.

Digital Zoom

With the recording size set to [FHD 29.97P]/[FHD 23.98P] (NTSC) or [FHD 25.00P] (PAL), you can shoot with approx. 1–10× digital zoom.

1. Select [📷: Digital zoom].

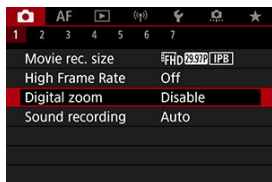

2. Select an option.

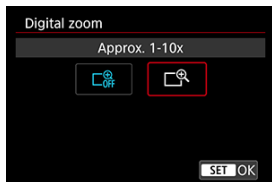

- Select the amount to zoom, then press the <  > button.
- Press the < MENU > button to close the menu.

3. Use digital zoom.



- To zoom, either tap [**W/T**] in the lower right or, if you have assigned the < ▲ > < ▼ > keys to [**Digital zoom**] in [**Customize buttons**], press the < ▲ > < ▼ > keys.
- The digital zoom bar will appear.
- Tap [**▲T**] or press the < ▲ > key to zoom in, and tap [**▼W**] or press the < ▼ > key to zoom out.
- Pressing the shutter button halfway focuses with [**1-point AF**] (fixed at center).
- To cancel digital zoom, select [**Disable**] in step 2.

⚠ Caution

- Using a tripod to prevent camera shake is recommended.
- Time-lapse movies, Creative filters and Movie digital IS are not available.
- Maximum ISO speed is ISO 12800.
- A magnified view is not available.
- Since Movie digital zoom processes the image digitally, the image will look grainier at higher magnifications. Noise, dots of light, etc. may also become noticeable.
- The scene icon will not be displayed.
- Also see [Shooting Conditions That Make Focusing Difficult](#).
- The camera's internal temperature may rise and reduce the available recording time.
- Overheat control is set to [**Off**] and cannot be changed (🔒).

Sound Recording

[Sound Recording/Sound-Recording Level](#)

[Wind Filter](#)

[Audio Noise Reduction](#)

You can record movies while recording sound with the built-in stereo microphone or an external stereo microphone. You can also freely adjust the sound-recording level.

Use : **Sound recording** to set sound recording functions.

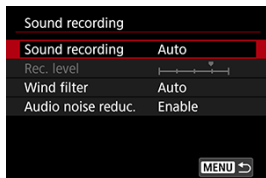

Caution

- Sounds from Wi-Fi operations may be captured with built-in or external microphones. During sound recording, using the wireless communication function is not recommended.
- When connecting an external microphone or headphones to the camera, be sure to insert the plug all the way in.
- The camera's built-in microphone may also record mechanical sounds of the lens or sounds of camera/lens operations if AF operations are performed or the camera or lens is operated during movie recording. If so, it may help reduce these sounds if you use an external microphone equipped with an output plug and position it away from the camera and lens.
- Do not connect anything other than an external microphone to the camera's external microphone IN terminal.
- Do not change the : **Sound recording** settings when listening with headphones. This may cause sudden loud output that may hurt your ears.

Note

- In Basic Zone modes, the settings available for : **Sound recording** are **[On]** and **[Disable]**. Set to **[On]** for automatic adjustment of the recording level.
- Audio is also output when the camera is connected to televisions via HDMI, unless **[Sound recording]** is set to **[Off]**. In case of feedback from television audio output, move the camera away from the television or turn down the volume.
- The volume balance between L/R (left/right) cannot be adjusted.
- Sound is recorded at a 48 kHz/16-bit sampling rate.

Sound Recording/Sound-Recording Level

● Auto

The sound-recording level is adjusted automatically. Auto level control will take effect automatically in response to the sound level.

● Manual

You can adjust the sound-recording level as needed. Select **[Rec. level]** and turn the  dial while looking at the level meter to adjust the sound-recording level. Look at the peak hold indicator, and adjust so that the level meter sometimes lights up on the right of the “12” (-12 dB) mark for the loudest sounds. If it exceeds “0”, the sound will be distorted.

● Disable

Sound will not be recorded.

Wind Filter

Set to **[Auto]** to reduce audio distortion in windy outdoor scenes. Disabled when external microphones are connected to the external microphone IN terminal. When the wind filter function takes effect, part of the low bass sounds will also be reduced.

Audio Noise Reduction

When recording with the built-in microphone, this feature reduces mechanical lens sounds caused by autofocusing, as well as white noise.

- **Disable**

Disables audio noise reduction.

- **Enable**

Enables audio noise reduction.

- **High**

Reduces audio noise more than with **[Enable]**.

Caution

- Audio quality may be different when set to **[Enable]** than when set to **[Disable]**.
- Although **[High]** reduces audio noise more than with **[Enable]**, this option may also have a greater impact on audio quality.
- Effectiveness of audio noise reduction varies by lens.
- Reducing white noise may make some noise more noticeable.
- Test recording in advance, because audio noise reduction effectiveness and resulting changes in audio quality vary by shooting conditions.
- To reduce audio noise in headphone output, configure **[Audio monitoring]** .

[Shooting Settings](#)

[Canon Log Image Quality](#)

Canon Log gamma curve takes full advantage of image sensor characteristics to ensure wide dynamic range for movies that will be processed in postproduction. With minimal loss of detail in shadows and highlights, movies retain more visual information across the dynamic range.

To work with Canon Log movies in postproduction, you can apply look-up tables (LUTs). LUT data can be downloaded from the Canon website.

1. Select [📷: Canon Log settings].

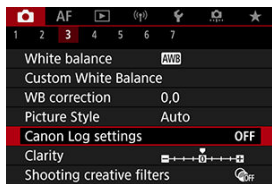

2. Select [Canon Log].

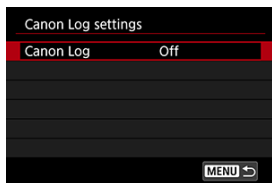

3. Select [On (C.LOG3)] (C).

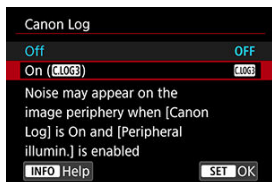

4. Set the options as desired.

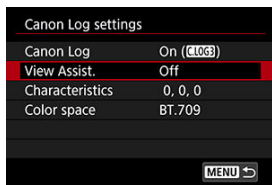

- Set [View Assist.](#), [Characteristics](#), and [Color space](#).

Canon Log

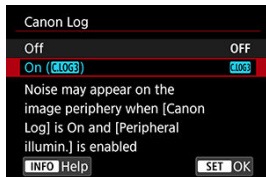

- **On (C.LOG3)**

Enables 10-bit recording of Canon Log movies to the card. Movies can also be recorded to an external device that supports 10-bit recording.

 **Note**

- YCbCr 4:2:2 (10-bit) color sampling and the BT.709/BT.2020/Cinema Gamut color space are used in Canon Log recording.

View Assist.

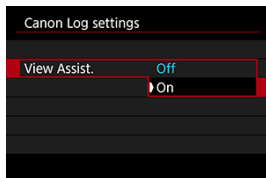

When played on the camera, these movies may look darker and have lower contrast than movies recorded with a Picture Style applied, due to Canon Log image characteristics, which are intended to ensure a wide dynamic range. For clearer display that makes it easier to check details, set **[View Assist.]** to **[On]**.

- Setting this feature to **[On]** does not affect movies recorded to the card, which are recorded using Canon Log characteristics. Similarly, HDMI video output has Canon Log characteristics, and View Assist is not used for it.

Note

- **[VAssist]** is shown on the information display screen during movie recording with View Assist.
- When set to **[On]**, View Assist is also used with magnified display.

Characteristics

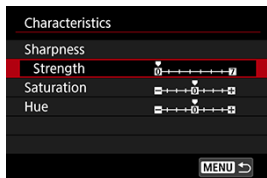

Adjust as needed. Select an option ([**Sharpness: Strength**], [**Saturation**], or [**Hue**]), adjust the effect level, then press the <  > button.

Sharpness: Strength		0: Weak outline emphasis	7: Strong outline emphasis
Saturation		-4: Low	+4: High
Hue*	Reds	-4: Toward magenta	+4: Toward yellow
	Greens	-4: Toward yellow	+4: Toward cyan
	Blues	-4: Toward cyan	+4: Toward magenta

* Reds, greens, and blues cannot be adjusted separately.

Color space

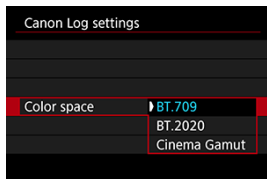

Choose [**BT.709**], [**BT.2020**], or [**Cinema Gamut**] as the color space for HDMI output or recording to cards.

Shooting Settings



- Manually setting the ISO speed to 100–640 will make the dynamic range narrower.
- Canon Log offers a dynamic range of approx. 1600% at ISO 800 or higher.
- The following are expanded ISO speeds: ISO 100, 125, 160, 200, 250, 320, 400, 500 and 640. [L] is displayed when an ISO speed is set.

Canon Log Image Quality

- With Canon Log, movies may be affected by horizontal banding, depending on the subject or shooting conditions. Record a few test movies and check the results in advance. In particular, noise may become more noticeable if you enhance the contrast when color-grading your movies.
- With Canon Log, skies, white walls, and similar subjects may be affected by noise or uneven gradation, exposure, or colors.
- Horizontal banding is more likely to occur when recording somewhat dark, flat subjects. This image noise may even occur at relatively low ISO speeds around ISO 800.
- If noise is noticeable, try recording under brighter conditions and adjusting brightness in color grading. Although dynamic range is narrower at ISO speeds lower than ISO 800, noise can also be reduced by recording this way.

Caution

General Canon Log shooting precautions

- Canon Log and Canon Log 2 are not supported.
- With Canon Log, autofocusing may be more difficult for subjects under low light, or for low-contrast subjects. Difficulty in autofocusing can be reduced by shooting near maximum aperture or using a bright lens.
- Noise may appear at image edges if **[Peripheral illum corr]** in : **Lens aberration correction** is set to **[Enable]** when Canon Log is set.
- Histograms with **[Canon Log]** in : **Canon Log settings** set to **[On (C.LOG3)]** are not based on conversion for View Assist display. Image areas shown in gray in the histogram roughly indicate signal values that are not used.

Note

Playing back movies recorded with Canon Log

- View Assist is not used during movie playback.

Time-Lapse Movies

[Approx. Time Available for Recording Time-Lapse Movies](#)

Still photos shot at a set interval can be stitched together automatically to create a 4K or Full HD time-lapse movie. A time-lapse movie shows how a subject changes in a much shorter period of time than the actual time it took. It is effective for a fixed-point observation of changing scenery, growing plants, celestial motion, etc.

Time-lapse movies are recorded in MP4 format at the following quality: $\text{4K } 29.97\text{P [ALL-I]}$ (NTSC)/ $\text{4K } 25.00\text{P [ALL-I]}$ (PAL) in 4K recording, and $\text{FHD } 29.97\text{P [ALL-I]}$ (NTSC)/ $\text{FHD } 25.00\text{P [ALL-I]}$ (PAL) in Full HD recording.

Note that the frame rate is updated automatically to match the **[Video system]** setting ().

1. Select [: Time-lapse movie].

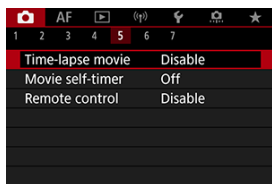

2. Select [Time-lapse].

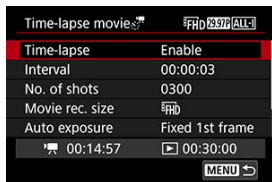

- Select [Enable].

3. Set [Interval].

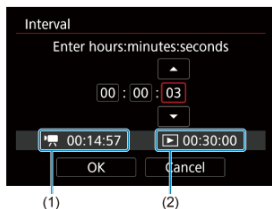

- Select [Interval].
- As you set the number, refer to the [▶] time required (1) and [▶] playback time (2).
- Select an option (hours : minutes : seconds).
- Press the < [↕] > button to display [↕].
- Set a value, then press the < [↕] > button. (Returns to [□].)
- Can be set in a range of [00:00:02]–[99:59:59]. (An interval of once per second is not available.)
- Select [OK] to register the setting.

4. Set [No. of shots].

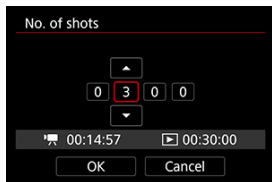

- Select **[No. of shots]**.
- As you set the number, refer to the time required ([📷]) and playback time ([▶]).
- Select the digit.
- Press the < [↶] > button to display [↷].
- Set a value, then press the < [↶] > button. (Returns to [□].)
- Can be set in a range of **[0002]–[3600]**.
- Make sure the playback time ([▶]) is not displayed in red.
- Select **[OK]** to register the setting.
- The playback time ([▶]) is displayed in red if the card does not have enough free space to record the specified number of shots. Although the camera can continue recording, the recording will stop when the card becomes full.
- Playback time ([▶]) is displayed in red if the **[No. of shots]** setting results in a file size exceeding 4 GB for a card not formatted in exFAT (🔒). If you keep recording in this condition and the movie file size reaches 4 GB, the time-lapse movie recording will stop.



Note

- For details on cards that can record time-lapse movies (card performance requirements), see [Card performance requirements](#).
- If the number of shots is set to 3600, the time-lapse movie will be approx. 2 min. in NTSC and approx. 2 min. 24 sec. in PAL.

5. Select [Movie rec. size].

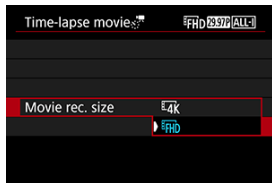

- **4K (3840×2160)**

The movie is recorded in 4K quality. The aspect ratio is 16:9. Additionally, the frame rate is 29.97 fps (29.97P) for NTSC and 25.00 fps (25.00P) for PAL, and movies are recorded in MP4 (MP4) format with ALL-I (ALL-I) compression.

- **FHD (1920×1080)**

The movie will be recorded in Full High-Definition (Full HD) quality. The aspect ratio is 16:9. Additionally, the frame rate is 29.97 fps (29.97P) for NTSC and 25.00 fps (25.00P) for PAL, and movies are recorded in MP4 (MP4) format with ALL-I (ALL-I) compression.

6. Set [Auto exposure].

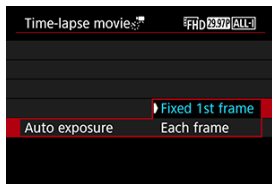

- **Fixed 1st frame**

When taking the first shot, metering is performed to set the exposure automatically to match the brightness. The exposure setting for the first shot will be applied to subsequent shots. Other shooting-related settings for the first shot will also be applied for subsequent shots.

- **Each frame**

Metering is also performed for each subsequent shot to set the exposure automatically to match the brightness. Note that any functions such as Picture Style and white balance that are set to **[Auto]** will be set automatically for each subsequent shot.

 **Caution**

- Significant changes in brightness between shots may prevent the camera from shooting at the specified interval when **[Interval]** is set to less than 3 sec. and **[Auto exposure]** is set to **[Each frame]**.

7. Set [Screen auto off].

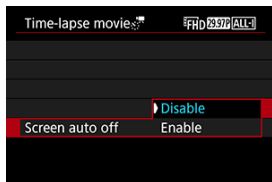

- **Disable**

Even during time-lapse movie recording, the image will be displayed. (The screen turns off only at the time of shooting.) Note that the screen will turn off when approx. 30 min. elapse after the shooting started.

- **Enable**

Note that the screen will turn off when approx. 10 sec. elapse after the shooting started.

Caution

- Even if [**Screen auto off**] is set to [**Disable**], the screen turns off during exposure. Also note that images may not be displayed if the interval between shots is too brief.

Note

- During time-lapse movie recording, you can press the < **INFO** > button to turn on/off the screen.

8. Set [Beep per taken].

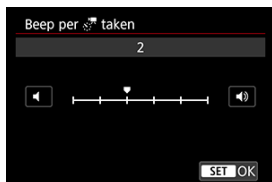

- Set to [0] to prevent the camera from beeping for each shot.

9. Check the settings.

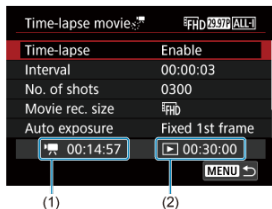

- **Time required (1)**

Indicates the time required to shoot the set number of shots with the set interval. If it exceeds 24 hours, “**** days” will be displayed.

- **Playback time (2)**

Indicates the movie recording time (time required to play back the movie) when creating the time-lapse movie in 4K movie or Full HD movie from the still photos taken with the set intervals.

10. Close the menu.

- Press the < MENU > button to turn off the menu screen.

11. Read the message.

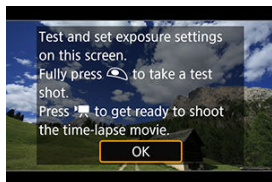

- Read the message and select [OK].

12. Take a test shot.



- Press the < INFO > button and double-check the Time required (1) and Interval (2) shown on the screen.
- As in still photo shooting, set the exposure and shooting functions, then press the shutter button halfway to focus.
- Press the shutter button completely to take a test shot, which is recorded to the card as a still photo.
- If there are no problems with the test shot, go to the next step.
- To take more test shots, repeat this step.



Note

- Test shots are captured in JPEG quality.
- In [] mode, you can set the shutter speed in a range of 1/4000 to 30 sec.
- You can set the maximum limit for Auto ISO in [] mode or in [] mode with ISO Auto, in the [:::] option of [:] ().
- If you have set [Half-press] in [: Shutter btn function for movies] to [Meter.+ Servo AF], it is automatically changed to [Meter.+One-Shot AF] when you set up time-lapse movie recording.

13. Press the movie shooting button.

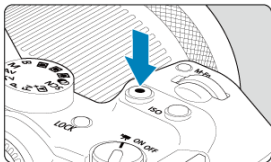

- The camera is now ready to start recording a time-lapse movie.
- To return to step 12, press the movie shooting button again.

14. Record the time-lapse movie.

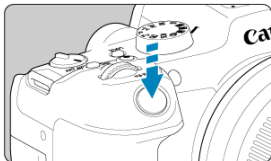



- **Press the shutter button completely to start recording the time-lapse movie.**
- AF will not work during time-lapse movie recording.
- A recording icon "●" is displayed on the screen as the time-lapse movie is recorded.
- When the set number of shots are taken, the time-lapse movie recording ends.
- **To cancel recording time-lapse movies, set [Time-lapse] to [Disable].**







Note

- Using a tripod is recommended.
- Taking test shots as in step 12 or even recording test time-lapse movies beforehand is recommended.
- The movie's field of view coverage for both the 4K and Full HD time-lapse movie recording is approx. 100%.
- To cancel time-lapse movie recording in progress, either press the shutter button completely or press the movie shooting button. The time-lapse movie shot so far will be recorded on the card.
- If the time required for recording is more than 24 hours but not more than 48 hours, "2 days" will be indicated. If three or more days are required, the number of days will be indicated in 24-hour increments.
- Even if the time-lapse movie's playback time is less than 1 sec., a movie file will still be created. In this case, "00'00" is indicated in **[Playback time]**.
- If the shooting time is long, using the household power outlet accessories (sold separately) is recommended.
- YCbCr 4:2:0 (8-bit) color sampling and the BT.709 color space are used for 4K/Full HD time-lapse movies.

Caution

- Do not point the camera toward an intense light source, such as the sun or an intense artificial light source. Doing so may damage the image sensor or the camera's internal components.
- Time-lapse movies cannot be recorded when the camera is connected to a computer with the interface cable, or when an HDMI cable is connected.
- Movie Servo AF will not function.
- If the shutter speed is 1/30 sec. or slower, the exposure of the movie may not be displayed properly (may differ from that of the resulting movie).
- Do not zoom the lens during time-lapse movie recording. Zooming the lens may cause the image to be out of focus, the exposure to change, or the lens aberration correction not to function properly.
- Recording time-lapse movies under flickering light may cause noticeable screen flickering, and images may be captured with horizontal stripes (noise) or irregular exposure.
- Images displayed as time-lapse movies are recorded may look different from the resulting movie (in details such as inconsistent brightness from flickering light sources, or noise from a high ISO speed).
- When recording a time-lapse movie under low light, the image displayed during shooting may look different from what is actually recorded in the movie. In such cases, the **[Exp.SIM]** icon will blink.
- If you move the camera from left to right (panning) or shoot a moving subject during time-lapse movie recording, the image may look extremely distorted.
- During time-lapse movie recording, auto power off will not take effect. Also, you cannot adjust the shooting function and menu function settings, play back images, etc.
- Sound is not recorded for time-lapse movies.
- To start or stop time-lapse movie recording, you can press the shutter button completely, regardless of the **[ Shutter btn function for movies]** setting.
- Significant changes in brightness between shots may prevent the camera from shooting at the specified interval when **[Interval]** is set to less than 3 sec. and **[Auto exposure]** is set to **[Each frame]**.
- If the shutter speed exceeds the shooting interval (such as for long exposures), or if a slow shutter speed is set automatically, the camera may not be able to shoot at the set interval. Shooting may also be prevented by shooting intervals nearly the same as the shutter speed.
- If the next scheduled shot is not possible, it will be skipped. This may shorten the recording time of the created time-lapse movie.
- If the time it takes to record to the card exceeds the shooting interval due to the shooting functions set or card performance, some of the shots may not be taken with the set intervals.
- The captured images are not recorded as still photos. Even if you cancel the time-lapse movie recording after only one shot is taken, it will be recorded as a movie file.
- Set **[ Time-lapse movie]** to **[Disable]** if you will connect the camera to a computer with the interface cable and use EOS Utility (EOS software). Options other than **[Disable]** will prevent the camera from communicating with the computer.



- Image stabilization is not applied in time-lapse movie recording.
- Time-lapse movie shooting ends if the power switch is set to **< OFF >**, for example, and the setting is changed to **[Disable]**.
- Even if a flash is used, it will not fire.
- The following operations cancel standby for time-lapse movie recording and switch the setting to **[Disable]**.
 - Selecting either **[Clean now]** in **[Sensor cleaning]** or **[Basic settings]** in **[Reset camera]**
- Image quality may be lower if you start time-lapse movie recording while a white  or red  icon () is displayed. For best results, before recording, wait until the white  or red  icon is no longer displayed, which indicates that the camera has cooled down.
- With **[Auto exposure]** set to **[Each frame]**, the ISO speed, shutter speed, and aperture value may not be recorded in the time-lapse movie Exif information in some shooting modes.



Note

- You can use Wireless Remote Control BR-E1 (sold separately) to start and stop time-lapse movie recording.

With Wireless Remote Control BR-E1

- First, pair Wireless Remote Control BR-E1 with the camera ()
- Set **[Remote control]** to **[Enable]**.
- After you take some test shots and the camera is ready to shoot (as in step 13, ) , set the release timing/movie shooting switch on the BR-E1 to **<●>** (immediate release) or **<2>** (2-sec. delay).
- If the remote control's switch has been set to **<Movie Recording icon>**, the time-lapse movie recording cannot start.

Camera Status/Remote Control Setting	<●> Immediate Release <2> 2-sec. Delay	<Movie Recording icon> Movie Recording
Test-recording screen	Test recording	To recording standby
Recording standby	Starts recording	To test-recording screen
During time-lapse movie recording	Ends recording	Ends recording

Approx. Time Available for Recording Time-Lapse Movies

For guidelines on how long you can record time-lapse movies (until the battery runs out), see [Movie recording](#).

Movie Self-Timer

Movie recording can be started by the self-timer.

1. Select [: Movie self-timer].

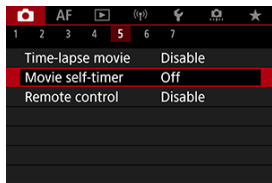

2. Select an option.

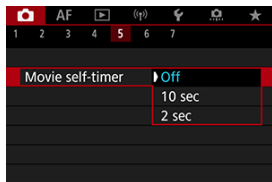

3. Record the movie.

- After you press the movie shooting button or tap [], the camera displays the number of seconds left before recording and beeps.

Note

- To cancel the self-timer, either tap the screen or press the < > button.

Image Stabilizer (IS Mode)

 [IS Mode](#)

 [Movie Digital IS](#)

The camera's IS mode and movie digital IS features reduce camera shake as movies are recorded. They can provide effective stabilization even when non-IS lenses are used. The **[IS mode]** menu item is not shown when IS-equipped lenses are used. In that case, setting the lens Image Stabilizer switch to < **ON** > combines stabilization by the lens and camera.

IS Mode

1. Select [: IS (Image Stabilizer) mode].

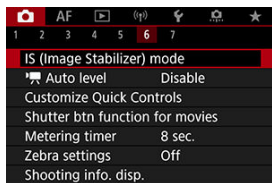

2. Select [IS mode].

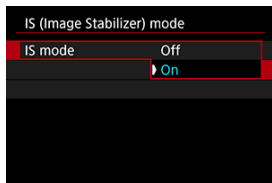

- Select [**On**] to use IS mode on the camera.

1. Select [📷: IS (Image Stabilizer) mode].

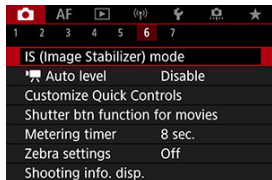

2. Select a [📷 Digital IS] option.

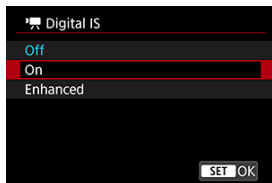

- **Off** (📷 Off)
Image stabilization with Movie digital IS is disabled.
- **On** (📷 On)
Camera shake will be corrected. The image will be slightly magnified.
- **Enhanced** (📷 Enhanced)
Compared to when [On] is set, stronger camera shake can be corrected. The image will be more magnified.

Caution

- Movie digital IS will not function when the lens's optical Image Stabilizer switch is set to < OFF >.
- With non-IS lenses, setting [ Digital IS] to [On] or [Enhanced] also sets [IS mode] to [On].
- Stabilization by Movie digital IS may be less effective at some movie recording sizes.
- The wider the angle of view (wide angle), the more effective the image stabilization will be. The narrower the angle of view (telephoto), the less effective the image stabilization will be.
- When using a tripod, setting Movie digital IS to [Off] is recommended.
- Depending on the subject and shooting conditions, the subject may blur noticeably (the subject momentarily looks out of focus) due to the effects of the Movie digital IS.
- Consider setting to [Off] when using a TS-E lens or fish-eye lens.
- Since Movie digital IS magnifies the image, the image looks more grainy. Noise, dots of light, etc. may also become noticeable.

Note

- For details on configuring image stabilization for still photo shooting, see [Image Stabilizer \(IS Mode\)](#).
- With some lenses, even more effective stabilization (indicated by "+" next to the IS icon) is possible when the lens's IS is used in conjunction with IS on the camera. For details on lenses compatible with this feature, visit the Canon website ([@](#)).

Shutter Button Function for Movies

You can set the functions performed by pressing the shutter button halfway or completely during movie recording.

1. Select [: Shutter btn function for movies].

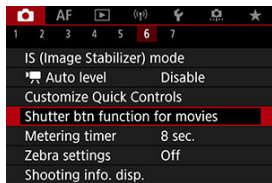

2. Select an option.

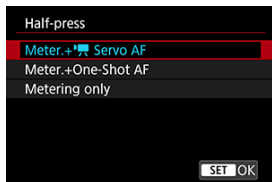

- **Half-press**
Specify the function performed by pressing the shutter button halfway.
- **Fully-press**
Specify the function performed by pressing the shutter button completely.

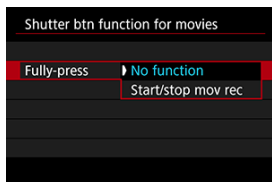

With **[Fully-press]** set to **[Start/stop mov rec]**, you can start/stop movie recording not only with the movie shooting button but also by pressing the shutter button completely, or by using Remote Switch RS-60E3 (sold separately).

To help you adjust exposure before or during movie recording, you can display a striped pattern over or around image areas of a specified brightness.

1. Select [**☑**: Zebra settings].

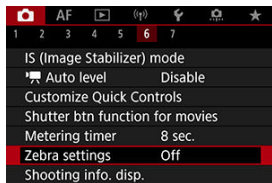

2. Select [**Zebra**].

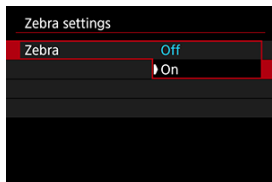

- Select [**On**].

3. Select [Zebra pattern].

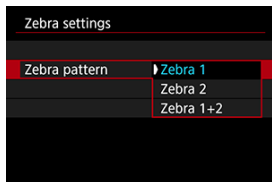

- [Zebra 1]: Displays left-slanting stripes around areas of the specified brightness.
- [Zebra 2]: Displays right-slanting stripes over areas that exceed the specified brightness.
- [Zebra 1+2]: Displays both [Zebra 1] and [Zebra 2]. [Zebra 1] display takes precedence where [Zebra 1] and [Zebra 2] display areas overlap.

4. Set the level.

Zebra 1 level

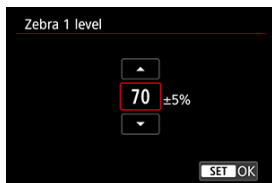

Zebra 2 level



- Turn the <  > dial to set it.



Note

- The maximum brightness value does not reach 100% when HDR-PQ is set. Note that the maximum brightness value varies depending on [📷: **Highlight tone priority**] and [📷: **Picture Style**] settings.
- The maximum brightness value does not reach 100% when Canon Log is set.
- Checking the zebra display level in advance is recommended when you will set [Zebra pattern].

Time Code

- [Count Up](#)
- [Start Time Setting](#)
- [Movie Recording Count](#)
- [Movie Play Count](#)
- [HDMI](#)
- [Drop Frame](#)

Time codes record the time automatically as movies are recorded. Time codes always record elapsed hours, minutes, seconds, and frames. They are mainly used when movies are edited.

To set up the time code, use [: **Time code**].

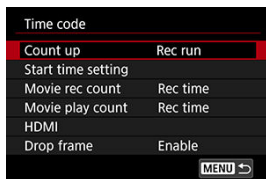

Caution

- Time codes may not be displayed correctly if your movies are played back on devices other than the camera.

Count Up

- **Rec run**

The time code advances only during movie recording. Time codes in each movie file recorded continue from the last time code in the previous file.

- **Free run**

The time code keeps advancing, even when you are not recording.

Caution

- When set to **[Free run]**, time codes are not added to movies recorded with the camera configured for High Frame Rate, time-lapse, or Creative filter recording.
- When set to **[Free run]**, time codes will be affected by any changes to settings for time, zone, or daylight saving time (🕒).

Start Time Setting

You can set the initial time of the time code.

- **Manual input setting**
Enables you to set any starting hour, minute, second, and frame.
- **Reset**
Resets the time set with **[Manual input setting]** or **[Set to camera time]** to "00:00:00."
or "00:00:00:" (⌚).
- **Set to camera time**
Matches the hour, minute, and second set as the time on the camera. Sets the frame value to "00."

Movie Recording Count

You can select how time is displayed on the movie recording screen.

- **Rec time**

During recording standby, displays the available recording time. During recording, displays the time that has elapsed since movie recording began (1).

- **Time code**

Displays the time code during movie recording (2).



Movie Play Count

You can select how time is displayed on the movie playback screen.

- **Rec time**
Displays the recording or playback time during movie playback.
- **Time code**
Displays the time code during movie playback.



Note

- Time codes are always recorded to movie files (except when High Frame Rate movies are set to **[Free run]**), regardless of the **[Movie rec count]** setting.
- The **[Movie play count]** setting in **[📷: Time code]** is linked to the **[▶]: Movie play count]**, so that these settings always match.
- The “frame” count is not displayed during movie recording or playback.

HDMI

● Time code

Time codes can be added to movies as you record them to an external device via HDMI.

• Off

No time code is added to HDMI video output.

• On

Time codes are added to HDMI video output. When **[On]** is set, **[Rec Command]** is displayed.

● Rec Command

For HDMI video output recorded by an external device, you can synchronize recording to when you start and stop recording movies on the camera.

• Off

Recording is started and stopped by the external device.

• On

Recording by an external device is synchronized to starting/stopping recording on the camera.



Caution

- Time codes are not added to HDMI video output when you record High Frame Rate movies with **[Count up]** in **[Time code]** set to **[Free run]**.
- To determine compatibility of external recording devices with **[Time code]** and **[Rec Command]** functions, check with the device manufacturer.
- Even with **[Time code]** set to **[Off]**, external recording devices may add time codes to movies, depending on their specifications. For details on device specifications relevant to adding time code to HDMI input, check with the device manufacturer.

Drop Frame

The time code's frame count will cause a discrepancy between the actual time and the time code if the frame rate is set to **119.9P** (119.9 fps), **59.94P** (59.94 fps), or **29.97P** (29.97 fps). The discrepancy is corrected automatically when **[Enable]** is set.

- **Enable**

Corrects the discrepancy automatically by skipping time code numbers (DF: drop frame).

- **Disable**

The discrepancy is not corrected (NDF: non-drop frame).
Time codes are displayed as follows.

- **Enable (DF)**

00:00:00. (Playback: 00:00:00.00)

- **Disable (NDF)**

00:00:00. (Playback: 00:00:00.00)



Note

- The **[Drop frame]** setting item is not displayed when the frame rate is set to **23.98P** (23.98 fps), or when **[Video system]** is set to **[For PAL]**.

Other Menu Functions



● Exposure comp.

Exposure compensation can be adjusted in a range of ± 3 stops, in 1/3-stop increments. For details on exposure compensation, see [Manual Exposure Compensation](#).

● ISO speed settings





• ISO speed

In [M] mode, you can set the ISO speed manually. You can also select ISO Auto.





• ISO speed range

You can set the manual ISO speed setting range (minimum and maximum). ISO expansion can also be configured.

• Max for Auto

You can set the maximum limit for ISO Auto in movie recording in [P], [Tv], or [Av] mode or in [M] mode with ISO Auto.

• Max for Auto

You can set the maximum limit for ISO Auto in 4K time-lapse/Full HD time-lapse movie recording in [P], [Tv], or [Av] mode or in [M] mode with ISO Auto. By default, the maximum limit is set to ISO 12800. The maximum limit can be set in a range of ISO 400–25600.

- **HDR shooting** **HDR PQ**

For details on **HDR shooting** **HDR PQ**, see [HDR Shooting](#).

- **Auto Lighting Optimizer**



Brightness and contrast can be corrected automatically. For details on Auto Lighting Optimizer, see [Auto Lighting Optimizer](#).

- **Highlight tone priority**

You can reduce overexposed, clipped highlights as you record movies. For details on Highlight tone priority, see [Highlight Tone Priority](#).



- ** Av 1/8-stop incr.**

- You can set aperture values on a finer scale when recording movies with an RF lens.

This feature is available when the camera is set to [M] or [Av].

Select **[Enable]** to change the aperture increment from 1/3 stop (or 1/2 stop) to 1/8 stop.



 **Caution**

- [Av 1/8-stop incr.] is not available (not displayed) when EF or EF-S lenses are used.
- When set to **[Enable]**, setting options in [: **Exposure level increments**] are disabled and have no effect.

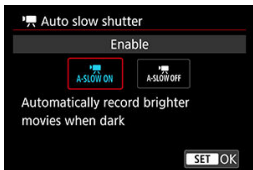
● Auto slow shutter



You can choose whether to record movies that are brighter and less affected by image noise than when set to **[Disable]** by automatically slowing the shutter speed under low light.

Available in  or  recording mode. Applies when the frame rate of the movie recording size is **59.94P** or **50.00P**.

- **Disable**

Enables you to record movies with smoother, more natural movement, less affected by subject shake than when set to **[Enable]**. Note that under low light, movies may be darker than when set to **[Enable]**.

- **Enable**

Enables you to record brighter movies than when set to **[Disable]** by automatically reducing the shutter speed to 1/30 sec. (NTSC) or 1/25 sec. (PAL) under low light.

Note

- Setting to **[Disable]** is recommended when recording moving subjects under low light, or when afterimages such as trails may occur.

- **White balance**

For details on white balance, see [White Balance](#).

- **Custom White Balance**

For details on custom white balance, see [Custom White Balance](#).

- **WB correction**

For details on white balance correction, see [White Balance Correction](#).

- **Picture Style**

For details on Picture Styles, see [Picture Style Selection](#).

- **Clarity**

For details on clarity, see [Clarity](#).

- **Lens aberration correction**

Peripheral illumination correction, distortion correction, and chromatic aberration correction can be corrected as you record movies. For details on lens aberration correction, see [Lens Aberration Correction](#).

- **High ISO speed NR**

For details on High ISO speed noise reduction, see [High ISO Speed Noise Reduction](#).

- **Remote control**

By setting to **[Enable]**, you can start or stop movie recording using Wireless Remote Control BR-E1 (sold separately).

- **Auto level**

For details on Auto level, see [Auto Level](#).

- **Customize Quick Controls**

For details on customizing Quick Controls, see [Customizing Quick Controls](#).

- **Metering timer**

For details on the metering timer, see [Metering Timer](#).

- **Shooting info. disp.**

For details on configuring shooting information display, see [Shooting Information Display](#).

- **Reverse display**

For details on reverse display, see [Reverse Display](#).

- **VF display format**

For details on the viewfinder display format, see [Viewfinder Display Format](#).

- **Standby: Low res.**

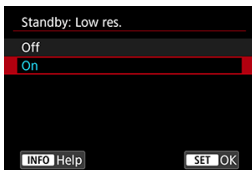

Set to **[On]** to conserve battery power and control the rise of camera temperature during standby.

As a result, it may enable you to record movies over a longer period.

⚠ Caution

- Image quality on the standby screen may differ from image quality on the screen during movie recording.
- Briefly when you start recording movies, image display may remain on the current frame instead of being updated.
- With digital zoom set to an option other than **[Disable]**, overheat control is set to **[Off]** and cannot be changed (🔒).

● HDMI display

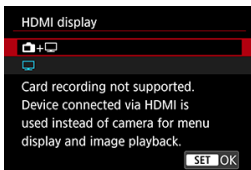

You can specify how movies are displayed as they are recorded via HDMI to an external device. Movie output itself corresponds to the **[Movie rec. size]** setting.

The default setting is **[HDMI only]**.

- **Camera + HDMI**
Enables movie display both on the camera screen and on the other device, via HDMI output.
Camera operations such as image playback or menu display are shown on the other device via HDMI, not on the camera screen.
- **HDMI only**
Deactivates the camera screen during output via HDMI, so that the screen is blank. Shooting information, AF points, and other information is shown on the external device via HDMI, but you can stop output of this information by pressing the **<INFO>** button.
Before recording movies externally, confirm that no information is being sent by the camera by making sure no shooting information, AF points, and so on is displayed on external monitors or other devices.

! Caution

- Card recording is not performed with **[HDMI display]** set to **Camera + HDMI**. Camera menus and image playback are only displayed on the screen connected via HDMI.
- The HDMI output resolution and frame rate are automatically adjusted to suit the movie recording size.

? For longer HDMI output

To continue HDMI output for longer than 30 min., select **Camera + HDMI**, then set **[Auto power off]** in **[Power saving]** to **[Disable]** (☑). HDMI output will continue after the camera screen turns off when the time set in **[Screen off]** elapses.

 **Caution**

- HDMI output without information prevents display of warnings about the card space, battery level, or high internal temperature (🔒) via HDMI.
- During HDMI output, display of the next image may take some time if you switch between movies of different recording sizes or frame rates.
- Avoid operating the camera when recording movies to external devices, which may cause information to be displayed in the HDMI video output.
- Brightness and color of movies recorded with the camera may look different from that of HDMI video output recorded by external devices, depending on the viewing environment.

 **Note**

- By pressing the <INFO> button, you can change the information displayed.
- Time codes can be added to HDMI video output (🔒).
- Audio is also output via HDMI, except when [Sound rec.] is set to [Disable].

General Movie Recording Precautions

[Warning Indicator Display in Movie Recording](#)

Warning Indicator Display in Movie Recording

A 10-level indicator (1) is displayed during movie recording in case of excessive internal camera temperature.



As the internal temperature rises, the level on the indicator extends to the right. How fast the level increases will depend on shooting conditions. Levels 1–7 are marked in white, but once the temperature reaches level 8, the color changes.



[P] flashes in red if you continue recording after the indicator reaches level 9, marked in orange. A flashing icon indicates that the camera will soon turn off automatically.



A message is displayed if you continue to record while the icon is flashing, and the camera automatically turns off.

- **Subsequent recording**

To keep recording under the same settings, leave the camera off and let it cool down a while. Note that the camera may overheat again after you resume recording.

Precautions for movie recording

- Do not point the camera toward an intense light source, such as the sun or an intense artificial light source. Doing so may damage the image sensor or the camera's internal components.
- If you record something that has fine detail, moire or false colors may result.
- If [AWB] or [AWBW] is set and the ISO speed or aperture value changes during movie recording, the white balance may also change.
- If you record a movie under fluorescent or LED lighting, the movie image may flicker.
- If you perform AF with a USM lens during movie recording in low light, horizontal banding noise may be recorded in the movie. The same type of noise may occur if you focus manually with certain lenses equipped with an electronic focusing ring.
- Recording a few test movies is recommended if you intend to perform zooming during movie recording. Zooming as you record movies may cause exposure changes or lens sounds to be recorded, an uneven audio level, inaccurate lens aberration correction, or loss of focus.
- Large aperture values may delay or prevent accurate focusing.
- Performing AF during movie recording may cause the following kinds of issues: significant temporary loss of focus, recording of changes in movie brightness, temporary stopping of movie recording, or recording of mechanical lens sounds.
- Avoid covering the built-in microphones with your fingers or other objects.
- Connecting or disconnecting an HDMI cable during movie recording will end recording.
- If necessary, also see [General Still Photo Shooting Precautions](#).
- The camera may become hot in movie recording while connected via Wi-Fi. Use a tripod or take other measures to avoid handheld recording.

Recording and image quality

- If the attached lens has an Image Stabilizer and you set the Image Stabilizer switch to <ON>, the Image Stabilizer will operate at all times even if you do not press the shutter button halfway. This will consume battery power, and it may reduce the total movie recording time. When the Image Stabilizer is not necessary, such as when using a tripod, it is recommended that you set the Image Stabilizer switch to <OFF>.
- If the brightness changes as you record a movie with auto exposure, the movie may appear to stop momentarily. In this case, record movies with manual exposure.
- If there is a very bright light source in the image, the bright area may appear black on the screen. Movies are recorded almost exactly as they appear on the screen.
- Image noise or irregular colors may occur when shooting at high ISO speeds, high temperatures, slow shutter speeds, or under low light. Movies are recorded almost exactly as they appear on the screen (except with [ **Canon Log settings**] set to [View Assist.]).
- Video and audio quality of recorded movies may be worse on other devices, and playback may not be possible, even if the devices support MP4 formats.



- If you use a card with a slow writing speed, an indicator may appear on the right of the screen during movie recording. The indicator shows how much data has not yet been written to the card (remaining capacity of the internal buffer memory), and it increases more quickly the slower the card is. If the indicator (1) becomes full, movie recording will stop automatically.



- If the card has a fast writing speed, the indicator will not appear or the level (if displayed) will not increase much. First, record a few test movies to see if the card can write fast enough.
- If the indicator shows that the card is full, and movie recording stops automatically, the sound near the end of the movie may not be recorded properly.
- If the card's writing speed is slow (due to fragmentation) and the indicator appears, formatting the card may make the writing speed faster.

Note

Notes for movie recording

- Each time you record a movie, a new movie file is created on the card.
- Field of view (coverage) is approx. 100%.
- Focusing is also possible by pressing the < AF-ON > button.
- To enable starting/stopping movie recording by pressing the shutter button completely, set [Fully-press] for [ Shutter btn function for movies] to [Start/stop mov rec] ().
- Most external microphones compatible with 3.5 mm mini-jacks can be used.
- Any connected external microphone is used instead of the built-in microphone.
- Focus preset during movie recording is available when using (super) telephoto lenses equipped with this function released in and after the second half of 2011.
- YCbCr 4:2:0 (8-bit) color sampling and the BT.709 color space are used for 4K and Full HD movies.

AF/Drive

This chapter describes autofocus operation and drive modes and introduces menu settings on the AF [**AF**] tab.

☆ to the right of titles indicates functions only available in < **Fv** >, < **P** >, < **Tv** >, < **Av** >, < **M** >, or < **B** > mode.

Note

- < **AF** > stands for autofocus. < **MF** > stands for manual focus.

- [Tab Menus: AF \(Still Photos\)](#)
- [Tab Menus: AF \(Movie Recording\)](#)
- [AF Operation](#) ☆
- [Movie Servo AF](#)
- [Selecting the AF Area](#) ☆
- [Preview AF](#)
- [Touch & Drag AF Settings](#)
- [Manual Focus](#)
- [Servo AF Characteristics](#) ☆
- [Customizing AF Functions](#) ☆
- [Selecting the Drive Mode](#)
- [Using the Self-Timer](#)
- [Remote Control Shooting](#)
- [Customizing Operation](#)

Tab Menus: AF (Still Photos)

- AF1

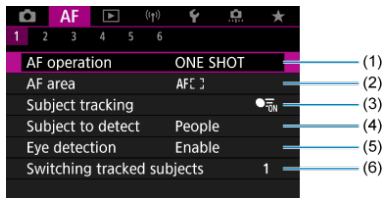

- (1) [AF operation](#)
- (2) [AF area](#)
- (3) [Subject tracking](#)
- (4) [Subject to detect](#)
- (5) [Eye detection](#)
- (6) [Switching tracked subjects](#)

Note

- When lenses without a focus mode switch are used, [Focus mode] is displayed on the [AF1] tab if you have set [🔍: ⏻ switch (AF/MF)] to [Disable] (🔒).

● AF2

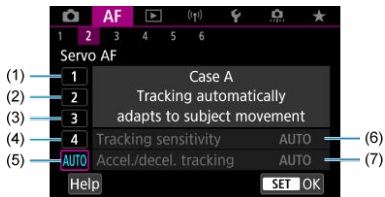

- (1) [Case 1](#)
- (2) [Case 2](#)
- (3) [Case 3](#)
- (4) [Case 4](#)
- (5) [Case A](#)
- (6) [Tracking sensitivity](#)
- (7) [Accel./decel. tracking](#)

● AF3

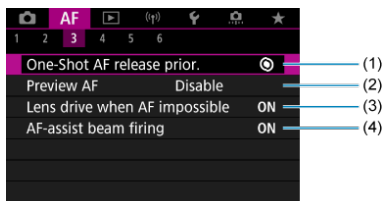

- (1) [One-Shot AF release prior.](#)
- (2) [Preview AF](#)
- (3) [Lens drive when AF impossible](#)
- (4) [AF-assist beam firing](#)

● AF4

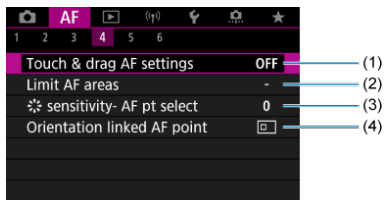

- (1) [Touch & drag AF settings](#)
- (2) [Limit AF areas](#)
- (3) [sensitivity- AF pt select](#)
- (4) [Orientation linked AF point](#)

● AF5

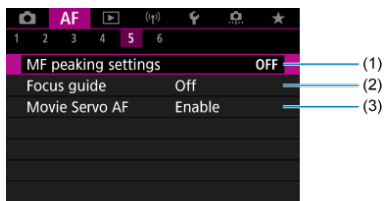

- (1) [MF peaking settings](#)
- (2) [Focus guide](#)
- (3) [Movie Servo AF](#)

● AF6

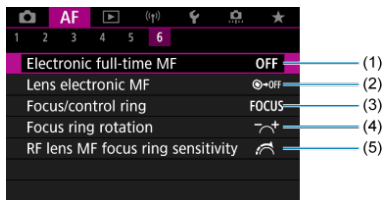

- (1) [Electronic full-time MF](#)
- (2) [Lens electronic MF](#)
- (3) [Focus/control ring](#)
- (4) [Focus ring rotation](#)
- (5) [RF lens MF focus ring sensitivity](#)

In Basic Zone modes, the following screens are displayed.
Note that available menus vary by shooting mode.

● AF1

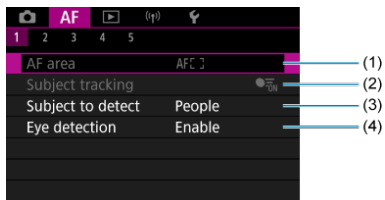

- (1) [AF area](#)
- (2) [Subject tracking](#)
- (3) [Subject to detect](#)
- (4) [Eye detection](#)

● AF2



- (1) [Preview AF](#)
- (2) [AF-assist beam firing](#)

● AF3

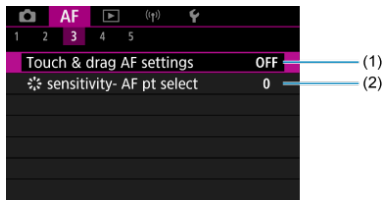

- (1) [Touch & drag AF settings](#)
- (2) [sensitivity- AF pt select](#)

● AF4

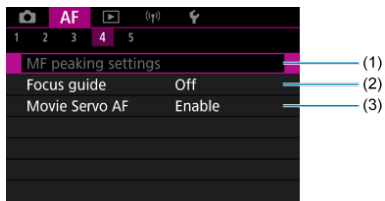

- (1) [MF peaking settings](#)
- (2) [Focus guide](#)
- (3) [Movie Servo AF](#)

● AF5

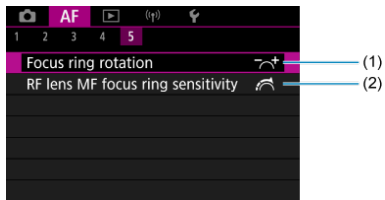

- (1) [Focus ring rotation](#)
- (2) [RF lens MF focus ring sensitivity](#)

Tab Menus: AF (Movie Recording)

● AF1

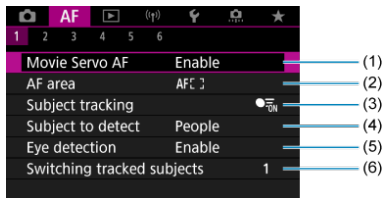

- (1) [Movie Servo AF](#)
- (2) [AF area](#)
- (3) [Subject tracking](#)
- (4) [Subject to detect](#)
- (5) [Eye detection](#)
- (6) [Switching tracked subjects](#)

Note

- When lenses without a focus mode switch are used, [Focus mode] is displayed on the [AF1] tab if you have set [🔊: ⚙️ switch (AF/MF)] to [Disable] (🔒).

● AF2

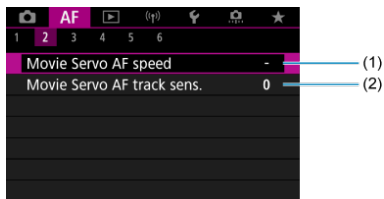

- (1) [Movie Servo AF speed](#)
- (2) [Movie Servo AF track sens.](#)

● AF3

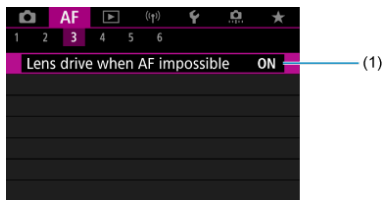

(1) [Lens drive when AF impossible](#)

● AF4

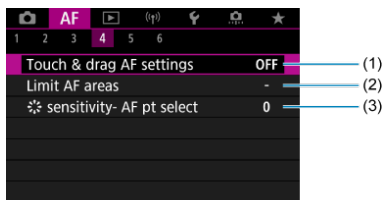

(1) [Touch & drag AF settings](#)

(2) [Limit AF areas](#)

(3) [sensitivity- AF pt select](#)

● AF5

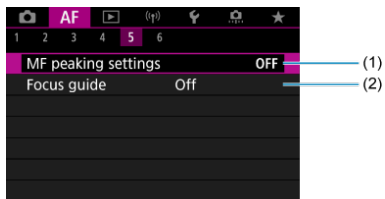

(1) [MF peaking settings](#)

(2) [Focus guide](#)

● AF6

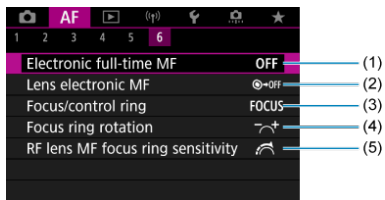

- (1) [Electronic full-time MF](#)
- (2) [Lens electronic MF](#)
- (3) [Focus/control ring](#)
- (4) [Focus ring rotation](#)
- (5) [RF lens MF focus ring sensitivity](#)

In Basic Zone modes, the following screens are displayed.
Available menus vary by shooting mode.

● AF1

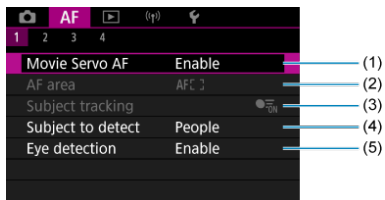

- (1) [Movie Servo AF](#)
- (2) [AF area](#)
- (3) [Subject tracking](#)
- (4) [Subject to detect](#)
- (5) [Eye detection](#)

● AF2

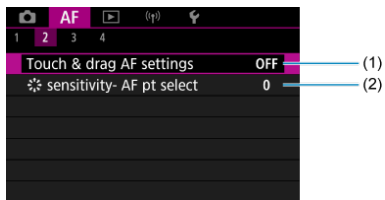

- (1) [Touch & drag AF settings](#)
- (2) [* sensitivity- AF pt select](#)

● AF3

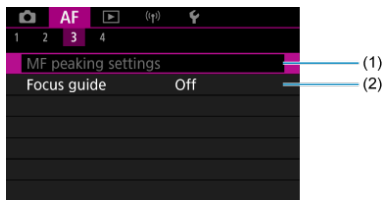

(1) [MF peaking settings](#)

(2) [Focus guide](#)

● AF4

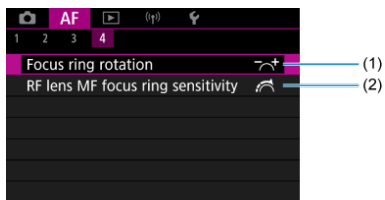

(1) [Focus ring rotation](#)

(2) [RF lens MF focus ring sensitivity](#)

AF Operation



[One-Shot AF for Still Subjects](#)

[Servo AF for Moving Subjects](#)



You can select the AF operation characteristics to suit the shooting conditions or subject.

1. Set the focus mode to (< AF >).

● For RF lenses without a focus mode switch

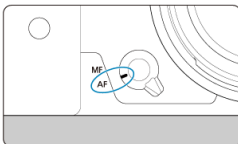
- With [ switch (AF/MF)] set to [Enable] (), set the focus mode switch on the front of the camera to < AF >.



- With [ switch (AF/MF)] set to [Disable] (), set [AF: Focus mode] to [AF].



● For RF lenses with a focus mode switch

Set the lens's focus mode switch to < AF >. The camera's focus mode switch is now disabled.

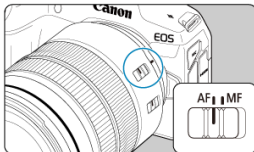

2. Select [AF: AF operation].

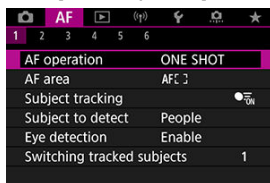

3. Select an option.

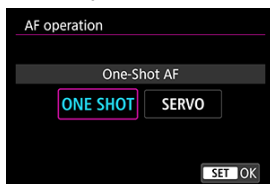

Note

- If focus is not achieved, the AF point will turn orange. When using One-Shot AF, either recompose the shot and try to focus again or see [Shooting Conditions That Make Focusing Difficult](#).
- With Servo AF, the camera shoots even when subjects are not in focus.

One-Shot AF for Still Subjects

This AF operation is suited for still subjects. When you press the shutter button halfway, the camera will focus only once.

- When focus is achieved, the AF point will turn green and the beeper will sound.
- The focus remains locked while you hold down the shutter button halfway, allowing you to recompose the image before taking the picture.
- For details on the continuous shooting speed for continuous shooting, see [Selecting the Drive Mode](#).

Note

- If [**Beeper**] is set to [**Disable**], the beeper will not sound when focus is achieved.
- See [Lens electronic MF](#) when using a lens that supports electronic manual focusing.

Shooting with the focus locked

In focus lock shooting, you will use One-Shot AF with a fixed AF point, then recompose the shot before shooting. The steps are as follows when you will press the shutter button halfway to focus.

1. Aim the fixed AF point over the subject to focus on, then press the shutter button halfway.

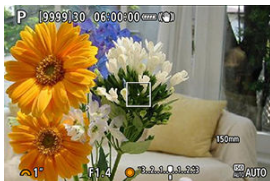

2. After the AF point in focus turns green, keep the shutter button pressed halfway and recompose the shot.



3. Press the shutter button completely to take the picture.

Servo AF for Moving Subjects

This AF operation is suited for moving subjects. While you hold down the shutter button halfway, the camera will keep focusing on the subject continuously.

- When focus is achieved, the AF point will turn blue. The beeper will not sound even when focus is achieved.
- The exposure is set at the moment the picture is taken.
- For details on the continuous shooting speed for continuous shooting, see [Selecting the Drive Mode](#).

Caution

- Accurate focusing may not be possible at high aperture values or depending on the lens, the distance to the subject, and how fast the subject is moving.
- Zooming during continuous shooting may throw off the focus. Zoom first, then recompose and shoot.
- Consider shooting with One-Shot AF if Servo AF operation is unsteady for still subjects.

Movie Servo AF

With this function enabled, the camera focuses on the subject continuously during movie recording.

1. Set the power switch to <  >.

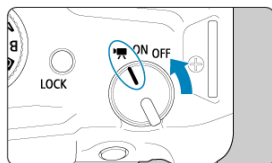

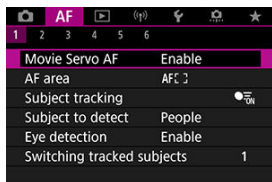

2. Select [**AF**: Movie Servo AF].

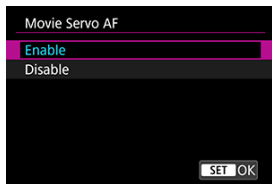

3. Select [Enable].



● Enable

- The camera focuses on the subject continuously even when you are not pressing the shutter button halfway.
- To keep the focus at a specific position, or if you prefer not to record mechanical sounds from the lens, you can temporarily stop Movie Servo AF by tapping [] in the lower left of the screen.
- Movie Servo AF will resume after pausing if you return to movie recording after operations such as pressing the < MENU > or <  > button or changing the AF area.

● Disable

While you hold down the shutter button halfway, the camera will keep focusing on the subject continuously. Pressing the < AF-ON > button focuses only once.

 Caution

Precautions when set to [Movie Servo AF: Enable]

- **Shooting conditions that make focusing difficult**
 - A fast-moving subject approaching or moving away from the camera.
 - A subject moving at a close distance to the camera.
 - When shooting with a higher aperture value.
 - Also see [Shooting Conditions That Make Focusing Difficult](#).
- Since the lens is driven continuously and the battery power is consumed, the possible movie recording time (🕒) will be shortened.
- The camera's built-in microphone may also record mechanical sounds of the lens or sounds of camera/lens operations if AF operations are performed or the camera or lens is operated during movie recording. In this case, using an external microphone may reduce these sounds. If the sounds are still distracting with an external microphone, it may be more effective to remove the external microphone from the camera and position it away from the camera and lens.
- Movie Servo AF pauses during zooming or magnified view.
- During movie recording, if a subject approaches or moves away or if the camera is moved vertically or horizontally (panning), the recorded image may momentarily expand or contract (change in image magnification).

Selecting the AF Area

- [AF Area](#)
- [Selecting the AF Area](#)
- [Subject Tracking](#)
- [Subject to Detect](#)
- [Eye Detection](#)
- [Switching Tracked Subjects](#)
- [Tracking with the Button](#)
- [Focus Mode](#)
- [Manually Setting AF Points \(or Zone AF Frames\)](#)
- [Magnified View](#)
- [AF Shooting Tips](#)
- [Shooting Conditions That Make Focusing Difficult](#)
- [AF Range](#)

AF Area

This section describes AF area operation with [**AF: Subject tracking**] set to [**Off**].

Spot AF

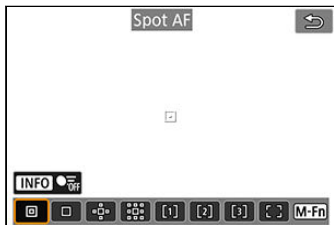

The camera focuses in a narrower area than 1-point AF.

1-point AF

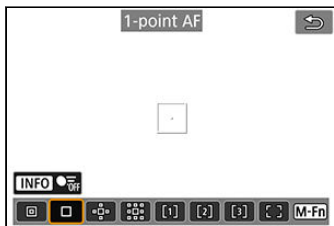

The camera focuses using a single AF point [].

Expand AF area:

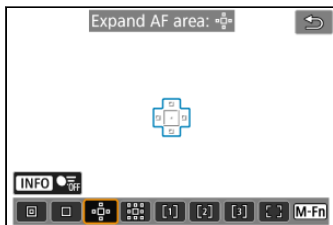



Focuses using one AF point  and the AF area outlined here in blue. Effective for moving subjects, which are difficult to track with 1-point AF.

Focusing on your preferred subject is easier than with Flexible Zone AF.

When Servo AF is used, first you will focus using an AF point .

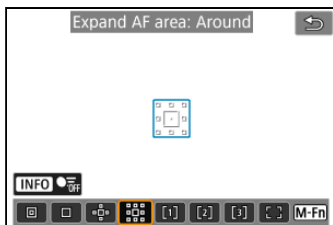
Expand AF area: Around



Focuses using one AF point  and the surrounding AF area outlined here in blue, which makes it easier to focus on moving subjects than with Expand AF area: .

When Servo AF is used, first you will focus using an AF point .

[1]: Flexible Zone AF 1

By default, a square Zone AF frame is set.

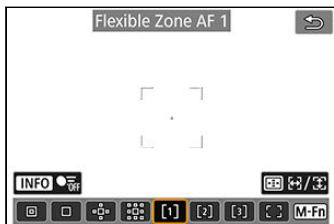

[2]: Flexible Zone AF 2

By default, a vertical rectangular Zone AF frame is set.

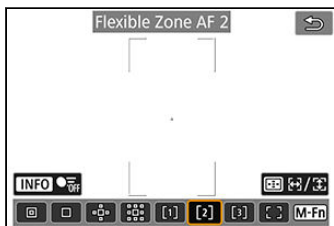

[3]: Flexible Zone AF 3

By default, a horizontal rectangular Zone AF frame is set.

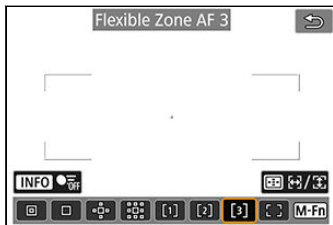

With Flexible Zone AF 1–3, you can freely set the size of the Zone AF frame (☞). Uses auto selection AF in Zone AF frames to cover a larger area than Expand AF area, which makes focusing easier than with 1-point AF/Expand AF area and effective for moving subjects.

Focusing areas are determined not only based on the nearest subject but also based on a variety of other conditions such as faces (of people or animals), vehicles, subject motion, and subject distance.

Pressing the shutter button halfway displays [☐] over AF points in focus.

[]: Whole area AF

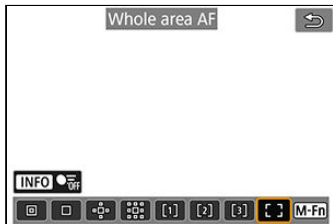

Uses auto selection AF in a whole-area AF frame to cover a larger area than Flexible Zone AF, which makes focusing easier than with 1-point AF/Expand AF area/Flexible Zone AF and effective for moving subjects.

Focusing areas are determined not only based on the nearest subject but also based on a variety of other conditions such as faces (of people or animals), vehicles, subject motion, and subject distance.

Pressing the shutter button halfway displays [☐] over AF points in focus.

Selecting the AF Area

You can select the AF area to suit the shooting conditions or subject. If you prefer to focus manually, see [Manual Focus](#).

1. Select [AF: AF area].

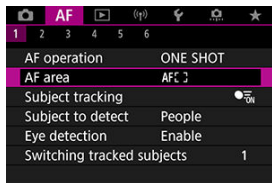



2. Select the AF area.



- The screen above is displayed when **[AF: Orientation linked AF point] (AF)** is set to **[Separate AF pts: Area+pt]**. Set separate AF areas after choosing vertical and horizontal orientations.



Note

- To set the AF area, you can also press the <  > button and then the < M-Fn > button.
- The following descriptions apply to the camera with AF operation set to [**One-Shot AF**] (). With [**Servo AF**] () set, the AF point will turn blue when focus is achieved.

Subject Tracking

Among the subjects detected, a tracking frame [] is displayed over the main subject. If the subject moves, the tracking frame [] also moves to track it.

You can set [**AF: Eye detection**] to [Enable] to shoot with the subject's eyes in focus ().

1. Select [**AF: Subject tracking**].

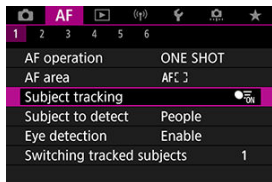

2. Select an option.

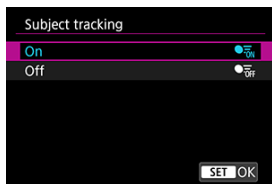

Caution

- No tracking frame is displayed when [**AF: Subject tracking**] is set to [Off], regardless of the [**AF: Subject to detect**] setting.

Manually selecting a subject for focus

1. Check the tracking frame.





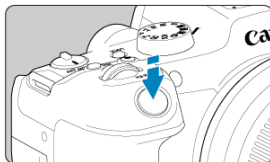

- A tracking frame [] appears over any subjects detected.
- Tracking frames [] away from AF points are displayed in gray.
- Once the tracked subject is near an AF point, even if it is outside the AF point, the tracking frame turns white (distinguishing it as an active frame), which enables selection as the main subject. The AF point turns gray.
- Gray display of tracking frames [] does not apply in movie recording.

2. Focus and shoot/record.



- Once you press the shutter button halfway and the subject is in focus, the AF point turns green and the camera beeps. An orange AF point indicates that the camera could not focus on subjects.

Note

- Selecting a subject by touch with [**AF: AF area**] set to [**Whole area AF**] changes the tracking frame to  and locks on to that subject for tracking across the entire screen.
- To release locked tracking, tap  [**OFF**].
- Pressing the shutter button halfway when the AF point does not overlap the tracking frame  will focus using the active, white AF frame.
- When AF operation is set to Servo AF, pressing the shutter button halfway focuses using Whole area AF.
- For human subjects, the active  may cover only a part of the face, not the whole face.
- The size of tracking frames varies depending on the subject.
- No tracking frame is displayed when [**AF: Subject tracking**] is set to [**Off**], regardless of the [**AF: Subject to detect**] setting.

Caution

- Tapping the screen to focus will focus with [**One-Shot AF**], regardless of the AF operation setting.
- If the subject's face is significantly out of focus, face detection will not be possible. Adjust the focus manually () so that the face can be detected, then perform AF.
- AF may not detect subjects or people's faces at the edges of the screen. Recompose the shot to center the subject or bring the subject closer to the center.

Subject to Detect

You can specify conditions for automatic selection of the main subject to track.

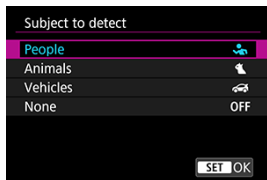

- **People**

Prioritizes the faces or heads of people as the main subjects to track.

When a person's face or head cannot be detected, the camera attempts to detect and track their torso. If their torso cannot be detected, the camera may track other parts of their body.

- **Animals**

Detects animals (dogs, cats, or birds) and people and prioritizes detection results for animals as the main subjects to track.

For animals, the camera attempts to detect faces or bodies, and a tracking frame is shown over any face detected.

When an animal's face or entire body cannot be detected, the camera may track part of their body.

- **Vehicles**

Detects two- or four-wheeled motorsports vehicles and people and prioritizes detection results for vehicles as the main subjects to track.

For vehicles, the camera attempts to detect key details or the entire vehicle, and a tracking frame is shown over any of these details detected.

If key details or the entire vehicle cannot be detected, the camera may track other parts of the vehicle.

Press the < **INFO** > button to enable or disable Spot detection for key details of vehicles.

- **None**

The camera determines the main subject automatically from how you compose shots, without detecting subjects.

Tracking frames are not displayed.

 **Caution**

- The camera may detect areas other than faces or bodies of people or animals or key details or bodies of vehicles as subjects.
- Faces that are very small or large in the picture, too bright or dark, or partly hidden cannot be detected.
- Animal face detection is not possible unless the subject is close enough and facing the camera steadily. A tracking frame is displayed for the entire body.
- Detection may not be possible for birds camouflaged in a forest, or similar situations.
- Detection may not be possible for ordinary passenger cars or bicycles, or for motorcyclists performing stunts or kicking up dirt and dust.
- No tracking frame is displayed when [**AF: Subject tracking**] is set to [**Off**], regardless of the [**AF: Subject to detect**] setting.

 **Note**

- When pressing the shutter button halfway for subject selection, you can choose the following subjects. In scenes without relevant subjects, the camera tracks other objects.
 - **People**
People, animals, vehicles
 - **Animals**
People, animals
 - **Vehicles**
People, vehicles

Eye Detection

You can shoot with the eyes of people or animals in focus.

1. Select **[AF: Eye detection]**.

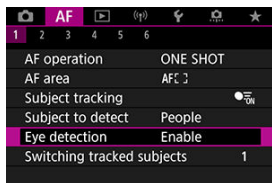

2. Select an option.

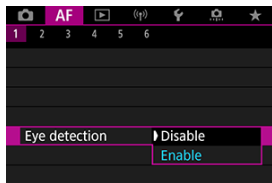

3. Aim the camera at the subject.



- A tracking frame is displayed around their eye.
- To choose an eye to focus on when **[AF: AF area]** is set to **[Whole area AF]**, either tap the screen or use < * >. As you use < * >, the tracking frame changes again to [*].
- You can also tap the screen to choose an eye, when **[AF: AF area]** is set to **[Whole area AF]** or during tracking in progress.
- If your selected eye is not detected, an eye to focus on is selected automatically.

4. Take the picture.

! Caution

- Subject eyes may not be detected correctly, depending on the subject and shooting conditions.
- No tracking frame is displayed when **[AF: Subject tracking]** is set to **[Off]**, even if **[AF: Subject to detect]** is set to an option other than **[None]**.
- Eyes are not detected when **[AF: Subject to detect]** is set to **[None]**.

Switching Tracked Subjects

You can specify how easily the camera switches AF points to track subjects.

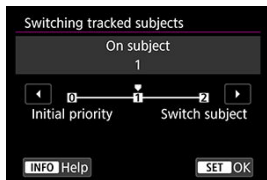



- **Initial priority**
Tracks the subject initially determined for AF, to the extent possible.
- **On subject**
Tracks the subject initially determined for AF, to the extent possible. Switches to other subjects if the camera can no longer determine if the tracked subject is the main subject.
- **Switch subject**
Switches to track other subjects in response to shooting conditions.

! Caution

Precautions when set to [Initial priority]

- The camera may not be able to continue tracking subjects under some subject conditions.
 - If subjects move vigorously
 - If subjects face a different direction or change their posture
 - If the tracking frame strays from subjects, or if subjects are hidden behind obstructions and you can no longer see them
- Subjects selected by touch operations are tracked to the extent possible, regardless of the [Subject to detect] setting.

Tracking with the Button

You can press a button assigned to **[Start/stop tracking]** in **[Customize buttons]** to track subjects with a tracking frame . This example is based on assigning the **< AF-ON >** button .

1. Check the AF point.





(1)

- The AF point (1) will appear.
- With Expand AF area:  or Expand AF area: Around, adjacent AF points are also displayed.
- With Flexible Zone AF, the specified Zone AF frame is displayed.

2. Press the **< AF-ON >** button.



- The AF point changes to a tracking frame , which locks on to that subject for tracking and follows the subject within the screen if it moves. To cancel tracking, press the **< AF-ON >** button again.
- The tracking frame changes to  when multiple subjects can be detected, and you can use **<  >** to choose a subject to focus on.
- Once tracking begins, the subject is tracked across the entire screen, regardless of the specified AF area.

3. Take the picture.



Note

- AF areas and points return to the position before tracking when tracking stops after you press the shutter button halfway or completely, or in shooting standby (when **[Servo AF]** is used).

Focus Mode

You can set how the camera focuses.

1. Select **[AF: Focus mode]**.

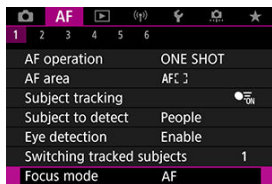

2. Select an option.



- **AF**
The camera operates in autofocus mode.
- **MF**
The camera operates in manual focus mode.

 Caution

- **[AF: Focus mode]** is not displayed under these conditions.
 - With [ switch (AF/MF)] set to [Enable]
 - When lenses with a focus mode switch are attached
 - When lenses designed exclusively for manual focusing are attached
 - When no lens is attached
 - When set to [MF], AF points are hidden during basic information display, and an MF icon is displayed.

Manually Setting AF Points (or Zone AF Frames)

You can manually set the AF point (or Zone AF frame). Screens such as these are shown when set to Flexible Zone AF 1.

1. Check the AF point or Zone AF frame.



(1)

- An AF point or Zone AF frame (1) appears.

2. Move the AF point or Zone AF frame.



- Use < ⌘ > to move the AF point or Zone AF frame into position for focusing (but note that with some lenses, it may not move to the edge of the screen).
- To center the AF point or Zone AF frame, press < ⌘ > straight in.
- You can also focus by tapping a position on the screen.
- To center the AF point or Zone AF frame, tap [⌘].
- You can resize Zone AF frames used for Flexible Zone AF by pressing the < [⌘] > button, followed by the < M-Fn > button, then the < [⌘] > button again. Adjust the width with the < [⌘] > dial, then height with the < [⌘] > dial, then press the < [⌘] > button. To restore the default Zone AF frame size, press the < INFO > button.

3. Focus and shoot/record.

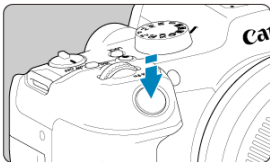

- Aim the AF point or Zone AF frame over the subject and press the shutter button halfway.



- When focus is achieved, the AF point or Zone AF frame will turn green and the beeper will sound.
- If focus is not achieved, the AF point or Zone AF frame will turn orange.

Caution



- The camera will keep moving the AF point [□] to track subjects when set to Flexible Zone AF and Servo AF, but under some shooting conditions (such as when subjects are small), it may not be possible to track the subject.
- Focusing may be difficult when using a peripheral AF point. In this case, select an AF point in the center.
- Tapping the screen to focus will focus with [One-Shot AF], regardless of the AF operation setting.

Note

- You can set AF areas and AF points when [AF: Orientation linked AF point] is set to [Separate AF pts: Area+pt] (☑).

Magnified View

To check the focus, you can magnify display by approx. 5× or 10× by tapping [Q].

- Magnification is centered on the AF point for [Spot AF], [1-point AF], [Expand AF area: , and [Expand AF area: Around], or on the Zone AF frame for Flexible Zone AF.
- Autofocusing is performed in magnified view if you press the shutter button halfway.
- When set to Servo AF, pressing the shutter button halfway in magnified view reverts to the normal view for focusing.
- Magnification is centered on the tracking frame when [AF: Subject tracking] is set to [Enable] and the tracking frame [] is white (as an active frame).

Caution

- If focusing is difficult in the magnified view, return to the normal view and perform AF.
- If you perform AF in the normal view and then use the magnified view, accurate focus may not be achieved.
- AF speed differs between the normal view and magnified view.
- Preview AF and Movie Servo AF are not available in magnified view.
- With the magnified view, achieving focus becomes more difficult due to camera shake. Using a tripod is recommended.

AF Shooting Tips

- Even when focus is achieved, pressing the shutter button halfway will focus again.
- Image brightness may change before and after autofocusing.
- Depending on the subject and shooting conditions, it may take longer to focus, or the continuous shooting speed may decrease.
- If the light source changes as you shoot, the screen may flicker, and focusing may be difficult. In this case, restart the camera and resume shooting with AF under the light source you will use.
- If focusing is not possible with AF, focus manually (☑).
- For subjects at the edge of the screen that are slightly out of focus, try centering the subject (or AF point, or Zone AF frame) to bring them into focus, then recompose the shot before shooting.
- With certain lenses, it may take more time to achieve focus with autofocus, or accurate focusing may not be achieved.

Shooting Conditions That Make Focusing Difficult

- Subject with low-contrast such as the blue sky, solid-color flat surfaces or when highlight or shadow details are clipped.
- Subjects in low light.
- Stripes and other patterns where there is contrast only in the horizontal direction.
- Subjects with repetitive patterns (Example: Skyscraper windows, computer keyboards, etc.).
- Fine lines and subject outlines.
- Under light sources with constantly changing brightness, colors, or patterns.
- Night scenes or points of light.
- The image flickers under fluorescent or LED lighting.
- Extremely small subjects.
- Subjects at the edge of the screen.
- Strongly backlit or reflective subjects (Example: Car with a highly reflective surfaces, etc.).
- Near and distant subjects covered by an AF point (Example: Animal in a cage, etc.).
- Subjects that keep moving within the AF point and will not stay still due to camera shake or subject blur.
- Performing AF when the subject is very far out of focus.
- Soft focus effect is applied with a soft focus lens.
- A special effect filter is used.
- Noise (dots of light, banding, etc.) appears on the screen during AF.

AF Range

The available autofocus range varies depending on the lens used and settings that control the aspect ratio, image quality, 4K movie recording, and Movie digital IS.

Preview AF

This function keeps subjects generally in focus. The camera is ready to focus immediately when you press the shutter button halfway.

1. Select [AF: Preview AF].

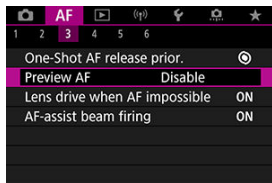

2. Select [Enable].

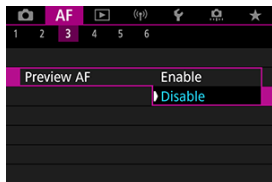

Caution

- Fewer shots are available when set to **[Enable]**, because the lens is driven continuously and battery power is consumed.

Touch & Drag AF Settings

- [Touch & Drag AF](#)
- [Positioning Method](#)
- [Active Touch Area](#)

You can move the AF point or Zone AF frame by tapping or dragging on the screen as you look through the viewfinder.

Touch & Drag AF

1. Select [: Touch & drag AF settings].

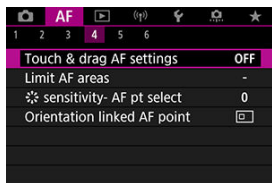

2. Select [Touch & drag AF].

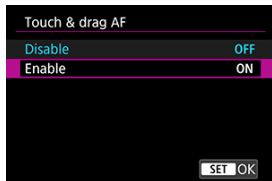

- Select [Enable].

Positioning Method

You can set how positions are specified by tapping or dragging.

1. Set [Positioning method].

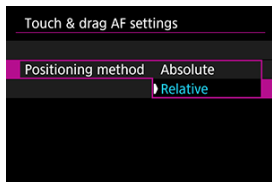

- **Absolute**
The AF point moves to the tapped or dragged position on the screen.
- **Relative**
The AF point moves in the direction you drag, by an amount corresponding to the amount you drag, no matter where you tap the screen.

Active Touch Area

You can specify the area of the screen used for tap and drag operations.

1. Select [Active touch area].

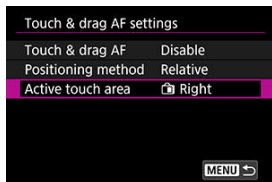

2. Set the area that will respond to touch.

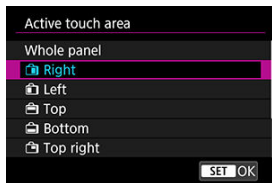

Note

- A round orange frame [⊂] is displayed when you tap the screen with [AF: AF area] set to [Whole area AF]. After you lift your finger at the position to move the AF point to, [⊂] is displayed and that subject is tracked. To cancel subject selection, tap [OFF].

Manual Focus

[☑ Setting MF peaking \(Outline Emphasis\)](#)

[☑ Focus Guide](#)

If focusing is not possible with autofocus, you can magnify the image and focus manually.

1. Set the focus mode to <MF>.

● For RF lenses without a focus mode switch

- With [**F**: **AF/MF** switch (AF/MF)] set to [Enable] (☑), set the focus mode switch on the front of the camera to <MF>.

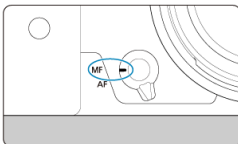

- With [**F**: **AF/MF** switch (AF/MF)] set to [Disable] (☒), set [**AF**: Focus mode] to [MF].



- **For RF lenses with a focus mode switch**

Set the lens's focus mode switch to <MF>. The camera's focus mode switch is now disabled.

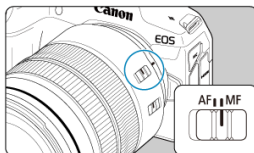

2. Magnify the image.



- Each tap of [Q] changes the magnification ratio, as follows.

→ x5 → x10 → x1 →

3. Move the magnified area.



- Use < * > to move the magnified area into position for focusing.
- To center the magnified area, press < * > straight in.

4. Focus manually.

- While looking at the magnified image, turn the lens focusing ring to focus.
- After focusing, tap [Q] to return to the normal view.



Note

- In magnified view, the exposure is locked.
- Even when focusing manually, you can use Touch Shutter to shoot.

Setting MF peaking (Outline Emphasis)

Edges of subjects in focus can be displayed in color to make focusing easier. You can set the outline color and adjust the sensitivity (level) of edge detection.

1. Select [**AF**: MF peaking settings].

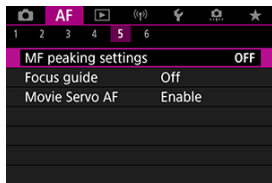

2. Select [**Peaking**].

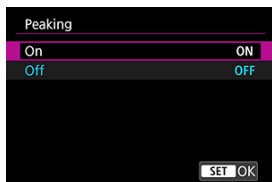

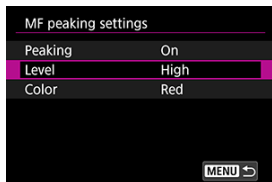

- Select [On].

3. Set [**Level**] and [**Color**].



- Set as necessary.

Caution

- In magnified view, peaking display is not shown.
- During HDMI output, peaking display is not shown on equipment connected via HDMI. Note that peaking display is shown on the camera screen when [: **HDMI display**] is set to [].
- MF peaking may be hard to discern at high ISO speeds, especially when ISO expansion is set. If necessary, lower the ISO speed or set [**Peaking**] to [**Off**].

Note

- Peaking display shown on the screen is not recorded in images.
- MF peaking may be hard to discern when Canon Log is set. If necessary, set [**View Assist.**] to [**On**].





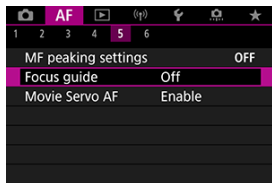

Setting [**AF: Focus guide**] to [**On**] provides a guide frame that shows which direction to adjust focus and the extent of adjustment needed.

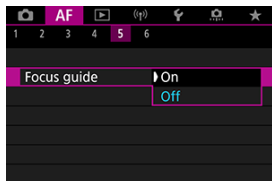
1. Select [**AF: Focus guide**].



2. Select [**On**].



- The guide frame is displayed on the face of any person detected as the main subject.
- To display the guide frame near the eyes of any person detected as the main subject, set [**AF: Subject tracking**] to [**Enable**] and [**AF: Eye detection**] to [**Enable**].
- After pressing the  button, you can use  to move the guide frame in the direction you press.
- To set the guide frame after moving it with , press the  button.
- You can also move and set the guide frame by tapping the screen.
- To center the guide frame, tap  or press  straight in.

The guide frame indicates the current position in focus and adjustment amount as follows.

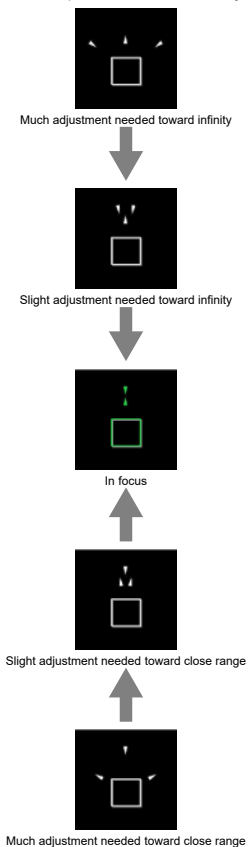

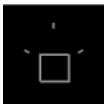

Adjustment information not detected

! Caution

- Under difficult shooting conditions for AF (AF-ON), the guide frame may not be displayed correctly.
- Higher aperture values are more likely to prevent correct guide frame display.
- No AF points are displayed while the guide frame is displayed.
- The guide frame is not displayed in these situations.
 - When the focus mode is set to < AF > on the camera or lens
 - When display is magnified
 - When digital zoom is set
- The guide frame is not displayed correctly during shifting or tilting of TS-E lenses.

📄 Note

- The camera's auto power off counter does not count time spent adjusting the focus with a lens's electronic focusing ring.

Servo AF Characteristics



- [☑ Case Details](#)
- [☑ Case 1: Versatile Multi-Purpose Setting](#)
- [☑ Case 2: Continue to Track Subjects, Ignoring Possible Obstacles](#)
- [☑ Case 3: Instantly Focus on Subjects Suddenly Entering AF Points](#)
- [☑ Case 4: For Subjects That Accelerate or Decelerate Quickly](#)
- [☑ Case A: Tracking Automatically Adapts to Subject Movement](#)
- [☑ Parameters](#)
- [☑ Adjusting Case Parameters](#)

Shooting with Servo AF can be easily tailored to your subjects or shooting situations by selecting a Case option. This feature is called the "AF Configuration Tool."

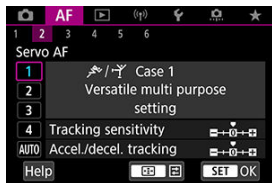
1. Select the [AF2] tab.







2. Select a case.

- Turn the <  > dial to select a case icon, then press the <  > button.
- Your selected case is now set. Selected cases are displayed in blue.
- To check help information, tap [Help].

Case Details

Case 1 to Case A are five combinations of settings for “[Tracking sensitivity](#)” and “[Acceleration/deceleration tracking](#).” Referring to the following table, select the case for your subject and shooting situation.

Case	Icon	Description	Examples of Shooting Situations
Case 1		Versatile multi purpose setting	Moving subjects in general
Case 2		Continue to track subjects, ignoring possible obstacles	Tennis, freestyle skiing
Case 3		Instantly focus on subjects suddenly entering AF points	Start of a cycling race, downhill skiing
Case 4		For subjects that accelerate or decelerate quickly	Soccer, rhythmic gymnastics, motorsports, basketball
Case A		Tracking automatically adapts to subject movement	Moving subjects in general, especially in dynamic shooting situations

Case 1: Versatile Multi-Purpose Setting

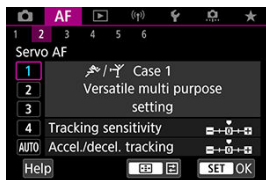

Default

- Tracking sensitivity: 0
- Accel./decel. tracking: 0

Standard setting suited to moving subjects in general. Suitable for many kinds of subjects and scenes.

In the following situations, select [Case 2] to [Case 4] instead: non-subjects moving across AF points, elusive subjects, or subjects that suddenly appear or change speed.

Case 2: Continue to Track Subjects, Ignoring Possible Obstacles

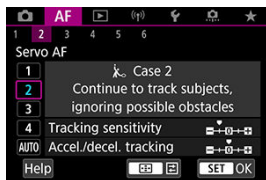

Default

- **Tracking sensitivity:** Locked on: -1
- **Accel./decel. tracking:** 0

Setting to continue focusing on the subject even if non-subjects move across AF points, or if the subject strays from AF points. Effective if you prefer the focus not to switch to non-subjects or the background.

Note

- Try setting [**Tracking sensitivity**] to [-2] if non-subjects tend to steal the focus or AF points tend to stray from the subject much of the time, preventing the camera from tracking the target subject under default settings (🔗).

Case 3: Instantly Focus on Subjects Suddenly Entering AF Points

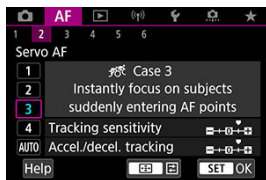

Default

- **Tracking sensitivity: Responsive: +1**
- **Accel./decel. tracking: +1**

Setting to focus on a series of subjects at different distances in the AF points, one after another. Focus switches to any new subject that appears in front of the target subject. Also effective when you want to always focus on the closest subject.

Note

- Try setting [**Tracking sensitivity**] to [**+2**] if you prefer focusing that immediately switches to new subjects that appear suddenly (👉).

Case 4: For Subjects That Accelerate or Decelerate Quickly

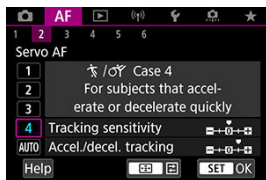

Default

- Tracking sensitivity: Responsive: 0
- Accel./decel. tracking: +1

Setting to keep tracking and focusing on subjects even if they suddenly change speed. Effective for subjects having sudden movements, sudden acceleration/deceleration, or sudden stops.

Note

- Try setting [Accel./decel. tracking] to [+2] to keep up with subjects that change speed significantly from moment to moment (🔗).

Case A: Tracking Automatically Adapts to Subject Movement

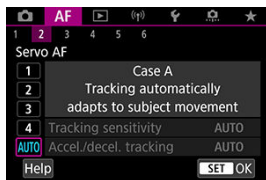

Useful when you prefer to shoot with parameters set automatically, based on how subjects change.

Tracking sensitivity and acceleration/deceleration tracking are set automatically.

Tracking sensitivity

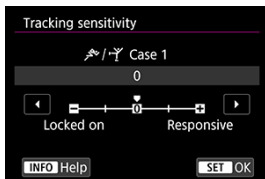

Setting for Servo AF subject-tracking sensitivity in response to non-subjects moving across AF points or subjects straying from AF points.

- **0**
Standard setting. Suitable for moving subjects in general.
- **Locked on: -2 / Locked on: -1**
The camera will try to continue focusing on the subject even if non-subjects move across AF points or if the subject strays from the AF points. The -2 setting makes the camera keep tracking the target subject longer than the -1 setting. However, if the camera focuses on a wrong subject, it may take slightly longer to switch and focus on the target subject.
- **Responsive: +2 / Responsive: +1**
The camera can focus consecutively on subjects at different distances that are covered by the AF points. Also effective when you want to always focus on the closest subject. The +2 setting is more responsive than the +1 setting when focusing on the next subject. However, the camera will be more prone to focus on an unintended subject.

Acceleration/deceleration tracking

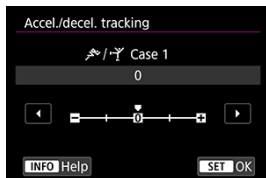

Setting for subject-tracking sensitivity in response to sudden, significant changes in speed, as when subjects suddenly start or stop moving.

- **0**
Suited for subjects that move at a steady speed (minor changes in moving speed).
- **-2 / -1**
Suited for subjects that move at a steady speed (minor changes in moving speed). Effective when a setting of 0 makes focus unstable, due to slight subject movement or an obstruction in front of the subject.
- **+2 / +1**
Effective for subjects having sudden movements, sudden acceleration/deceleration, or sudden stops. Even if the moving subject's speed suddenly changes significantly, the camera continues to focus on the target subject. For example, the camera is less likely to focus behind a subject that suddenly starts approaching you, or in front of an approaching subject that suddenly stops moving. Setting +2 can track dramatic changes in the moving subject's speed better than with +1.
However, since the camera will be sensitive to even slight movements of the subject, focusing may become unstable for short periods.

Adjusting Case Parameters

You can manually adjust the parameters ((1) Tracking sensitivity and (2) Acceleration/ deceleration tracking) for Case 1 to Case 4.

1. Select a case.

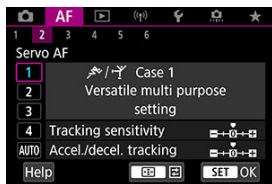

- Turn the <  > dial to select the number of a case to adjust.

2. Press the < > button.

- The selected parameter is outlined in purple.

3. Select a parameter to adjust.

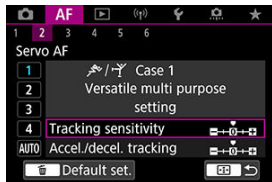

4. Make the adjustment.

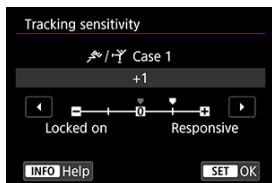

- Default settings are indicated by a light gray [] icon.
- To confirm the adjustment, press the < [] > button.
- To return to the screen in step 1, press the < [] > button.

Note

- To restore default parameter settings for (1) and (2) to each case, press the < [] > button in step 2, then press the < [] > button.
- You can also register (1) and (2) parameter settings to My Menu ([]). This enables you to adjust settings for the selected case.
- To shoot with a case you have adjusted, first select the adjusted case, then shoot.

Customizing AF Functions

☑ [\[AF3\]](#)

☑ [\[AF4\]](#)

☑ [\[AF6\]](#)

☑ [\[AF2\] \(In Movie Recording\)](#)

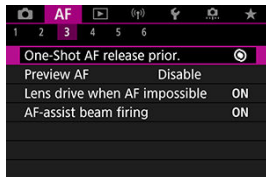

You can configure AF functions in detail to suit your shooting style or subject.

[AF3]

One-Shot AF release priority

You can specify whether to prioritize focus or release timing for One-Shot AF (except when shooting with Touch Shutter).

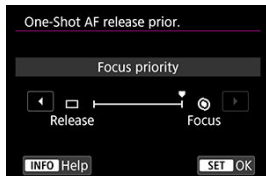

- **[⊙] Focus**

The picture will not be taken until focus is achieved. Useful when you want to achieve focus before capturing the image.

- **[□] Release**

Prioritizes shutter release over focus. Useful when capturing the decisive moment is most important.

Note that the camera shoots whether or not the subject is in focus.

Lens operation when AF is not available

You can specify lens operation that applies when autofocusing on a subject is not possible.

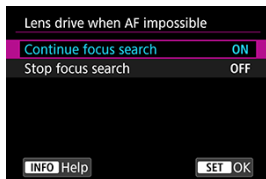

- **[ON] Continue focus search**

If focus cannot be achieved with autofocus, the lens is driven to search for the precise focus.

- **[OFF] Stop focus search**

If autofocus starts and the focus is far off or if focus cannot be achieved, the lens drive will not be performed. This prevents the lens from becoming grossly out of focus due to the focus search drive.

! Caution

- **[Stop focus search]** is recommended for super telephoto lenses or other lenses that are driven over a large focus area, to avoid significant delay from focus search drive if the lens becomes greatly out of focus.

AF-assist beam firing

You can enable or disable AF-assist beam firing of the camera or a Speedlite for EOS cameras.

1. Select **[AF: AF-assist beam firing]**.

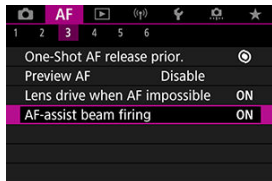

2. Select an option.

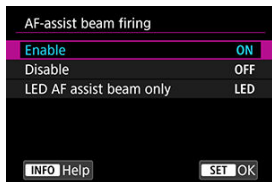

- **[ON] Enable**
Enables firing of the AF-assist beam, when needed.
- **[OFF] Disable**
Disables firing of the AF-assist beam. Set if you prefer not to fire the AF-assist beam.
- **[LED] LED AF assist beam only**
Enables LED AF-assist beam firing by Speedlites equipped with this feature, when these flash units are attached. If your Speedlite is not LED-equipped, the camera's AF-assist beam is fired instead.

! Caution

- Speedlite AF-assist beam firing is disabled when the Speedlite's **[AF: AF-assist beam firing]** Custom Function is set to **[Disable]**.

Limit AF areas

You can limit the AF areas available to the areas that you normally use. Select available AF areas and press the <  > button to add a checkmark [✓]. Select [OK] to register the setting. For details on AF areas, see [AF Area](#).

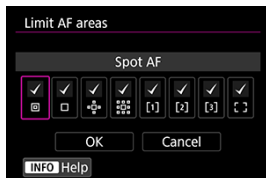

⚠ Caution

- The [✓] mark cannot be cleared from all items at the same time.

📄 Note

- An asterisk to the right of [**AF: Limit AF areas**] indicates that the default setting has been modified.

⚙ Multi-controller sensitivity in AF point selection

You can adjust Multi-controller sensitivity, which applies to AF point positioning.

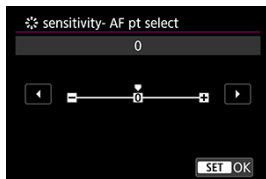

Orientation-linked AF points

You can set separate AF areas/points or separate AF point positions for vertical and horizontal shooting.

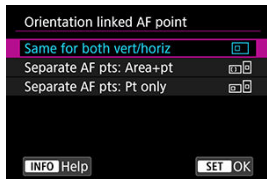

-  **Same for both vert/horiz**

The same AF points or Zone AF frames in the same AF areas are used in both vertical and horizontal shooting.

-  **Separate AF pts: Area+pt**

Separate types of AF areas or separate positions of AF points or Zone AF frames can be set for each camera orientation ((1) Horizontal, (2) Vertical with the camera grip up, (3) Vertical with the camera grip down ).

Useful when switching to other types of AF areas or positions of AF points or Zone AF frames automatically based on camera orientation.

AF areas and positions of AF points or Zone AF frames you assign to each of the three camera orientations are retained.

-  **Separate AF pts: Pt only**

Separate positions of AF points or Zone AF frames can be set for each camera orientation ((1) Horizontal, (2) Vertical with the camera grip up, (3) Vertical with the camera grip down). Useful when switching to other positions of AF points or Zone AF frames automatically based on camera orientation.

Positions of AF points or Zone AF frames you assign to each of the three camera orientations are retained.

Caution

- The default setting of [**Same for both vert/horiz**] is restored if you select [**Basic settings**] in [**Reset camera**] . Settings for orientations (1)–(3) are cleared, and the selected AF area option becomes [**Whole area AF**].
- The setting may be cleared if you switch lenses.

Electronic full-time MF

Operation of manual focus adjustment using the electronic focusing ring when certain lenses are attached is customizable. Check the Canon website for compatible lenses (🔗).



- **Disable**
Operation of manual focus adjustment corresponds to the [Lens electronic MF] setting.
- **Enable**
Manual focus adjustment is available whenever camera operations are possible.

Lens electronic MF

For lenses equipped with electronic manual focusing, you can specify how manual focus adjustment is used with One-Shot AF.

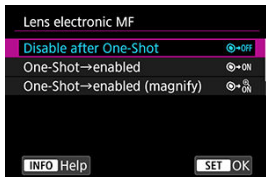

- **[📷→OFF] Disable after One-Shot**
After the AF operation, manual focusing adjustment is disabled.
- **[📷→ON] One-Shot→enabled**
You can manually adjust the focus after the AF operation if you keep holding down the shutter button halfway.

- **[ ON] One-Shot→enabled (magnify)**

You can manually adjust the focus after the AF operation if you keep holding down the shutter button halfway. You can magnify the area in focus and adjust the focus manually by turning the lens focusing ring.

- **[OFF] Disable in AF mode**

Manual focus adjustment is disabled when the focus mode switch of the camera or lens is set to < AF >.

 **Caution**

- With [**One-Shot→enabled (magnify)**], display may not be magnified even if you turn the lens focusing ring while pressing the shutter button halfway immediately after shooting. If so, you can magnify display by releasing the shutter button, waiting for [] display, then pressing the shutter button halfway as you turn the lens focusing ring.

 **Note**

- For details on your lens's manual focus specifications, refer to the Lens Instruction Manual.

Focusing ring rotation

You can reverse the direction that the focusing ring of RF lens is rotated to adjust settings.

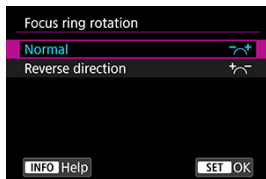

- [↔] Normal
- [↔] Reverse direction

Focusing ring sensitivity of RF lenses

You can set the sensitivity of the RF lens focusing ring.

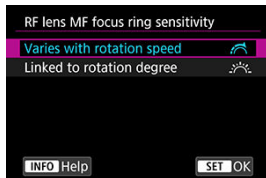

- [⚙️] **Varies with rotation speed**
Focusing ring sensitivity varies depending on rotation speed.
- [☀️] **Linked to rotation degree**
The focal position is adjusted based on the amount of rotation, regardless of the rotation speed.

Use as a focusing or control ring

Menu-based switching of lens focus/control ring functionality.

⚠ Caution

- Available when using lenses that have a combination focusing ring/control ring but have no switch to switch between these features.

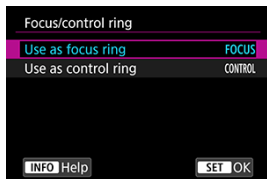

- **Use as focus ring**
The ring works as a focusing ring.
- **Use as control ring**
The ring works as a control ring.

📄 Note

- Switching is also possible from the Quick Control screen, when customized with [📷: Customize Quick Controls] (🔗).

Movie Servo AF speed

You can set the AF speed and operating conditions for Movie Servo AF. The function is enabled when using a lens supporting slow focus transition during movie recording*.

- **When active**



You can set **[Always on]** to have the AF speed take effect at all times for movie recording (before and during movie recording) or set **[During shooting]** to have the AF speed take effect only during movie recording.

- **AF speed**

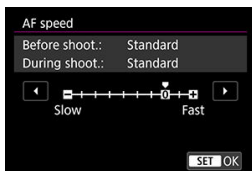

You can adjust the AF speed (focus transition speed) from the standard speed (0) to slow (one of seven levels) or fast (one of two levels) to obtain the desired effect for the movie creation.

*** Lenses supporting slow focus transition during movie recording**

USM and STM lenses released in and after 2009 are compatible. For details, refer to the Canon website ([🌐](#)).

⚠ Caution

- With certain lenses, even if you adjust the AF speed, the speed may not change.

Note

- Operation when inactive is equivalent to when [AF speed] is set to [Standard (0)].
- An asterisk "*" to the right of [AF: Movie Servo AF speed] indicates that the default setting has been modified.

Movie Servo AF tracking sensitivity

You can adjust the tracking sensitivity (to one of seven levels), which affects responsiveness if the subject strays from the AF point during Movie Servo AF, as when interfering objects move across AF points or when you pan.

This function is available when [AF: Movie Servo AF] is set to [Enable].

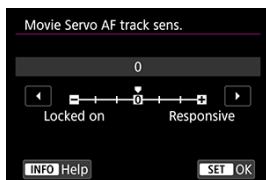

● Locked on: -3/-2/-1

With this setting, the camera is less likely to track a different subject if the subject strays from the AF point. The closer the setting is to the minus (-) symbol, the less the camera is inclined to track a different subject. It is effective when you want to prevent the AF points from rapidly tracking something that is not the intended subject during panning or when an obstacle cuts across the AF points.

● Responsive: +1/+2/+3

This makes the camera more responsive when tracking a subject that covers the AF point. The closer the setting is to the plus (+) symbol, the more responsive the camera is. It is effective when you want to keep tracking a moving subject as its distance from the camera changes or to rapidly focus on another subject.

Note

- Operation when inactive is equivalent to when set to [0].

Selecting the Drive Mode

Single and continuous drive modes are provided. You can select the drive mode suiting the scene or subject.

1. Press the <M-Fn> button (ⓘ6).

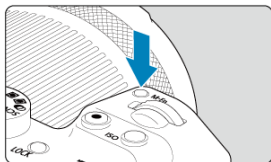

- With an image displayed on the screen, press the <M-Fn> button.

2. Select the drive mode item.











- Turn the <ⓘ6> dial to select the drive mode item.

3. Select the drive mode.



- Turn the <ⓘ6> dial to make a selection.

-  **Single shooting**
When you hold down the shutter button completely, only one shot will be taken.
-  **High-speed continuous shooting +**
When you hold down the shutter button completely, you can shoot continuously as described below while you keep holding it down, based on the  **Shutter mode** setting.
 - **[Mechanical]**: max. approx. 15 shots/sec.
 - **[Elec. 1st-curtain]**: max. approx. 15 shots/sec.
 - **[Electronic]**: max. approx. 30 shots/sec.
-  **High-speed continuous shooting**
When you hold down the shutter button completely, you can shoot continuously as described below while you keep holding it down, based on the  **Shutter mode** setting.
 - **[Mechanical]**: max. approx. 6.5 shots/sec.
 - **[Elec. 1st-curtain]**: max. approx. 8.0 shots/sec.
 - **[Electronic]**: max. approx. 15 shots/sec.
-  **Low-speed continuous shooting**
When you hold down the shutter button completely, you can shoot continuously at **max. approx. 3.0 shots/sec.** while you keep holding it down.
-  **Self-timer: 10 sec./remote control**
-  **Self-timer: 2 sec./remote control**
-  **Self-timer: Continuous**
For self-timer shooting, see [Using the Self-Timer](#). For remote control shooting, see [Remote Control Shooting](#).





Caution

-  enables approx. 15 shots/sec. continuous shooting speed when set to **[Elec. 1st-curtain]** or **[Mechanical]** under these conditions.
 - Room temperature (23°C/73°F)
 - Using any of the following power sources
 - Fully charged LP-E6NH (note that continuous shooting speed may become slower when using batteries with weak recharge performance)
 - Household power outlet accessories (sold separately)
 - USB power adapters (sold separately)
 - Shutter speed: 1/1000 sec. or faster
 - Flicker reduction: None

-  enables approx. 30 shots/sec. continuous shooting speed when set to **[Electronic]** under these conditions.

- Shutter speed: 1/30 sec. or faster

Note that the continuous shooting speed may be less than 30 shots/sec. if any of the following occurs during continuous shooting.

- Switching to **<P>** or **<Tv>** shooting mode, or applying settings that cause the aperture value to change in **<Fv>** mode
 - Zooming is performed
 - Manual focusing is performed
 - Servo AF changes the position in focus
- Continuous shooting speed with Servo AF may be slower depending on subject conditions or the lens used.
 - Visit the Canon website for details on lenses supporting the maximum continuous shooting speed .
 - Continuous shooting speed may be lower when shooting under flickering light with : **Anti-flicker shoot.** set to **[Enable]** . Also, the continuous shooting interval may become irregular and the release time lag may become longer.
 - When internal memory becomes full during continuous shooting, the continuous shooting speed may drop off because shooting will be temporarily disabled .

Using the Self-Timer

Use the self-timer when you want to be in the picture such as a commemorative photograph.

1. Press the <M-Fn> button (Ⓞ6).

- With an image displayed on the screen, press the <M-Fn> button.

2. Select the drive mode item.



- Turn the <Ⓞ> dial to select the drive mode item.

3. Select the self-timer.



- Turn the <Ⓞ> dial to select the self-timer.

Ⓞ: Shoot in 10 sec.

Ⓞ: Shoot in 2 sec.

Ⓞ: Shoot continuously in 10 sec. for the specified number of shots*

* Set the number of shots taken continuously (2–10), either in [📷: Drive mode] or on the Quick Control screen.

4. Take the picture.

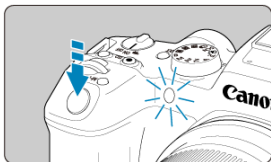

- Focus on the subject, then press the shutter button completely.
- To check operation, look at the self-timer lamp, listen for beeps, or watch the countdown in seconds on the screen.
- Self-timer lamp blinking accelerates and the camera beeps quickly approx. 2 sec. before the picture is taken.

⚠ Caution

- With [i/c], some conditions in continuous shooting may lengthen the shooting interval, such as image quality and use of flash.

📌 Note

- [i/c] is used to start shooting without touching the camera (to avoid camera shake) when it is mounted on a tripod for shots such as still lifes or long exposures, for example.
- After taking self-timer shots, playing back the image (📷) to check focus and exposure is recommended.
- When using the self-timer to shoot yourself, use focus lock (🔒) on an object at the same distance as where you will stand.
- To cancel the self-timer after it starts, either tap the screen or press the < (📷) > button.
- Auto power off time may be extended when the camera is set for remote control shooting.

Remote Control Shooting

- ☑ [Remote Controller RC-6](#)
- ☑ [Wireless Remote Control BR-E1](#)
- ☑ [Remote Switch RS-60E3](#)

For remote control shooting, you can use Remote Controller RC-6, Wireless Remote Control BR-E1, or Remote Switch RS-60E3 (infrared, Bluetooth, and wired connections, respectively; sold separately).

Remote Controller RC-6

You can shoot remotely up to approx. 5 meters/16.4 feet away from the front of the camera. You can either shoot immediately or with a 2-sec. delay.

1. Press the **<M-Fn>** button (ⓘ6).

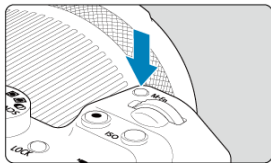

- With an image displayed on the screen, press the **<M-Fn>** button.

2. Select the self-timer/remote control.



- Turn the **<ⓘ>** dial to select the drive mode item, then turn the **<ⓘ2>** dial to select [ⓘ6] or [ⓘ2].

3. Press the release (transmit) button on the remote controller.

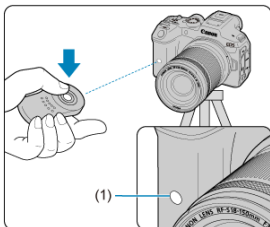

- Point the remote controller toward the camera's remote control sensor (1), then press the release (transmit) button.
- Autofocusing is performed when the focus mode switch is set to <AF>.
- The self-timer lamp lights up, and the camera shoots.

⚠ Caution

- Infrared remote controllers such as the RC-6 cannot be used for remote control shooting when the camera is paired via Bluetooth with a smartphone or wireless remote control.
- Fluorescent or LED lighting may trigger accidental shutter release. Try to keep the camera away from these light sources.
- Operating a TV remote control or similar device aimed at the camera may trigger accidental shutter release.
- Firing flash units of other cameras near the camera may trigger accidental shutter release. Do not expose the remote control sensor to flash fired by other cameras.

Wireless Remote Control BR-E1

You can shoot remotely up to approx. 5 meters/16.4 feet from the camera. After pairing the camera and BR-E1 (🔗), set the drive mode to [i📷] or [i📷2] for still photo shooting (📷). For movie recording, set [📷: Remote control] to [Enable]. For operating instructions, refer to the BR-E1 instruction manual.

Note

RC-6 and BR-E1

- Auto power off time may be extended when the camera is set for remote control shooting.
- RC-6 and BR-E1 can also be used for movie recording (🔗).

Remote Switch RS-60E3

Once connected to the camera, the switch enables you to shoot remotely over a wired connection.

For operating instructions, refer to the RS-60E3 instruction manual.

1. **Open the terminal cover.**
2. **Connect the plug to the remote control terminal.**

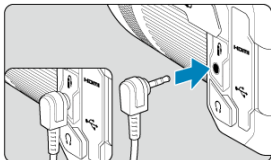

Customizing Operation

- [Switching AF Areas with the Quick Control Dial](#)
- [Choosing One Subject from Several People with the Multi-Controller](#)
- [Adjusting the Zone AF Frame Size](#)

This section describes ways to customize AF operation. You can also use a combination of customized settings.

Switching AF Areas with the Quick Control Dial

You can switch AF areas with the Quick control dial as you look through the viewfinder.

1. In []: Customize dials], select [].



2. Select [Select AF area].



- You can now switch AF areas with the < > dial.



Note

- Before switching among Flexible Zone AF 1–3, it is convenient to change the Zone AF frame to your preferred size (Ⓔ).

Choosing One Subject from Several People with the Multi-Controller

You can choose one subject from several people to lock the tracking frame on that person.

Note

- Before this customization, some other settings must be set as follows.
 - [AF area]: [Whole area AF]
 - [Subject tracking]: [On]
 - [Subject to detect]: [People]
 - [Eye detection]: [Enable]

1. In [Customize buttons], set [Direct AF point selection] to [Direct AF point selection].

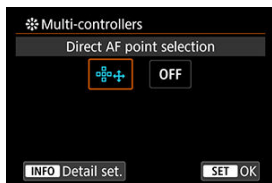

2. Select [INFO Detail set.], and in [Direct sel. on * press], select [Start/stop tracking].

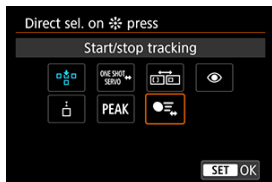

3. Press the shutter button halfway, then release it.



- A tracking frame (◀ ▶) is displayed if multiple subjects are detected.

4. Use the Multi-controller to set your preferred subject.



- Either press the Multi-controller straight in or press it left or right. The tracking frame changes to [◀ ▶] and locks on to that subject for tracking.
- To release locked tracking, press the Multi-controller.

Adjusting the Zone AF Frame Size

You can resize the Zone AF frame displayed for Flexible Zone AF 1–3.

1. Press the **< [AF] >** button during shooting screen display.

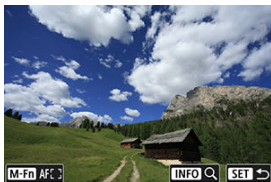

2. Press the **< M-Fn >** button.





3. Press the **< M-Fn >** button and select Flexible Zone AF 1, 2, or 3.

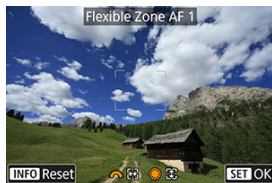

4. Press the  button.



5. Adjust the Zone AF frame size.

- Use the  or  dial to adjust the Zone AF frame, then press the  button.
- To restore the default setting, press the **<INFO>** button.

Playback

This chapter covers topics related to playback—playing back captured still photos and movies—and introduces menu settings on the playback [▶] tab.

Caution

- Normal display or selection on this camera may not be possible for images captured on other cameras, or images from this camera that have been edited or renamed on a computer.

- [Tab Menus: Playback](#)
- [Image Playback](#)
- [Magnified Image Display](#)
- [Index Display \(Multiple-Image Display\)](#)
- [Movie Playback](#)
- [Editing a Movie's First and Last Scenes](#)
- [Frame Extraction from 4K Movies or 4K Time-Lapse Movies](#)
- [Playback on a TV Set](#)
- [Protecting Images](#)
- [Erasing Images](#)
- [Rotating Still Photos](#)
- [Changing Movie Orientation Information](#)
- [Rating Images](#)
- [Copying Images](#)
- [Print Ordering \(DPOF\)](#)
- [Photobook Set-up](#)
- [RAW Image Processing](#)
- [Creative Assist](#)
- [Quick Control RAW Processing](#)
- [Cloud RAW Image Processing](#)
- [Playback Creative Filters](#)
- [Resizing JPEG/HEIF Images](#)
- [Cropping JPEG/HEIF Images](#)
- [Converting HEIF to JPEG](#)
- [Slide Show](#)
- [Setting Image Search Conditions](#)
- [Resuming from Previous Playback](#)
- [Browsing Images with the Main Dial](#)

- [Customizing Playback Information Display](#)
- [Displaying the Highlight Alert](#)
- [AF Point Display](#)
- [Playback Grid](#)
- [Movie Play Count](#)
- [Still Photo Extraction from RAW Burst Images](#)
- [HDMI HDR Output](#)

Tab Menus: Playback

● Playback 1

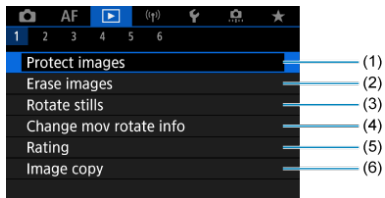

- (1) [Protect images](#)
- (2) [Erase images](#)
- (3) [Rotate stills](#)
- (4) [Change mov rotate info](#)
- (5) [Rating](#)
- (6) [Image copy](#)

● Playback 2

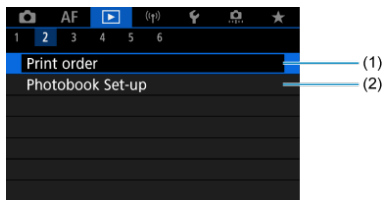

- (1) [Print order](#)
- (2) [Photobook Set-up](#)

● Playback 3

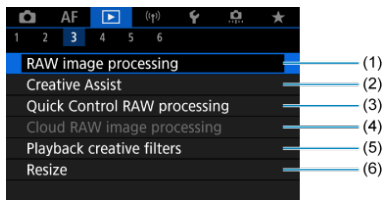

- (1) [RAW image processing](#)
- (2) [Creative Assist](#)
- (3) [Quick Control RAW processing](#)
- (4) [Cloud RAW image processing](#)
- (5) [Playback creative filters](#)
- (6) [Resize](#)

● Playback 4

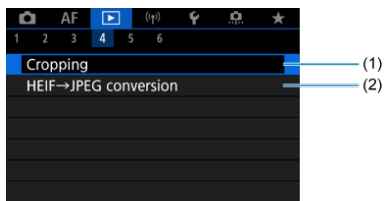

- (1) [Cropping](#)
- (2) [HEIF→JPEG conversion](#)

● Playback 5

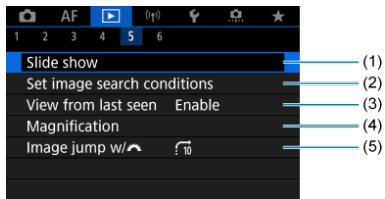

- (1) [Slide show](#)
- (2) [Set image search conditions](#)
- (3) [View from last seen](#)
- (4) [Magnification](#)
- (5) [Image jump w/ !\[\]\(9063468a59e93f469b71000ac5796bc3_img.jpg\)](#)

● Playback 6

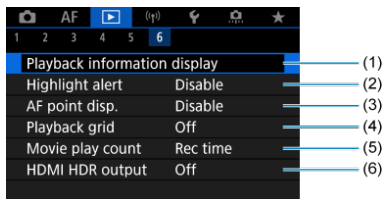

- (1) [Playback information display](#)
- (2) [Highlight alert](#)
- (3) [AF point disp.](#)
- (4) [Playback grid](#)
- (5) [Movie play count](#)
- (6) [HDMI HDR output](#)

In Basic Zone modes, the following screens are displayed for [▶3], [▶4], and [▶5].

● Playback 3

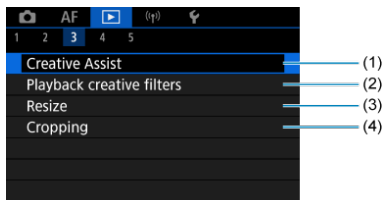

- (1) [Creative Assist](#)
- (2) [Playback creative filters](#)
- (3) [Resize](#)
- (4) [Cropping](#)

● Playback 4

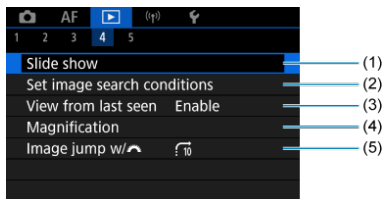

- (1) [Slide show](#)
- (2) [Set image search conditions](#)
- (3) [View from last seen](#)
- (4) [Magnification](#)
- (5) [Image jump w/ ☀️](#)

● Playback 5

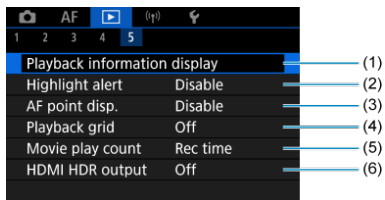

- (1) [Playback information display](#)
- (2) [Highlight alert](#)
- (3) [AF point disp.](#)
- (4) [Playback grid](#)
- (5) [Movie play count](#)
- (6) [HDMI HDR output](#)

Image Playback

[Single-Image Display](#)

[Shooting Information Display](#)

[Touch Playback](#)

Single-Image Display

1. Switch to playback.



- Press the <  > button.
- The last image captured or played back is displayed.

2. Browse images.

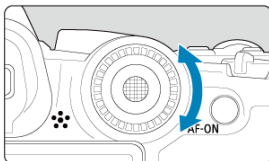



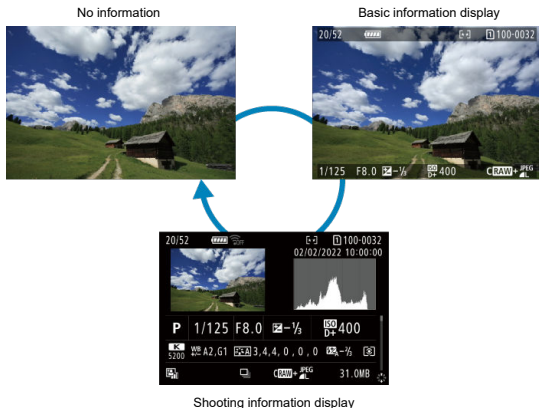



- To play back images starting with your most recent shot, turn the <  > dial counterclockwise. To play back images starting with the first captured image, turn the dial clockwise.
- Each time you press the < **INFO** > button, the display will change.



3. Exit image playback.

- Press the <  > button to exit image playback and return to shooting standby.

Note

- Lines indicating the image area are shown on RAW images captured with [: **Still img aspect ratio**] set to [1:1], [4:3], or [16:9] ().
- If the search conditions are set with [: **Set image search conditions**] (), only the filtered images will be displayed.
- When played back, images captured with [: **Add cropping information**] set to an option other than [**Disable**] () are displayed with lines indicating the image area.

Shooting Information Display

With the shooting information screen displayed (📷), you can press < ⌘ > up or down to view other information. You can also customize the information displayed, in [▶]: **Playback information display** (📷).

Touch Playback

The camera features a touch-screen panel that you can touch to control playback. Supported touch operations are like those used with smartphones and similar devices. First, press the <  > button to prepare for touch playback.

Browse images



Jump display



Index display



Magnified view



Note

- You can also magnify display by double-tapping with one finger.

Magnified Image Display

- ☑ [Setting the Initial Magnification Ratio](#)
- ☑ [Setting the Initial Magnification Position](#)
- ☑ [Magnification for Subsequent Images](#)

You can magnify display of your captured images.

1. Magnify the image.



- Press the < Q > button.



- The magnified view will appear. The position of the magnified area (1) is displayed in the lower right of the screen, along with [🔍 Q].
- To magnify images, turn the < 🔄 > dial clockwise.
- To reduce magnification, turn the < 🔄 > dial counterclockwise. For index display (☑), keep turning the dial.

2. Scroll the image.

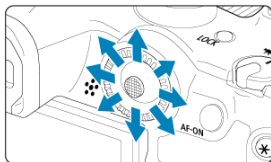

- Use < * > to scroll around the magnified image.
- Press the < Q > or < MENU > button to exit magnified view.

Note

- To switch to other images while maintaining magnified view, turn the <  > dial.
- Magnification is not available for movies.

Setting the Initial Magnification Ratio

You can set the initial magnification ratio.

1. Select [**▶**: Magnification].

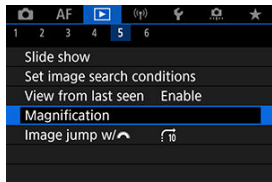

2. Select [Magnificatn (apx)].

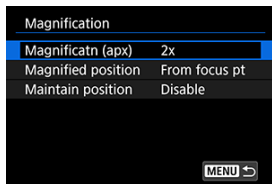

3. Select an option.

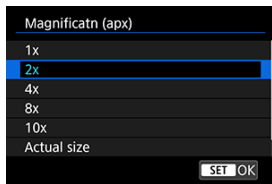

- **1x, 2x, 4x, 8x, 10x**

Magnified view starts at the selected magnification ratio.

- **Actual size**

The recorded image's pixels will be displayed at approx. 100%.

- **Same as last**

Magnified view resumes from the same ratio as the last time you exited magnified view by pressing < ▶ > or < Q >.

Setting the Initial Magnification Position

You can set the initial magnification position.

1. Select [**▶**]: Magnification].

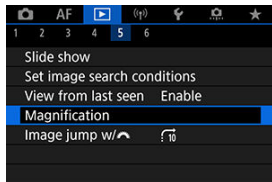

2. Select [Magnified position].

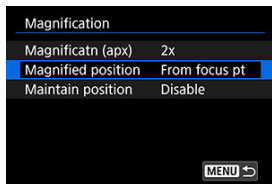

3. Select an option.

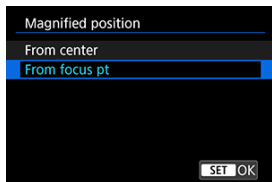

- **From center**

Magnified view starts from the center of the screen.

- **From focus pt**

Magnified view starts from the AF point in focus. If the photo is taken with manual focus, the magnified view starts from the center of the screen.

Magnification for Subsequent Images

You can specify whether to maintain the same position for magnified view or to use the position set in **[Magnified position]** when displaying subsequent images.

1. Select **[: Magnification]**.

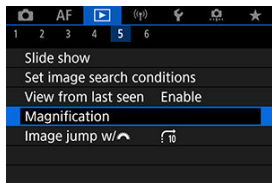

2. Select **[Maintain position]**.

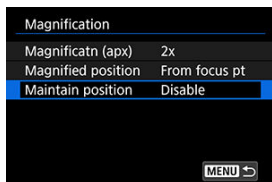

3. Select an option.

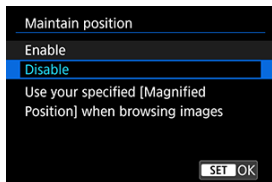

- **Enable**

The current magnified position is maintained when displaying subsequent images in magnified view.

- **Disable**

The position set in [**Magnified position**] is used when displaying subsequent images in magnified view.

Index Display (Multiple-Image Display)

1. Press the <Q> button.



- During image playback, press the <Q> button.
- [☀️Q] will be displayed in the lower right of the screen.

2. Switch to the index display.

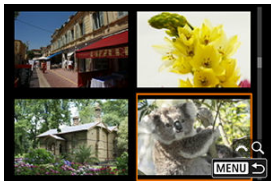
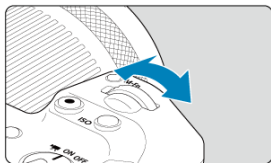

- Turn the <☀️> dial counterclockwise.
- The 4-image index display will appear. The selected image is highlighted with an orange frame.
- Turning the <☀️> dial further counterclockwise will switch the display from 9 to 36 to 100 images. Turning the dial clockwise cycles through 100, 36, 9, 4, and single-image display.

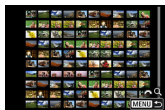

3. Browse images.



- Use < * > or the < ⌚ > dial to move the orange frame for image selection.
- Press the < Ⓜ > button in the index display to show the selected image in single-image display.

Movie Playback

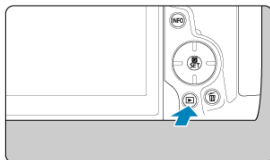

1. Switch to playback.





- Press the <  > button.

2. Select a movie.

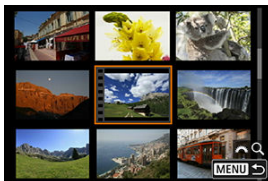

- Turn the <  > dial to select a movie to play.
- In single-image display, the [**SET** ] icon displayed in the upper left of the screen indicates a movie.





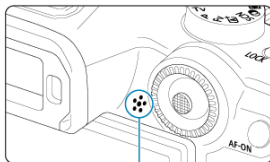

- In index display, perforations at the left edge of a thumbnail indicate a movie. Movies cannot be played from index display, so press the <  > button to switch to single-image display.

3. In single-image display, press the <  > button.

4. Select .



(1)

- The movie will start playing back. Sound is played through the speaker (1).
- You can pause playback and access the movie playback panel by pressing the <  > button (). Press it again to resume the playback.
- Press the <  > <  > keys to adjust the volume (even during playback).

Movie playback panel



Item	Playback Operations
Playback	Pressing the < > button toggles between playing movies and stopping playback.
Skip backward	Skips backward approx. 1 sec. each time you press < >. Holding < > down will rewind the movie.
Previous frame	Displays the previous frame each time you turn the < > dial left.
Next frame	Plays the movie frame-by-frame each time you turn the < > dial right.
Skip forward	Skips forward approx. 1 sec. each time you press < >. Holding < > down will fast forward the movie.
	Playback position
hh:mm:ss	Playback time (hours:minutes:seconds, when [Movie play count] is set to [Rec time])
hh:mm:ss.ff (DF) hh:mm:ss:ff (NDF)	Time code (hours:minutes:seconds:frames, when [Movie play count] is set to [Time code])
Volume	Press the < > < > keys to adjust the speaker volume ().
	Press the < > button to go to the next screen ().
	Press the < MENU > button to return to single-image display.



Controls not on the previous screen are as follows.

Item	Playback Operations
Edit	Displays the editing screen ().
Slow motion	Adjust the slow motion speed by turning the dial. The slow motion speed is indicated in the upper right of the screen.
Frame Grab	Available when you play 4K movies. Enables you to extract the current frame and save it as a JPEG or HEIF still image ().
MENU	Press the < MENU > button to return to the previous screen.

Caution

- Adjust the volume using television controls when the camera is connected to a television for movie playback () , because volume cannot be adjusted by pressing the **< ▲ >** **< ▼ >** keys.
- Movie playback may stop if the card's read speed is too slow or movie files have corrupted frames.

Editing a Movie's First and Last Scenes

You can edit out the first and last scenes of a movie in approx. 1-sec. increments.

1. Pause movie playback.

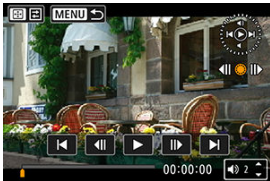

- The movie playback panel will appear.

2. Press the < [] > button, then select []<.

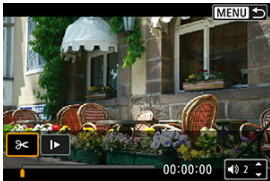

3. Specify the part to be edited out.

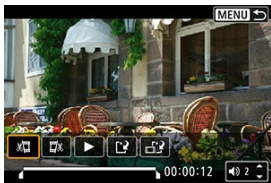

- Select either [Cut beginning] or [Cut end].

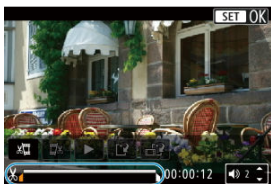

- Press < * > left or right to go back or forward one frame. Keep pressing the Multi-controller to fast rewind or fast forward frames. Each turn of the < dial > dial goes back or forward one frame.
- After deciding which part to edit out, press the < SET > button. The portion indicated by a line at the bottom of the screen will remain.



4. Check the edited movie.





- Select [Play] to play back the edited movie.
- To change the edited part, go back to step 3.
- To cancel the editing, press the < MENU > button.

5. Save.



- Select **[]** (1).
- The save screen will appear.
- To save it as a new file, select **[New file]**, or to save it and overwrite the original movie file, select **[Overwrite]**.
Select **[]** (2) to save a compressed version of the file. 4K movies are converted to Full HD movies before compression.
- On the confirmation screen, select **[OK]** to save the edited movie and return to the movie playback screen.

Caution







- Because editing is performed in approx. 1 sec. increments (at the position indicated by **[]** at the bottom of the screen), the actual position where movies are trimmed may differ from your specified position.
- Movies shot with another camera cannot be edited with this camera.
- You cannot edit a movie when the camera is connected to a computer.
- Compress and save is not available for the following movies.
 - Movies recorded with **[: HDR shooting (HDR PQ)]** set to **[Enable]**
 - Movies recorded with **[: Canon Log settings]** set to **[On (C.LOG3)]**
 - Movies recorded in **[FHD 29.97P (IPB)]** (NTSC), **[FHD 25.00P (IPB)]** (PAL), or **[FHD 23.98P (IPB)]** (NTSC) sizes
- Movies may not be compressed when the remaining battery capacity is low. Use of a fully charged battery or a household power outlet accessory (sold separately) is recommended.
- For extensive movie editing, consider using an optional household power outlet accessory.

Frame Extraction from 4K Movies or 4K Time-Lapse Movies

From 4K or 4K time-lapse movies, you can select individual frames to save as JPEG or HEIF still images. This function is called "Frame Grab."

1. Select a 4K movie or 4K time-lapse movie.



- Turn the <  > dial to make a selection.
- On the shooting information screen () , 4K movies and 4K time-lapse movies are indicated by [], [], and [] icons.
- In index display, press the <  > button to switch to single-image display.

2. In single-image display, press the < > button.

3. Select [].



- The movie will start playing back.



4. Press the <  > button to pause the movie.

- The movie playback panel will appear.

5. Select a frame to grab.



- Use the movie playback panel to select the frame to grab as a still image.
- For movie playback panel instructions, see [Movie playback panel](#).

6. Press the <  > button, then select [].



7. Save.



- Select **[OK]** to save the current frame as a JPEG still image. HEIF images are saved if you grab frames from movies recorded with **[📷: HDR shooting (HDR PQ)]** set to **[Enable]**.
- Check the destination folder and image file number.

8. Select the image to display.

- Select **[View original movie]** or **[View extracted still image]**.

! Caution

- Frame grabbing is not possible from the following 4K movies.
 - Movies recorded with **[📷: Canon Log settings]** set to **[On (C.LOG3)]**
 - Movies recorded with other cameras
- Frame grabbing is not possible while the camera is connected to a computer.

Playback on a TV Set

By connecting the camera to a television with a commercially available HDMI cable, you can play back the captured still photos and movies on the television.

If the image does not appear on the TV screen, confirm that [**Video system**] is correctly set to [**For NTSC**] or [**For PAL**] (depending on the video system of your television).

1. Connect the HDMI cable to the camera.

- Insert the HDMI cable in the camera's < **HDMI OUT** > terminal.

2. Connect the HDMI cable to the television.

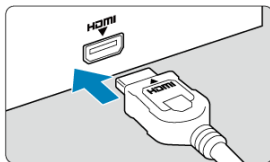

- Connect the HDMI cable to the television's HDMI IN port.

3. Turn on the television and switch the television's video input to select the connected port.

4. Set the camera's power switch to < ON >.

5. Press the < ▶ > button.

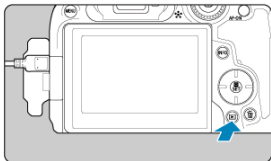

- Images are now displayed on the television, with nothing displayed on the camera screen.
- The images will automatically be displayed at the optimum resolution matching the connected television.

Caution

- Adjust movie sound volume with the television. The sound volume cannot be adjusted with the camera.
- Before connecting or disconnecting the cable between the camera and television, turn off the camera and television.
- Depending on the television, part of the image displayed may be cut off.
- Do not connect any other device's output to the camera's < **HDMI OUT** > terminal. Doing so may cause a malfunction.
- Certain televisions may not display the images due to incompatibility.
- It may take some time before images are displayed. To avoid delay, set [🔊: **HDMI resolution**] to [1080p] (🔒).
- Touch-screen operations are not supported while the camera is connected to a television.

Protecting Images

- ✔ [Protecting Individual Images](#)
- ✔ [Specifying the Range of Images to Protect](#)
- ✔ [Protecting All Images in a Folder or on a Card](#)

You can protect important images from being accidentally erased.

! Caution

- If you format the card (🗑️), the protected images will also be erased.

📄 Note

- Once an image is protected, it cannot be erased by the camera's erase function. To erase a protected image, you must first cancel the protection.
- If you erase all the images (🗑️), only the protected images will remain. This is convenient when you want to erase all unneeded images at once.

Protecting Individual Images

1. Select [🔒: Protect images].

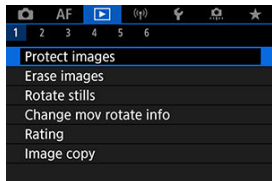

2. Select [Select images].

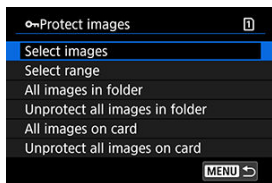





3. Select the image to protect.

- Turn the <  > dial to select an image to protect.

4. Protect the image.



- Press the <  > button to protect the selected image, after which it will be labeled with a  icon (1) at the top of the screen.
- To cancel protection and clear the  icon, press the <  > button again.
- To protect another image, repeat steps 3 and 4.

Note

- During playback, you can press the <  > button and protect images from the Quick Control screen.

Specifying the Range of Images to Protect

While looking at the images in the index display, you can specify the first and last images for a range to protect all the specified images at once.

1. Select [Select range].

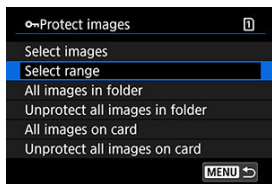

- Select [Select range] in [▶]: Protect images].

2. Specify the range of images.



- Select the first image (start point).
- Next, select the last image (end point). The images in the specified range will be protected and the [▶] icon will appear.
- To select another image to protect, repeat step 2.

Protecting All Images in a Folder or on a Card

You can protect all the images in a folder or on a card at once.

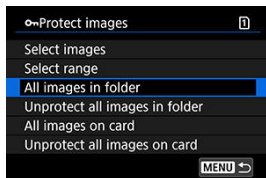

- When you select **[All images in folder]** or **[All images on card]** in **[]: Protect images**, all the images in the folder or on the card will be protected.
- To cancel protection, select **[Unprotect all images in folder]** or **[Unprotect all images on card]**.
- If the search conditions are set with **[]: Set image search conditions** (🔍), the display will change to **[All found images]** and **[Unprotect all found]**.

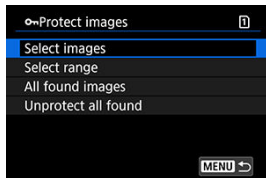

- If you select **[All found images]**, all the images filtered by the search conditions will be protected.
- If you select **[Unprotect all found]**, the protection of all the filtered images will be canceled.

Note

- Protecting or unprotecting images by selecting **[All images on card]** or **[Unprotect all images on card]** applies to the card selected in **[📁: Record func+card/folder sel.]** (in either **[📷 Record/play]/[📷 Record/play]** or **[📷 Play]/[📷 Play]**).

Erasing Images

- [Erasing Images Individually](#)
- [Selecting \(\[✓\]\) Multiple Images to Erase Together](#)
- [Specifying the Range of Images to Erase](#)
- [Erasing All Images in a Folder or on a Card](#)

You can either select and erase unnecessary images individually or erase them in one batch. Protected images (🔒) will not be erased.

⚠ Caution

- Once an image is erased, it cannot be recovered. Make sure you no longer need the image before erasing it. To prevent important images from being erased accidentally, protect them.

Erasing Images Individually

1. Press the <▶> button.
2. Select the image to be erased.
 - Turn the <⦿> dial to select the image to erase.
3. Press the <🗑> button.



4. Erase the images.

JPEG/HEIF/RAW images or movies

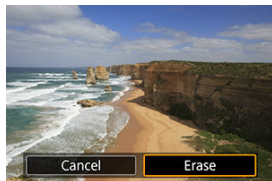

- Select **[Erase]**.

RAW+JPEG/RAW+HEIF images



- Select an option.
- Series of images captured in [RAW], [RAW+HEIF], or [RAW+JPEG] drive mode are erased when you select **[Erase scene including image]** during playback.

Selecting ([✓]) Multiple Images to Erase Together

By adding checkmarks to the images to be erased, you can erase all those images at once.

1. Select [▶]: Erase images].

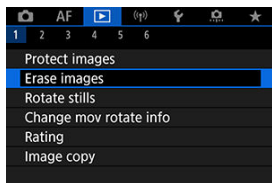

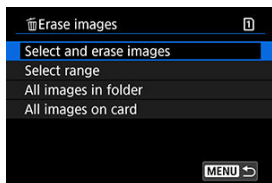

2. Select [Select and erase images].



3. Select an image.



- Turn the <  > dial to select an image to erase, then press the <  > button.
- To select another image to be erased, repeat step 3.
- Press the < MENU > button.

4. Erase the images.

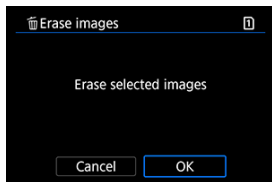

- Select **[OK]**.

Specifying the Range of Images to Erase

While looking at the images in the index display, you can specify the first and last images for a range to erase all the specified images at once.

1. Select [Select range].

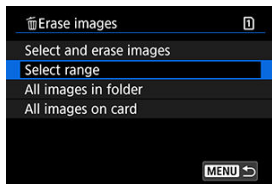

- Select [Select range] in [▶]: Erase images].

2. Specify the range of images.



- Select the first image (start point).
- Next, select the last image (end point). A checkmark [✓] will be appended to all the images within the range between first and last images.
- To select another image to be erased, repeat step 2.

3. Press the <MENU> button.

4. Erase the images.

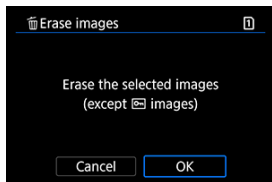

- Select **[OK]**.

Erasing All Images in a Folder or on a Card

You can erase all the images in a folder or on a card at once.

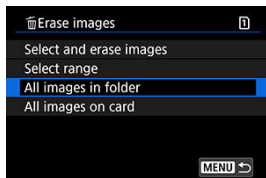

- When you select **[All images in folder]** or **[All images on card]** in **[▶]: Erase images**, all the images in the folder or on the card will be erased.
- If the search conditions are set with **[▶]: Set image search conditions** (🔍), the display will change to **[All found images]**.

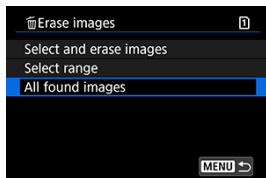

- If you select **[All found images]**, all the images filtered by the search conditions will be erased.

Note

- To erase all the images including protected images, format the card (🔗).
- Erasing images by selecting **[All images on card]** applies to the card selected in **[👉: Record func+card/folder sel.]** (in either **[📷 Record/play]/[📷 Record/play]** or **[📷 Play]/[📷 Play]**).

Rotating Still Photos

You can use this feature to rotate the displayed image to the desired orientation.

1. Select []: Rotate stills].

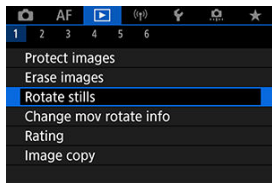

2. Select an image to rotate.

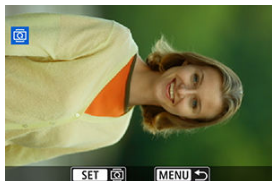

- Turn the < > dial to select the image.



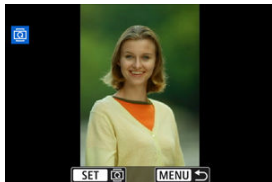

3. Rotate the image.



- Each time you press the < > button, the image is rotated clockwise as follows: 90° → 270° → 0°.
- To rotate another image, repeat steps 2 and 3.



Note

- If you set [**⚙**: **Auto rotate**] to [**On**] () before taking pictures, you need not rotate the image with this function.
- If the rotated image is not displayed in the rotated orientation during image playback, set [**⚙**: **Auto rotate**] to [**On**].
- Movies cannot be rotated.

Changing Movie Orientation Information

You can manually edit movie playback orientation information (which determines which side is up).

1. Select []: Change mov rotate info].

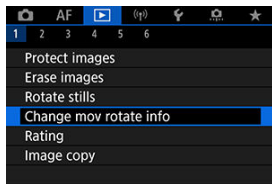

2. Select a movie.

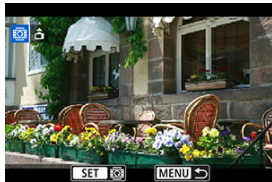

- Turn the <  > dial to select a movie with orientation information to change.

3. Change the orientation information.

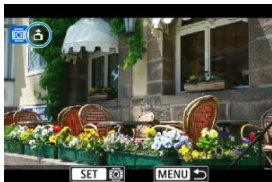

- As you watch the camera and ▲ icon in the upper left of the screen, press the < (📷) > button to specify which side is up. Each press of the < (📷) > button edits the movie rotation information as follows: [📷] → [📷] → [📷].

⚠ Caution

- Movies are played horizontally on the camera and via HDMI video output, regardless of the [📷: Add '🗨 rotate info] setting (🔒).
- Movie orientation information of movies recorded with other cameras cannot be edited with this camera.

Rating Images

- [Rating Individual Images](#)
- [Rating by Specifying the Range](#)
- [Rating All Images in a Folder or on a Card](#)

You can rate images on a scale of 1–5 ([*]/[* *]/[* * *]/[* * * *]/[* * * * *]). This function is called rating.
* Rating images can help you organize them.

Rating Individual Images

1. Select [▶]: Rating].

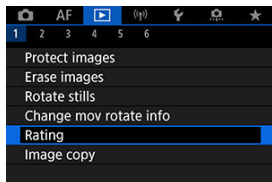

2. Select [Select images].

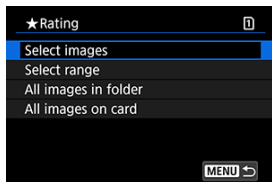





3. Select the image to be rated.

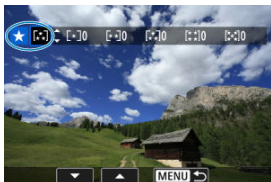

- Turn the <  > dial to select the image to be rated.

4. Rate the image.



- Press the <  > button so that the current rating is outlined in blue, as shown.
- Turn the <  > dial to select a rating mark, then press the <  > button.
- When you append a rating mark to the image, the number beside the set rating will increase by one.
- To rate another image, repeat steps 3 and 4.

Rating by Specifying the Range

While looking at the images in the index display, you can specify the first and last images for a range to rate all the specified images at once.

1. Select [Select range].

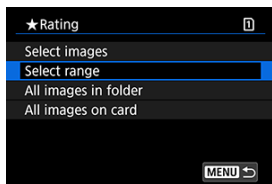

- Select [Select range] in [▶]: Rating.

2. Specify the range of images.



- Select the first image (start point).
- Next, select the last image (end point). A checkmark [✓] will be appended to all the images within the range between first and last images.
- To select other images, repeat step 2.

3. Press the <MENU> button.

4. Rate the image.



- Turn the <  > dial to select a rating mark, then select [OK]. All the images in the specified range will be rated (same rating) at once.

Rating All Images in a Folder or on a Card

You can rate all the images in a folder or on a card at once.

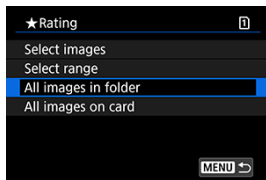

- Under **[▶]: Rating**, when you select **[All images in folder]** or **[All images on card]**, all the images in the folder or on the card will be rated.

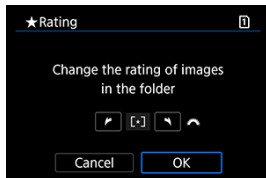

- Turn the **< [Sun] >** dial to select a rating, then select **[OK]**.
- When you are not rating images or canceling the rating, select **[OFF]**.
- If the search conditions are set with **[▶]: Set image search conditions** (🔍), the display will change to **[All found images]**.

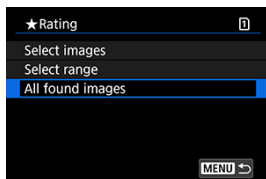

- If you select **[All found images]**, all the images filtered by the search conditions will be rated as specified.



Note

- Values next to ratings are displayed as [###] if more than 1,000 images have that rating.
- With [▶]: **Set image search conditions**] and [▶]: **Image jump w/🌅**], you can display only the images given a specific rating.

Copying Images

 [Copying Individual Images](#)

 [Copying a Range of Images](#)

 [Copying All Images in a Folder or on a Card](#)

You can copy the images on one card to the other card to save duplicates.
All images in a folder or on a card can also be copied at the same time.





Caution

- For extensive copying, consider using a household power outlet accessory (sold separately).
- If the target folder or card already has an image with the same file number, [**Skip image and continue**], [**Replace existing image**], and [**Cancel copy**] are displayed. Select a copying method, then press the <  > button.
 - [**Skip image and continue**]: Any images with the same file number are skipped and not copied.
 - [**Replace existing image**]: Any images with the same file number (including protected images) are overwritten.

Overwriting images that had print order information () will require you to set the print order information again.

- Print order and image transfer information is not included in copies of images.
- Shooting is not possible during the copying process. Select [**Cancel**] before shooting.

Note

- Images are copied from the card selected in [: **Record func+card/folder sel.**] (in either [ **Record/play**]/[ **Record/play**] or [ **Play**]/[ **Play**]).
- Copies of images have the same file name as the original image.
- With [**Sel. Image**], images in multiple folders cannot be copied at the same time. Select images to copy from one folder at a time.

Copying Individual Images

1. Select [: Image copy].

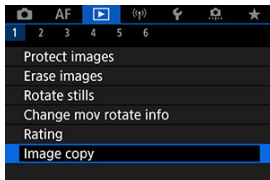

2. Select [Sel.Image].

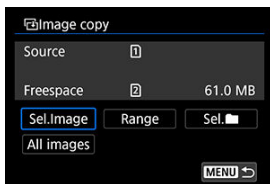

- Check the source and target card numbers and the free space on the target card.
- Select [Sel.Image], then press the < > button.

3. Select the folder.

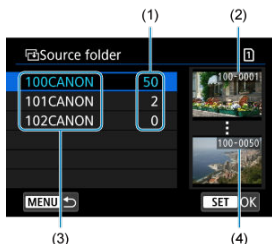



- (1) Number of images in folder
- (2) Lowest file number
- (3) Folder name
- (4) Highest file number

- Select the source folder, then press the <  > button.
- When selecting the folder, refer to the images displayed at right of the screen.

4. Select an image to copy.



- (1) Total images selected

- Turn the <  > dial to select an image to copy, then press the <  > button.
- To select another image to copy, repeat step 4.

5. Press the < MENU > button.

6. Select [OK].

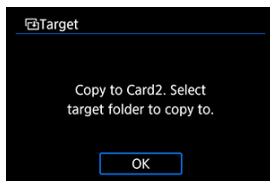

- Check the target card, then select [OK].

7. Select the target folder.

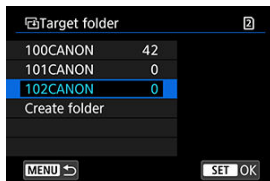

- Select the folder to copy the image to, then press the <  > button.
- To create a new folder, select [Create folder].

8. Select [OK].

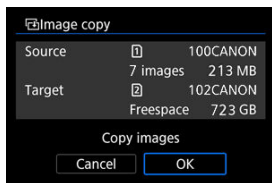

- Check the information about the source and target card, then select [OK].

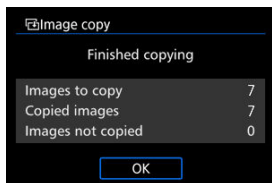

- Results are displayed after copying is finished. Select [OK] to return to the screen in step 2.

Copying a Range of Images

You can copy all specified images at once by selecting the first and last images in a range as you look at images in the index display.

1. Select [Range].

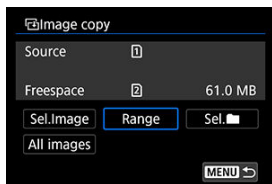

2. Select the folder.

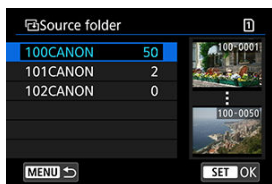

- Select the source folder, then press the <  > button.
- When selecting the folder, refer to the images displayed at right of the screen.

3. Specify the range of images.



- Select the first image (start point).
- Next, select the last image (end point). A checkmark [✓] will be appended to all the images within the range between first and last images.
- To select another image to copy, repeat step 3.

4. Press the <MENU> button.

- Images in the specified range are now copied.

Copying All Images in a Folder or on a Card

You can copy all the images in a folder or on a card at once.

Selecting [Sel. ] or [All images] in [: Image copy] copies all the images it contains.

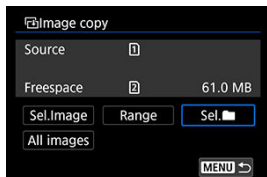

Print Ordering (DPOF)

 [Print Options](#)

 [Selecting Images for Printing](#)

DPOF (Digital Print Order Format) enables you to print images recorded on the card according to your printing instructions such as the image selection, quantity to print, etc. You can print multiple images in one batch or create a print order for a photofinisher.

You can set the print settings such as print type, date imprinting, file number imprinting, etc. The print settings will be applied to all the images specified for printing. (They cannot be set individually for each image.)

Print Options

1. Select []: Print order].

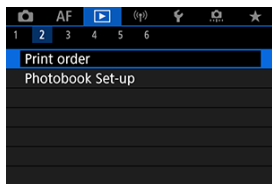



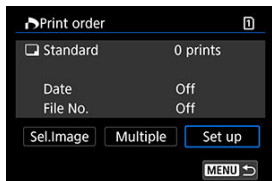

2. Select [Set up].



3. Set the options as desired.

- Set **[Print type]**, **[Date]**, and **[File No.]** options.

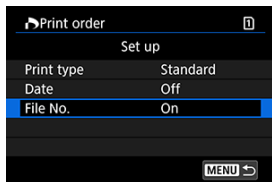

Print type		Standard	Prints one image on one sheet.
		Index	Multiple thumbnail images are printed on one sheet.
	 	Both	Prints both the standard and index prints.
Date	On	[On] imprints the recorded date of the captured image.	
	Off		
File No.	On	[On] imprints the file number.	
	Off		

4. Exit the setting.



- Press the < **MENU** > button.
- Next, select **[Sel.Image]** or **[Multiple]** to specify the images to be printed.

 **Caution**

- If you print an image with a large image size using the **[Index]** or **[Both]** setting () , the index print may not be printed with certain printers. In this case, resize the image () , then print the index print.
- Even if **[Date]** and **[File No.]** are set to **[On]**, the date or file number may not be imprinted, depending on the print type setting and printer.
- With **[Index]** prints, the **[Date]** and **[File No.]** cannot both be set to **[On]** at the same time.
- When printing with DPOF, use the card for which print order specifications are set. You cannot print in the specified print order if you extract just the images from the card for printing.
- Certain DPOF-compliant printers and photofinishers may not be able to print the images as you specified. When using a printer, refer to the printer's instruction manual. When requesting service from a photofinisher, ask in advance.
- Do not use this camera to configure print settings for images with DPOF settings set up on another camera. All the print orders may be overwritten inadvertently. Also, the print order may not be possible, depending on the image type.

Selecting Images for Printing

Selecting images

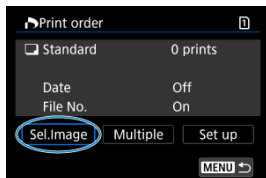

Select and specify the images individually.

Press the < MENU > button to save the print order to the card.

● Standard/Both



Press the < [Printer Icon] > button to set the print quantity for the current image to 1. By turning the < [Dial] > dial, you can set a print quantity of up to 99 copies.

● Index

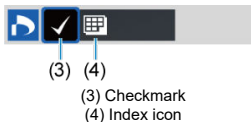

Images that you add a checkmark [✓] to by pressing the < [Printer Icon] > button are included in index printing.

Selecting multiple images

- **Select range**

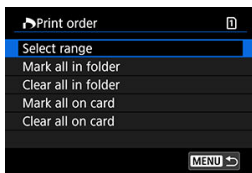

Select **[Select range]** in **[Multiple]**. Selecting the first and last images of the range marks all the images in the range with a checkmark [✓], and one copy of each image will be specified for printing.

- **All images in a folder**

Select **[Mark all in folder]** and select the folder. A print order for one copy of all the images in the folder will be specified.

If you select **[Clear all in folder]** and select the folder, the print order for all the images in the folder will be canceled.

- **All images on a card**

If you select **[Mark all on card]**, one copy of all the images on the card will be specified for printing.

If you select **[Clear all on card]**, the print order will be cleared for all the images on the card.

If the search conditions are set with **[▶]: Set image search conditions** (🔍) and you select **[Multiple]**, the display will change to **[Mark all found images]** and **[Clear all found images]**.

- **All found images**

If you select **[Mark all found images]**, one copy of all the images filtered by the search conditions will be specified for printing.

If you select **[Clear all found images]**, all the print order of the filtered images will be cleared.

⚠ Caution

- RAW/HEIF images and movies cannot be specified for printing. Note that RAW/HEIF images and movies will not be specified for printing even if you specify all images with **[Multiple]**.

Photobook Set-up

- [Specifying Individual Images](#)
- [Specifying the Image Range for a Photobook](#)
- [Specifying All Images in a Folder or on a Card](#)

You can specify up to 998 images to be printed in a photobook. When you use EOS Utility (EOS software) to import images to a computer, the specified images for a photobook will be copied to a dedicated folder. This function is useful for ordering photobooks online.

Specifying Individual Images

1. Select []: Photobook Set-up].

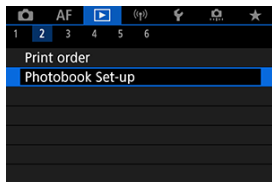

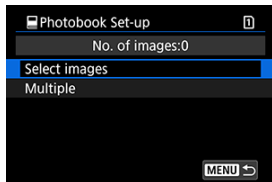

2. Select [Select images].



3. Select an image for the photobook.



- Use the <  > dial to select an image for the photobook, then press the <  > button.
- To select other images to be specified for a photobook, repeat step 3.

Specifying the Image Range for a Photobook

While looking at the images in the index display, you can specify the range (start point to end point) of images to be specified for a photobook at once.

1. Select [Multiple].

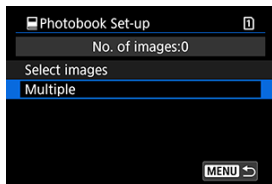

- Select [Multiple] in []: Photobook Set-up.

2. Select [Select range].

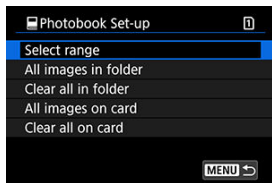

3. Specify the range of images.



- Select the first image (start point).
- Next, select the last image (end point).
A checkmark [✓] will be appended to all the images within the range between first and last images.

Specifying All Images in a Folder or on a Card

You can specify all the images in a folder or on a card at once for a photobook.

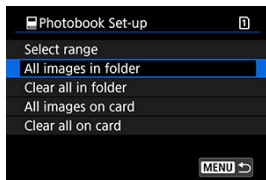

All images in the folder or on the card are specified for the photobook when you select **[All images in folder]** or **[All images on card]** in the **[Multiple]** option for **[▶]: Photobook Set-up**.

To cancel the selection, select **[Clear all in folder]** or **[Clear all on card]**.

If the search conditions are set with **[▶]: Set image search conditions** (🔍) and you select **[Multiple]**, the display will change to **[All found images]** and **[Clear all found images]**.

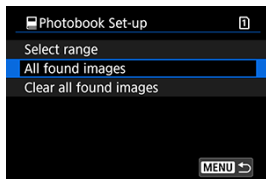

[All found images]: All images filtered by the search conditions are specified for the photobook.

[Clear all found images]: Clears photobook designation of all filtered images.

⚠ Caution

- RAW/HEIF images and movies cannot be specified for photobooks. Note that RAW/HEIF images and movies will not be specified for photobooks even if you specify all images with **[Multiple]**.
- Do not use this camera to configure photobook settings for images with photobook settings set up on another camera. All the photobook settings may be overwritten inadvertently.

RAW Image Processing

- [Magnified View](#)
- [Processing Images with Specified Aspect Ratios](#)
- [RAW Image Processing Options](#)

You can process **RAW** or **CRAW** images with the camera to create JPEG or HEIF images. The RAW images remain the same as when captured, so you can adjust the processing conditions to create as many JPEGs as needed.

You can also use Digital Photo Professional (EOS software) to process RAW images.

Caution

- Processing into HEIF is not available for **RAW** or **CRAW** images captured at an expanded ISO speed (H).

1. Select [: RAW image processing].

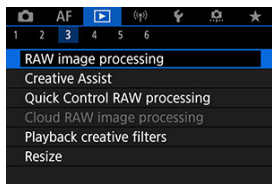

2. Select an option, then select images.

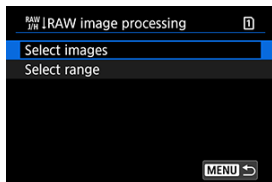

- You can select multiple images to process at once.

Select images



- Turn the $\langle \text{DIAL} \rangle$ dial to select an image to process, then press the $\langle \text{MENU} \rangle$ button.
- Press the $\langle \text{MENU} \rangle$ button.

Select range

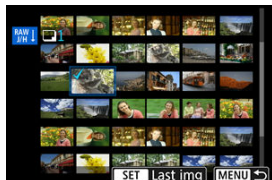

- Select the first image (start point).
- Next, select the last image (end point). A checkmark [✓] will be appended to all the images within the range between first and last images.
- To process other images, repeat this step.
- Press the $\langle \text{MENU} \rangle$ button.

3. Set the desired processing conditions.

Use shot settings

- Images are processed using image settings at the time of capture.
- Images captured with [CAMERA: HDR shooting **HDR PQ**] set to [Enable] are processed to create HEIFs, and images captured with this function set to [Disable] are processed to create JPEGs.

Set up processing → JPEG/Set up processing → HEIF



- Use <☼> to select an item.
- Turn the <☺️> or <☺️> dial to switch the setting.
- Press the <☺️> button to access the function setting screen.
- To reset the settings, press the <🗑️> button and select [OK] after a confirmation message is displayed.

Comparison screen

- You can switch between the [After change] and [Shot settings] screens by pressing the <INFO> button and turning the <☺️> dial.
- Items in orange on the [After change] screen have been modified since the time of capture.
- Press the <MENU> button to return to the processing conditions screen.

4. Save.

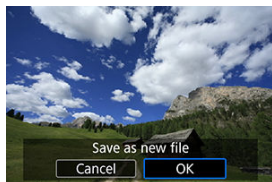

- When using [**Set up processing**→**JPEG**] or [**Set up processing**→**HEIF**], select [**S**] (Save).
- Read the message and select [**OK**].
- To process other images, select [**Yes**] and repeat steps 2–4.

5. Select the image to display.



- Select [**Original image**] or [**Processed img.**].
- Your selected image is displayed.



Magnified View

You can magnify images displayed for **[Set up processing→JPEG]** or **[Set up processing→HEIF]** by pressing the <Q> button. The magnification ratio varies depending on the **[Image quality]** setting. With <⌘>, you can scroll around the magnified image. To cancel the magnified view, press the <Q> button again.

Caution

- Results of processing with **[Digital Lens Optimizer]** set to **[High]** are only applied in magnified view. Results are not applied in normal display.

Processing Images with Specified Aspect Ratios

JPEG or HEIF images at the specified aspect ratio are created when you process RAW images captured with : **Still img aspect ratio**  set to [1:1], [4:3], or [16:9].

RAW Image Processing Options

- ±0: **Brightness adjustment**

You can adjust the image brightness up to ±1 stop in 1/3-stop increments.

- : **White balance** (🔗)

You can select the white balance. Selecting enables you to select **[Auto: Ambience priority]** or **[Auto: White priority]**. If you select , you can set the color temperature.

- : **Picture Style** (🔗)

You can select the Picture Style. You can adjust the sharpness, contrast, and other parameters.

* , , , and are not available when **[Set up processing→HEIF]** is set.

- ±0: **Clarity** (🔗)

You can adjust clarity in a range of -4 to +4.

* Not available when **[Set up processing→HEIF]** is set.

- : **Auto Lighting Optimizer** (🔗) + : **Adj face lighting**

You can set the Auto Lighting Optimizer. With automatic, optimal adjustment of lighting on faces, you can effectively correct images captured with oblique lighting or illuminated by flash.

* Adjustment of face lighting is not available when **[Set up processing→HEIF]** is set.

Caution

When adjustment of face lighting is set

- Suitable adjustment may not be possible in some shooting situations unless faces can be detected in detail and are not too dark.
- Noise may increase.
- Adjustment may be less effective at high ISO speeds.

- : **High ISO speed NR** (🔗)

You can set the noise reduction processing for high ISO speeds. If the effect is difficult to discern, magnify the image (🔗).

● : Image quality

You can set the image quality when creating a JPEG or HEIF image.



● : sRGB: Color space

You can select either sRGB or Adobe RGB. Since the camera screen is not compatible with Adobe RGB, the difference in the image will hardly be perceptible when either color space is set.

* **[HDR PQ]** is displayed when **[Set up processing→HEIF]** is set but is not an option for selection.

● : Lens aberr correction

• OFF: Peripheral illum corr

A phenomenon that makes the image corners look darker due to the lens characteristics can be corrected. If **[Enable]** is set, the corrected image will be displayed. If the effect is difficult to discern, magnify the image  and check the four corners. Less correction is applied than for maximum correction with Digital Photo Professional (EOS software, ). If the effects of correction are not apparent, use Digital Photo Professional to apply the peripheral illumination correction.

• OFF: Distortion correction

Image distortion due to lens characteristics can be corrected. If **[Enable]** is set, the corrected image will be displayed. The image periphery will be trimmed in the corrected image.

Since the image resolution may look slightly lower, adjust the sharpness with the Picture Style's sharpness parameter setting as necessary.

• OFF: Digital Lens Optimizer

Correct lens aberration, diffraction, and low-pass filter-induced loss of resolution by applying optical design values. To check the effect of setting this option to **[High]** or **[Standard]**, use magnified view . Without magnification, the effect when Digital Lens Optimizer is set to **[High]** is not applied. Selecting **[High]** or **[Standard]** corrects both chromatic aberration and diffraction, although these options are not displayed.

• OFF: Chromatic aberr corr

Chromatic aberrations (color fringing along the subject's outline) due to the lens characteristics can be corrected. If **[Enable]** is set, the corrected image will be displayed. If the effect is difficult to discern, magnify the image .

•  OFF: **Diffraction correction** ()

The diffraction by the lens aperture degrading the image sharpness can be corrected. If **[Enable]** is set, the corrected image will be displayed. If the effect is difficult to discern, magnify the image () .

 **Caution**

- Processing RAW images in the camera will not produce exactly the same results as processing RAW images with Digital Photo Professional (EOS software).
- If you perform **[Brightness adjustment]**, noise, banding, etc. may be intensified with the effects of adjustment.
- When **[Digital Lens Optimizer]** is set, noise may be intensified together with the effects of correction.
- When **[Digital Lens Optimizer]** is set, image edges may be emphasized, under some shooting conditions. Adjust sharpness of the Picture Style as needed.
- Processing with **[Digital Lens Optimizer]** set to **[High]** may take some time.

 **Note**

- Effects of lens aberration correction vary by lens and by shooting conditions. Also, the effect may be difficult to discern depending on the lens used, shooting conditions, etc.

Creative Assist

You can process RAW images by applying your preferred effects and saving as JPEGs.

1. Select []: Creative Assist].

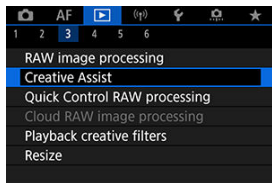

2. Select an image.



- Turn the < [] > dial to select an image to process, then press the < [] > button.

3. Select an effect.



- Use the <◀><▶> keys to select the effect.





- By selecting [**Preset**] and pressing the <Ⓢ> button, you can choose [**VIVID**], [**SOFT**], or other preset effects. [**AUTO1**], [**AUTO2**], and [**AUTO3**] are effects recommended by the camera based on image conditions.



- You can select effects such as [**Brightness**] or [**Contrast**] by pressing the <Ⓢ> button and then using the <◀><▶> keys.
- Press the <Ⓢ> button when adjustment is finished.



- To reset the settings, press the <  > button and select [OK] after a confirmation message is displayed.
- To confirm the effect, press the <  > button.

4. Select [OK] to save the image.

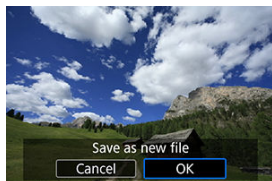

Quick Control RAW Processing

You can select the type of RAW image processing performed from the Quick Control screen.

1. Select [▶]: Quick Control RAW processing].

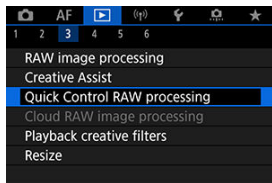

2. Select an option.

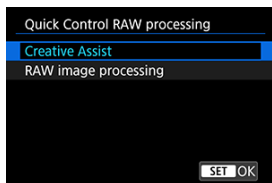

● Creative Assist



RAW processing that applies your preferred effect (🔗).

● RAW image processing



RAW processing according to conditions you specify (🔗).

Cloud RAW Image Processing

- [☑ Checking Processing Capacity](#)
- [☑ Adding Images to Process](#)
- [☑ Checking/Removing Selected Images](#)
- [☑ Uploading Images](#)

You can upload **RAW** or **CRAW** images to image.canon for processing into JPEG or HEIF images. The RAW images remain the same as when captured, so you can adjust the processing conditions to create as many JPEGs or HEIFs as needed.

Caution

- Complimentary enrollment at image.canon must be completed in advance. Note that cloud RAW image processing requires a paid subscription. For subscription details, visit the image.canon website.
- Images generated by this image processing are saved on image.canon servers. The processed images are not saved to the camera.

Note

- Before proceeding, connect the camera to image.canon ().

Checking Processing Capacity

You can check how many images you can process at image.canon.

1. Select [: Cloud RAW image processing].

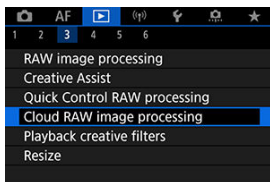

2. Select [Check proc. capacity (refresh)].

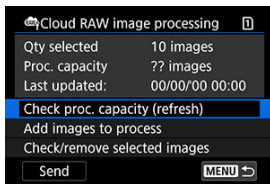

- The camera accesses image.canon.

3. Check the quantity in [Proc. capacity].

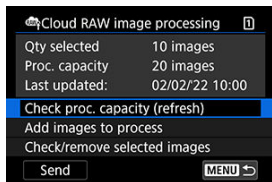

- Information in [**Proc. capacity**] is updated.

Caution

- [**Proc. capacity**] is [0] unless you have a paid subscription for cloud RAW image processing. You will receive subscription information at the email address on record at image.canon if you check the processing capacity without a subscription.

1. Select [Add images to process].

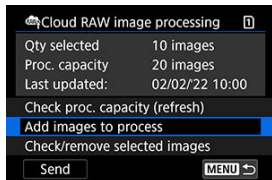

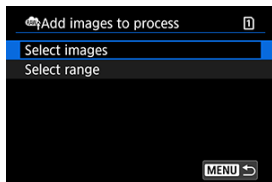

2. Select an option, then select images.



- You can select multiple images to process at once.

Select images



- Turn the <  > dial to select an image to process, then press the <  > button.
- Press the < MENU > button.

Select range



- Select the first image (start point).
- Next, select the last image (end point). A checkmark [✓] will be appended to all the images within the range between first and last images.
- To process other images, repeat this step.
- Press the < MENU > button.

3. Set the desired processing conditions.



Use shot settings



- Images are processed using image settings at the time of capture.
- Images captured with [📷: HDR shooting **HDR PQ**] set to [Enable] are processed to create HEIFs, and images captured with this function set to [Disable] are processed to create JPEGs.

Set up processing→JPEG/Set up processing→HEIF



- Use <☀️> to select an item.
- Turn the <⚙️> or <⌚> dial to switch the setting.
- Press the <📷> button to access the function setting screen.
- To return to the image settings at the time of shooting, press the <🗑️> button and select [OK] when "Revert to shot settings" is displayed.

Comparison screen

- You can switch between the **[After change]** and **[Shot settings]** screens by pressing the < INFO > button and turning the <  > or <  > dial.
- Items in orange on the **[After change]** screen have been modified since the time of capture.
- Press the < MENU > button to return to the processing conditions screen.

4. Select [Save].



- When using **[Set up processing→JPEG]** or **[Set up processing→HEIF]**, select [] (Save).
- Read the message and select **[OK]**.

5. Add to the upload list.

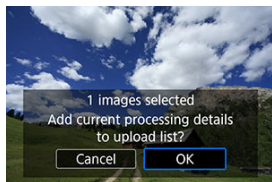

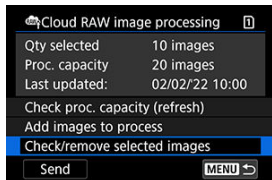

- Read the message and select **[OK]**.

1. Select [Check/remove selected images].



2. Browse your images.



- Turn the <  > dial to check images.
- To remove from the upload list, press the <  > button. [✓] is displayed.
- To check image processing conditions, press the <  > button.

3. Remove the current image from the upload list as needed.

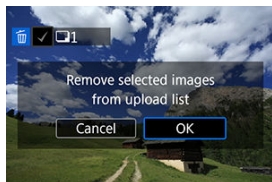

- Press the < MENU > button.
Select [OK] when a message is displayed about removing images from the upload list.

1. Select [Send].

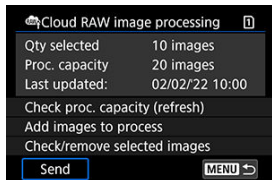

2. Read the message.



- Read the message, then tap [Send].

⚠ Caution

- The number of images and processing capacity may not be updated correctly if an [Err 138] transmission error occurs during uploading. Note that even if the number of images and processing capacity are not updated correctly, images may be processed on the server. To check the processing status, use the image.canon app.
- The camera continues to upload images even if [Stop] is selected on the [Send images] screen. To cancel uploading, select [OK] on the [Cancel transmission] screen while the access lamp is blinking.
- Depending on when you select [OK] on the [Cancel transmission] screen, uploading may continue, and the images may be processed on the server.

Playback Creative Filters

[Creative Filter Characteristics](#)

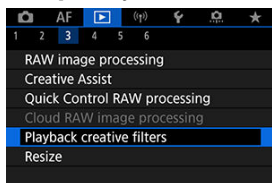

You can apply the following filter processing to an image and save it as a separate image: Grainy B/W, Soft focus, Fish-eye effect, Art bold effect, Water painting effect, Toy camera effect, and Miniature effect.

1. Select [: Playback creative filters].



2. Select an image.



- Turn the  dial to select an image, then press the  button.
- Images can be selected by touch from index display ().

3. Select a filter effect (🔍).



4. Adjust the filter effect.

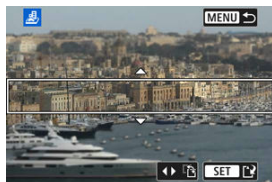

- Adjust the filter effect, then press the <ⓘ> button.
- For **[Miniature effect]**, turn the <🕒> dial to move the white frame enclosing the area to keep in sharper focus, then press the <ⓘ> button.

5. Save.

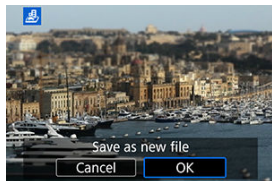

- Select **[OK]**.
- Check the destination folder and image file number, then select **[OK]**.
- To apply filter processing to other images, repeat steps 2–5.



Note

- RAW images cannot be selected. Note that for images captured in RAW+JPEG shooting, filter processing is applied to the JPEG image before saving the results.
- Images processed using the fish-eye effect filter will not have Dust Delete Data (DD) appended.

Creative Filter Characteristics

-  **Grainy B/W**

Makes the image grainy and black and white. By adjusting the contrast, you can change the black-and-white effect.

-  **Soft focus**

Gives the image a soft look. By adjusting the blur, you can change the degree of softness.

-  **Fish-eye effect**

Gives the effect of a fish-eye lens. The image will have barrel distortion. Depending on the level of this filter effect, the area trimmed along the periphery of the image changes. Also, because this filter effect magnifies the center of the image, the apparent resolution at the center may degrade depending on the number of recorded pixels, so set the filter effect in step 4 while checking the resulting image.

-  **Art bold effect**

Makes the photo look like an oil painting and the subject look more three-dimensional. By adjusting the effect, you can change the contrast and saturation. Note that subjects such as the sky or white walls may not be rendered with a smooth gradation and may look irregular or have significant noise.



-  **Water painting effect**

Makes the photo look like a watercolor painting with soft colors. By adjusting the effect, you can change the color density. Note that night scenes or dark scenes may not be rendered with a smooth gradation and may look irregular or have significant noise.

-  **Toy camera effect**

Shifts colors to those typical of toy cameras and darkens the four corners of the image. Color tone options can be used to change the color cast.

-  **Miniature effect**

Creates a diorama effect. You can change where the image looks sharp. To switch between vertical and horizontal orientation of the sharp area (white frame), press <  > left or right in step 4 () , or tap [].

Resizing JPEG/HEIF Images

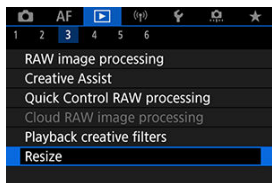

You can resize a JPEG or HEIF image to reduce the pixel count and save it as a new image. Resizing is available for **L**, **M**, or **S1** JPEGs or HEIFs (in sizes except **S2**), including those captured in RAW+JPEG and RAW+HEIF shooting. **S2** images and RAW images or movies cannot be resized.

1. Select []: Resize].



2. Select an image.



- Turn the <  > dial to select the image to resize.
- Press the <  > button to display the image size.

3. Select the desired image size.

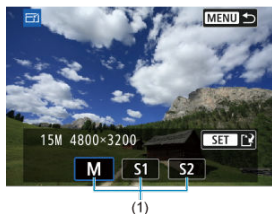

- Select the desired image size (1).

4. Save.

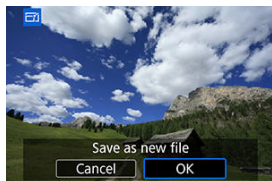

- Select [OK] to save the resized image.
- Check the destination folder and image file number, then select [OK].
- To resize another image, repeat steps 2 to 4.

Cropping JPEG/HEIF Images

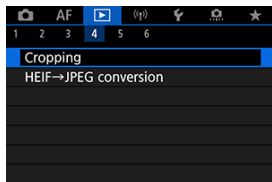

You can crop a captured JPEG image and save it as another image. Cropping is available for JPEG or HEIF images. RAW images and frame-grab images from 4K movies cannot be cropped.

1. Select []: Cropping].













2. Select an image.



- Turn the <  > dial to select the image to crop.
- Press the <  > button to display the cropping frame.



3. Set the cropping frame.



- The image area within the cropping frame will be cropped.
- **Resizing the cropping frame size**
Turn the <  > dial to resize the cropping frame size. The smaller the cropping frame, the more magnified the cropped image will look.
- **Correcting tilt**
You can correct image tilt by $\pm 10^\circ$. Turn the <  > dial to select [], then press the <  > button. While checking tilt relative to the grid, turn the <  > dial (in 0.1° increments) or tap the left or right arrow (in 0.5° increments) in the upper left of the screen to correct tilt. After correction is finished, press the <  > button.
- **Changing the cropping frame aspect ratio and orientation**
Turn the <  > dial and select []. Each press of the <  > button changes the cropping frame aspect ratio.
- **Moving the cropping frame**
Use <  > to move the cropping frame vertically or horizontally.



4. Check the image area to be cropped.







- Turn the <  > dial to select [], then press the <  > button. The image area to crop is displayed.

5. Save.



- Turn the <  > dial to select [], then press the <  > button.
- Select [**OK**] to save the cropped image.
- Check the destination folder and image file number, then select [**OK**].
- To crop another image, repeat steps 2 to 5.

Caution

- The position and size of the cropping frame may change depending on the angle set for tilt correction.
- Once a cropped image is saved, it cannot be cropped again or resized.
- AF point display information () and Dust Delete Data () will not be appended to the cropped images.
- Available aspect ratios vary depending on whether you use []: **Cropping**] or []: **Add cropping information**].

Converting HEIF to JPEG

You can convert HEIF images captured in HDR shooting and save them as JPEG images.

1. Select [▶]: HEIF→JPEG conversion].

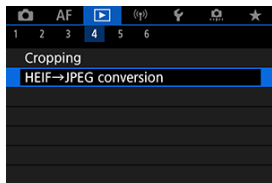

2. Select an image.

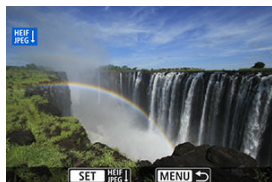

- Turn the <⦿> dial to select an HEIF image to convert to JPEG.
- Press the <Ⓜ> button to convert to JPEG.

3. Save.

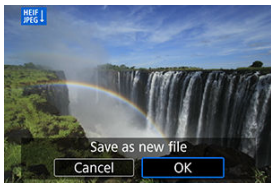

- Select **[OK]** to save the JPEG image.
 - Check the destination folder and image file number, then select **[OK]**.
 - To convert another image, repeat steps 2 and 3.

Note

- Some scenes may look different after conversion if the original and converted images are compared.
- Conversion is not available for cropped images, or for frame-grab images from 4K movies.

Slide Show

You can play back the images on the card as an automatic slide show.

1. Specify the images to be played back.

- To play back all the images on the card, go to step 2.
- If you want to specify the images to be played back in the slide show, filter the images with [▶]: **Set image search conditions** (🔍).

2. Select [▶]: **Slide show**.

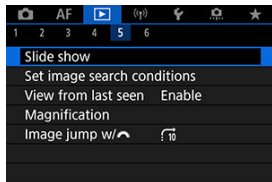

3. Set the playback as desired.

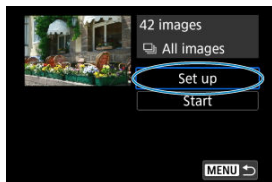

- Select [**Set up**].
- Set the [**Display time**] and [**Repeat**] (repeated playback) settings for the still photos.
- After completing the settings, press the <MENU> button.

Display time

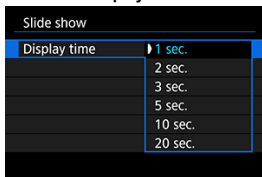

Repeat

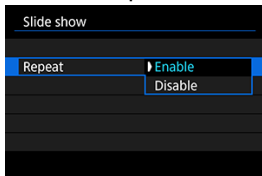

4. Start the slide show.

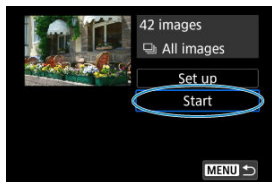







- Select [**Start**].
- After [**Loading image...**] is displayed, the slide show will start.

5. Exit the slide show.

- To exit the slide show and return to the setting screen, press the < **MENU** > button.

Note

- To pause the slide show, press the <  > button. During pause,  will be displayed in the upper left of the screen. Press the <  > button again to resume the slide show.
- During the automatic playback of still photos, you can press the < **INFO** > button to switch the display format ().
- Volume during movie playback can be adjusted by pressing the <  > <  > keys.
- During auto playback or when playback is paused, you can turn the <  > dial to view another image.
- During auto playback, auto power off will not take effect.
- The display time may differ depending on the image.

Setting Image Search Conditions

[Clearing the Search Conditions](#)

You can filter image display according to your search conditions. After setting the image search conditions, you can play back and display only the found images. You can also protect, rate, play a slide show, erase, and apply other operations to filtered images.

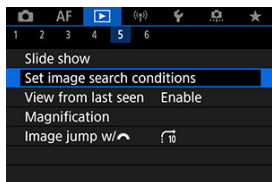

1. Select [: Set image search conditions].

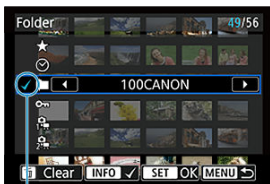

2. Set the search conditions.





(1)

- Turn the <  > dial to select an option.
- Turn the <  > dial to set the option.
- A checkmark [✓] (1) is appended to the left of the option. (Specified as the search condition.)
- If you select the option and press the < INFO > button, the checkmark [✓] will be removed (which cancels the search condition).

Option	Description
★ Rating	Displays images with the selected (rating) condition.
☑ Date	Displays images taken on the selected shooting date.
📁 Folder	Displays images in the selected folder.
🔒 Protect	Displays images with the selected (protect) condition.
📄 Type of file (1)	Displays images of the selected file type.
📄 Type of file (2)	

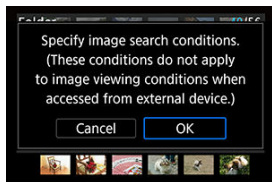
3. Apply the search conditions.



- Press the <  > button and read the message displayed.
- Select [OK].
The search condition is applied.

4. Display the found images.



(2)

- Press the <  > button.
Only the images that match the set conditions (filtered) will be played back.
When the images are filtered for display, the screen will have an outer yellow frame (2).

Caution

- If no images match the search conditions, pressing the <  > button in step 3 has no effect.



Note

- Search conditions may be cleared after operations involving camera power or card changes and editing, adding, or erasing images.
- Auto power off time may be extended while the []: **Set image search conditions**] screen is displayed.

Clearing the Search Conditions

Access the screen in step 2, then press the < > button to clear all the search conditions.

Resuming from Previous Playback

1. Select [▶]: View from last seen.

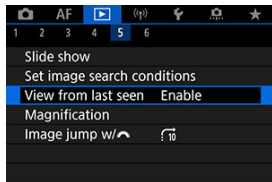

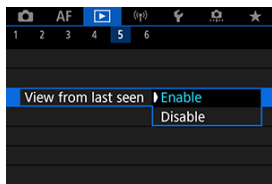

2. Select an option.



- **[Enable]**: Playback resumes from the last image displayed (unless you have just finished shooting).
- **[Disable]**: Playback resumes from your most recent shot whenever the camera is restarted.

Browsing Images with the Main Dial

In single-image display, you can turn the <  > dial to jump through the images forward or backward according to the jump method set.



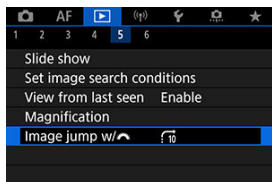

1. Select [: Image jump w/].

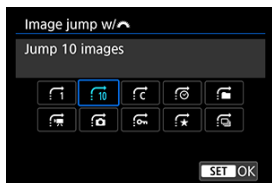

2. Select the jump method.





Note

- With [**Jump images by the specified number**], you can turn the <  > dial to select the number of images to jump by.
- With [**Display by image rating**], turn the <  > dial to select the rating (). Selecting  will show all rated images as you browse.

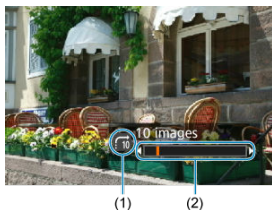
3. Browse by jumping.



- (1) Jump method
- (2) Playback position

- Press the <  > button.
- In single-image display, turn the <  > dial.
You can browse by the jump method set.

Note

- You can also change the jump method by pressing <  > left or right during playback.

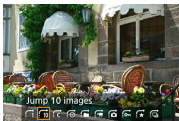

Customizing Playback Information Display

[Histogram](#)

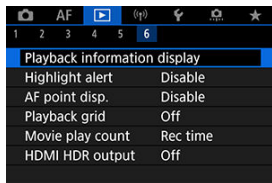

You can specify screens and accompanying information displayed during image playback.

1. Select []: Playback information display].

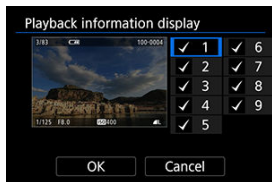

2. Add a checkmark [✓] next to the number of screens to display.



- Select numbers with the < > dial.
- Press the < > button to clear a checkmark [✓]. Press it again to add a checkmark [✓].
- Repeat these steps to add a checkmark [✓] to the number of each screen to display, then select [OK].
- Your selected information can be accessed by pressing the <INFO> button during playback, or by using < > when shooting information is displayed.

Histogram

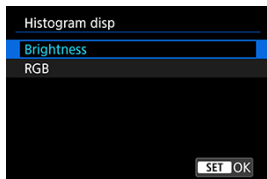

The histograms show signal levels across the tonal range. Brightness display (for checking the general exposure level and overall gradation) and RGB display (for checking saturation and gradation of red, green, and blue) are available. You can switch the histogram displayed by pressing the <INFO> button when [INFO] is displayed in the lower left of the [▶]: **Playback information display** screen.

- **[Brightness] display**

This histogram is a graph showing the distribution of the image's brightness level, with the horizontal axis indicating the brightness level (darker on the left and brighter on the right) and the vertical axis indicating the pixel count at each brightness level. The more pixels there are toward the left, the darker the image, and the more pixels there are toward the right, the brighter the image. If there are too many pixels on the left, detail in shadows will be lost, and if there are too many pixels on the right, detail in highlights will be lost. The gradation in-between will be reproduced. By checking the image and its brightness histogram, you can see the exposure level inclination and the overall gradation.

Sample histograms



Dark image



Normal brightness



Bright image

- **[RGB] display**

This histogram is a graph showing the distribution of each primary color's brightness level in the image (RGB or red, green, and blue), with the horizontal axis indicating the color's brightness level (darker on the left and brighter on the right) and the vertical axis indicating the pixel count at each color brightness level. The more pixels there are toward the left, the darker and less prominent the color, and the more pixels there are toward the right, the brighter and denser the color. If there are too many pixels on the left, the corresponding color information will be lacking, and if there are too many pixels on the right, the color will be too saturated, without gradation. By checking the image's RGB histogram, you can see the color's saturation and gradation conditions, as well as the white balance bias.

Displaying the Highlight Alert

You can specify blinking display of overexposed highlights on the playback screen. To obtain more detailed gradation in the blinking areas where you want the gradation to be faithfully reproduced, set the exposure compensation to a negative amount and shoot again for a better result.

1. Select [: Highlight alert].

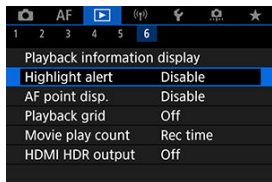

2. Select [Enable].

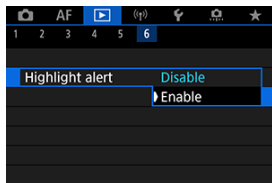

AF Point Display

You can display the AF points that were used to focus, which will be outlined in red on the playback screen.

1. Select [▶]: AF point disp.].

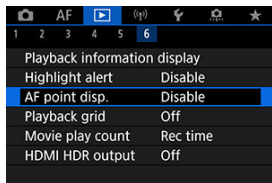

2. Select [Enable].

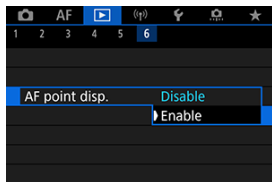

Playback Grid

You can display a grid over still photos shown in single-image display on the playback screen. This function is convenient for checking the image's vertical or horizontal tilt as well as composition.

1. Select [▶]: Playback grid].

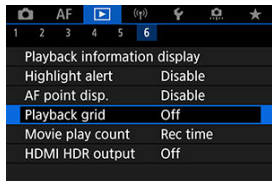

2. Select an option.

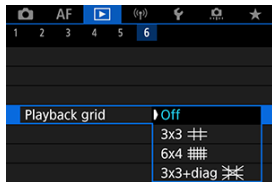

Note

- When panoramic images are displayed, a single vertical and horizontal line are shown if **[Playback grid]** is set to an option other than **[Off]**.



Movie Play Count

You can select how time is displayed on the movie playback screen.

1. Select [▶]: Movie play count].

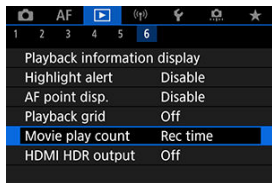

2. Select an option.

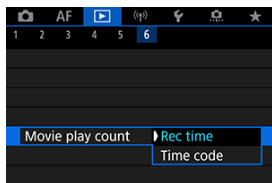

- **Rec time**

Displays the recording or playback time during movie playback.



- **Time code**

Displays the time code during movie playback.



Note

- Time codes are always recorded to movie files (except when High Frame Rate movies are set to **[Free run]**), regardless of the **[Movie rec count]** setting.
- The **[Movie play count]** setting in **[CAMERA]: Time code** is linked to the **[PLAYBACK]: Movie play count**, so that these settings always match.
- The “frame” count is not displayed during movie recording or playback.

Still Photo Extraction from RAW Burst Images



You can extract any image from the sets ("rolls," ) that are captured in RAW burst mode as a JPEG, HEIF, or RAW image.

1. Display the image.

- Press the <  > button.

2. Select a roll.



- Turn the <  > dial to select a roll.
- In single-image display, rolls are identified by a [SET ] icon in the upper left.
- In index display, press the <  > button to switch to single-image display.



Note

- Various settings may have a different effect on rolls than on extracted JPEG/HEIF images or on JPEG/HEIF images processed from extracted RAW images.

3. In single-image display, press the < > button.

4. Select **[PLAY]**.



- The roll is played.

5. Select an image.



- Turn the **< [DIAL] >** dial to select the image to extract.
- To delete unneeded portions at the beginning and end of the roll, press the **< [TRASH] >** button.

6. Press the **< [MENU] >** button.



7. Select an image format and save the extracted image.

- With **[Extract as JPEG]** or **[Extract as HEIF]**, you can choose **[Edit and save]** and apply RAW image processing (🔧) before saving.



Note

- Images are saved in **[L]** quality when you select **[Extract as JPEG]** or **[Extract as HEIF]**.
- Creative filters, cropping, and resizing are not available for JPEG/HEIF images extracted from RAW burst images or processed from extracted RAW images.
- HEIF images extracted from RAW burst images cannot be converted to JPEGs.

HDMI HDR Output

You can view RAW or HEIF images in HDR by connecting the camera to an HDR TV.

1. Select [▶]: HDMI HDR output].

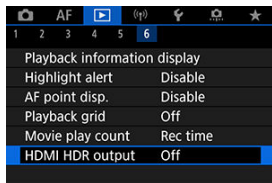

2. Select [On].

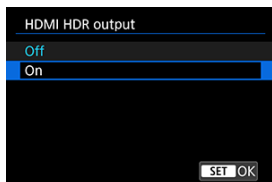

Note

- Make sure the HDR TV is set up for HDR input. For details on how to switch inputs on the TV, refer to the TV manual.
- Depending on the TV used, images may not look as expected.
- On HDR TVs, some information may not be displayed.
- Quick Control RAW processing of displayed images is recommended if you will process RAW images while viewing HDMI HDR output.

Wireless Features

This chapter describes how to connect the camera to a smartphone wirelessly via Bluetooth® or Wi-Fi® and send images to devices or Web services, how to control the camera from a computer or wireless remote control, and other operations.

Caution

Important

- Note that Canon cannot be held liable for any loss or damage caused by erroneous wireless communication settings when using the camera. In addition, Canon cannot be held liable for any other loss or damage caused by use of the camera. When using wireless communication functions, establish appropriate security at your own risk and discretion. Canon cannot be held liable for any loss or damage caused by unauthorized access or other security breaches.

- [Tab Menus: Wireless Features](#)
- [Wi-Fi/Bluetooth Connection](#)
- [Connecting to a Smartphone](#)
- [Connecting to a Computer via Wi-Fi](#)
- [Connecting to a Printer via Wi-Fi](#)
- [Sending Images to a Web Service](#)
- [Streaming Images](#)
- [Wi-Fi Connection via Access Points](#)
- [Connecting to a Wireless Remote Control](#)
- [Reconnecting via Wi-Fi/Bluetooth](#)
- [Registering Multiple Connection Settings](#)
- [Airplane Mode](#)
- [Wi-Fi Settings](#)
- [Bluetooth Settings](#)
- [Nickname](#)
- [GPS Device Settings](#)
- [Changing or Deleting Connection Settings](#)
- [Resetting Communication Settings](#)
- [View Info Screen](#)
- [Virtual Keyboard Operations](#)
- [Responding to Error Messages](#)
- [Wireless Communication Function Precautions](#)
- [Security](#)
- [Checking Network Settings](#)

- [Wireless Communication Status](#)

Tab Menus: Wireless Features

● Wireless features 1

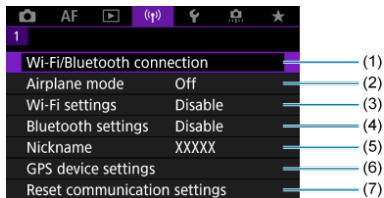

- (1) [Wi-Fi/Bluetooth connection](#)
- (2) [Airplane mode](#)
- (3) [Wi-Fi settings](#)
- (4) [Bluetooth settings](#)
- (5) [Nickname](#)
- (6) [GPS device settings](#)
- (7) [Reset communication settings](#)

! Caution

- Wireless communication is not available while the camera is connected via an interface cable to a computer or other device.
- Other devices, such as computers, cannot be used with the camera by connecting them with an interface cable while the camera is connected to devices via Wi-Fi.
- The camera cannot be connected via Wi-Fi if there is no card in the camera (except for [📷]). Also, for [📷] and Web services, the camera cannot be connected via Wi-Fi if there are no images saved on the card.
- The Wi-Fi connection will be terminated if you set the camera's power to < OFF >, or open the card slot cover or battery compartment cover.
- With a Wi-Fi connection established, the camera's auto power off does not function.

Wi-Fi/Bluetooth Connection

1. Select [(Wi-Fi/Bluetooth connection)].

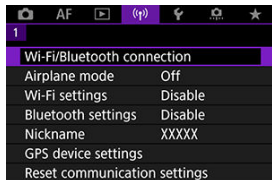

2. Select an option for the camera to connect to.

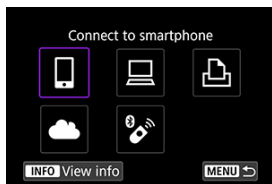

Connect to smartphone

Control the camera remotely and browse images on the camera over a Wi-Fi connection by using the dedicated Camera Connect app on smartphones or tablets (collectively referred to as “smartphones” in this manual).

After pairing the camera with a smartphone supporting Bluetooth low energy technology (hereafter, “Bluetooth”), you only need to use the smartphone to connect via Wi-Fi.

Remote control (EOS Utility)

Connect the camera to a computer via Wi-Fi and operate the camera remotely using EOS Utility (EOS software). Images on the camera can also be sent to the computer.

Print from Wi-Fi printer

Connect the camera to a printer supporting PictBridge (Wireless LAN) via Wi-Fi to print images.

Upload to Web service

Images can be sent directly from the camera to the image.canon cloud service for Canon customers after you complete member registration (free of charge). Original files of images sent to image.canon are retained for 30 days, without storage limitations, and can be downloaded to computers or transferred to other Web services.





Connect to Wireless Remote

This camera can also be connected to Wireless Remote Control BR-E1 (sold separately) via Bluetooth for remote control shooting.



Connecting to a Smartphone

- [!\[\]\(3da2b303d29c1ea489bbe26a3f5ac664_img.jpg\) Turning on Bluetooth and Wi-Fi on a Smartphone](#)
- [!\[\]\(9421cea5a5b5319f79b58962509475ab_img.jpg\) Installing Camera Connect on a Smartphone](#)
- [!\[\]\(17cce402a0380c36f25e02ecf91578f5_img.jpg\) Connecting to a Bluetooth-compatible Smartphone via Wi-Fi](#)
- [!\[\]\(1086da34995924f924c8e8e23387d139_img.jpg\) Camera Connect Functions](#)
- [!\[\]\(ffa6dd4cd8800071ccc1a355540c540c_img.jpg\) Maintaining a Wi-Fi Connection When the Camera Is Off](#)
- [!\[\]\(dfba61b58454dd961d978e324a1fb5e5_img.jpg\) Canceling the Pairing](#)
- [!\[\]\(9580d03b8c5bd7e23dc602a02886460d_img.jpg\) Wi-Fi Connection without Using Bluetooth](#)
- [!\[\]\(406c76dc95713637836155a54c3b56d5_img.jpg\) Automatic Image Transfer as You Shoot](#)
- [!\[\]\(b950fe96ed6737d8544db83990032195_img.jpg\) Sending Images to a Smartphone from the Camera](#)
- [!\[\]\(ec7b82925343491880a39b127070bd34_img.jpg\) Terminating Wi-Fi Connections](#)
- [!\[\]\(bb20e4cc9af9ca0b97fbe827353956b8_img.jpg\) Settings to Make Images Viewable from Smartphones](#)

You can do the following after pairing the camera with a Bluetooth-compatible smartphone.

- Establish a Wi-Fi connection using only the smartphone ().
- Establish a Wi-Fi connection with the camera even when it is off ().
- Geotag images with GPS information acquired by the smartphone ().
- Control the camera remotely from a smartphone ().

You can also do the following after connecting the camera to a smartphone via Wi-Fi.

- Browse and save images on the camera from a smartphone ().
 - Control the camera remotely from a smartphone ().
 - Send images to a smartphone from the camera ().
-

Turning on Bluetooth and Wi-Fi on a Smartphone

Turn on Bluetooth and Wi-Fi from the smartphone settings screen. Note that pairing with the camera is not possible from the smartphone's Bluetooth settings screen.



Note

- To establish a Wi-Fi connection via an access point, see [Wi-Fi Connection via Access Points](#).

Installing Camera Connect on a Smartphone

The dedicated app Camera Connect (free of charge) must be installed on the smartphone on which Android or iOS is installed.

- Use the latest version of the smartphone OS.
- Camera Connect can be installed from Google Play or App Store. Google Play or App Store can also be accessed using the QR codes that appear when the camera is paired or connected via Wi-Fi to a smartphone.



Note

- For the operating system versions supported by Camera Connect, refer to the download site of Camera Connect.
- Sample screens and other details in this guide may not match the actual user interface elements after camera firmware updates or updates to Camera Connect, Android, or iOS.

Connecting to a Bluetooth-compatible Smartphone via Wi-Fi

Steps on the camera (1)

1. Select [(P): Wi-Fi/Bluetooth connection].

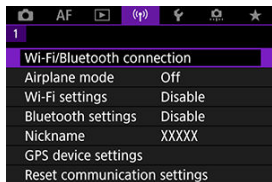

2. Select [☑Connect to smartphone].

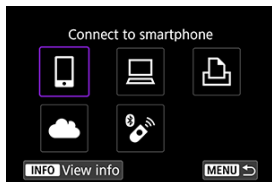

3. Select [Add a device to connect to].



4. Select an option.

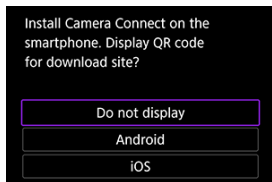

- If Camera Connect is already installed, select [**Do not display**].
- If Camera Connect is not installed, select [**Android**] or [**iOS**], scan the displayed QR code with the smartphone to access Google Play or App Store and install Camera Connect.

5. Select [Pair via Bluetooth].

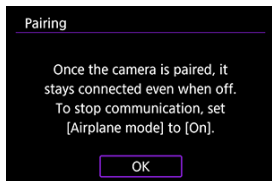

- Press the < > button to start pairing.

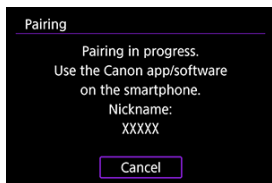

- To pair with a different smartphone after pairing with one initially, select [OK] on the screen shown above.

Steps on the smartphone (1)

6. Start Camera Connect.



7. Tap the camera for pairing.

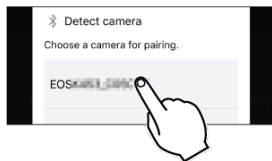

- In Android, go to [Steps on the camera \(2\)](#).

8. Tap [Pair] (iOS only).

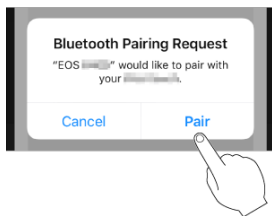

Steps on the camera (2)

9. Select [OK].

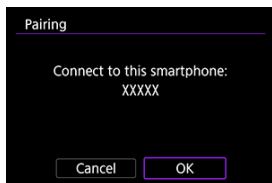

10. Press the < > button.

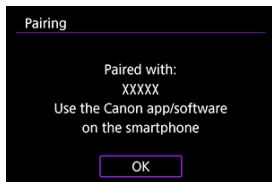

- Pairing is now complete, and the camera is connected to the smartphone via Bluetooth.

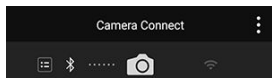

- A Bluetooth icon appears on the main Camera Connect screen.

 **Caution**

- The camera cannot be connected to two or more devices at the same time via Bluetooth. To switch to a different smartphone for the Bluetooth connection, see [Reconnecting via Wi-Fi/Bluetooth](#).
- Bluetooth connection consumes battery power even after the camera's auto power off is activated. Therefore, the battery level may be low when you use the camera.

Troubleshooting pairing

- Keeping pairing records for previously paired cameras on your smartphone will prevent it from pairing with this camera. Before you try pairing again, remove pairing records for previously paired cameras from your smartphone's Bluetooth settings screen.

 **Note**

- With a Bluetooth connection established, you can operate the camera to send images to the smartphone ().

Steps on the smartphone (2)

11. Tap a Camera Connect function.

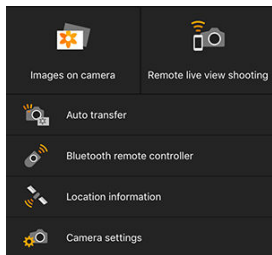

- In iOS, tap **[Join]** when a message is displayed to confirm camera connection.
- An error message may be displayed on the smartphone even if Camera Connect is connected. If so, close the error message and continue using the app.
- For the Camera Connect functions, see [Camera Connect Functions](#).
- When a Wi-Fi connection is established, the screen for the selected function will appear.

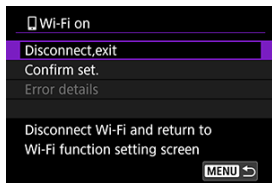

- **[Wi-Fi on]** is displayed on the camera screen.

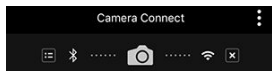

- The Bluetooth and Wi-Fi icons are lit on the main Camera Connect screen.

The Wi-Fi connection to a Bluetooth-compatible smartphone is now complete.

- For how to terminate the Wi-Fi connection, see [Terminating Wi-Fi Connections](#).
 - Terminating the Wi-Fi connection will switch the camera to the Bluetooth connection.
 - To reconnect via Wi-Fi, start Camera Connect and tap the function you will use.
- **[Wi-Fi on] screen**

Disconnect,exit

- Terminates the Wi-Fi connection.

Confirm set.

- You can check the settings.

Error details

- When a Wi-Fi connection error occurs, you can check the details of the error.

Images on camera

- Images can be browsed, deleted, or rated.
- Images can be saved on a smartphone.
- Effects can be applied to RAW images and saved to a smartphone ([Creative Assist](#)).

Remote live view shooting

- Enables remote shooting as you view a live image on the smartphone.

Auto transfer

- Enables camera and app setting adjustment for automatic transfer of your shots ()

Bluetooth remote controller

- Enables remote control of the camera from a smartphone paired via Bluetooth. (Not available when connected via Wi-Fi.)
- Auto power off is disabled while you are using the Bluetooth remote controller feature.

Location information

- Not supported on this camera.

Camera settings

- Camera settings can be changed.

Maintaining a Wi-Fi Connection When the Camera Is Off

Even when the camera power switch is set to <OFF>, as long as it is paired to a smartphone via Bluetooth, you can use the smartphone to connect via Wi-Fi and browse images on the camera or perform other operations.

If you prefer not to connect via Wi-Fi to the camera when it is off, either set [Airplane mode] to [On] or set [Bluetooth settings] to [Disable].

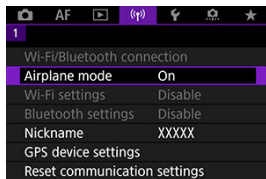

! Caution

- This function can no longer be used if the wireless settings are reset or the smartphone connection information is erased.

Canceling the Pairing

Cancel pairing with a smartphone as follows.

1. Select [(P): Wi-Fi/Bluetooth connection].

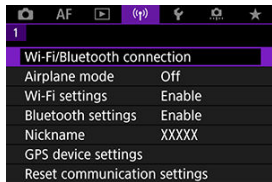

2. Select [☑ Connect to smartphone].

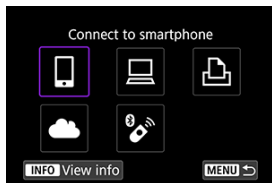

- If past connections (☑) are listed, turn the < Ⓞ > dial to switch screens.

3. Select [Edit/delete device].

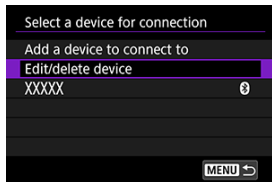

4. Select the smartphone to cancel pairing with.

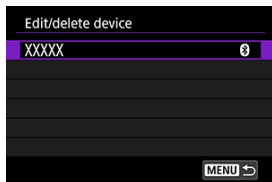

- Smartphones currently paired with the camera are labeled [📱].

5. Select [Delete connection information].

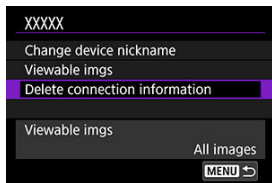

6. Select [OK].



7. Clear the camera information on the smartphone.

- In the smartphone's Bluetooth setting menu, clear the camera information registered on the smartphone.

Wi-Fi Connection without Using Bluetooth

Steps on the camera (1)

1. Select [(P): Wi-Fi/Bluetooth connection].

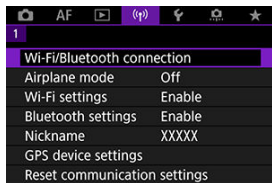

2. Select [☑ Connect to smartphone].

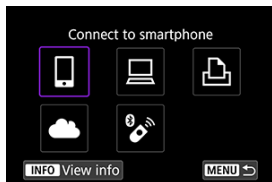

- If past connections (☑) are listed, turn the < Ⓞ > dial to switch screens.

3. Select [Add a device to connect to].



4. Select an option.

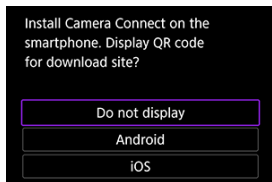

- If Camera Connect is already installed, select **[Do not display]**.

5. Select **[Connect via Wi-Fi]**.



6. Establish a Wi-Fi connection.

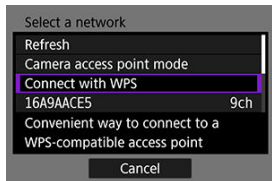

- Connect to an access point via Wi-Fi.

Steps on the smartphone

7. Operate the smartphone to establish a Wi-Fi connection.

Smartphone's screen (sample)

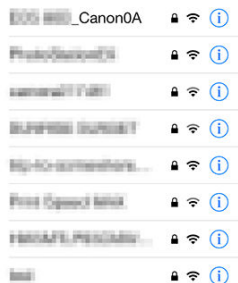

- Activate the smartphone's Wi-Fi function, then tap the SSID (network name) checked in step 6 in [Steps on the camera \(1\)](#).
- For the password, enter the password checked in step 6 in [Steps on the camera \(1\)](#).

8. Start Camera Connect and tap the camera to connect to via Wi-Fi.

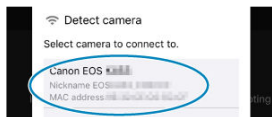

Steps on the camera (2)

9. Select [OK].

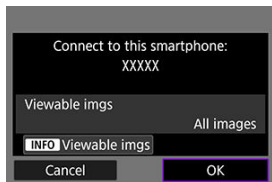

- To specify viewable images, press the <INFO> button. Configure as described in [Settings to Make Images Viewable from Smartphones](#), starting in step 5.

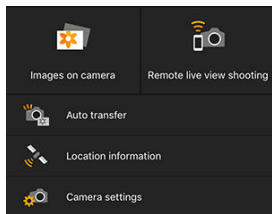

- The main window of Camera Connect will be displayed on the smartphone.

The Wi-Fi connection to a smartphone is now complete.

- Operate the camera using Camera Connect (📷).
- For how to terminate the Wi-Fi connection, see [Terminating Wi-Fi Connections](#).
- To reconnect via Wi-Fi, see [Reconnecting via Wi-Fi/Bluetooth](#).

Note

- When connected via Wi-Fi, you can send images to a smartphone from the Quick Control screen during playback (📷).

Automatic Image Transfer as You Shoot

Your shots can be automatically sent to a smartphone. Before following these steps, make sure the camera and smartphone are connected via Wi-Fi.

1. Select [(Wi-Fi): Wi-Fi settings].

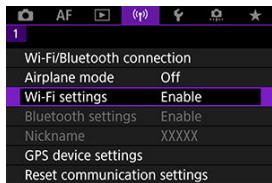

2. Select [Send to smartphone after shot].

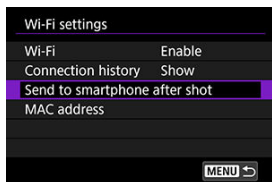

3. Set [Auto send] to [Enable].

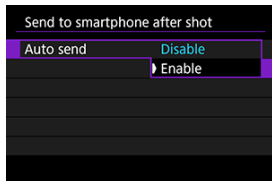

4. Set [Size to send].

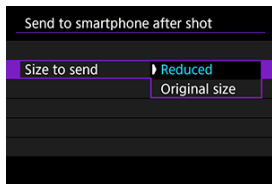

5. Take the picture.

Sending Images to a Smartphone from the Camera

You can use the camera to send images to a smartphone paired via Bluetooth (Android devices only) or connected via Wi-Fi.

1. Switch to playback.



2. Press the < [SET] > button.

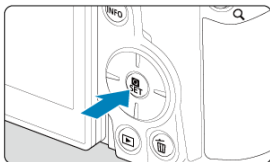

3. Select [[Smartphone] Send images to smartphone].

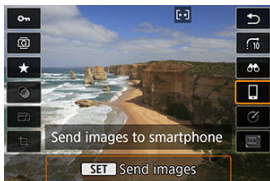



- If you perform this step while connected via Bluetooth, a message is displayed, and the connection switches to a Wi-Fi connection.

4. Select sending options and send the images.

(1) Sending images individually

1. Select an image to send.



- Turn the <  > dial to select an image to send, then press the <  > button.
- Images can be selected by touch from index display ().

2. Select [Send img shown].

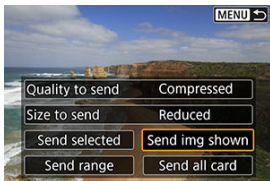

- In [**Size to send**], you can select the image sending size.
- When sending movies, you can select the image quality of movies to send in [**Quality to send**].

(2) Sending multiple selected images

1. Press the <  > button.



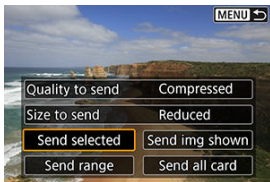

2. Select [Send selected].



3. Select images to send.



- Turn the <  > dial to select an image to send, then press the <  > button.

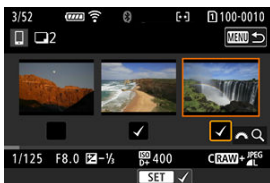

- Images can be selected by touch from three-image display ().
- After selecting the images to send, press the < MENU > button.

4. Select [Size to send].

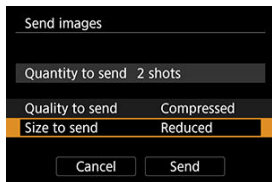

- On the displayed screen, select an image size.

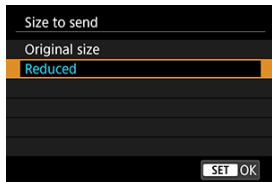

- When sending movies, select the image quality in [Quality to send].

5. Select [Send].

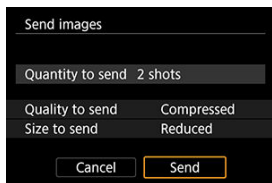

(3) Sending a specified range of images

1. Press the <  > button.



2. Select [Send range].

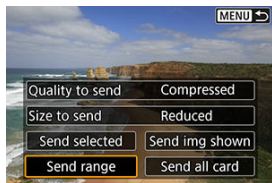

3. Specify the range of images.

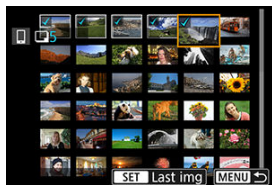

- Select the first image (start point).
- Select the last image (end point).
- To cancel the selection, repeat this step.
- You can change the number of images shown in index display for selection by touch ().

4. Confirm the range.

- Press the < MENU > button.

5. Select [Size to send].

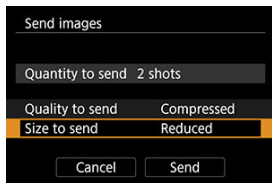

- On the displayed screen, select an image size.

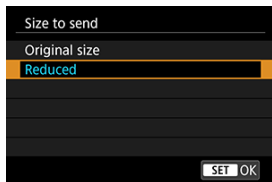

- When sending movies, select the image quality in [Quality to send].

6. Select [Send].

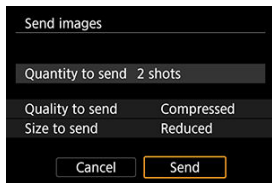

(4) Sending all images on the card

1. Press the <  > button.



2. Select [Send all card].

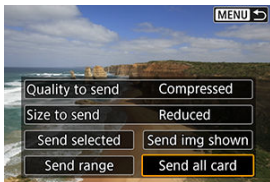

3. Select [Size to send].

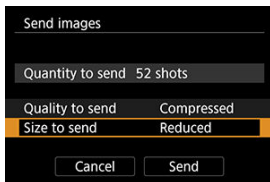

- On the displayed screen, select an image size.

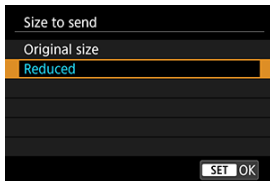

- When sending movies, select the image quality in [Quality to send].

4. Select [Send].

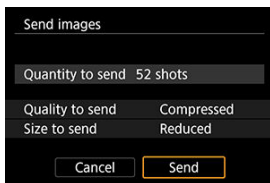

(5) Sending images that match the search conditions

Send all the images that match the search conditions set in [Set image search conditions] at once. For details on [Set image search conditions], see [Setting Image Search Conditions](#).

1. Press the <  > button.



2. Select [Send all found].

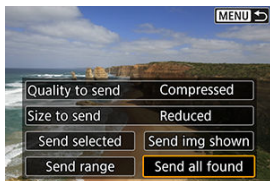

3. Select [Size to send].

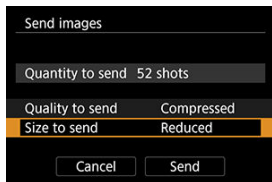

- On the displayed screen, select an image size.

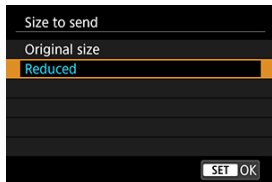

- When sending movies, select the image quality in [Quality to send].

4. Select [Send].

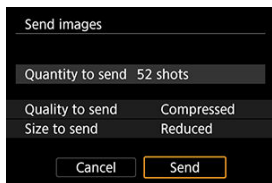

Ending image transfer

Sending images from the camera when paired via Bluetooth (Android devices only)



- Press the < MENU > button on the image transfer screen.



- Select [OK] to end image transfer and the Wi-Fi connection.

Sending images from the camera over a Wi-Fi connection



- Press the < MENU > button on the image transfer screen.
- To terminate the Wi-Fi connection, see [Terminating Wi-Fi Connections](#).

⚠ Caution

- During the image transfer operation, a picture cannot be taken even if the camera's shutter button is pressed.

 **Note**

- You can cancel the image transfer by selecting **[Cancel]** during the transfer.
- You can select up to 999 files at a time.
- With a Wi-Fi connection established, disabling the smartphone's power saving function is recommended.
- Selecting the reduced size for still photos applies to all still photos sent at that time. Note that **S2** size still photos are not reduced.
- Selecting compression for movies applies to all movies sent at that time. Note that **FHD 29.97P (1PB)** and **FHD 25.00P (1PB)** movies are not reduced.
- When you use a battery to power the camera, make sure it is fully charged.

Terminating Wi-Fi Connections

Perform either of the following operations.

On the Camera Connect screen, tap [X].

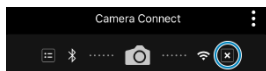

On the [Wi-Fi on] screen, select [Disconnect,exit].

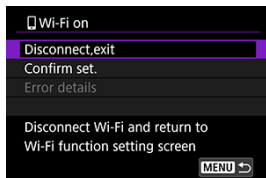

- If the [Wi-Fi on] screen is not displayed, select [(⌂): Wi-Fi/Bluetooth connection].
- Select [Disconnect,exit], then select [OK] on the confirmation screen.

Settings to Make Images Viewable from Smartphones

Images can be specified after the Wi-Fi connection is terminated.

1. Select [(P): Wi-Fi/Bluetooth connection].

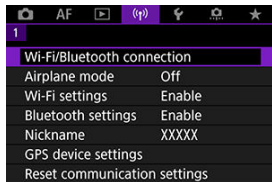

2. Select [☑ Connect to smartphone].

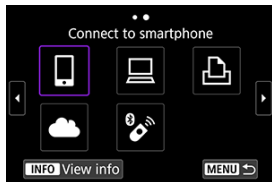

- If past connections (☑) are listed, turn the <☉> dial to switch screens.

3. Select [Edit/delete device].

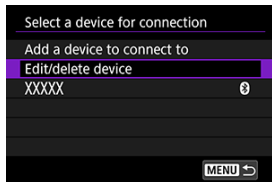

4. Select a smartphone.

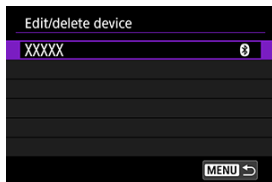

- Select the name of the smartphone on which you want to make the images viewable.

5. Select [Viewable imgs].

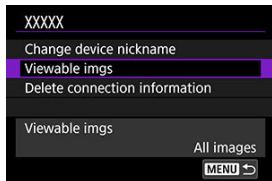

6. Select an option.

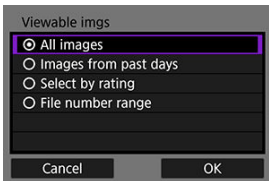



- Select **[OK]** to access the setting screen.

[All images]

- All images stored on the card become viewable.

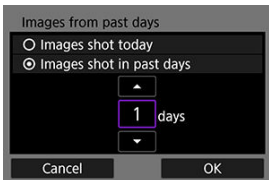
[Images from past days]



- Specify viewable images on the shooting-date basis. Images shot up to nine days ago can be specified.
- When **[Images shot in past days]** is selected, images shot up to the specified number of days before the current date become viewable. Turn the  dial to specify the number of days, then press the  button to confirm the selection.
- Once you select **[OK]**, the viewable images are set.

Caution

- If **[Viewable imgs]** is set to any setting other than **[All images]**, remote shooting is not possible.

[Select by rating]

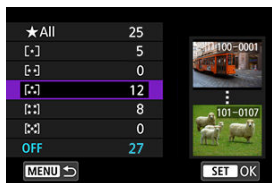

- Specify viewable images depending on whether a rating is appended (or not appended) or by the type of rating.
- Once you select the type of rating, the viewable images are set.

[File number range] (Select range)

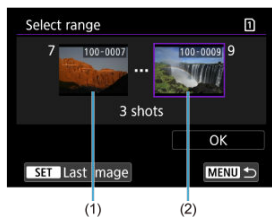

- Select the first and last images from images arranged by the file number to specify the viewable images.
 1. Press the < [Image] > button to display the image selection screen. Turn the < [Dial] > dial to select the image. Images can be selected by touch from index display ([Image]).
 2. Select an image as the starting point (1).
 3. Turn the < [Dial] > dial and select an image as the ending point (2).
 4. Select [OK].

 **Caution**

- If the Wi-Fi connection is terminated while recording a movie with remote shooting, the following will occur.
 - Any movie recording in progress in movie recording mode will continue.
 - Any movie recording in progress in still photo shooting mode will end.
- With a Wi-Fi connection to a smartphone established, certain functions are unavailable.
- In remote shooting, the AF speed may become slower.
- Depending on the communication status, image display or shutter release timing may be delayed.
- When saving images to a smartphone, you cannot take a picture even if you press the camera's shutter button. Also, the camera screen may turn off.

 **Note**

- With a Wi-Fi connection established, disabling the smartphone's power saving function is recommended.

Connecting to a Computer via Wi-Fi

[Operating the Camera Using EOS Utility](#)

This section describes how to connect the camera to a computer via Wi-Fi and perform camera operations using EOS software or other dedicated software. Install the latest version of software on the computer before setting up a Wi-Fi connection.

For computer operating instructions, refer to the computer user manual.

Operating the Camera Using EOS Utility

Using EOS Utility (EOS software), you can import images from the camera, control the camera, and perform other operations.

Steps on the camera (1)

1. Select []: Wi-Fi/Bluetooth connection].

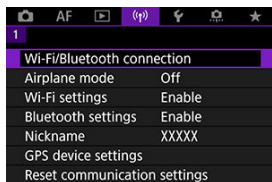

2. Select [] Remote control (EOS Utility)].

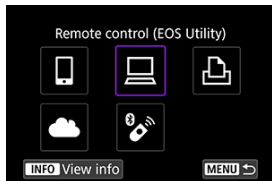

- If past connections () are listed, turn the <  > dial to switch screens.

3. Select [Add a device to connect to].



4. Check the SSID (network name) and password.

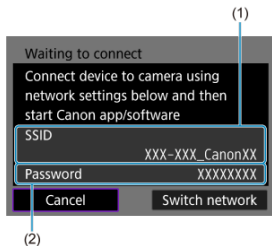

- Check the SSID (1) and Password (2) displayed on the camera screen.

Steps on the computer (1)

5. Select the SSID, then enter the password.

Computer's screen (sample)

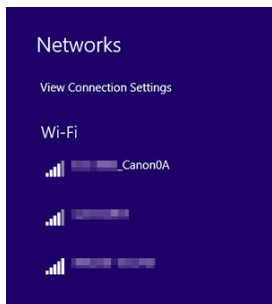

- On the computer's network setting screen, select the SSID checked in step 4 in [Steps on the camera \(1\)](#).
- For the password, enter the password checked in step 4 in [Steps on the camera \(1\)](#).

Steps on the camera (2)

6. Select [OK].

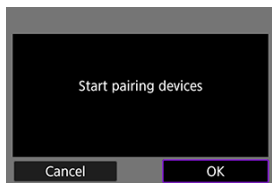

- The following message is displayed. "*****" represents the last six digits of the MAC address of the camera to be connected.

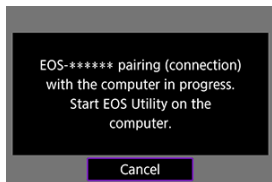

Steps on the computer (2)

7. Start EOS Utility.

8. In EOS Utility, click [Pairing over Wi-Fi/LAN].



- If a firewall-related message is displayed, select [Yes].

9. Click [Connect].

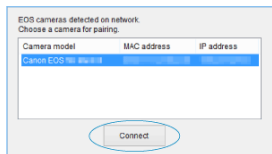

- Select the camera to connect to, then click [Connect].

Steps on the camera (3)

10. Establish a Wi-Fi connection.

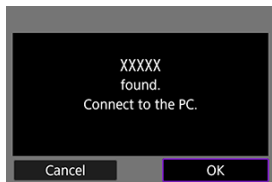

- Select [OK].

[Wi-Fi on] screen

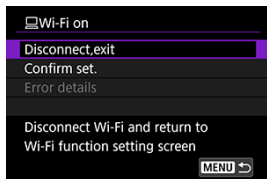

Disconnect,exit

- Terminates the Wi-Fi connection.

Confirm set.

- You can check the settings.

Error details

- When a Wi-Fi connection error occurs, you can check the details of the error.

The Wi-Fi connection to a computer is now complete.

- Operate the camera using EOS Utility on the computer.
- To reconnect via Wi-Fi, see [Reconnecting via Wi-Fi/Bluetooth](#).

Caution

- If the Wi-Fi connection is terminated while recording a movie with remote shooting, the following will occur.
 - Any movie recording in progress in movie recording mode will continue.
 - Any movie recording in progress in still photo shooting mode will end.
- You cannot use the camera to shoot in still photo shooting mode when it is set to movie recording mode in EOS Utility.
- With a Wi-Fi connection to EOS Utility established, certain functions are unavailable.
- In remote shooting, the AF speed may become slower.
- Depending on the communication status, image display or shutter release timing may be delayed.
- In Remote Live View shooting, the rate of image transmission is slower compared to a connection via an interface cable. Therefore, moving subjects cannot be displayed smoothly.

Connecting to a Printer via Wi-Fi

 [Image Printing](#)

 [Print Settings](#)

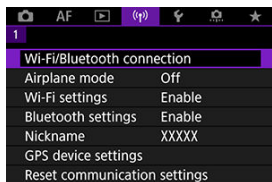

This section describes how to print images by directly connecting the camera to a printer supporting PictBridge (Wireless LAN) via Wi-Fi. For printer operating instructions, refer to the printer user manual.

1. Select []: Wi-Fi/Bluetooth connection].

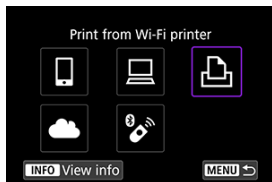

2. Select [] Print from Wi-Fi printer].



- If past connections () are listed, turn the  dial to switch screens.

3. Select [Add a device to connect to].

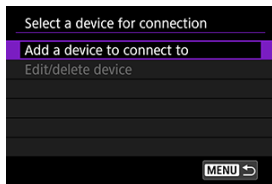

4. Check the SSID (network name) and password.

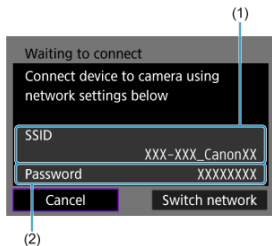

- Check the SSID (1) and Password (2) displayed on the camera screen.

5. Set up the printer.

- In the Wi-Fi settings menu of the printer to be used, select the SSID you have checked.
- For the password, enter the password checked in step 4.

6. Select the printer.

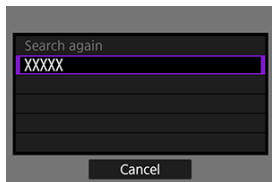

- In the list of detected printers, select the printer to connect to via Wi-Fi.
- If your preferred printer is not listed, selecting [**Search again**] may enable the camera to find and display it.





Note

- To establish a Wi-Fi connection via an access point, see [Wi-Fi Connection via Access Points](#).

Printing images individually

1. Select the image to be printed.



- Turn the <  > dial to select an image to print, then press the <  > button.
- Images can be selected by touch from index display ().

2. Select [Print image].



3. Print the image.



- For the print setting procedures, see [Print Settings](#).
- Select [**Print**], then [**OK**] to start printing.

Printing according to specified image options

1. Press the <  > button.



2. Select [Print order].



3. Set the printing options.

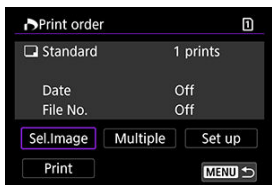

- For the print setting procedures, see [Print Ordering \(DPOF\)](#).
- If the print order is complete before establishing a Wi-Fi connection, go to step 4.

4. Select [Print].

- [Print] can be selected only when an image is selected and the printer is ready to print.

5. Configure [Paper settings] (📄).

6. Print the image.

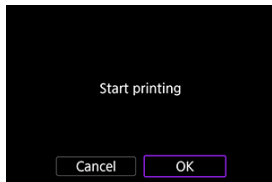

- When [OK] is selected, printing starts.

⚠ Caution

- Shooting is not possible while connected to a printer via Wi-Fi.
- RAW images, HEIF images, and movies cannot be printed.
- Before printing, be sure to set the paper size.
- File number printing may not be supported by certain printers.
- Dates may be printed on the border by certain printers when [Bordered] is set.
- Depending on the printer, the date may appear faint if it is printed on a bright background or on the border.



Note

- When you use a battery to power the camera, make sure it is fully charged.
- It may take some time until printing starts after you select [**Print**], depending on file size and image quality.
- To stop printing, press the <  > button while [**Cancel**] is displayed, then select [**OK**].
- When printing with [**Print order**], you can select [**Resume**] to continue printing the remaining images if you have stopped printing in progress. Note that printing will not resume if any of the following occurs.
 - You change the print order or delete any of the specified images before resuming printing.
 - When index is set and you change the paper setting before resuming printing.
- If a problem occurs during printing, see [Notes](#).

Print Settings

The screen display and setting options vary depending on the printer. Also, certain settings may not be available. For details, refer to the printer's instruction manual.

Print settings screen



- (1) Sets date or file number printing (🔗).
- (2) Sets the printing effects (🔗).
- (3) Sets the number of copies to print (🔗).
- (4) Sets the print area (🔗).
- (5) Sets the paper size, type, and layout (🔗, 🔗, 🔗).
- (6) Returns to the image selection screen.
- (7) Starts the printing.
- (8) The paper size, type, and layout you have set are displayed.

* Depending on the printer, certain settings may not be selectable.

Paper settings

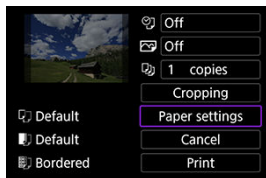

- Select [**Paper settings**].

[] Setting the paper size

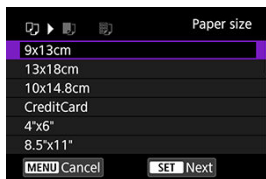

- Select the size of the paper in the printer.

[] Setting the paper type

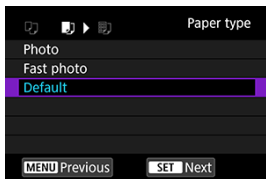

- Select the type of the paper in the printer.

[] Setting the page layout

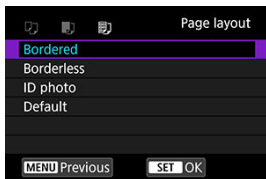

- Select the page layout.

Caution

- If the image's aspect ratio is different from the printing paper's aspect ratio, the image may be cropped significantly when you print it as a borderless print. Images may also be printed at lower resolution.

[] Setting printing of the date/file number

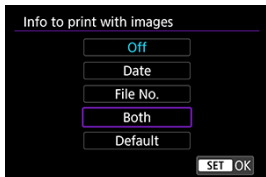

- Select [].
- Select what to print.

Setting printing effects (image optimization)

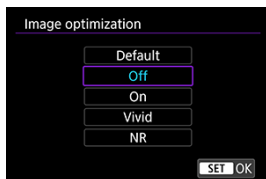

- Select .
- Select printing effects.

Caution

- ISO speeds may be misidentified in shooting information printed for images shot at an expanded ISO speed (H).
- **[Default]** in printing effects and other options refers to default settings determined by the printer manufacturer. For **[Default]** details, refer to the printer instruction manual.

Setting the number of copies



- Select .
- Select the number of copies to print.

Cropping the image

Set cropping immediately before printing. Changing other print settings after you crop images may require you to crop the images again.

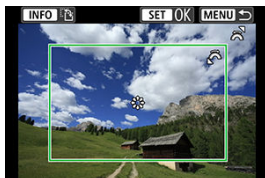

1. Select **[Cropping]** on the print setting screen.
2. Set the cropping frame size, position, and orientation.
 - The image area within the cropping frame will be printed. The shape of the frame (aspect ratio) can be changed in **[Paper settings]**.

Resizing the cropping frame size

Turn the <  > dial to resize the cropping frame size.

Moving the cropping frame

Press <  > to move the frame vertically or horizontally.

Switching the orientation of the cropping frame

Pressing the < **INFO** > button will toggle the cropping frame between the vertical and horizontal orientations.

3. Press the <  > button to exit cropping.

- You can check the cropped image area in the upper left of the print setting screen.

Caution

- Depending on the printer, the cropped image area may not be printed as you specified.
- The smaller the cropping frame, the lower the resolution at which images are printed.

 **Note****Handling printer errors**

- If printing does not resume after you resolve a printer error (such as no ink or paper) and select [**Continue**], use buttons on the printer. For details on resuming printing, refer to the printer's instruction manual.

Error messages

- If a problem occurs during printing, an error message will appear on the camera screen. After fixing the problem, resume printing. For details on how to fix a printing problem, refer to the printer's instruction manual.

Paper error

- Confirm that paper is loaded correctly.

Ink error

- Check the printer's ink level and the waste ink tank.

Hardware error

- Check for any printer problems other than paper and ink problems.

File error

- The selected image cannot be printed. Images taken with a different camera or images edited with a computer may not be printable.

Sending Images to a Web Service

[Connecting to image.canon](#)

[Automatic Image Transfer](#)

This section describes how to send images to image.canon.

Connecting to image.canon

Link the camera to image.canon to send images directly from the camera.

- A smartphone with a browser and internet connection is required.
- For instructions on how to use image.canon services and details on countries and regions where it is available, visit the image.canon site (<https://image.canon/>).
- Separate ISP connection and access point fees may apply.

Steps on the camera (1)

1. Select [**(P)**: Wi-Fi/Bluetooth connection].

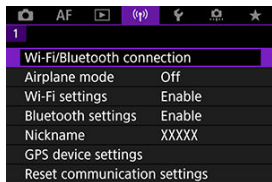

2. Select [**☁**: Upload to image.canon].

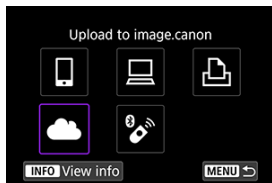

3. Select [Connect].

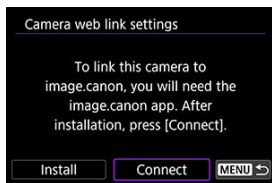

4. Select [OK].

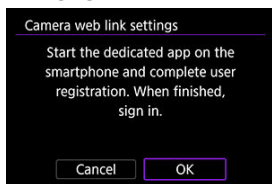

5. Scan the QR code with the dedicated app.



- Select [OK].

6. Establish a Wi-Fi connection.

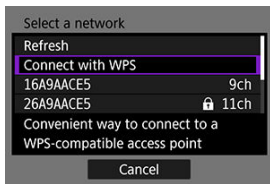

- Connect to an access point via Wi-Fi. Go to step 6 in [Wi-Fi Connection via Access Points](#).

7. Confirm that the number is displayed in the dedicated app.

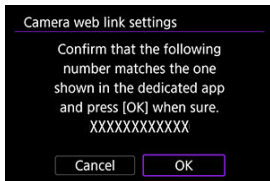

- Select [OK].

8. Select [OK].

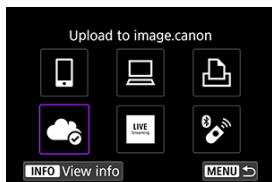
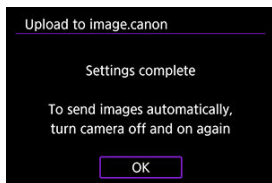

- The [☁️] icon changes to [☁️✔️].

Steps on the computer or smartphone

9. Set up camera web link.

- Follow the instructions to complete the settings on the camera web link settings page.

Automatic Image Transfer

Images are automatically uploaded to image.canon after the camera starts up (or recovers from auto power off). Original files of images sent to image.canon are retained for 30 days, without storage limitations, and can be downloaded to computers or transferred to other Web services.

- Uploading is not possible during interval timer shooting.

1. Select [(Wi-Fi): Wi-Fi/Bluetooth connection].

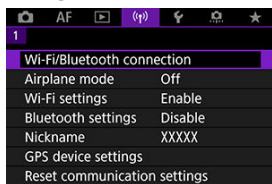

2. Select [(Upload to image.canon)].

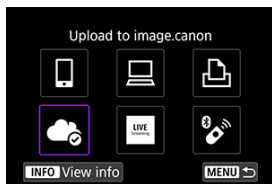

- If past connections (☑) are listed, turn the <⊙> dial to switch screens.

3. Set [Auto send] to [Enable].

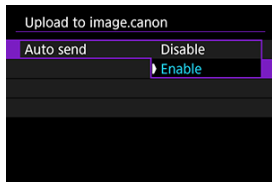

4. Set [Type to send].

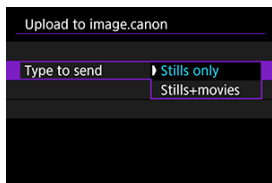

- In [**Type to send**], you can select the type of images that uploading applies to.

Streaming Images

 [Preparing to Stream](#)

 [Live Streaming](#)

You can live-stream images from the camera.

Only when streaming, you can use Wireless Remote Control BR-E1 (sold separately). Note that before streaming, you will need to pair the camera with Wireless Remote Control BR-E1 ()

Caution

- Check the YouTube streaming requirements in advance on the YouTube site.

Preparing to Stream

Set up “Live streaming” on the camera to enable streaming from the camera.

- Register the camera for [image.canon](#) and complete camera link settings as described in [Connecting to image.canon](#).
- Complete the required streaming settings on the YouTube site.
- For instructions, visit the YouTube site.

Steps on the computer or smartphone

1. Enable YouTube streaming.

- Display the settings screen for connected Web services used with [image.canon](#).
- Next to [YouTube], click or tap [Connect].
- Sign in to YouTube and allow [image.canon](#) access.

Steps on the camera



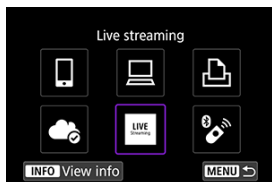

2. Connect to image.canon.



- For instructions on connecting to image.canon, see [Connecting to image.canon](#).
- A **[Live streaming]** icon is added once the camera is connected to image.canon.
- If the **[Live streaming]** icon does not work, see [Steps on the computer or smartphone](#) and check the YouTube settings. After setup, selecting **[Live streaming]** activates the icon.

Caution

Streaming

- YouTube is the only streaming service supported by this camera.
- Before you can use streaming services, you must complete image.canon registration.
- YouTube streaming is subject to change, suspension, or termination without prior notice.
- Canon is in no way responsible for third-party services such as YouTube streaming.
- No image is recorded to the card during streaming (but a card must be in the camera).
- Images are streamed at approx. 6 Mbps for either **FHD 29.97P** (NTSC) or **FHD 25.00P** (PAL).
- Images are streamed horizontally, regardless of the [: Add  rotate info] setting.
- Audio may be noisy during streaming. Check for noisy audio in advance by using [**PRVW**] () , for example. If noise from the external microphone is distracting, try placing it on the left side of the camera (on the < **MIC** > external microphone IN terminal side) as far from the camera as possible.
- It is not possible to pair the camera with Wireless Remote Control BR-E1 (sold separately, ) after you have set up streaming.
- Wireless Remote Control BR-E1 cannot be used while connected to the camera via Wi-Fi unless you are streaming.
- Remote control from a smartphone is not possible during streaming.

Live Streaming

You can also stream by using the camera to select an event that you have set up in advance on the YouTube site (by entering the streaming time and title).

1. Complete event settings on the YouTube site.

- For instructions, visit the YouTube site.



2. Setting the power switch to < >.

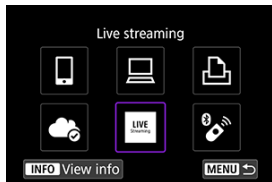

- You can select a movie recording mode () .

3. Start streaming.



- On the [(1): **Wi-Fi/Bluetooth connection**] screen, select [**Live streaming**].
- If past connections () are listed, turn the <  > dial to switch screens.

4. Check the terms of service.

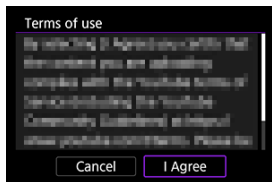

- Read the agreement displayed and choose [**I Agree**].

5. Select an event.

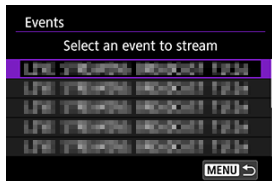

- Select an event that you have added from the YouTube site in advance.
- Up to 20 events are listed.



Note

- In case of messages indicating that streaming cannot be started, the event has not been registered yet. Add the event from the YouTube site.

6. Check the streaming details.

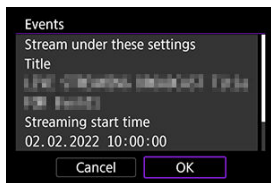

- Select [OK].

7. Select [OK].

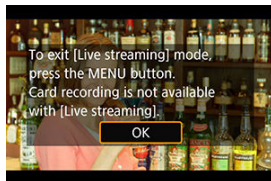

8. Select [PRVW] or [LIVE].

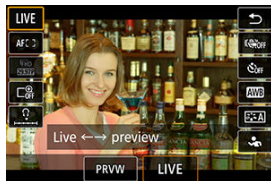

- Selecting [PRVW] (Preview) enables you to test streaming without releasing images publicly. Useful for checking images before streaming.
- Selecting [LIVE] (Live) enables you to start streaming immediately.

9. Start previewing or streaming.

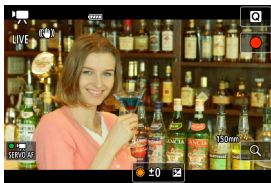

- Configure recording features, just as in normal movie recording.
- When ready, press the movie shooting button.
- Previewing or streaming starts automatically after **[Preparing preview]** or **[Preparing to stream]** is displayed.



- **[●PRVW]** or **[●LIVE]** is displayed in the upper right during previewing or streaming, respectively.
- The time that has elapsed since you pressed the movie shooting button is shown on the previewing/streaming screen (1). For streaming, the number of viewers is also displayed (2).
- Check the YouTube site to see how the streamed image looks.

10. Stop previewing or streaming.

- Press the movie shooting button again to stop previewing or streaming.
- After previewing the image, return to step 8 and select **[LIVE]** to start streaming.

11. Exit streaming mode.

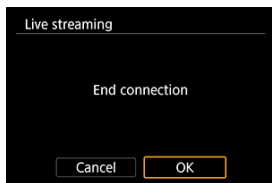

- Press the < MENU > button, then select [OK].

! Caution

- It will take a moment before streaming begins in step 9. Do not operate the camera while the message is displayed.
- In case of display problems (character corruption) on the camera for text you entered on the YouTube site, enter the text again from the YouTube site in ASCII format (single-byte letters or numbers).

Wi-Fi Connection via Access Points

 [Camera Access Point Mode](#)

 [Manual IP Address Setup](#)

This section describes how to join a Wi-Fi network via an access point compatible with WPS (PBC mode).

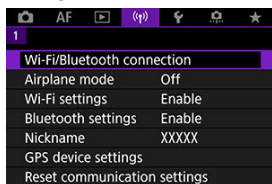

First, check the position of the WPS button and how long to press it. It may take approx. 1 min. to establish a Wi-Fi connection.

1. Select [>: Wi-Fi/Bluetooth connection].

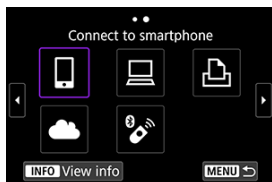

2. Select an option.



- If past connections () are listed, turn the  dial to switch screens.

3. Select [Add a device to connect to].



- The following message is displayed if you have selected [ **Connect to smartphone**]. If Camera Connect is already installed, select [**Do not display**].

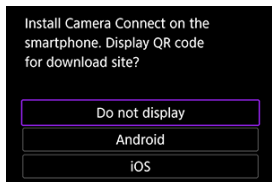

- On the [**Connect to smartphone**] screen displayed next, select [**Connect via Wi-Fi**].

4. Select [Switch network].

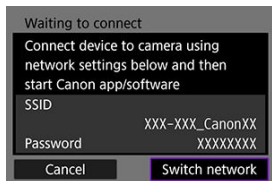

- Displayed when [], [], or [] is selected.

5. Select [Connect with WPS].

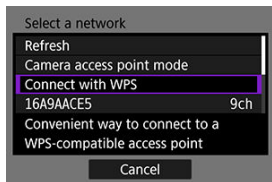

Note

- For [Camera access point mode] displayed in step 5, see [Camera Access Point Mode](#).

6. Select [WPS (PBC mode)].

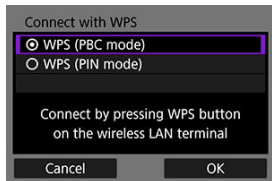

- Select [OK].

7. Connect to the access point via Wi-Fi.

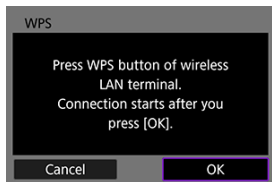

- Press the access point's WPS button.
- Select **[OK]**.

8. Select **[Auto setting]**.

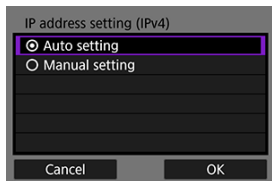

- Select **[OK]** to access the setting screen for the Wi-Fi function.
- If an error occurs with **[Auto setting]**, see [Manual IP Address Setup](#).

9. Specify the settings for the Wi-Fi function.

[📱Connect to smartphone]

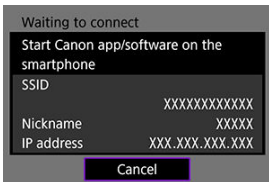

- On the smartphone's Wi-Fi setting screen, tap the SSID (network name) shown on the camera screen, then enter the password of the access point for the connection.

Go to step 7 in [Wi-Fi Connection without Using Bluetooth](#).

[🖨️Remote control (EOS Utility)]

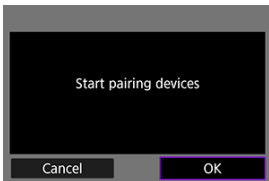

Go to step 7 or 8 in [Steps on the computer \(2\)](#).

[🖨️Print from Wi-Fi printer]

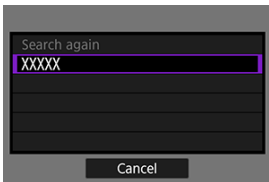

Go to step 6 in [Connecting to a Printer via Wi-Fi](#).

Register image.canon.

Go to step 5 in [Connecting to image.canon](#).

Camera Access Point Mode

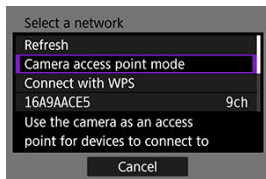

Camera access point mode is a connection mode for connecting the camera directly to each device via Wi-Fi. Displayed when [📺], [🖨️], or [📄] is selected after [(📶): Wi-Fi/Bluetooth connection].

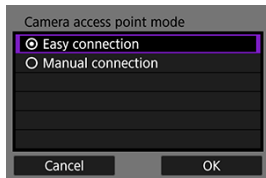

- **Easy connection**

Use the other device to establish a Wi-Fi connection with the SSID shown on the camera screen.

- **Manual connection**

Enter the SSID of the other device to establish a connection. Follow the instructions on the camera screen to complete the connection settings.

⚠ Caution

- Some printers may not be able to connect when the camera is used as an access point. If connection in camera access point mode is not possible, you may be able to establish a connection as follows.
 - Establish a Wi-Fi connection via an access point
 - Start access point mode on the printer

Manual IP Address Setup

The options displayed vary depending on the Wi-Fi function.

1. Select [Manual setting].

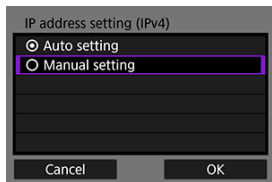

- Select [OK].

2. Select an option.

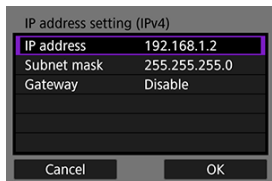

- Select an option to access the screen for numerical input.
- To use a gateway, select [Enable], then select [Address].

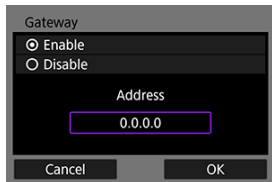

3. Enter the number.

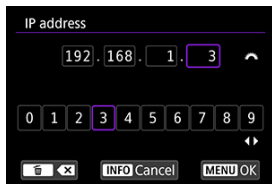

- Turn the dial to move the input position in the upper area, and use the keys to select numbers to enter. Press the button to enter the selected number.
- To delete the number just entered, press the button.
- Select **[OK]** after the numbers have been entered. Display returns to the screen in step 2.

4. Select [OK].

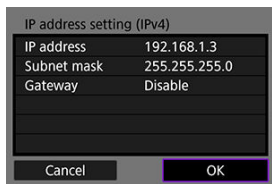

- When you have completed setting the necessary items, select **[OK]**.
- If you are not sure what to enter, see [Checking Network Settings](#), or ask the network administrator or another person knowledgeable about the network.

Connecting to a Wireless Remote Control

[Canceling the Pairing](#)

This camera can also be connected to Wireless Remote Control BR-E1 (sold separately, ) via Bluetooth for remote control shooting.

1. Select []: **Wi-Fi/Bluetooth connection**].

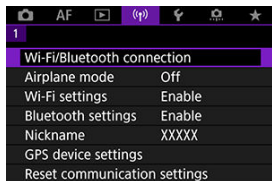

2. Select [] **Connect to Wireless Remote**].

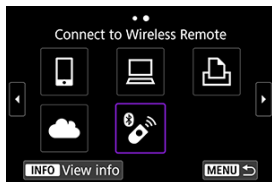

3. Select [**Add a device to connect to**].

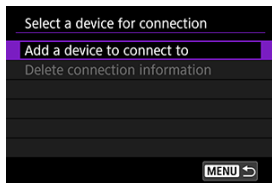

4. Press the <  > button.





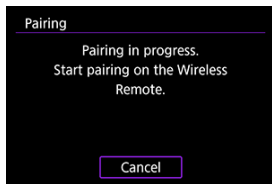

5. Pair the devices.



- When the [Pairing] screen appears, press and hold the <W> and <T> buttons on the BR-E1 simultaneously for at least 3 sec.
- After a message confirms that the camera is paired with the BR-E1, press the <  > button.

6. Set up the camera for remote shooting.

- When shooting still photos, select [] or [] as the drive mode ().
- For movie recording, set [: Remote control] to [Enable].
- For instructions after the pairing is complete, refer to the BR-E1's Instruction Manual.

 Caution

- Bluetooth connections consume battery power even after the camera's auto power off is activated.



Note

- When you will not use Bluetooth, setting **[Bluetooth settings]** to **[Disable]** is recommended (🔗).

Canceling the Pairing

Before pairing with a different BR-E1, clear the information about the connected remote control.

1. Select [**Wi-Fi/Bluetooth connection**].

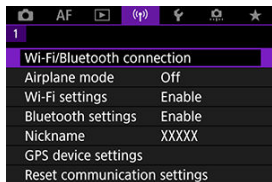

2. Select [**Connect to Wireless Remote**].

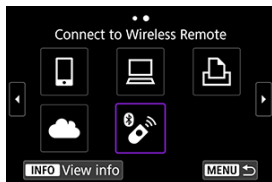

3. Select [**Delete connection information**].

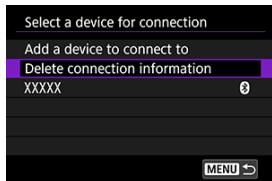

4. Select [OK].



Reconnecting via Wi-Fi/Bluetooth

Follow these steps to reconnect to devices or Web services with registered connection settings.

1. Select [(Ⓜ): Wi-Fi/Bluetooth connection].

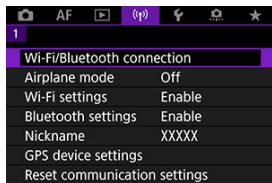

2. Select an option.

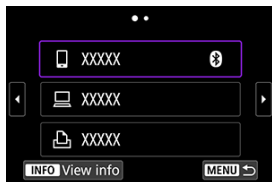

- Select an option to connect to via Wi-Fi or Bluetooth from the past connections listed. If the option is not listed, turn the < ⦿ > dial to switch screens.
- The history is not displayed when [Connection history] is set to [Hide] (☑).

3. Operate the connected device.

Smartphone

- Start Camera Connect.
- If the smartphone's connection destination has been changed, restore the setting to connect via Wi-Fi to the camera or the same access point as the camera.
When directly connecting the camera to a smartphone via Wi-Fi, “_Canon0A” is displayed at the end of the SSID.

Computer

- On the computer, start the EOS software.
- If the computer's connection destination has been changed, restore the setting to connect via Wi-Fi to the camera or the same access point as the camera.
When directly connecting the camera to a computer via Wi-Fi, “_Canon0A” is displayed at the end of the SSID.

Printer

- If the printer's connection destination has been changed, restore the setting to connect via Wi-Fi to the camera or the same access point as the camera.
When directly connecting the camera to a printer via Wi-Fi, “_Canon0A” is displayed at the end of the SSID.

Registering Multiple Connection Settings

You can register up to 10 connection settings for the wireless communication functions.

1. Select [(Wi-Fi/Bluetooth connection)].

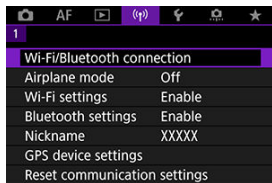

2. Select an option.

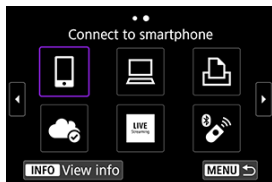

- If past connections (☑) are listed, turn the <☉> dial to switch screens.
- For details on [☑Connect to smartphone], see [Connecting to a Smartphone](#).
- For details on [☑Remote control (EOS Utility)], see [Connecting to a Computer via Wi-Fi](#).
- For details on [☑Print from Wi-Fi printer], see [Connecting to a Printer via Wi-Fi](#).
- When sending images to a Web service, see [Sending Images to a Web Service](#).

Note

- To delete connection settings, see [Changing or Deleting Connection Settings](#).

Airplane Mode

You can temporarily disable Wi-Fi and Bluetooth functions.

1. Select [**↑**]: Airplane mode].

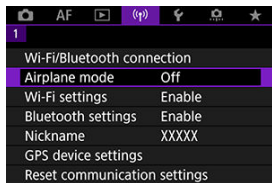

2. Set to [On].

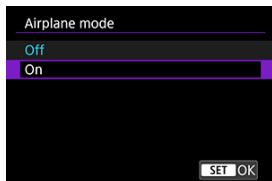

- [**↑**] is displayed on the screen.

Note

- [**↑**] may not be displayed in still photo shooting, movie recording, or playback, depending on display settings. If it is not displayed, press the <INFO> button repeatedly to access detailed information display.

Wi-Fi Settings

1. Select [(Wi-Fi): Wi-Fi settings].

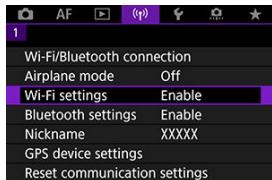

2. Select an option.

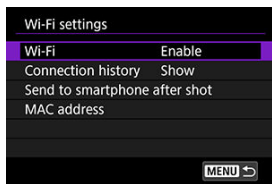

- **Wi-Fi**

When the use of electronic devices and wireless devices is prohibited, such as on board airplanes or in hospitals, set it to **[Disable]**.

- **Connection history**

You can set the connection history for devices connected via Wi-Fi to **[Show]** or **[Do not display]**.

- **Send to smartphone after shot**

Images can be transferred to a smartphone automatically (☑).

- **MAC address**

You can check the MAC address of the camera.

Bluetooth Settings

1. Select [(P): Bluetooth settings].

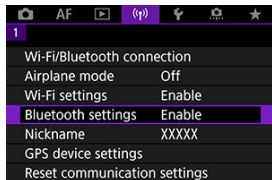

2. Select an option.

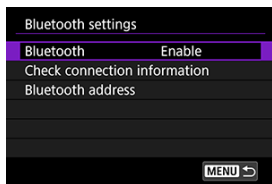

- **Bluetooth**
If you will not use the Bluetooth function, select [**Disable**].
- **Check connection information**
You can check the name and communication status of the paired device.
- **Bluetooth address**
You can check the camera's Bluetooth address.

Nickname

You can change the camera nickname (displayed on smartphones and other cameras) as needed.

1. Select [(P): Nickname].

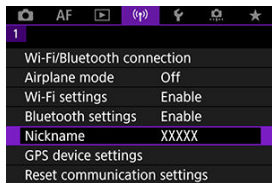

2. Enter text using the [Virtual Keyboard Operations](#).



- When you finish entering characters, press the < MENU > button.

GPS Device Settings

[GP-E2](#)

[Smartphone](#)

[GPS Connection Display](#)

You can geotag images with GPS Receiver GP-E2 (sold separately) or a Bluetooth-compatible smartphone.

GP-E2

1. Attach GP-E2 to the camera.

- Attach GP-E2* to the camera's hot shoe and turn it on. For details, refer to the GP-E2 Instruction Manual.

* Requires an optional Multi-Function Shoe Adapter AD-E1.

2. Select [(P): GPS device settings].

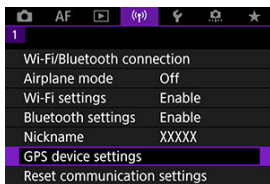

3. In [Select GPS device], select [GPS receiver].

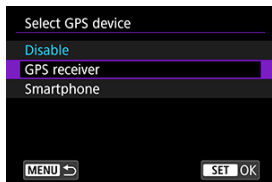

4. Take the picture.

- For details on [Set up], refer to the GP-E2 Instruction Manual.

! Caution

Precautions when using GP-E2

- Before use, check the countries and regions where use of GPS is allowed, and follow local regulations.
- Update the GP-E2 firmware to Ver. 2.0.0 or later.
Firmware updating requires an interface cable. For updating instructions, visit the Canon website.
- GP-E2 cannot be connected to the camera with a cable.
- The camera does not record the shooting direction.

Smartphone

Complete these settings after installing the dedicated Camera Connect app (📱) on the smartphone.

1. On the smartphone, activate location services.

2. Establish a Bluetooth connection.

- Start Camera Connect and pair the camera and smartphone via Bluetooth.

3. Select [(📍): GPS device settings].

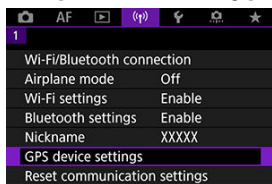

4. In [Select GPS device], select [Smartphone].

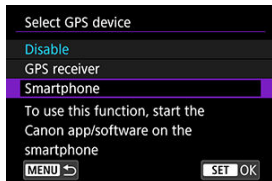

5. Take the picture.

- Images are geotagged with the information from the smartphone.

GPS Connection Display

You can check the status of smartphone location information acquisition in the GPS connection icon on the screens for still photo shooting or movie recording (📍 and 📍, respectively).

- Gray: Location services are off
- Blinking: Location information cannot be acquired
- On: Location information acquired

For details on how GPS connection status is indicated when GP-E2 is used, refer to the GP-E2 Instruction Manual.

Geotagging images as you shoot

Images you shoot while the GPS icon is on are geotagged.

Geotagging information

You can check the location information added to your shots on the shooting information screen (📍).

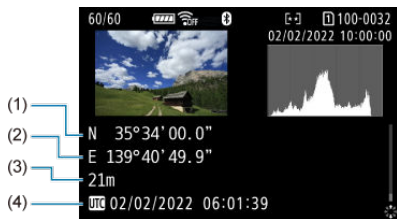

- (1) Latitude
- (2) Longitude
- (3) Elevation
- (4) UTC (Coordinated Universal Time)

 **Caution**

- The smartphone can acquire location information only while it is paired with the camera via Bluetooth.
- Direction information is not acquired.
- Acquired location information may not be accurate, depending on traveling conditions or smartphone status.
- It may take some time to acquire location information from the smartphone after you turn the camera on.
- Location information is no longer acquired after any of the following operations.
 - Pairing with a wireless remote control via Bluetooth
 - Turning the camera off
 - Quitting Camera Connect
 - Deactivating location services on the smartphone
- Location information is no longer acquired in any of the following situations.
 - The camera power turns off
 - The Bluetooth connection is ended
 - The smartphone's remaining battery level is low

 **Note**

- Coordinated Universal Time, abbreviated as UTC, is essentially the same as Greenwich Mean Time.
- For movies, the GPS information initially acquired is added.

Changing or Deleting Connection Settings

To change or delete the connection settings, terminate the Wi-Fi connection first.

1. Select [**(P)**: Wi-Fi/Bluetooth connection].

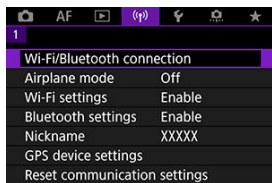

2. Select an option.

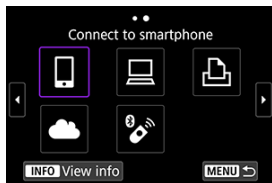

- If past connections (☑) are listed, turn the < ⦿ > dial to switch screens.

3. Select [Edit/delete device].

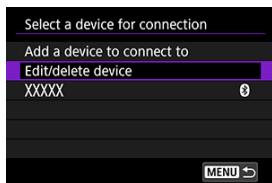

- You can change the Bluetooth connection by selecting a smartphone labeled with (P) in gray. After the [Connect to smartphone] screen is displayed, select [Pair via Bluetooth], then press the < (P) > button on the next screen.

4. Select the device for which to change or delete the connection settings.

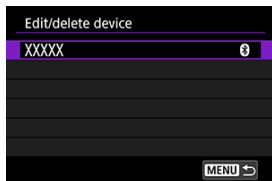

5. Select an option.

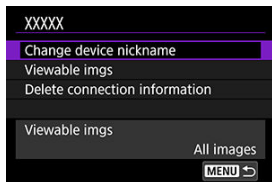

- Change or delete the connection settings on the displayed screen.
- **Change device nickname**
You can change the nickname using the virtual keyboard (🗃).
- **Viewable imgs** (🗃)
Displayed when [📱 **Connect to smartphone**] is selected. Settings will appear at the bottom of the screen.
- **Delete connection information**
When deleting connection information for a paired smartphone, also delete the camera information registered on the smartphone (🗃).

 **Note**

- To delete image.canon connection settings, visit the image.canon website.

Resetting Communication Settings

All wireless communication settings can be deleted. By deleting the wireless communication settings, you can prevent their information from being exposed when you lend or give your camera to other people.

1. Select [(Ⓜ): Reset communication settings].

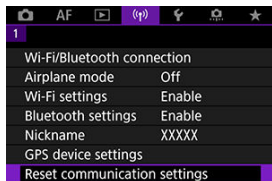

2. Select [OK].

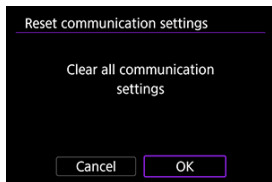

! Caution

- If you have paired the camera with a smartphone, on the smartphone's Bluetooth settings screen, delete the connection information of the camera for which you restored default wireless communication settings.

📱 Note

- All wireless communication settings can be cleared by selecting the [Communication settings] option for [Other settings] in [(Ⓜ): Reset camera].

View Info Screen

You can check error details and the camera's MAC address.

1. Select [(P): Wi-Fi/Bluetooth connection].

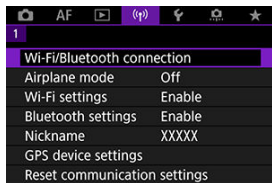

2. Press the <INFO> button.

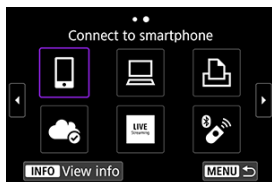

- The [View info] screen appears.

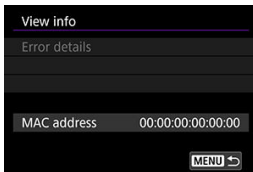



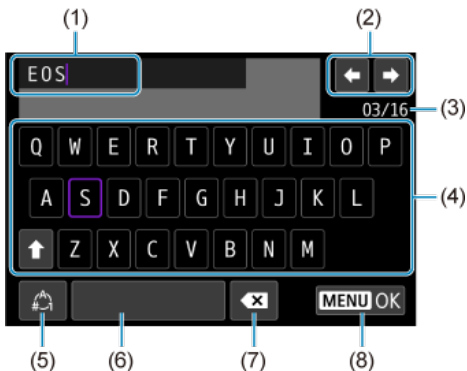

- If an error has occurred, press the < (P) > button to display error details.

Virtual Keyboard Operations



-
- (1) Input area, for entering text
-
- (2) Cursor keys, for moving in the input area
-
- (3) Current no. of characters/no. available
-
- (4) Keyboard
-
- (5) Switch input modes
-
- (6) Space
-
- (7) Delete a character in the input area
-
- (8) Exit input
-

- Use the <  > dial to move within (1).
- Use <  >, the <  > dial, or <  > to move within (2) and (4)–(7).
- Press the <  > button to confirm input or when switching input modes.

Responding to Error Messages

When an error occurs, display the details of the error by following one of the procedures below. Then, eliminate the cause of the error by referring to the examples shown in this chapter.

- On the **[View info]** screen, press the <  > button.
- Select **[Error details]** on the **[Wi-Fi on]** screen.

Click the following error numbers to jump to the corresponding section.

11	12							
21	22	23						
61	64	65						
91								
121	125	127						
130	131	133	134	135	136	137	138	
141	142							



Note

- When an error occurs, **[Err**]** is displayed in the upper right of the **[Wi-Fi/Bluetooth connection]** screen. It disappears when the camera's power is set to **<OFF>**.

11: Connection target not found

- **In the case of [📷], is Camera Connect running?**
 - Establish a connection using Camera Connect (🔗).
- **In the case of [📺], is EOS Utility running?**
 - Start EOS Utility and try to connect again (🔗).
- **Are the camera and the access point set to use the same encryption key for authentication?**
 - This error occurs if the encryption keys do not match when the authentication method for encryption is **[Open system]**.
Check upper- and lower-case letters, and make sure the correct encryption key for authentication is set on the camera (🔗).

12: Connection target not found

- **Are the target device and access point turned on?**
 - Turn on the target device and access point, then wait a while. If a connection still cannot be established, perform the procedures to establish the connection again.

21: No address assigned by DHCP server

What to check on the camera

- **On the camera, the IP address is set to [Auto setting]. Is this the correct setting?**
 - If no DHCP server is used, configure the setting after setting the IP address to **[Manual setting]** on the camera (🔗).

What to check on the DHCP server

- **Is the power of the DHCP server on?**
 - Turn on the DHCP server.
- **Are there enough addresses for assignment by the DHCP server?**
 - Increase the number of addresses assigned by the DHCP server.
 - Remove devices assigned addresses by the DHCP server from the network to reduce the number of addresses in use.
- **Is the DHCP server working correctly?**
 - Check the DHCP server settings to make sure it is working correctly as a DHCP server.
 - If applicable, ask your network administrator to ensure the DHCP server is available.

What to check on the DNS server

- **Is the power of the DNS server on?**
 - Turn the DNS server on.
- **Are the DNS server settings for IP addresses and the corresponding names correct?**
 - On the DNS server, make sure IP addresses and the corresponding names are entered correctly.
- **Is the DNS server working correctly?**
 - Check the DNS server settings to make sure the server is working correctly as a DNS server.
 - If applicable, ask your network administrator to ensure the DNS server is available.

What to check on the network as a whole

- **Does your network include a router or similar device that serves as a gateway?**
 - If applicable, ask your network administrator for the network gateway address and set it on the camera (☞, ☞).
 - Make sure that the gateway address setting is correctly entered on all network devices including the camera.

23: Device with same IP address exists on selected network

- **Is another device on the camera network using the same IP address as the camera?**
 - Change the camera's IP address to avoid using the same address as another device on the network. Otherwise, change the IP address of the device that has a duplicate address.
 - If the camera's IP address is set to **[Manual setting]** in network environments using a DHCP server, change the setting to **[Auto setting]** (🔗).

Note

Responding to error messages 21–23

- Also check the following points when responding to errors numbered 21–23.
Are the camera and the access point set to use the same password for authentication?
 - This error occurs if the passwords do not match when the authentication method for encryption is set to **[Open system]**. Check upper- and lower-case letters, and make sure the correct password for authentication is set on the camera (🔗).

61: Selected SSID wireless LAN network not found

- **Are any obstacles blocking the line of sight between the camera and the antenna of the access point?**
 - Move the antenna of the access point to a position clearly visible from the point of view of the camera.

What to check on the camera

- **Does the SSID set on the camera match that of the access point?**
 - Check the SSID at the access point, then set the same SSID on the camera (🔗).

What to check at the access point

- **Is the access point turned on?**
 - Turn on the power of the access point.
- **If filtering by MAC address is active, is the MAC address of the camera in use registered at the access point?**
 - Register the MAC address of the camera used to the access point (🔗).

64: Cannot connect to wireless LAN terminal

- **Are the camera and the access point set to use the same encryption method?**
 - The camera supports the following encryption methods: WEP, TKIP, and AES (🔒).
- **If filtering by MAC address is active, is the MAC address of the camera in use registered at the access point?**
 - Register the MAC address of the camera used to the access point. The MAC address can be checked on the [MAC address] screen (🔒).

65: Wireless LAN connection lost

- **Are any obstacles blocking the line of sight between the camera and the antenna of the access point?**
 - Move the antenna of the access point to a position clearly visible from the point of view of the camera.
- **The wireless LAN connection was lost, for some reason, and the connection cannot be restored.**
 - The following are possible reasons: excessive access to the access point from another device, a microwave oven or similar appliance in use nearby (interfering with IEEE 802.11b/g/n (2.4 GHz band)), or influence of rain or high humidity.

91: Other error

- **A problem other than error code number 11 to 83 occurred.**
 - Turn the camera's power switch off and on.

121: Not enough free space on server

- **The target Web server does not have enough free space.**
 - Delete unnecessary images on the Web server, check the free space on the Web server, then try sending the data again.

125: Check the network settings

- **Is the network connected?**
 - Check the connection status of the network.

127: An error has occurred

- **A problem other than error code number 121 to 126 occurred while the camera is connected to the Web service.**
 - Try again to establish the Wi-Fi connection to image.canon.

**130: The server is currently busy
Please wait a moment and try again**

- **The image.canon site is busy at the moment.**
 - Try accessing image.canon over Wi-Fi again later.

131: Try again

- **An error occurred when connecting to image.canon over Wi-Fi.**
 - Try again to establish the Wi-Fi connection to image.canon.

133: Cannot log in to Web service

- **An error occurred when signing in to image.canon.**
 - Check the image.canon settings.
 - Try accessing image.canon over Wi-Fi again later.

134: Set the correct date and time

- **The date, time, and time zone settings are incorrect.**
 - Check the [: Date/Time/Zone] settings.

135: Web service settings have been changed

- **The settings for image.canon were changed.**
 - Check the image.canon settings.

**136: The QR code shown on the camera was not scanned correctly
by the dedicated app. Try camera web link setup again.**

- **The QR code was not scanned correctly by the smartphone.**
 - Reconfigure camera web link settings and scan the QR code displayed again on the camera.

**137: The QR code shown on the camera has expired. Try camera web
link setup again.**

- **The QR code displayed has expired.**
 - Reconfigure camera web link settings and scan the QR code displayed again on the camera.

138: Communication error with server. Please send again.

- **Could not connect to the server for some reason.**
 - Check the status of cloud RAW image processing online at image.canon and try uploading the images again.

141: Printer is busy. Try connecting again.

- **Is the printer performing a printing process?**
 - Try again to establish the Wi-Fi connection to the printer after the printing process is finished.
- **Is another camera connected to the printer via Wi-Fi?**
 - Try again to establish the Wi-Fi connection to the printer after the Wi-Fi connection to the other camera has been terminated.

142: Could not acquire printer information. Reconnect to try again.

- **Is the power of the printer on?**
 - Try again to establish the Wi-Fi connection after turning on the printer.

Wireless Communication Function Precautions

- [Distance between the camera and the smartphone](#)
- [Installation location of access point antenna](#)
- [Nearby electronic devices](#)
- [Precautions for using multiple cameras](#)

If the transmission rate drops, the connection is lost, or other problems occur when using the wireless communication functions, try the following corrective actions.

Distance between the camera and the smartphone

If the camera is too far from the smartphone, a Wi-Fi connection may not be established even when Bluetooth connection is possible. In this case, bring the camera and the smartphone closer together, then establish a Wi-Fi connection.

Installation location of access point antenna

- When using indoors, install the device in the room where you are using the camera.
- Install the device where people or objects do not come between the device and the camera.

Nearby electronic devices

If the Wi-Fi transmission rate drops because of the influence of the following electronic devices, stop using them or move further away from the devices to transmit communication.

- The camera communicates over Wi-Fi via IEEE 802.11b/g/n using radio waves in the 2.4 GHz band. For this reason, the Wi-Fi transmission rate will drop if there are Bluetooth devices, microwave ovens, cordless telephones, microphones, smartphones, other cameras, or similar devices operating on the same frequency band nearby.

Precautions for using multiple cameras

- When connecting multiple cameras to one access point via Wi-Fi, make sure the cameras' IP addresses are different.
- When multiple cameras are connected to one access point via Wi-Fi, the transmission rate drops.
- When there are multiple IEEE 802.11b/g/n (2.4 GHz band) access points, leave a gap of five channels between each Wi-Fi channel to reduce radio wave interference. For example, use channels 1, 6, and 11, channels 2 and 7, or channels 3 and 8.

Security

If security settings have not been properly set, the following problems may occur.

- **Transmission monitoring**
Third parties with malicious intent may monitor wireless LAN transmissions and attempt to acquire the data you are sending.
- **Unauthorized network access**
Third parties with malicious intent may gain unauthorized access to the network you are using to steal, modify, or destroy information. Additionally, you could fall victim to other types of unauthorized access such as impersonation (where someone assumes an identity to gain access to unauthorized information) or springboard attacks (where someone gains unauthorized access to your network as a springboard to cover their tracks when infiltrating other systems).

It is recommended to make use of the systems and functions to thoroughly secure your network, preventing these types of problems from occurring.

Checking Network Settings

Windows

Open the Windows **[Command Prompt]**, then enter `ipconfig/all` and press the <Enter> key. In addition to the IP address assigned to the computer, the subnet mask, gateway, and DNS server information are also displayed.

macOS

In macOS, open the **[Terminal]** application, enter `ifconfig -a`, and press the <Return> key. The IP address assigned to the computer is indicated in the **[enX]** item (X: number) next to **[inet]**, in the format `****.***.***.***`.

For information about the **[Terminal]** application, refer to the macOS help.

To avoid using the same IP address for the computer and other devices on the network, change the rightmost number when configuring the IP address assigned to the camera in the processes described in [Manual IP Address Setup](#).

Example: 192.168.1.**10**

Wireless Communication Status

Wireless communication status can be checked on the screen.



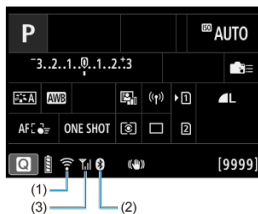







Quick Control screen





Information display screen during playback



- (1) Wi-Fi function
- (2) Bluetooth function
- (3) Wireless signal strength

Communication Status		Screen	
		Wi-Fi Function	Wireless Signal Strength
Not connected	Wi-Fi: Disable		Off
	Wi-Fi: Enable		
Connecting			
Connected			
Sending data			
Connection error			

Bluetooth Function Indicator

Bluetooth Function	Connection Status	Screen
Other than [Disable]	Bluetooth connected	
	Bluetooth not connected	
[Disable]	Bluetooth not connected	Not displayed

Set-up

This chapter describes menu settings on the set-up [🔧] tab.

☆ to the right of titles indicates functions only available in < **Fv** >, < **P** >, < **Tv** >, < **Av** >, < **M** >, or < **B** > mode.

- [Tab Menus: Set-up](#)
- [Selecting Cards for Recording/Playback](#)
- [Folder Settings](#)
- [File Numbering](#)
- [File Naming](#)
- [Card Formatting](#)
- [Auto Rotate](#)
- [Adding Orientation Information to Movies](#)
- [Date/Time/Zone](#)
- [Language](#)
- [Video System](#)
- [Help](#)
- [Shooting Mode Guide](#)
- [Beeps](#)
- [Volume](#)
- [Headphones](#)
- [Power Saving](#)
- [Screen and Viewfinder Display](#)
- [Screen Brightness](#)
- [Viewfinder Brightness](#)
- [Screen and Viewfinder Color Tone](#)
- [Fine-Tuning Viewfinder Color Tone](#)
- [UI Magnification](#)
- [HDMI Resolution](#)
- [Touch Control](#)
- [Multi-Function Lock](#)
- [Focus Mode Switch \(AF/MF\)](#)
- [Shutter at Shutdown](#)
- [Sensor Cleaning](#)
- [App Selection for USB Connections](#)
- [Resetting the Camera](#) ☆
- [Custom Shooting Mode \(C1–C3\)](#) ☆
- [Battery Information](#)

- [Copyright Information](#) ☆
- [Other Information](#)

Tab Menus: Set-up

● Set-up 1

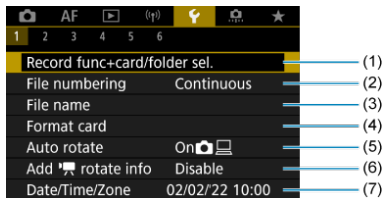

- (1) Record func+card/folder sel.
- [Selecting Cards for Recording/Playback](#)
 - [Creating a Folder](#)
- (2) [File numbering](#)
- (3) [File name](#)
- (4) [Format card](#)
- (5) [Auto rotate](#)
- (6) [Add rotate info](#)
- (7) [Date/Time/Zone](#)

● Set-up 2

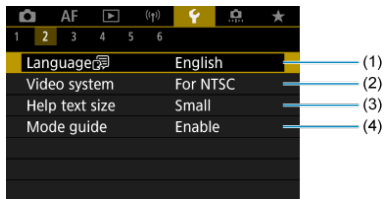

- (1) [Language](#)
- (2) [Video system](#)
- (3) [Help text size](#)
- (4) [Mode guide](#)

● Set-up 3

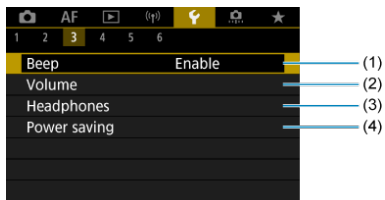

- (1) [Beep](#)
- (2) [Volume](#)
- (3) [Headphones](#)
- (4) [Power saving](#)

● Set-up 4

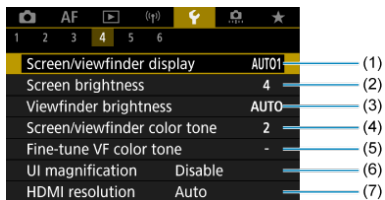

- (1) [Screen/viewfinder display](#)
- (2) [Screen brightness](#)
- (3) [Viewfinder brightness](#)
- (4) [Screen/viewfinder color tone](#)
- (5) [Fine-tune VF color tone](#)
- (6) [UI magnification](#)
- (7) [HDMI resolution](#)

● Set-up 5

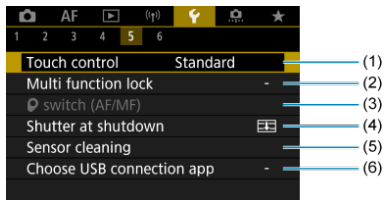

- (1) [Touch control](#)
- (2) [Multi function lock](#)
- (3) [switch \(AF/MF\)](#)
- (4) [Shutter at shutdown](#)
- (5) [Sensor cleaning](#)
- (6) [Choose USB connection app](#)

● Set-up 6



- (1) [Reset camera](#) ☆
- (2) [Custom shooting mode \(C1-C3\)](#) ☆
- (3) [Battery info.](#)
- (4) [Copyright information](#) ☆
- (5) [Manual/software URL](#)
- (6) [Certification Logo Display](#) ☆
- (7) [Firmware](#)

Selecting Cards for Recording/Playback

[Recording Method with Two Cards Inserted](#)

[Recording/Playback Selection with Two Cards Inserted](#)

Recording is possible when card [1] or [2] is in the camera (except under some conditions). With only one card inserted, there is no need to follow these steps.

With two cards inserted, you can select the recording method and card to use for recording and playback as follows.

Recording Method with Two Cards Inserted

1. Select [: Record func+card/folder sel.].

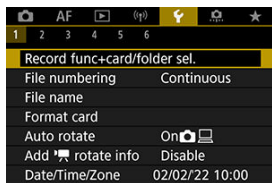



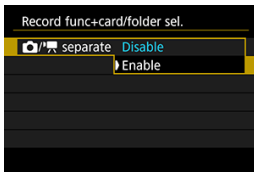

2. Set the recording method.

● separate





- Select **[Enable]** for automatic configuration of the recording method for still photos and movies. Still photos are recorded to card [1] and movies to card [2].
- Without card [1] inserted, still photos can be captured but not saved. Still photo shooting is not possible if the card is full.
- Movie recording is not possible if card [2] is full or not inserted.

Caution

- Specifying **[Enable]** will make [ **Rec options**], [ **Rec options**], [ **Record/play**], and [ **Record/play**] unavailable.

Note

- When set to **[Enable]**, card [2] is used for playback if the <  > button is pressed in movie recording mode. Card [1] is used for playback if the <  > button is pressed in still photo shooting mode.
- When **[Enable]** is set, consider setting [ **Release shutter without card**] to **[Disable]**.

● Rec options

Set the recording method for still photos.

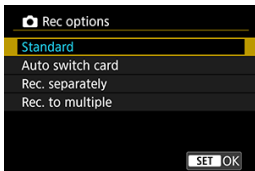



- **Standard**

Records still photos to the card selected in [ Record/play].

- **Auto switch card**



Same as [**Standard**], but additionally, the camera switches to the other card when one card becomes full. At this time, a new folder is created.

- **Rec. separately**



Enables you to set a specific image size for each card (). For each shot, a still photo is recorded to card  and  in your specified image quality.

Note that recording separately to **RAW** and **CRAW** is not available for RAW images.

- **Rec. to multiple**

For each shot, a still photo is recorded to card  and  in the same image quality.

Caution

- Maximum burst for [**Rec. separately**] is lower if you specify different image sizes for cards  and  (.

Note

Rec. separately/Rec. to multiple

- Images are recorded with the same file number to card [1] and [2].
- The number of shots available as shown in the viewfinder and on the Quick Control screen is for the card with less free space.
- [Card* full] is displayed when one of the cards becomes full, and shooting is no longer possible. To continue shooting, either replace the card or set [Rec options] to [Standard] and select the card with free space.
- See [Folder Settings](#) for details on [Folder] in [F: Record func +card/folder sel.].

Rec options

Set the recording method for movies.

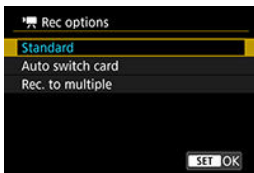

Standard

Records movies to the card selected in [Record/play].

Auto switch card





Same as [Standard], but recording ends when the card becomes full. When you resume recording, the camera switches to the other card for recording. A new folder is created after switching cards.

Rec. to multiple

For each recording, the same movie is recorded to card [1] and [2].

 **Note**

Rec. to multiple

- Images are recorded with the same file number to card  and .
- The available recording time shown in the viewfinder and on the Quick Control screen is for the card with less free space.
- **[Card* full]** is displayed when one of the cards becomes full, and shooting is no longer possible. To continue shooting, either replace the card or set [ **Rec options**] to **[Standard]** and select the card with free space.
- See [Folder Settings](#) for details on **[Folder]** in [: **Record func +card/folder sel.**].

Recording/Playback Selection with Two Cards Inserted

With [📷 Rec options]/[🎥 Rec options] set to [Standard] or [Auto switch card], select the card for recording and playback.

With [📷 Rec options] set to [Rec. separately] or [Rec. to multiple], or with [🎥 Rec options] set to [Rec. to multiple], select the card for playback.

Setting via the menu

● Standard/Auto switch card

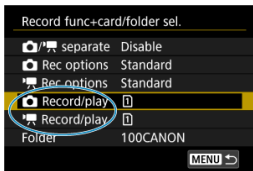

Select [Record/play].

- Select [📷 Record/play] for still photos or [🎥 Record/play] for movies.
 - ①: Use card 1 for recording and playback
 - ②: Use card 2 for recording and playback

● Rec. separately/Rec. to multiple

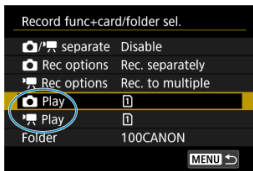

Select [Play].

- Select [📷 Play] for still photos or [🎥 Play] for movies.
- Pressing the <▶> button in still photo shooting mode plays images from the card selected in [📷 Play].
- Pressing the <▶> button in movie recording mode plays images from the card selected in [🎥 Play].



Note

- With [**Priority:** 1] set, the camera switches to the priority card when cards are inserted or removed.

Folder Settings

- [Creating a Folder](#)
- [Renaming Folders](#)
- [Selecting a Folder](#)

You can freely create and select the folder where the captured images are to be saved. You can also rename folders.

Creating a Folder

1. Select [: Record func+card/folder sel.].

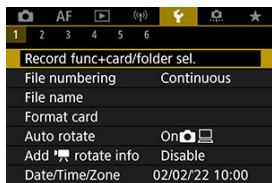

2. Select [Folder].

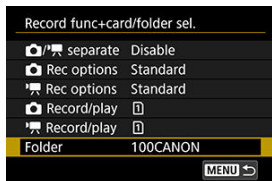

3. Select [Create folder].

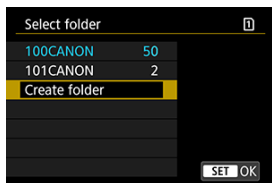

4. Select [OK].

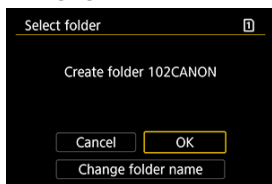

- To rename the folder, select [Change folder name].

1. Enter letters and numbers of your choice.

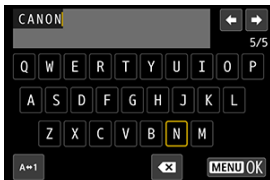

- You can enter five characters.
- By selecting [**A↔1**], you can change the input mode.
- To delete single characters, select [**X**] or press the > button.



- Use the > dial or > to select a character, then press the > button to enter it.

2. Exit the setting.

- Press the < **MENU** > button, then press [**OK**].

Selecting a Folder

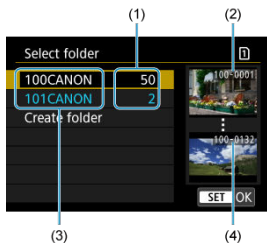

- (1) Number of images in folder
- (2) Lowest file number
- (3) Folder name
- (4) Highest file number

- Select a folder on the folder selection screen.
- Captured images are stored in your selected folder.

Note

Folders

- Folders are named as in "100CANON," with a three-digit folder number followed by five letters or numbers. A folder can contain up to 9999 images (file number 0001–9999). When a folder becomes full, a new folder with the folder number increased by one is created automatically. Also, if manual reset (Ⓢ) is executed, a new folder will be created automatically. Folders numbered from 100 to 999 can be created.

Creating folders with a computer

- With the card open on the screen, create a new folder with "DCIM" as the name. Open the DCIM folder and create as many folders as necessary to save and organize your images. "100ABC_D" is the required format for folder names, and the first three digits must be a folder number in the range 100–999. The last five characters can be any combination of upper- and lower-case letters from A to Z, numerals, and the underscore "_". The space cannot be used. Also note that two folder names cannot share the same three-digit folder number (for example, "100ABC_D" and "100W_XYZ") even if the remaining five characters in each name are different.

File Numbering

- [Continuous](#)
- [Auto Reset](#)
- [Manual Reset](#)

The captured images saved in a folder are assigned a file number from 0001 to 9999. You can change how the image files are numbered.

(Example)
IMG_0001.JPG
|
(1)
(1) File number

1. Select [: File numbering].

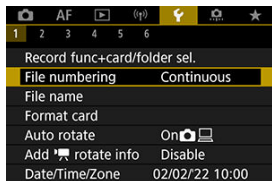

2. Set the item.

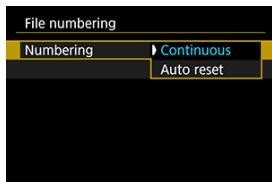

- Select [**Numbering**].
- Select [**Continuous**] or [**Auto reset**].

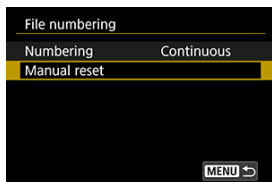

- If you want to reset the file numbering, select [**Manual reset**] (🔗).

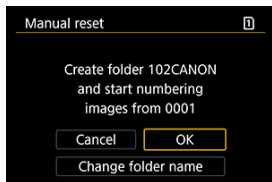

- Select [**OK**] to create a new folder, and the file number will start with 0001.

⚠ Caution

- If the file number in folder 999 reaches 9999, shooting will not be possible even if the card still has free space. After a message requesting you to replace the card is displayed, switch to a new card.

For continuous file numbering regardless of switching cards or creating folders

File numbering is continuous up to 9999, even if you replace a card, create a folder, or switch the target card (as in ①→②). This is useful when you want to save images numbered anywhere between 0001 to 9999 on multiple cards or in multiple folders into one folder on a computer.

Note that file numbering may continue from any existing images in cards or folders that you switch to. If you want to use continuous file numbering, it is recommended that you use a newly formatted card each time.

File numbering after replacing cards or switching target cards

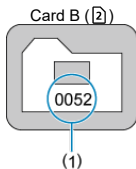
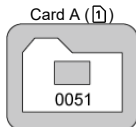

(1) Next sequential file number

File numbering after creating a folder

Card A

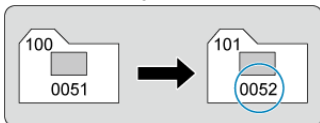

For restarting file numbering from 0001 after switching cards or creating folders

File numbering is reset to 0001 if you replace a card, create a folder, or switch the target card (as in ①→②). This is useful if you want to organize images by cards or folders. Note that file numbering may continue from any existing images in cards or folders that you switch to. If you want to save images with the file numbering starting from 0001, use a newly formatted card each time.

File numbering after replacing cards or switching target cards

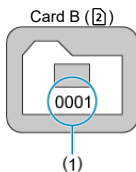
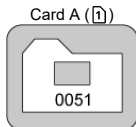

(1) File numbering is reset

File numbering after creating a folder

Card A

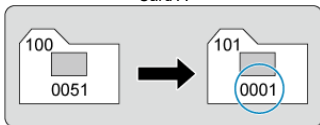

For resetting file numbering to 0001 or starting from 0001 in new folders

When you reset the file numbering manually, a new folder is created automatically and the file numbering of images saved to that folder starts from 0001.

This is useful, for example, if you want to use different folders for the images taken yesterday and the ones taken today.

File Naming

[Registering/Changing File Names](#)

File names consist of four alphanumeric characters followed by a four-digit file number (🔗) and file extension. You can change the first four alphanumeric characters, which by default are unique for each camera and set when the camera is shipped.

User setting 1 enables you to register four characters of your choice. User setting 2 adds three initial, registered characters of your choice to a fourth character representing the image size that is added automatically after you shoot.

(Example)
IMG_0001.JPG

Registering/Changing File Names

1. Select [: File name].

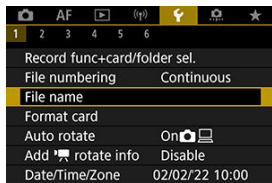

2. Select [Change User setting*].

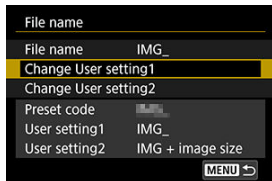

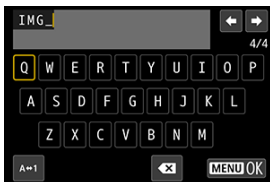

3. Enter letters and numbers of your choice.



- Enter four characters for User setting 1 or three for User setting 2.
- By selecting [**A⇌1**], you can change the input mode.
- To delete single characters, select [**X**] or press the  button.



- Use the  dial or  to select a character, then press the  button to enter it.

4. Exit the setting.

- Press the **<MENU>** button, then press **[OK]**.

5. Select a registered file name.

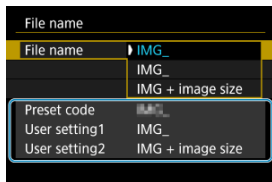

- Select [**File name**], then choose a registered file name.

⚠ Caution

- An underscore (“_”) cannot be used as the first character.

📄 Note

User setting 2

- Shooting after you have selected “**** + image size” (as registered to User setting 2) will add a character representing the current image size to your file name as the fourth character. Meanings of added characters are as follows.

“***L”: L, L, RAW, or HEIF

“***M”: M or M

“***S”: S1 or S1

“***T”: S2

“***C”: CRAW

The automatically added fourth character enables you to determine image sizes without opening the files after transferring them to a computer. Based on file extensions, you can also distinguish RAW, JPEG, and HEIF images.

- Movies recorded with User setting 2 are named with the fourth character as an underscore.

Card Formatting

If the card is new or was previously formatted (initialized) by another camera or computer, format the card with this camera.

Caution

- When the card is formatted, all images and data on the card will be erased. Even protected images will be erased, so make sure there is nothing you need to keep. If necessary, transfer the images and data to a computer, etc. before formatting the card.

1. Select [🔧: Format card].

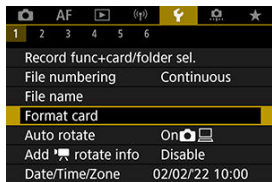

2. Select a card.

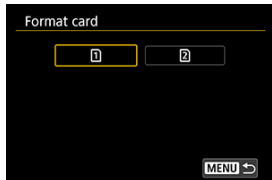

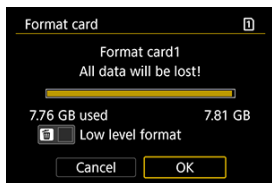

- [1] represents card 1, and [2], card 2.
- Select the card.

3. Format the card.

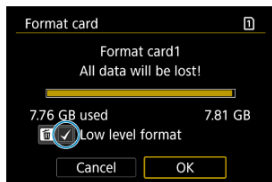

- Select **[OK]**.



- For low-level formatting, press the  button to add a checkmark [✓] to **[Low level format]**, then select **[OK]**.

Conditions requiring card formatting

- The card is new.
- The card was formatted by a different camera or a computer.
- The card is full of images or data.
- A card-related error is displayed ()

Low-level formatting

- Perform low-level formatting if the card's writing or reading speed seems slow or if you want to totally erase the data on the card.
- Since low-level formatting will format all recordable sectors on the card, the formatting will take longer than normal formatting.
- During low-level formatting, you can cancel formatting by selecting [**Cancel**]. Even in this case, normal formatting will already be complete and you can use the card as usual.

Card file formats

- SD cards will be formatted in FAT12 or FAT16, SDHC cards in FAT32, and SDXC cards in exFAT.
- Individual movies recorded to exFAT-formatted cards are recorded as a single file (without splitting them into multiple files) even if they exceed 4 GB, so the resulting movie file will exceed 4 GB.

Caution

- It may not be possible to use SDXC cards formatted with this camera in other cameras. Also note that exFAT-formatted cards may not be recognized by some computer operating systems or card readers.
- Formatting or erasing data on a card does not completely erase the data. Be aware of this when selling or discarding the card. When disposing of cards, take steps to protect personal information if necessary, as by physically destroying cards.

Note

- The card capacity displayed on the card format screen may be smaller than the capacity indicated on the card.
- This device incorporates exFAT technology licensed from Microsoft.

Auto Rotate

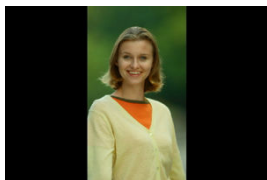

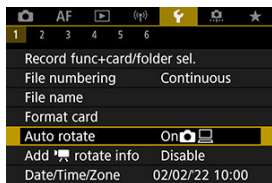

You can change the auto rotation setting that straightens images shot in vertical orientation when they are displayed.

1. Select [: Auto rotate].

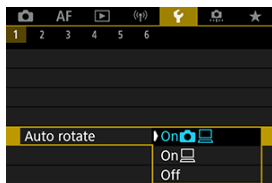

2. Select an option.



- **On** 
Automatically rotates images for display on both the camera and computers.
- **On** 
Automatically rotates images only for display on computers.
- **Off**
Images are not automatically rotated.

Caution

- Images captured with auto rotation set to **[Off]** will not rotate during playback even if you later set auto rotation to **[On]**.

Note

- If a picture is taken while the camera is aimed up or down, automatic rotation to the proper orientation for viewing may not be performed correctly.
- If images are not rotated automatically on a computer, try using EOS software.

Adding Orientation Information to Movies

For movies recorded with the camera held vertically, orientation information indicating which side is up can be added automatically to enable playback in the same orientation on smartphones or other devices.

1. Select [: Add  rotate info].

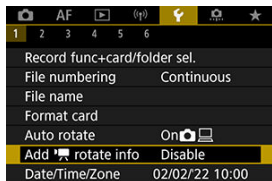

2. Select an option.

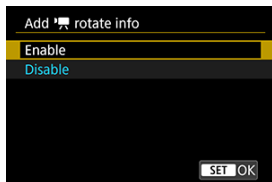

- **Enable**
Play movies on smartphones or other devices in the orientation in which they were recorded.
- **Disable**
Play movies horizontally on smartphones or other devices, regardless of the recording orientation.

Caution

- Movies are played horizontally on the camera and via HDMI video output, regardless of this setting.

Date/Time/Zone

When you turn on the power for the first time or if the date/time/zone have been reset, follow these steps to set the time zone first.

By setting the time zone first, you can simply adjust this setting as needed in the future and the date/time will be updated to match it.

Since the captured images will be appended with the shooting date and time information, be sure to set your date/time.

1. Select [: Date/Time/Zone].

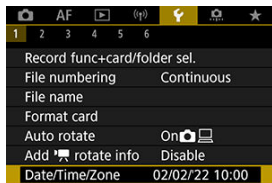

2. Set the time zone.

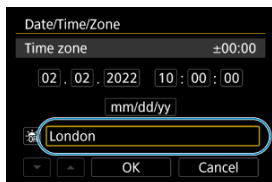

- Turn the <  > dial to select [Time zone].

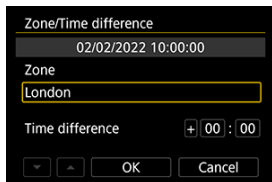

- Press the <  > button.

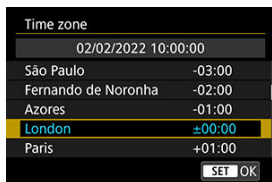

- Select the time zone.
- If your time zone is not listed, press the <MENU> button, then set the difference from UTC in [Time difference].

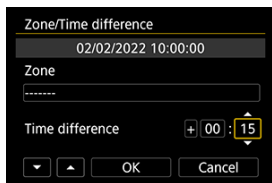

- Select a [Time difference] option (+-/hour/minute), then press the <SET> button.
- After setting the item, press the <MENU> button.
- After entering the time zone or time difference, select [OK].

3. Set the date and time.

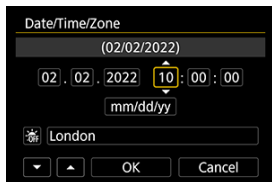

- Select an item, then press the <MENU> button.
- After setting the item, press the <SET> button.

4. Set daylight saving time.

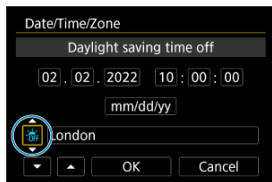

- Set it as necessary.
- Select [☀️] or [🌑], then press the <⏪> button.
- When the daylight saving time is set to [🌑], the time set in step 3 will advance by 1 hour. If [☀️] is set, the daylight saving time will be canceled and the time will go back by 1 hour.

5. Exit the setting.

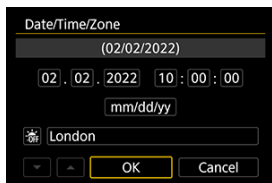

- Select [OK].

⚠️ Caution

- The date, time, and time zone settings may be reset when the camera is stored without the battery, when the battery is exhausted, or when it is exposed to freezing temperatures for an extended period. If this happens, set them once again.
- After changing [Zone/Time difference], check that the correct date/time are set.

📄 Note

- Auto power off time may be extended while the [🔌: Date/Time/Zone] screen is displayed.

Language

1. Select [: Language ].

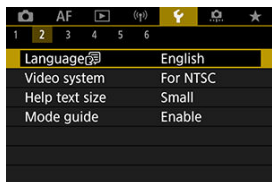

2. Set the desired language.



Video System

Set the video system of any television used for display. This setting determines the frame rates available when you record movies.

1. Select [Video system].

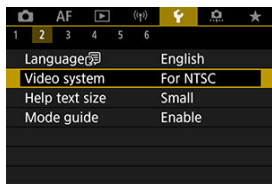

2. Select an option.

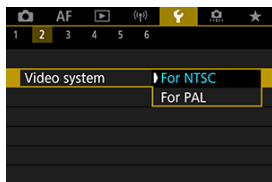

- **For NTSC**
For areas where the TV system is NTSC (North America, Japan, South Korea, Mexico, etc.).
- **For PAL**
For areas where the TV system is PAL (Europe, Russia, China, Australia, etc.).

Help

[Changing the Help Text Size](#)

When [**INFO Help**] is displayed, you can display a description of the feature by pressing the < **INFO** > button. Press it again to exit Help display. To scroll the screen when a scrollbar (1) appears on the right, turn the <  > dial.

● Example: []: Bracketing auto cancel]

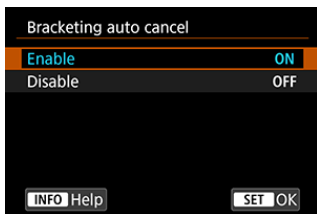

< **INFO** >

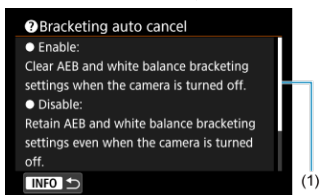

- Example: [Y]: Multi function lock

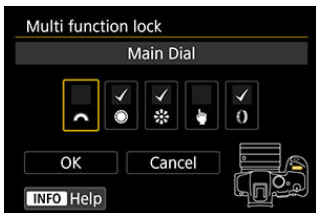

<INFO>

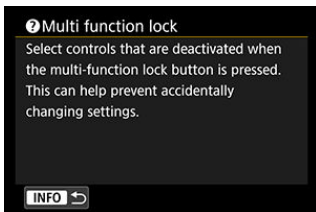

Changing the Help Text Size

1. Select [**F**: Help text size].

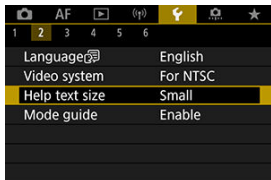

2. Select an option.

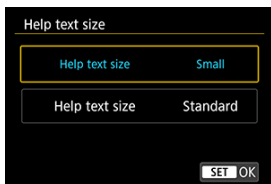

Shooting Mode Guide

A brief description of the shooting mode can be displayed when you switch shooting modes. The default setting is [Enable].

1. Select [: Mode guide].

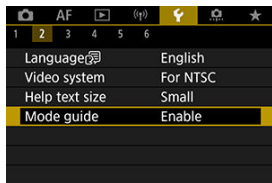

2. Select [Enable].

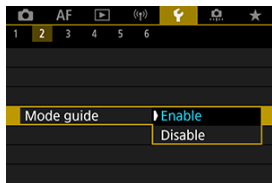

3. Turn the Mode dial.

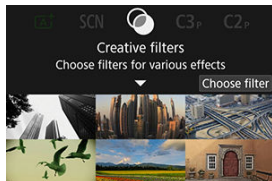

- A description of the selected shooting mode will appear.

4. Press the < ▼ > key.

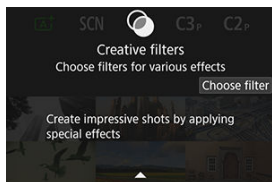

- The rest of the description will appear.
- To clear the mode guide, press the < (Ⓜ) > button.
- In < **SCN** >/< (Ⓜ) > mode, you can display the shooting mode selection screen.

Beeps

1. Select [: Beep].

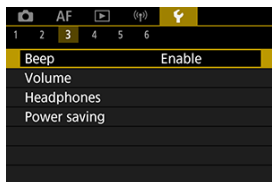

2. Select an option.

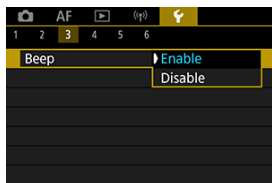

- **Enable**
The camera beeps after focusing and in response to touch operations.
- **Disable**
Disables beeping for focusing, self-timer, shutter, and touch operations.

Note

- By default, beeping volume for touch operations is set to **[0]** ()

Volume

The volume of camera sounds is adjustable.

1. Select [: Volume].

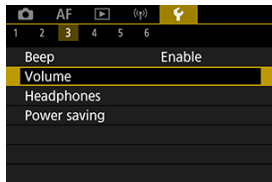

2. Set the option.

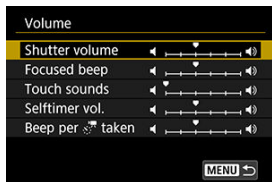

- Select an option, then turn the <  > dial to adjust the volume.

Headphones

[Volume](#)

[Audio Monitoring](#)

Volume

1. Select [**Headphones**].

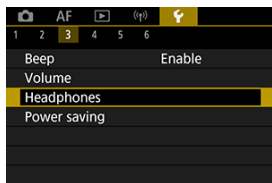

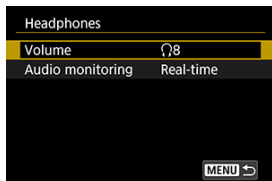

2. Select [**Volume**].

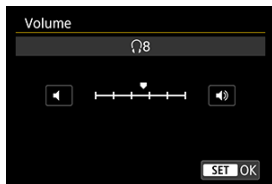

3. Adjust the volume.



- Turn the <  > dial to adjust the volume, then press the <  > button.

Note

- You can check sound from the built-in microphone or an external microphone on headphones when [: **Sound recording**] is set to an option other than [**Disable**] and [**High Frame Rate**] is set to [**Off**].

Audio Monitoring

You can choose the audio during movie recording that is used for headphone output. To reduce noise in audio recording, configure **[Audio noise reduc.]** (🔗).

1. Select **[Audio monitoring]**.

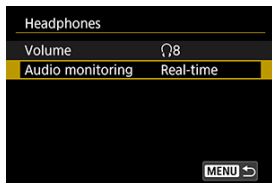

2. Select an option.

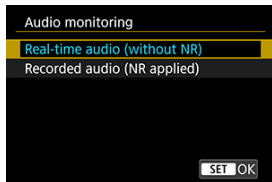

- **Real-time audio (without NR)**
Audio output without noise reduction.
- **Recorded audio (NR applied)**
Audio output with noise reduction.

⚠ Caution

- Selecting **[Recorded audio (NR applied)]** results in audio output that is slightly out of sync with video. Audio in recorded movies is not delayed.

Power Saving

You can adjust the timing of when the screen dims and then turns off, when the camera turns off, and when the viewfinder turns off after the camera is left idle (Screen dimmer, Screen off, Auto power off, and Viewfinder off).

1. Select [: Power saving].

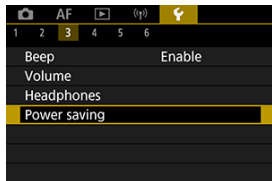

2. Select an option.

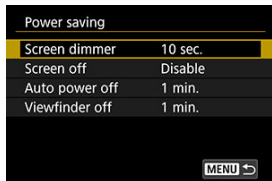

 **Note**

- **[Screen dimmer]** and **[Screen off]** apply while the shooting screen is displayed. These settings do not apply during menu display or image playback.
- The camera turns off during menu display or image playback after the time set in **[Screen dimmer]**, **[Screen off]**, and **[Auto power off]** elapses.
- To protect the screen, the screen turns off 30 min. after it is dimmed (although the camera itself remains on), even if **[Screen off]** and **[Auto power off]** are set to **[Disable]**.
- **[Viewfinder off]** also applies while the screen is still on. After this time elapses, the viewfinder sensor is deactivated.
- Only **[Viewfinder off]** applies during viewfinder display. After this time elapses, the viewfinder sensor is deactivated and the viewfinder turns off.
- Images on the screen are displayed at a lower frame rate after the screen dims during still photo shooting standby.

Screen and Viewfinder Display

You can specify to use the screen or viewfinder for display, to avoid accidentally activating the viewfinder sensor when the screen is open.

1. Select [📷: Screen/viewfinder display].

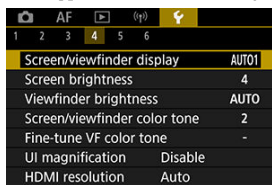

2. Select an option.

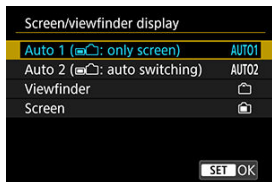

- **AUTO1: Auto 1 (📷📺): only screen)**
Always use the screen for display when it is open.
Use the screen for display when it is closed and facing you, and switch to the viewfinder when you look through it.
- **AUTO2: Auto 2 (📷📺): auto switching)**
Use the screen for display when it is closed and facing you, and switch to viewfinder display when you look through the viewfinder.
- **📺: Viewfinder**
Always use the viewfinder for display.
- **📺: Screen**
Always use the screen for display when it is open.



Note

- You can also switch between viewfinder and screen display by pressing a button you have customized by assigning to switching. With this setting set to **[AUTO1]** or **[AUTO2]**, the camera responds to the viewfinder sensor accordingly.
- With **[AUTO1]** set, the camera does not respond to the viewfinder sensor when the screen is open.

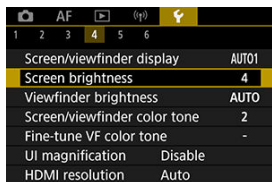

Screen Brightness

1. Select [: Screen brightness].

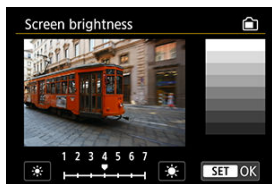

2. Make the adjustment.



- Referring to the gray image, turn the < > dial to adjust brightness, then press the < > button. Check the effect on the screen.

Note

- To check the image's exposure, referring to the histogram is recommended ().

Viewfinder Brightness

1. Select [: Viewfinder brightness].

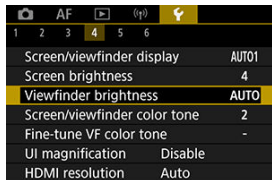

2. Turn the < > dial and select either [Auto] or [Manual].



Auto

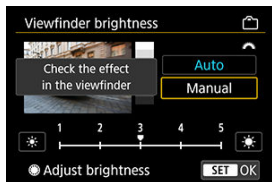

- Press the < > button. Check the effect in the viewfinder while shooting.

Manual



- Turn the < > dial to adjust viewfinder brightness, then press the < > button. Check the effect in the viewfinder.

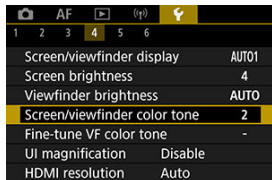

Screen and Viewfinder Color Tone

1. Select [: Screen/viewfinder color tone].

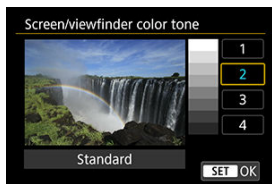

2. Make the adjustment.



- Turn the < > dial to select an item, then press the < > button.

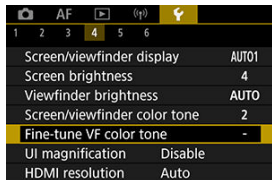

Fine-Tuning Viewfinder Color Tone

1. Select [: Fine-tune VF color tone].

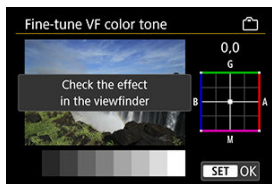

2. Make the adjustment.



- Referring to the gray image, use < > for adjustment, then press the < > button. Check the effect in the viewfinder.

UI Magnification

You can magnify menu screens by double-tapping with two fingers. Double-tap again to restore the original display size.

1. Select [: UI magnification].

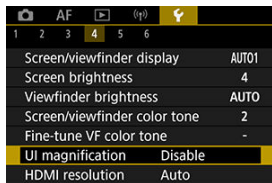

2. Select [Enable].

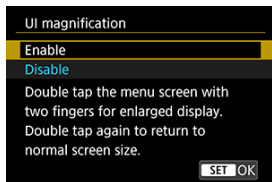

Caution

- Use camera controls when configuring menu functions with the display magnified. Touch-screen operations are not supported.

HDMI Resolution

Set the image output resolution used when the camera is connected to a television or external recording device with an HDMI cable.

1. Select [: HDMI resolution].

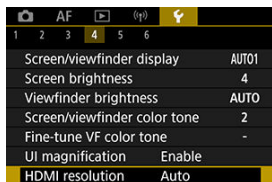

2. Select an option.

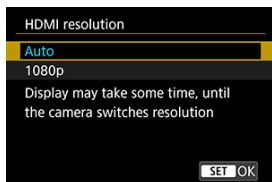

- **Auto**
The images will automatically be displayed at the optimum resolution matching the connected television.
- **1080p**
Output at 1080p resolution. Select if you prefer to avoid display or delay issues when the camera switches resolution.

1. Select [**T**: Touch control].

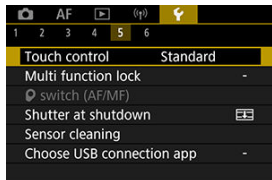

2. Select an option.



- [Sensitive] makes the touch-screen panel more responsive than [Standard].
- To disable touch operations, select [Disable].

! Caution

Precautions for touch-screen panel operations

- Do not use sharp objects such as fingernails or ballpoint pens for touch operations.
- Do not use wet fingers for touch operations. If the screen has any moisture or if your fingers are wet, the touch-screen panel may not respond or malfunction may occur. In this case, turn off the power and wipe off the moisture with a cloth.
- Attaching a commercially available protective sheet or a sticker on the screen may impair responsiveness to touch operations.
- The camera may not respond as well if you quickly perform touch operation when [Sensitive] is set.

Multi-Function Lock

Specify camera controls to lock when the Multi-function lock is enabled. This can help prevent accidentally changing settings.

1. Select [: Multi function lock].

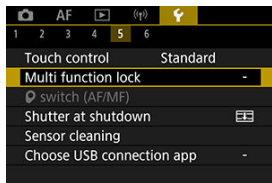

2. Select camera controls to lock.



- Press the < > button to add a checkmark [✓].
- Select [**OK**].
- Pressing the <**LOCK**> button locks the selected [✓] camera controls.

Note

- An asterisk "*" to the right of [: Multi function lock] indicates that the default setting has been modified.

Focus Mode Switch (AF/MF)

When an RF lens without a focus mode switch is attached, you can configure operation of the camera's focus mode switch.

1. Select [**F**: **⦿** switch (AF/MF)].

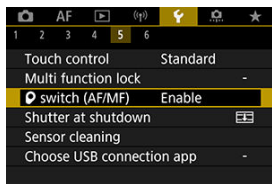

2. Select an option.

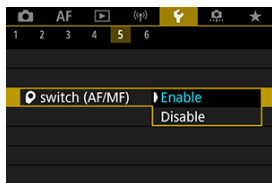

- **Enable**
Enables the camera's focus mode switch.
- **Disable**
Disables the camera's focus mode switch. In this case, set [**AF**] or [**MF**] in [**AF: Focus mode**] (ⓘ). This can help prevent accidentally changing settings.

Shutter at Shutdown

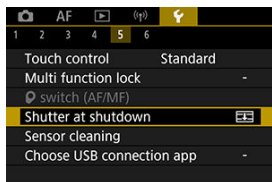

You can set whether to leave the shutter open or close it when the camera's power switch is set to <OFF>.

1. Select [: Shutter at shutdown].

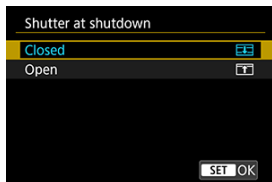

2. Select an option.



- : **Closed**
Closes the shutter. Normally set to closed, to prevent dust from adhering to the sensor when you switch lenses.
- : **Open**
Leaves the shutter open. This keeps camera quieter when the power switch is set to <ON> or <OFF>. Useful when you want to shoot quietly.

Note

- Regardless of the setting, the shutter remains as it is when auto power off is activated.

Sensor Cleaning

[Cleaning Now](#)

[Cleaning Automatically](#)

[Cleaning Manually](#) ☆

The camera's sensor cleaning feature cleans the front of the image sensor.

Note

- For best results, clean with the camera in a stable position on a desk or other flat surface.

Cleaning Now

1. Select [: Sensor cleaning].

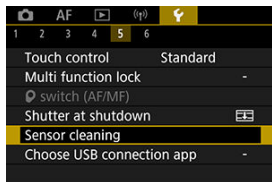

2. Select [Clean now.].

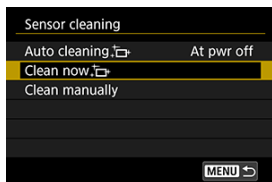

- Select [OK] on the confirmation screen.

Note

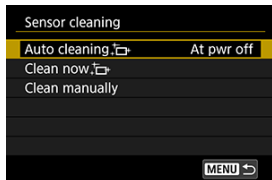

- Even if you repeat the sensor cleaning, the result will not improve much. Note that [Clean now.] may not be available immediately after cleaning.

1. Select [Auto cleaning, ].

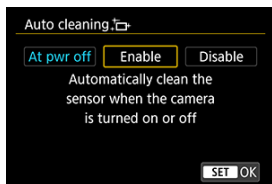

2. Select an option.



- Turn the <  > dial to select an option, then press the <  > button.

Note

- When set to [At pwr off] or [Enable], the sensor is cleaned when the screen goes off, including when it has been turned off automatically.

Dust that could not be removed by automatic cleaning can be removed manually with a commercially available blower or similar tool.

Always use a fully charged battery.

The image sensor is extremely delicate. If the sensor needs to be cleaned directly, having it done by a Canon Service Center is recommended.

1. Select [Clean manually].

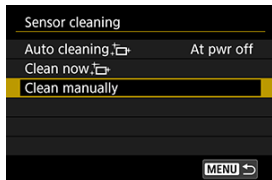

2. Select [OK].

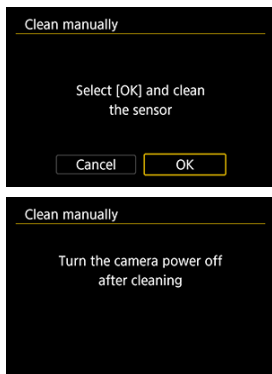

3. Remove the lens and clean the sensor.

4. End the cleaning.

- Set the power switch to < OFF >.



Note

- Using the household power outlet accessories (sold separately) is recommended.



Caution

- **While cleaning the sensor, never do any of the following. If the power is cut off, the shutter will close. These may result in damaging the image sensor and shutter curtains.**
 - **Setting the power switch to < OFF >.**
 - **Removing or inserting the battery.**
- The surface of the image sensor is extremely delicate. Clean the sensor with care.
- Use a plain blower without any brush attached. A brush can scratch the sensor.
- Do not insert the blower tip inside the camera beyond the lens mount. If the power is turned off, the shutter will close and the shutter curtains may get damaged.
- Never use pressurized air or gas to clean the sensor. Pressurized air may damage the sensor, and sprayed gas may freeze on the sensor and scratch it.
- If the battery level becomes low while cleaning the sensor, the beeper will sound as a warning. Stop cleaning the sensor.
- If a smudge that cannot be removed with a blower remains, having the sensor cleaned by a Canon Service Center is recommended.

App Selection for USB Connections

By connecting the camera to a smartphone or computer with the interface cable, you can transfer images or import images to the smartphone or computer.

1. Select [: Choose USB connection app].

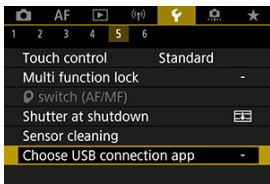

2. Select an option.



- **Photo Import/Remote Control**
Select if you will use EOS Utility after connecting to a computer, or if you will use dedicated Android apps or the iOS version of Photos.
- **Canon app(s) for iPhone**
Select if you will use an iOS app.
Connecting the camera to a smartphone requires a cable for this purpose.

The camera's settings for shooting functions and menu functions can be restored to their defaults.

1. Select [: Reset camera].

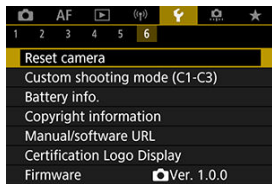

2. Select an option.

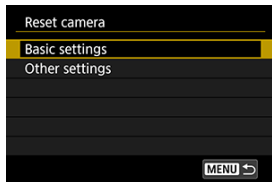

- **Basic settings**
Restores default settings for camera shooting functions and menu settings.
- **Other settings**
Settings for individual selected options can be reset.

3. Clear the settings.

- Select [**OK**] on the confirmation screen.



Note

- Still photo Custom shooting modes are reset when [**Custom shooting mode (C1-C3)**] in [**Other settings**] is selected in still photo shooting mode, and movie Custom shooting modes are reset when this option is selected in movie recording mode.

[Automatic Update of Registered Settings](#)

[Canceling Registered Custom Shooting Modes](#)

You can register current camera settings such as shooting, menu, and Custom Function settings as Custom shooting modes assigned to < **C1** > to < **C3** > modes. You can register different functions to use when shooting still photos or movies.

1. Select [**C**: Custom shooting mode (C1-C3)].

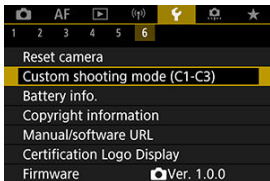

2. Select [Register settings].

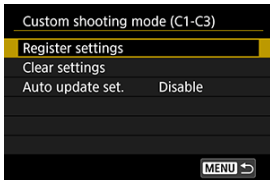

3. Register the desired items.

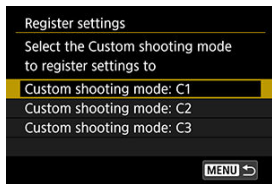

- Select the Custom shooting mode to register, then select **[OK]** on the **[Register settings]** screen.
- The current camera settings are registered to Custom shooting mode C*.
- Custom shooting mode icons change to **[C1]**, **[C2]**, and **[C3]** for movie recording.

Automatic Update of Registered Settings

If you change a setting while shooting in Custom shooting mode, the mode can be automatically updated with the new setting (Auto update). To enable this automatic update, set **[Auto update set.]** to **[Enable]** in step 2.

Canceling Registered Custom Shooting Modes

If you select **[Clear settings]** in step 2, the settings of each mode can be restored to default settings, as they were before registration.



Note

- You can also change shooting and menu settings in Custom shooting modes.

Battery Information

- ☑ [Registering Batteries to the Camera](#)
- ☑ [Labeling Batteries with Serial Numbers](#)
- ☑ [Checking the Remaining Capacity of a Registered Battery Not in Use](#)
- ☑ [Deleting the Registered Battery Information](#)

You can check the conditions of the battery you are using. By registering multiple batteries to the camera, you can check their approximate remaining capacity and usage history.

1. Select [🔋: Battery info.].

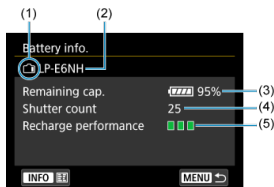
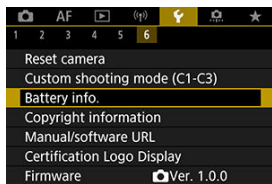

- (1) Battery position
- (2) Model of battery or household power source used.
- (3) Battery level indicator (🔋) with the remaining battery level, in 1% increments.
- (4) The number of shots taken with the current battery. The number is reset when the battery is charged.
- (5) State of battery recharge performance, in three levels.
 - 🟢🟢🟢 (Green): Battery recharge performance is good.
 - 🟢🟡🟡 (Green): Battery recharge performance is slightly degraded.
 - 🟡🔴🔴 (Red): Purchasing a new battery is recommended.

 **Caution**

- Using a genuine Canon Battery Pack LP-E6NH/LP-E6N is recommended. If you use batteries that are not genuine Canon products, the camera's full performance may not be attained or malfunction may result.

 **Note**

- The shutter count is the number of still photos taken (not including movie recording).
- If a battery communication error message is displayed, follow the instructions in the message.

Registering Batteries to the Camera

You can register up to six LP-E6NH/LP-E6N/LP-E6 battery packs to the camera. To register multiple batteries to the camera, follow the procedure below for each battery.

1. Press the <INFO> button.

- With the battery info. screen displayed, press the <INFO> button.
- If the battery is not registered, it will be grayed out.

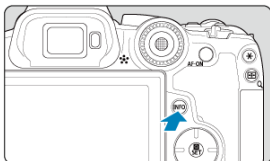

2. Select [Register].

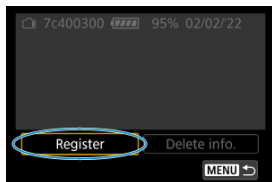

3. Select [OK].

- The battery is now displayed in white.

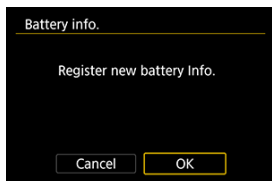

Labeling Batteries with Serial Numbers

It is convenient to label registered LP-E6NH/LP-E6N/LP-E6 battery packs with their serial numbers, using commercially available labels.

1. On a label approx. 25×15 mm, write the serial number (1).

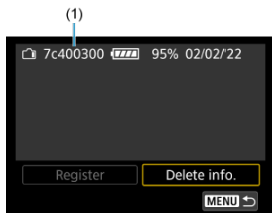

2. Apply the label.

- Set the power switch to < OFF >.
- Remove the battery from the camera.
- Apply the label as shown in the illustration (on the side with no electrical contacts).

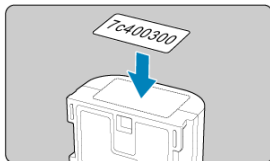

Caution

- Do not apply the label on any part other than as shown in the illustration in step 2. Otherwise, the misplaced label may make it difficult to insert the battery or impossible to turn on the power.

Checking the Remaining Capacity of a Registered Battery Not in Use

You can check the remaining capacity of batteries not currently in use, as well as their last date of use.

1. Find the matching serial number.

- On the battery history screen, find the battery serial number (1) matching the serial number that the battery is labeled with.
- You can check the respective battery's approximate remaining capacity (2) and the date when it was last used (3).

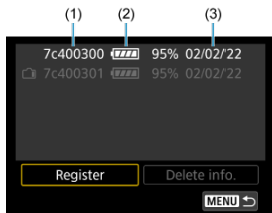

Deleting the Registered Battery Information

1. Select [Delete info.].

- In [Registering Batteries to the Camera](#), select **[Delete info.]** in step 2.

2. Select the battery information to delete.

- [✓] is displayed.

3. Press the <  > button.

- Select **[OK]** on the confirmation screen.

[☑ Checking the Copyright Information](#)

[☑ Deleting the Copyright Information](#)

When you set the copyright information, it will be recorded to the image as Exif information.

⚠ Caution

- If the entry for "Author" or "Copyright" is long, it may not be displayed entirely when you select **[Display copyright info.]**.

📱 Note

- You can also set or check copyright information with EOS Utility (EOS software, [📄](#)).

1. Select [**🔑**: Copyright information].

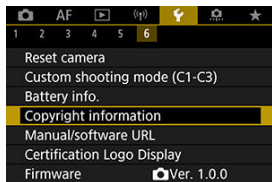

2. Select an option.



3. Enter text.

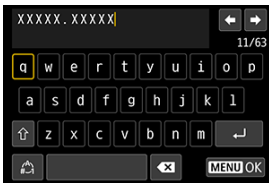

- Use the <⦿> dial or <✱> to select a character, then press the <Ⓜ> button to enter it.
- By selecting [↕], you can change the input mode.
- To delete single characters, select [✖] or press the <🗑️> button.

4. Exit the setting.

- Press the <MENU> button, then press [OK].

Checking the Copyright Information

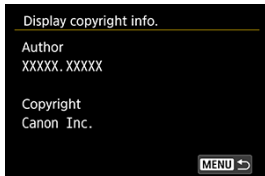

When you select [**Display copyright info.**] in step 2, you can check the [**Author**] and [**Copyright**] information that you entered.

Deleting the Copyright Information

When you select **[Delete copyright information]** in step 2, you can delete the **[Author]** and **[Copyright]** information.

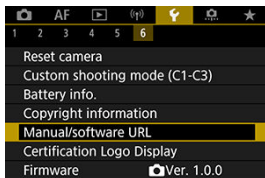

- **Manual/software URL**

To download instruction manuals, select [**👉**: **Manual/software URL**] and scan the displayed QR code with a smartphone. You can also use a computer to access the website at the URL displayed and download software.

- **Certification Logo Display ☆**

Select [**👉**: **Certification Logo Display**] to display some of the logos of the camera's certifications. Other certification logos can be found on the camera body and packaging.

- **Firmware**

Select [**👉**: **Firmware**] to update the firmware of the camera, lens, or other compatible accessories in use.

Custom Functions/My Menu

You can fine-tune camera functions and change the functionality of buttons and dials to suit your shooting preferences. You can also add menu items and Custom Functions that you adjust frequently to My Menu tabs.

- [Tab Menus: Custom Functions](#)
- [Custom Function Setting Items](#)
- [Tab Menus: My Menu](#)
- [Registering My Menu](#)

Tab Menus: Custom Functions

● Custom Functions 1

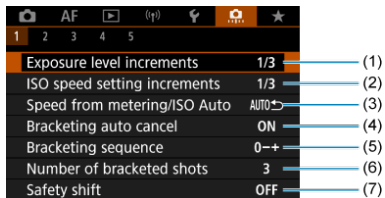

- (1) [Exposure level increments](#)
- (2) [ISO speed setting increments](#)
- (3) [Speed from metering/ISO Auto](#)
- (4) [Bracketing auto cancel](#)
- (5) [Bracketing sequence](#)
- (6) [Number of bracketed shots](#)
- (7) [Safety shift](#)

● Custom Functions 2

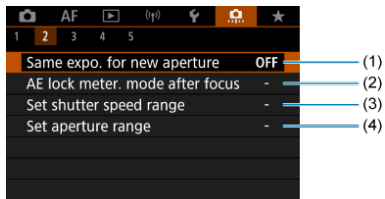

- (1) [Same expo. for new aperture](#)
- (2) [AE lock meter. mode after focus](#)
- (3) [Set shutter speed range](#)
- (4) [Set aperture range](#)

● Custom Functions 3

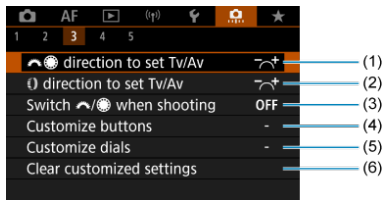

- (1) [\[sunburst icon\] direction to set Tv/Av](#)
- (2) [\[circular arrow icon\] direction to set Tv/Av](#)
- (3) [Switch \[sunburst icon\] / \[circular arrow icon\] when shooting](#)
- (4) [Customize buttons](#)
- (5) [Customize dials](#)
- (6) [Clear customized settings](#)

● Custom Functions 4

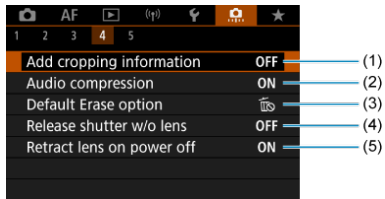

- (1) [Add cropping information](#)
- (2) [Audio compression](#)
- (3) [Default Erase option](#)
- (4) [Release shutter w/o lens](#)
- (5) [Retract lens on power off](#)

● Custom Functions 5



(1) [Clear all Custom Func. \(C.Fn\)](#)

Selecting [: **Clear all Custom Func. (C.Fn)**] clears all Custom Function settings.

Custom Function Setting Items

[C.Fn1](#)

[C.Fn2](#)

[C.Fn3](#)

[C.Fn4](#)

[C.Fn5](#)

You can customize camera features on the [] tab to suit your shooting preferences. Any settings you change from default values are displayed in blue.

Exposure level increments

Sets 1/2-stop increments for the shutter speed, aperture value, exposure compensation, AEB, flash exposure compensation, etc.

- 1/3: 1/3-stop
- 1/2: 1/2-stop



Note

- Display when set to [1/2-stop] is as follows.



ISO speed setting increments

You can change the manual ISO speed setting increment to a whole stop.

- 1/3: 1/3-stop
- 1/1: 1-stop





Note

- Even if [1-stop] is set, ISO speed will be automatically set in 1/3-stop increments when ISO Auto is set.

Speed from metering/ISO Auto

You can set the ISO speed status after the metering timer ends in cases where, for ISO Auto operation in <P>/<Tv>/<Av>/<M>/ mode, the camera has adjusted the ISO speed during metering or during the metering timer.

- **AUTO** : Restore Auto after metering
- **AUTO** : Retain speed after metering

Bracketing auto cancel

You can specify to cancel AEB and white balance bracketing when the power switch is set to <OFF>.

- **ON**: Enable
- **OFF**: Disable

Bracketing sequence

The AEB shooting sequence and white balance bracketing sequence can be changed.

- **0-+**: 0, -, +
- **-0+**: -, 0, +
- **+0-**: +, 0, -

AEB	White Balance Bracketing	
	B/A Direction	M/G Direction
0: Standard exposure	0: Standard white balance	0: Standard white balance
-: Underexposure	-: Blue bias	-: Magenta bias
+: Overexposure	+: Amber bias	+: Green bias

Number of bracketed shots

The number of shots taken with AEB and white balance bracketing can be changed. When **[Bracketing sequence]** is set to **[0, -, +]**, the bracketed shots will be taken as shown in the following table.

- **3: 3 shots**
- **2: 2 shots**
- **5: 5 shots**
- **7: 7 shots**

(1-stop/step increments)

	1st Shot	2nd Shot	3rd Shot	4th Shot	5th Shot	6th Shot	7th Shot
3: 3 shots	Standard (0)	-1	+1				
2: 2 shots	Standard (0)	±1					
5: 5 shots	Standard (0)	-2	-1	+1	+2		
7: 7 shots	Standard (0)	-3	-2	-1	+1	+2	+3

Note



- If **[2 shots]** is set, you can select the + or - side when setting the AEB range. With white balance bracketing, the second shot is adjusted toward the negative side for the B/A or M/G direction.

Safety shift

If the subject brightness changes and the standard exposure cannot be obtained within the autoexposure range, the camera will automatically change the manually selected setting to obtain the standard exposure. **[Shutter speed/Aperture]** applies to < **Tv** > or < **Av** > mode. **[ISO speed]** applies to < **P** >, < **Tv** >, or < **Av** > mode.

- **OFF: Disable**
- **Tv/Av: Shutter speed/Aperture**
- **ISO: ISO speed**

Note

- Safety shift overrides any changes to **[ISO speed range]** or **[Min. shutter spd.]** from default settings in :  **ISO speed settings** if standard exposure cannot be obtained.
- The minimum and maximum limits for the safety shift with the ISO speed are determined by **[Auto range]** . However, if the manually set ISO speed exceeds the **[Auto range]**, the safety shift will take effect up or down to the manually set ISO speed.
- Safety shift will take effect as necessary even when flash is used.

Same expo. for new aperture

The maximum aperture value may decrease (the lowest f/number may increase) in **<M>** mode (manual exposure shooting) with ISO speed set manually (except when set to ISO Auto) if you (1) Change lenses, (2) Attach an extender, or (3) Use a zoom lens with a variable maximum aperture value. This function prevents the corresponding underexposure by adjusting ISO speed or shutter speed (Tv value) automatically to maintain the same exposure as before (1), (2), or (3).

With **[ISO speed/Shutter speed]**, the ISO speed is automatically adjusted within the ISO speed range. If exposure cannot be maintained by adjusting ISO speed, shutter speed (Tv value) is automatically adjusted.

- **OFF: Disable**
- **ISO: ISO speed**
- **ISO/Tv: ISO speed/Shutter speed**
- **Tv: Shutter speed**

 **Caution**

- Does not respond to changes in effective aperture value from changes in magnification when macro lenses are used.
- Cannot provide the same exposure as before (1), (2), or (3) if **[ISO speed]** is set and the exposure cannot be maintained at speeds set in **[ISO speed range]**.
- Cannot provide the same exposure as before (1), (2), or (3) if **[Shutter speed]** is set and the exposure cannot be maintained at speeds set in **[Set shutter speed range]**.
- Shutter speed is limited to 1/8000 when **[Shutter mode]** is **[Electronic]** and **[Same expo. for new aperture]** is set to **[Shutter speed]** or **[ISO speed/Shutter speed]**.

 **Note**

- Also responds to changes in the highest f/number (minimum aperture).
- The original exposure setting is restored if you perform (1), (2), or (3) with **[ISO speed]**, **[ISO speed/Shutter speed]**, or **[Shutter speed]** set and do not adjust ISO speed, shutter speed, or aperture value before returning the camera to the original state, before (1), (2), or (3).
- Shutter speed may change to maintain exposure if the ISO speed increases to an expanded ISO speed when **[ISO speed]** is set.

AE lock meter. mode after focus

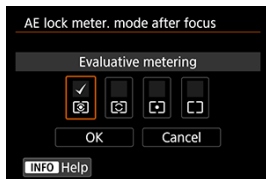

For each metering mode, you can specify whether to lock the exposure (AE lock) once subjects are in focus with One-Shot AF. The exposure will be locked while you keep pressing the shutter button halfway. Select metering modes for AE lock and add a checkmark [✓]. Select [OK] to register the setting.

Set shutter speed range

You can set the shutter speed range for each [📷: Shutter mode] option. In <Fv>, <Tv>, or <M> mode, you can set the shutter speed manually within your specified range. In <P> and <Av> mode, or in <Fv> mode with shutter speed set to [AUTO], the shutter speed is set automatically within your specified range (except for movie recording). Select [OK] to register the setting.

● Mech shutter/elec 1st-curtain

- **Lowest speed:** Can be set in a range of 30 sec.–1/4000 sec.
- **Highest speed:** Can be set in a range of 1/8000 sec.–15 sec.

● Electronic

- **Lowest speed:** Can be set in a range of 30 sec.–1/8000 sec.
- **Highest speed:** Can be set in a range of 1/16000 sec.–15 sec.

Set aperture range

You can set the aperture value range. In < **Fv** >, < **Av** >, < **M** >, or < **B** > mode, you can set the aperture value manually within your specified range. In < **P** > and < **Tv** > mode, or in < **Fv** > mode with the aperture value set to **[AUTO]**, the aperture value is set automatically within your specified range. Select **[OK]** to register the setting.

- **Max. aperture**

Can be set in a range of f/1.0–f/64.

- **Min. aperture**





Can be set in a range of f/91–f/1.4.







Note

- The available aperture value range varies depending on the lens's minimum and maximum aperture value.





direction to set Tv/Av

Dial turning direction when setting the shutter speed and aperture value can be reversed. Reverses the turning direction of the <  > and <  > dials in < **M** > shooting mode and only the <  > dial in other shooting modes. The direction of the <  > dial in < **M** > mode matches the direction to set exposure compensation in < **P** >, < **Tv** >, and < **Av** > modes.

-  : Normal
-  : Reverse direction

direction to set Tv/Av

RF lens and mount adapter control ring turning direction when setting the shutter speed and aperture value can be reversed.

-  : Normal
-  : Reverse direction

Switch when shooting

Functions assigned to the Main dial and Quick control dial can be reversed.

- **OFF: Disable**
- **ON: Enable**

Customize buttons

You can assign frequently used functions to camera buttons that are easy for you to use. Different functions, for use when shooting still photos or movies, can be assigned to the same button.

1. Select [CUSTOMIZE: Customize buttons].

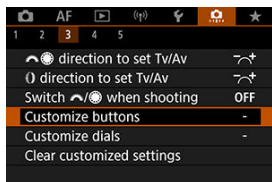

2. Select a camera control.

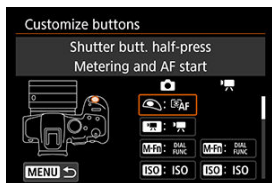

3. Select a function to assign.



- Press the <  > button to set it.
- You can configure advanced settings for functions labeled with **[INFO Detail set.]** in the lower left of the screen by pressing the < **INFO** > button.



Note

- [F10: Customize buttons] settings are not cleared even if you select [F10: Clear all Custom Func. (C.Fn)]. To clear the settings, select [F10: Clear customized settings].

Functions available for customization

AF

●: Default ○: Available for customization

AF: Metering and AF start															
●	-	●	○	-	○	○	-	-	-	-	-	-	-	-	-
AF-OFF: AF stop															
-	○	○	○	-	○	●	○	○	-	-	-	-	-	-	-
AF point selection															
-	○	○	○	●	○	○	○	○	○	○	○	○	○	○	-
Direct AF point selection															
-	-	-	-	-	-	-	-	-	-	○	○	○	○	○	●
Set AF point to center															
-	○	○	○	○	○	○	○	○	○	○	○	○	○	○	-
Start/stop tracking															
-	○	○	○	○	○	●**4	○	○	○	○	○	○	○	○	-
AF↔: Switch to registered AF func.*1															
-	-	○	○	-	○	○	-	-	-	-	-	-	-	-	-
Direct AF area selection*1															
-	○	○	○	○	○	○	○	○	○	○	○	○	○	○	-
ONE SHOT AF: One-Shot AF Servo AF*1															
-	○	○	○	○	○	○	○	○	○	○	○	○	○	○	-
Eye Detection AF*1															
-	-	○	○	-	○	○	-	-	-	-	-	-	-	-	-
Eye detection															
-	○	○	○	○	○	○	○	○	○	○	○	○	○	○	-
PEAK: Peaking															
-	○	○	○	○	○	○	○	○	○	○	○	○	○	○	-

Focus guide															
-	○	○	○	○	○	○	○	○	○	○	○	○	○	○	-
Drive mode*1															
-	○	○	○	○	○	○	○	○	○	○	○	○	○	○	-

* 1: Cannot be assigned as a function available in movie recording.

* 4: Default in movie recording.

Exposure

●: Default ○: Available for customization

			AF-ON		EB		L-Fn	ISO	M-Fn	SET					
Metering start															
○	-	-	-	-	-	-	-	-	-	-	-	-	-	-	-
AE lock															
-	○	○	○	-	○	○	○	○	-	-	-	-	-	-	-
AE lock (hold)															
-	○	○	● ^{*4}	-	○	○	○	○	-	-	-	-	-	-	-
AE lock, AF stop															
-	○	○	○	-	○	○	○	○	-	-	-	-	-	-	-
AE lock (while button pressed) ^{*1}															
○	-	-	-	-	-	-	-	-	-	-	-	-	-	-	-
AEL/FEL: AE lock/FE lock ^{*1}															
-	○	○	● ^{*3}	-	○	○	○	○	-	-	-	-	-	-	-
Release AE Lock															
-	○	○	○	-	○	○	○	○	-	-	-	-	-	-	-
Expo comp (hold btn, turn)															
-	-	○	○	-	○	○	-	-	○	-	-	-	-	-	-
ISO: ISO speed															
-	○	○	○	○	○	○	○	●	○	○	○	○	○	○	-
ISO : Set ISO speed (hold btn, turn)															
-	-	○	○	-	○	○	-	-	○	-	-	-	-	-	-
Flash firing ^{*1}															
-	○	○	○	○	○	○	○	○	○	○	○	○	○	○	-
FEL: FE lock ^{*1}															
-	○	○	○	-	○	○	○	○	-	-	-	-	-	-	-

* 1: Cannot be assigned as a function available in movie recording.

* 3: Default in still photo shooting.

* 4: Default in movie recording.

Image

●: Default ○: Available for customization

		AF-ON				L-Fn	ISO	M-Fn	SET					
: Image quality* ¹														
-	○	○	○	○	○	○	○	○	○	○	○	○	○	-
RAW/JPEG: One-touch image quality setting* ¹														
-	○	○	○	○	○	○	○	○	○	○	○	○	○	-
RAW/JPEG H: One-touch image quality (hold)* ¹														
-	○	○	○	○	○	○	○	○	○	○	○	○	○	-
: Still img aspect ratio* ¹														
-	○	○	○	○	○	○	○	○	○	○	○	○	○	-
: Auto Lighting Optimizer														
-	○	○	○	○	○	○	○	○	○	○	○	○	○	-
WB: White balance														
-	○	○	○	○	○	○	○	○	○	○	○	○	○	-
: Picture Style														
-	○	○	○	○	○	○	○	○	○	○	○	○	○	-
: Auto level* ¹														
-	○	○	○	○	○	○	○	○	○	○	○	○	○	-
: RAW burst mode* ¹														
-	○	○	○	○	○	○	○	○	○	○	○	○	○	-
: Protect														
-	○	○	○	-	○	○	○	○	-	-	-	-	-	-
★: Rating														
-	○	○	○	-	○	○	○	○	-	-	-	-	-	-
: Record func+card/folder sel.														
-	○	○	○	○	○	○	○	○	○	○	○	○	○	-

* 1: Cannot be assigned as a function available in movie recording.

Movies

●: Default ○: Available for customization

		AF-ON				L-Fn	ISO	M-Fn	SET					
Zebra* ²														
-	-	○	○	○	○	○	○	○	○	○	○	○	○	-
Movie recording														
-	●	○	○	○	○	○	○	○	-	-	-	-	-	-
<small>SERVO AF</small> : Pause Movie Servo AF														
-	○	○	○	○	○	○	○	○	○	○	○	○	○	-
Digital zoom* ²														
-	-	○	○	○	○	○	○	○	○	○	○	○	○	-
Auto level														
-	-	○	○	○	○	○	○	○	○	○	○	○	○	-

* 2: Cannot be assigned as a function available in still photo shooting.

Operation

●: Default ○: Available for customization

Flash function settings* ¹														
-	○	○	○	○	○	○	○	○	○	○	○	○	○	-
DIAL FUNC: Dial function settings														
-	○	○	○	○	○	○	○	●	○	○	○	○	○	-
Depth-of-field preview* ¹														
-	○	○	○	-	●* ³	○	○	○	-	-	-	-	-	-
AUTO: Reset selected item in Fv mode* ¹														
-	○	○	○	○	○	○	○	○	○	○	●* ³	○	●* ³	○
Alt Auto: Reset Tv/Av/ISO in Fv mode* ¹														
-	○	○	○	○	○	○	○	○	○	○	○	○	●* ³	○
Quick Control screen* ¹														
-	○	○	○	○	○	○	○	○	○	○	○	○	○	-
Magnify/Reduce														
-	○	○	○	○	○	○	○	○	○	○	○	○	○	-
Image replay														
-	○	○	○	○	○	○	○	○	○	○	○	○	○	-
Magnify images during playback														
-	○	○	○	○	○	○	○	○	○	○	○	○	○	-
Register/recall shooting func* ¹														
-	-	○	○	-	○	○	-	-	-	-	-	-	-	-
MENU: Menu display														
-	○	○	○	○	○	○	○	○	○	○	○	○	○	-
Touch Shutter* ¹														
-	○	○	○	○	○	○	○	○	○	○	○	○	○	-
Create folder* ¹														
-	○	○	○	○	○	○	○	○	○	○	○	○	○	-

OVF.VA: OVF sim. view assist*1														
-	○	○	○	○	○	○	○	○	○	○	○	○	○	-
☰: Maximize screen brightness (temp)														
-	○	○	○	○	○	○	○	○	○	○	○	○	○	-
🔌: Power off														
-	○	○	○	○	○	○	○	○	○	-	-	-	-	-
📵: Screen off														
-	○	○	○	○	○	○	○	○	○	○	○	○	○	-
🔇: Silent shutter function*1														
-	○	○	○	○	○	○	○	○	○	○	○	○	○	-
🔊: Switch focus/control ring														
-	○	○	○	○	○	○	○	○	○	○	○	○	○	-
📷: Switch between VF/screen														
-	○	○	○	○	○	○	○	○	○	○	○	○	○	-
📶: Wi-Fi/Bluetooth connection														
-	○	○	○	○	○	○	○	○	○	○	○	○	○	-
OFF: No function (disabled)														
-	○	○	○	○	○	○	○	○	○	○	●*4	●*4	●*4	○

* 1: Cannot be assigned as a function available in movie recording.



* 3: Default in still photo shooting.

* 4: Default in movie recording.

Note

- **[L-Fn]**: “AF Stop” or “Lens Function” button on super telephoto lenses with Image Stabilizer.

Customize dials

Frequently used functions can be assigned to the <  >, <  >, and <  > dials.

1. Select [: Customize dials].

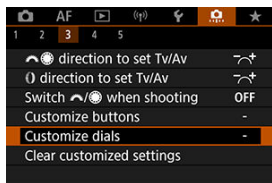

2. Select a camera control.

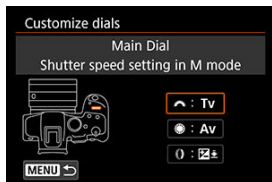

3. Select a function to assign.

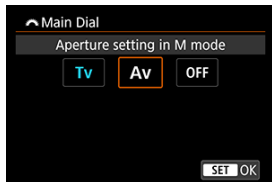

- Press the <  > button to set it.























Note

- [: **Customize dials**] settings are not cleared even if you select [: **Clear all Custom Func. (C.Fn)**]. To clear the settings, select [: **Clear customized settings**].
- Setting [: **Switch when shooting**] to [**Enable**] also changes the functions you can assign.

Functions available for dials

●: Default ○: Available for customization

	Function			
AF □	Select AF area		○	○
AF □ 	AF area (hold metering button)			○
Tv	Change shutter speed			○
Av	Change aperture value			○
	Exposure compensation		○	○
ISO	Set ISO speed		○	○
Tv 	Change shutter spd. (hold meter. btn)			○
Av 	Change aperture (hold meter. btn)			○
 	Exposure comp. (hold meter. btn)			●
ISO 	Set ISO speed (hold meter. btn)			○
 	Flash exp comp (hold meter. btn)			○
Tv	Shutter speed setting in M mode	●	○	
Av	Aperture setting in M mode	○	●	
WB	White balance selection		○	○
	Select color temperature		○	○
	Picture Style		○	○
WB 	Select WB (hold meter. btn)			○
 	Color temp. (hold meter. btn)			○
 	Select  (hold meter. btn)			○
OFF	No function (disabled)	○	○	○

Note

- <  >: Control ring on RF lenses and mount adapters.

Clear customized settings

1. Select [: Clear customized settings].

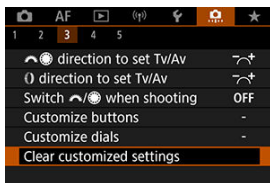

2. Select [OK].

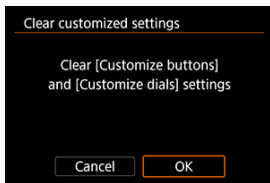

- [Customize buttons] and [Customize dials] are restored to defaults.



Add cropping information

Adding cropping information displays vertical lines for the aspect ratio specified in shooting, so that you can compose shots as if shooting with a medium- or large-format camera (6×6 cm, 4×5 inch, and so on).

When you shoot, instead of cropping images recorded to the card, the camera adds aspect ratio information to images for cropping in the Digital Photo Professional (EOS software). You can import images to Digital Photo Professional on a computer and easily crop images to the aspect ratio set at the time of shooting.

- **OFF: Disable**
- **6:6: Aspect ratio 6:6**
- **3:4: Aspect ratio 3:4**
- **4:5: Aspect ratio 4:5**
- **6:7: Aspect ratio 6:7**
- **5:6: Aspect ratio 10:12**
- **5:7: Aspect ratio 5:7**

Caution

- Cropping information can only be added when [ **Still img aspect ratio**] is set to [3:2].
- JPEG or HEIF images are not saved at the cropped size if you use the camera to process RAW images with cropping information (). In this case, RAW processing produces JPEG or HEIF images with cropping information.

Note



- Vertical lines indicating your specified aspect ratio are displayed on the screen.

Audio compression

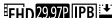

Sets audio compression for movie recording. [**Disable**] allows higher audio quality than when audio is compressed, but file sizes are larger.

- **ON: Enable**
- **OFF: Disable**



! Caution

- Editing movie files recorded with [**Disable**] and then saving them with compression will also compress the audio.
- Audio is compressed even if [**Disable**] is selected when [**Movie rec. size**] is set to  (NTSC) or  (PAL).

Default Erase option

You can set which option is selected by default in the erase menu () , which is accessed by pressing the <  > button during image playback or during review after shooting.

By setting an option other than [**Cancel**], you can simply press the <  > button to erase images quickly.

- : [**Cancel**] selected
- : [**Erase**] selected
- **RAW**: [**Erase RAW**] selected
- **J/H**: [**Erase non-RAW**] selected

! Caution

- Be careful not to erase images accidentally when an option other than [**Cancel**] is set.

Release shutter w/o lens

You can specify whether shooting still photos or movies is possible without a lens attached.

- **OFF: Disable**
- **ON: Enable**

Retract lens on power off

You can set whether to retract gear-type STM lenses (such as RF35mm F1.8 Macro IS STM) automatically when the camera's power switch is set to < **OFF** >.

- **ON: Enable**
- **OFF: Disable**

Caution

- With auto power off, the lens will not retract regardless of the setting.
- Before detaching the lens, make sure that it is retracted.

Note



- When [**Enable**] is set, this function takes effect regardless of the setting of the focus mode switch (AF or MF) on the camera or lens.

Clear all Custom Func. (C.Fn)

Selecting [: **Clear all Custom Func. (C.Fn)**] clears all Custom Function settings except [**Customize buttons**] and [**Customize dials**].



Note

- To clear settings configured with [: **Customize buttons**] and [: **Customize dials**], select [: **Clear customized settings**].

Tab Menus: My Menu

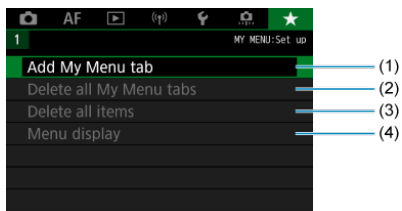

- (1) [Add My Menu tab](#)
- (2) [Delete all My Menu tabs](#)
- (3) [Delete all items](#)
- (4) [Menu display](#)

Registering My Menu

- [Creating and Adding My Menu Tabs](#)
- [Registering Menu Items on My Menu Tabs](#)
- [My Menu Tab Settings](#)
- [Deleting All My Menu Tabs/Deleting All Items](#)
- [Menu Display Settings](#)

On the My Menu tab, you can register menu items and Custom Functions you often adjust.

Creating and Adding My Menu Tabs

1. Select [Add My Menu tab].

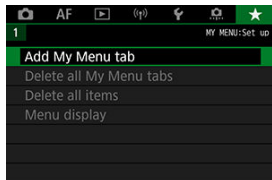

2. Select [OK].

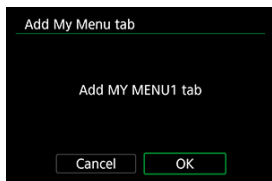

- You can create up to five My Menu tabs by repeating steps 1 and 2.

1. Select [MY MENU*: Configure].

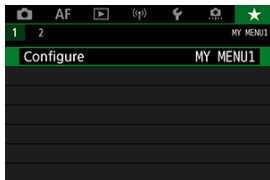

2. Select [Select items to register].

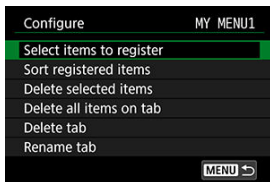

3. Register the desired items.

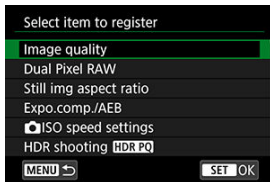



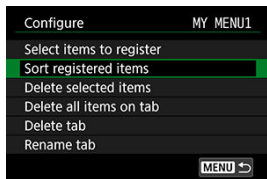

- Select an item, then press the <  > button.
- Select [OK] on the confirmation screen.
- You can register up to six items.
- To return to the screen in step 2, press the < MENU > button.

My Menu Tab Settings



You can sort and delete items on the menu tab, and rename or delete the menu tab itself.

- **Sort registered items**

You can change the order of the registered items in My Menu. Select [**Sort registered items**], select an item to rearrange, then press the <  > button. With [] displayed, turn the <  > dial to rearrange the item, then press the <  > button.

- **Delete selected items/Delete all items on tab**

You can delete any of the registered items. [**Delete selected items**] deletes one item at a time, and [**Delete all items on tab**] deletes all the registered items on the tab.

- **Delete tab**

You can delete the current My Menu tab. Select [**Delete tab**] to delete the [**MY MENU***] tab.





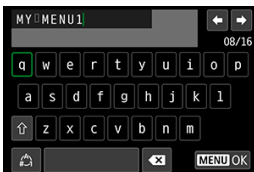

- **Rename tab**

You can rename the My Menu tab from [MY MENU*].

1. Select [Rename tab].

2. Enter text.



- Use the <  > dial or <  > to select a character, then press the <  > button to enter it.
- By selecting [], you can change the input mode.
- To delete single characters, select [] or press the <  > button.

3. Confirm input.

- Press the < **MENU** > button, then select [**OK**].

Deleting All My Menu Tabs/Deleting All Items

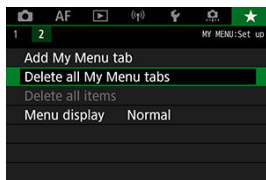

You can delete all the created My Menu tabs or My Menu items registered on them.

- **Delete all My Menu tabs**

You can delete all My Menu tabs you created. When you select [**Delete all My Menu tabs**], all the tabs from [**MY MENU1**] to [**MY MENU5**] will be deleted and the [**★**] tab will revert to its default.

- **Delete all items**

You can delete all the items registered under the [**MY MENU1**] to [**MY MENU5**] tabs. The tabs themselves will remain.

Caution

- Performing [**Delete tab**] or [**Delete all My Menu tabs**] will also delete tab names renamed with [**Rename tab**].

Menu Display Settings

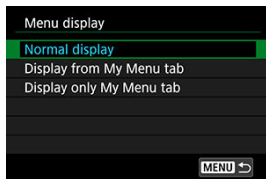

You can select [**Menu display**] to set the menu screen that is to appear first when you press the <MENU> button.

- **Normal display**
Displays the last displayed menu screen.
- **Display from My Menu tab**
Displays with the [★] tab selected.
- **Display only My Menu tab**
Restricts display to the [★] tab ([📷]/[AF]/[▶]/[⏪]/[⏩]/[🔍] tabs are not displayed).

Reference

This chapter provides reference information on camera features.

- [Importing Images to a Computer](#)
- [Importing Images to a Smartphone](#)
- [Using a USB Power Adapter to Charge/Power the Camera](#)
- [Troubleshooting Guide](#)
- [Error Codes](#)
- [ISO Speed in Movie Recording](#)
- [Information Display](#)
- [Specifications](#)

Importing Images to a Computer

[Connecting to a Computer with an Interface Cable](#)

[Using a Card Reader](#)

[Connecting to a Computer via Wi-Fi](#)

You can use EOS software to import images from the camera to a computer.

Connecting to a Computer with an Interface Cable

1. Install EOS Utility ()
2. Connect the camera to the computer.

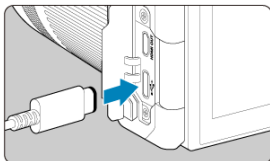

- Use an interface cable.
 - Connect the other end to a USB port on the computer.
3. Use EOS Utility to import the images.
 - Refer to the EOS Utility Instruction Manual.

Caution

- With a Wi-Fi connection established, the camera cannot communicate with the computer even if they are connected with an interface cable.

Using a Card Reader

You can use a card reader to import images to a computer.

1. **Install Digital Photo Professional** .
2. **Insert the card into the card reader.**
3. **Use Digital Photo Professional to import the images.**

- Refer to the Digital Photo Professional Instruction Manual.



Note

- When downloading images from the camera to a computer with a card reader without using EOS software, copy the DCIM folder on the card to the computer.

Connecting to a Computer via Wi-Fi

You can connect the camera to the computer via Wi-Fi and import images to the computer (☑).

Importing Images to a Smartphone



 [Preparation](#)

 [Using Camera Connect](#)

 [Using Smartphone Features](#)

You can import images captured with the camera to a smartphone by connecting the smartphone to the camera with Multi-Function Shoe Adapter for Smartphone Link AD-P1 (sold separately, for Android smartphones only) or a USB cable.

Preparation

1. Select an option in [: Choose USB connection app] ().
 - Select [**Photo Import/Remote Control**] when connecting an Android smartphone, or when connecting an iPhone and using the Photos app.
 - Select [**Canon app(s) for iPhone**] when connecting an iPhone and using Camera Connect.
 - After the settings are complete, turn the camera off.

2. Connect the camera to the smartphone with AD-P1 or a USB cable.
 - When using AD-P1, refer to the instruction manual included with AD-P1.
 - Use of a Canon USB cable (Interface Cable IFC-100U or IFC-400U) is recommended when connecting Android smartphones.
 - For details on USB cables used to connect iPhones, visit the Canon website.

1. Install Camera Connect on the smartphone and start it.

- For details on installing Camera Connect, see [Installing Camera Connect on a Smartphone](#).

2. Turn the camera on.

3. Tap [Images on camera].

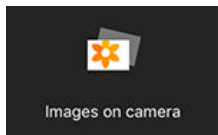

- Select images displayed to import them to the smartphone.

1. Turn the camera on.
2. Use the smartphone to import images.
 - Android smartphones: In the **[Files]** menu, select **[Canon Digital Camera ***]**, then import images in the DCIM folder.
 - iPhones: Start the Photos app, then import images from the card.

Using a USB Power Adapter to Charge/Power the Camera

Using USB Power Adapter PD-E1 (sold separately), you can charge Battery Pack LP-E6NH or LP-E6N without removing it from the camera. The camera can also be powered. **Note that Battery Pack LP-E6 cannot be charged this way.**

Charging

1. Connect the USB power adapter.

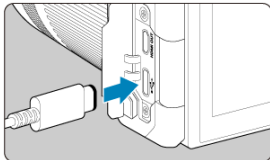

- With the camera power switch set to <OFF>, insert the USB power adapter plug fully into the digital terminal.

2. Connect the power cord.

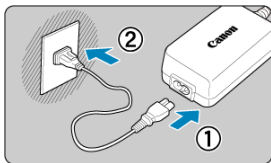

- Connect the power cord to the USB power adapter and plug the other end into a power outlet.
- Charging begins, and the access lamp (1) is lit in green.

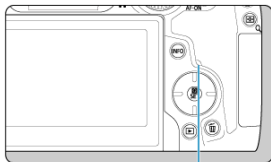

(1)

- When charging is finished, the access lamp turns off.

Supplying power

To power the camera without charging batteries, set the camera power switch to **< ON >** or **< [Power] >**. However, batteries are charged during auto power off.

The battery level indicator is gray when power is supplied.

To change from powering the camera to charging, set the camera power switch to **< OFF >**.

 **Caution**

- The camera cannot be powered unless a battery pack is in it.
- When batteries are depleted, the adapter charges them. In this case, power is not supplied to the camera.
- To protect the battery pack and keep it in optimal condition, do not charge it continuously for more than 24 hours.
- If the charging lamp fails to light up or a problem occurs during charging (shown by the access lamp blinking in green), unplug the power cord, reinsert the battery, and wait a few minutes before plugging it in again. If the problem persists, take the camera to the nearest Canon Service Center.
- The charging time required and the amount charged vary depending on ambient temperature and remaining capacity.
- For safety, charging in low temperatures takes longer.
- The remaining battery level may decline when power is supplied to the camera. To avoid running out of battery power, use a fully charged battery when shooting at regular intervals.
- Before disconnecting USB power adapters, set the camera power switch to **<OFF>**.

Troubleshooting Guide

- [✔ Power-related problems](#)
- [✔ Shooting-related problems](#)
- [✔ Problems with wireless features](#)
- [✔ Operation problems](#)
- [✔ Display problems](#)
- [✔ Playback problems](#)
- [✔ Sensor cleaning problems](#)
- [✔ Computer connection problems](#)
- [✔ Problems with the multi-function shoe](#)

If a problem occurs with the camera, first refer to this Troubleshooting Guide. If this Troubleshooting Guide does not resolve the problem, take the camera to the nearest Canon Service Center.

Power-related problems

Batteries cannot be charged with the battery charger.

- If the battery's remaining capacity ([✔](#)) is 94% or higher, the battery will not be charged.
- Do not use any battery packs other than a genuine Canon Battery Pack LP-E6NH/LP-E6N/LP-E6.
- In case of charging or charger issues, see [Charging the Battery](#).

The charger's lamp blinks at high speed.

- Constant, rapid orange blinking of the lamp indicates that a protection circuit has stopped charging because (1) there is a problem with the battery charger or battery, or (2) communication with the battery failed (with a non-Canon battery, for example). In the case of (1), unplug the charger, reinsert the battery, and wait a few minutes before plugging the charger in again. If the problem persists, take the camera to the nearest Canon Service Center.

The charger's lamp does not blink.

- For safety, hot or cold batteries inserted in the charger are not charged, and the lamp remains off. In this case, let the battery adjust to the ambient temperature before attempting to charge it again. During charging, if the battery's temperature becomes high for any reason, charging will stop automatically (lamp blinks). When the battery temperature goes down, charging will resume automatically.

Batteries cannot be charged with the USB power adapter (sold separately).

- Batteries are not charged while the camera power switch is set to < ON >. However, batteries are charged during auto power off.
- Battery Pack LP-E6 cannot be charged.
- Batteries are not charged when their remaining capacity is already approx. 94% or higher.
- Operating the camera will stop charging in progress.

The access lamp blinks during charging with the USB power adapter.

- In case of charging problems, the access lamp blinks in green and a protective circuit stops charging. In this case, unplug the power cord, reattach the battery, and wait a few minutes before plugging it in again. If the problem persists, take the camera to the nearest Canon Service Center.
- If batteries are hot or cold, the access lamp blinks in green and a protective circuit stops charging. In this case, let the battery adjust to the ambient temperature before attempting to charge it again.

The access lamp is not lit during charging with the USB power adapter.

- Try unplugging the USB power adapter and plugging it in again.

The camera cannot be powered with the USB power adapter.

- Check the battery compartment. The camera cannot be powered without a battery pack.
- Check the remaining battery level. When batteries are depleted, the adapter charges them. In this case, power is not supplied to the camera.

The camera is not activated even when the power switch is set to < ON >.

- Make sure the battery is inserted properly in the camera (🔍).
- Make sure the card slot cover is closed (🔍).
- Charge the battery (🔍).

The access lamp still lights or blinks even when the power switch is set to <OFF>.

- If the power is turned off while an image is being recorded to the card, the access lamp will remain on or continue to blink for a few seconds. When the image recording is complete, the power will turn off automatically.

[Battery communication error. Does this battery/do these batteries display the Canon logo?] is displayed.

- Do not use any battery packs other than a genuine Canon Battery Pack LP-E6NH/LP-E6N/LP-E6.
- Remove and install the battery again (🔧).
- If the electrical contacts are dirty, use a soft cloth to clean them.

The battery becomes exhausted quickly.

- Use a fully charged battery (🔋).
- The battery performance may have degraded. See [🔋: Battery info.] to check the battery recharge performance level (🔋). If the battery performance is poor, replace the battery with a new one.
- The number of available shots will decrease with any of the following operations:
 - Pressing the shutter button halfway for a prolonged period
 - Activating the AF frequently without taking a picture
 - Using the lens's Image Stabilizer
 - Using the wireless communication functions

The camera turns off by itself.

- Auto power off is in effect. To deactivate auto power off, set [Auto power off] in [🔋: Power saving] to [Disable] (🔋).
- Even if [Auto power off] is set to [Disable], the screen and viewfinder will still turn off after the camera is left idle for the time set in [Screen off] or [Viewfinder off] (although the camera itself remains on).

Shooting-related problems

The lens cannot be attached.

- To attach EF or EF-S lenses, you will need a mount adapter. The camera cannot be used with EF-M lenses (🔗).

No images can be shot or recorded.

- Make sure the card is properly inserted (🔗).
- Slide the card's write-protect switch to the Write/Erase setting (🔗).
- If the card is full, replace the card or delete unnecessary images to make space (🔗, 🔗).
- Shooting is not possible if the AF point turns orange when you attempt to focus. Press the shutter button halfway again to refocus automatically, or focus manually (🔗, 🔗).

The card cannot be used.

- If a card error message is displayed, see [Inserting/Removing Cards](#) and [Error Codes](#).

An error message is displayed when the card is inserted in another camera.

- Since SDXC cards are formatted in exFAT, if you format a card with this camera and then insert it into another camera, an error may be displayed and it may not be possible to use the card.

The image is out of focus or blurred.

- Set the focus mode to < AF > (🔗).
- Press the shutter button gently to prevent camera shake (🔗).
- With a lens equipped with an Image Stabilizer, set the Image Stabilizer switch to < ON >.
- In low light, the shutter speed may become slow. Use a faster shutter speed (🔗), set a higher ISO speed (🔗), use flash (🔗), or use a tripod.
- See [Minimizing blurred photos](#).

I cannot lock the focus and recompose the shot.

- Set the AF operation to One-Shot AF (🔗). Shooting with the focus locked is not possible with Servo AF (🔗).

The continuous shooting speed is slow.

- High-speed continuous shooting may be slower depending on the battery level, ambient temperature, flicker reduction, shutter speed, aperture value, subject conditions, brightness, AF operation, type of lens, use of flash, shooting settings, and other conditions. For details, see [Selecting the Drive Mode](#) or [Still photo file size / Number of shots available](#).

The maximum burst during continuous shooting is lower.

- Shooting intricate subjects such as fields of grass may result in larger file sizes, and the actual maximum burst may be lower than the guidelines in [Still photo file size / Number of shots available](#).

Even after I change the card, the maximum burst displayed for continuous shooting does not change.

- Estimated maximum burst indicated in the viewfinder does not change when you switch cards, even if you switch to a high-speed card. Maximum burst listed in [Still photo file size / Number of shots available](#) is based on the standard Canon test card, and the actual maximum burst is higher for cards with faster writing speeds. For this reason, estimated maximum burst may differ from actual maximum burst.

High-speed display is not available during high-speed continuous shooting.

- Refer to the high-speed display requirements in [High-Speed Display](#).

The aspect ratio cannot be set.

- Aspect ratios cannot be set when [: **Add cropping information**] is set to an option other than [**Disable**].

ISO 100 cannot be set for still photo shooting.

- The minimum speed in the ISO speed range is ISO 200 when [: **Highlight tone priority**] is set to [**Enable**] or [**Enhanced**].

Expanded ISO speeds cannot be selected for still photo shooting.

- Check the [ISO speed range] setting under [📷: ISO speed settings].
- Expanded ISO speeds are not available when [📷: Highlight tone priority] is set to [Enable] or [Enhanced].
- Expanded ISO speeds are not available when [📷: HDR shooting HDR PQ] is set to [Enable].

Even if I set a decreased exposure compensation, the image comes out bright.

- Set [📷: Auto Lighting Optimizer] to [Disable] (🔒). When [Low], [Standard], or [High] is set, even if you set a decreased exposure compensation or flash exposure compensation, the image may come out bright.

I cannot set the exposure compensation when both manual exposure and ISO Auto are set.

- See [M: Manual Exposure](#) to set the exposure compensation.

Not all the lens aberration correction options are displayed.

- With [Digital Lens Optimizer] set to [Standard] or [High], [Chromatic aberr corr] and [Diffraction correction] are not displayed, but they are both set to [Enable] for shooting.
- During movie recording, [Digital Lens Optimizer] or [Diffraction correction] are not displayed.

Using flash in <Av> or <P> mode lowers the shutter speed.

- Set [Slow synchro] in [📷: External Speedlite control] to [1/320-1/60 sec. auto] (or [1/250-1/60sec. auto]) or [1/320 sec. (fixed)] (or [1/250 sec. (fixed)]) (🔒).

The flash does not fire.

- Make sure any flash units are securely attached to the camera.

The flash always fires at full output.

- Flash units other than EL/EX series Speedlites used in autoflash mode always fire at full output (🔗).
- The flash always fires at full output when [Flash metering mode] in external flash Custom Function settings is set to [1:TTL] (autoflash) (🔗).

Flash exposure compensation cannot be set.

- If flash exposure compensation is already set with the Speedlite, flash exposure compensation cannot be set with the camera. When the Speedlite's flash exposure compensation is canceled (set to 0), flash exposure compensation can be set with the camera.

High-speed sync is not available in < Av > or < Fv > mode.

- Set [Slow synchro] in [📷: External Speedlite control] to an option other than [1/320 sec. (fixed)] (or [1/250 sec. (fixed)]) (🔗).

Remote control shooting is not possible.

- In still photo shooting, set the drive mode to [iⓂ] or [iⓂ2] (🔗). In movie recording, set [📷: Remote control] to [Enable] (🔗).
- Check the position of the remote control's release timing switch.
- If you are using Wireless Remote Control BR-E1, see [Remote Control Shooting](#) or [Connecting to a Wireless Remote Control](#).
- Infrared remote controllers such as the RC-6 cannot be used for remote control shooting when the camera is paired via Bluetooth with a smartphone or wireless remote control. Set [Bluetooth settings] to [Disable].
- To use a remote control for time-lapse movie recording, see [Time-Lapse Movies](#).

A white [🔥] or red [🔥] icon is displayed during movie recording.

- Indicates that the camera's internal temperature is high. For details, see the information on warning indicator display in movie recording (🔗).

Movie recording stops by itself.

- If the card's writing speed is slow, movie recording may stop automatically. For details on cards that can record movies, see [Card performance requirements](#). To find out the card's writing speed, refer to the card manufacturer's website, etc.
- Perform low-level formatting to initialize the card if the card's writing or reading speed seems slow (🔗).
- Recording stops automatically once your movie reaches 6 hr. (or 1 hr. 30 min. for a High Frame Rate movie).

The ISO speed cannot be set for movie recording.

- ISO speed is set automatically in [P] recording mode. In [M] mode, you can manually set the ISO speed (☑).
- The minimum speed in the ISO speed range is ISO 200 when [Highlight tone priority] is set to [Enable] or [Enhanced].

Expanded ISO speeds cannot be selected for movie recording.

- Check the [ISO speed range] setting under [ISO speed settings].
- Expanded ISO speeds are not available when [Highlight tone priority] is set to [Enable] or [Enhanced].

The exposure changes during movie recording.

- If you change the shutter speed or aperture value during movie recording, the changes in the exposure may be recorded.
- Recording a few test movies is recommended if you intend to perform zooming during movie recording. Zooming as you record movies may cause exposure changes or lens sounds to be recorded, or loss of focus.

The image flickers or horizontal stripes appear during movie recording.

- Flickering, horizontal stripes (noise), or irregular exposures can be caused by fluorescent lighting, LED lighting, or other light sources during movie recording. Also, changes in the exposure (brightness) or color tone may be recorded. In [M] mode, using a slower shutter speed may reduce the problem. The problem may be more noticeable in time-lapse movie recording.

The subject looks distorted during movie recording.

- If you move the camera to the left or right (panning) or shoot a moving subject, the image may look distorted. The problem may be more noticeable in time-lapse movie recording.

Sound is not recorded in movies.

- Sound is not recorded in High Frame Rate movies.

A time code is not added.

- Time codes are not added when you record High Frame Rate movies with [Count up] in [📷: Time code] set to [Free run] (🔗). Additionally, no time code is added to HDMI video output (🔗).

Time codes advance faster than the actual time.

- Time codes in High Frame Rate movie recording advance 4 sec. per second (🔗).

I cannot take still photos during movie recording.

- Still photos cannot be taken during movie recording. To shoot still photos, stop recording the movie, then select a shooting mode for still photos.

I cannot record movies during still photo shooting.

- It may not be possible to record movies during still photo shooting if operations such as extended Live View display increase the camera's internal temperature. Turn off the camera or take other measures, and wait until the camera cools down.
- Reducing the movie recording size may enable recording.

The camera vibrates.

- Image stabilization by the camera may make the camera seem to vibrate. This does not indicate damage.

Cannot pair with a smartphone.

- Use a smartphone compliant with Bluetooth Specification Version 4.1 or later.
- Turn on Bluetooth from the smartphone settings screen.
- Pairing with the camera is not possible from the smartphone's Bluetooth settings screen. Install the dedicated app Camera Connect (free of charge) on the smartphone (📲).
- Pairing with a previously paired smartphone is not possible if pairing information registered for another camera remains on the smartphone. In this case, remove the camera's registration retained in the Bluetooth settings on the smartphone and try pairing again (📲).

Wi-Fi functions cannot be set.

- If the camera is connected to a computer or another device with an interface cable, Wi-Fi functions cannot be set. Disconnect the interface cable before setting any functions (📲).

A device connected with an interface cable cannot be used.

- Other devices, such as computers, cannot be used with the camera by connecting them with an interface cable while the camera is connected to devices via Wi-Fi. Terminate the Wi-Fi connection before connecting the interface cable.

Operations such as shooting and playback are not possible.

- With a Wi-Fi connection established, operations such as shooting and playback may not be possible. Terminate the Wi-Fi connection, then perform the operation.

Cannot reconnect to a smartphone.

- Even with a combination of the same camera and smartphone, if you have changed the settings or selected a different setting, reconnection may not be established even after selecting the same SSID. In this case, delete the camera connection settings from the Wi-Fi settings on the smartphone and set up a connection again.
- A connection may not be established if Camera Connect is running when you reconfigure connection settings. In this case, quit Camera Connect for a moment and then restart it.

Cannot connect via Wi-Fi to a Wi-Fi printer.



- Wi-Fi connections using the camera as an access point are not possible unless printer encryption supports WPA3.
- Update the printer firmware.
- Connect using the printer as an access point.

Operation problems



Settings change when I switch from still photo shooting to movie recording or vice versa.

- Separate settings are retained for use when shooting still photos and recording movies.









Settings cannot be changed with < >, < >, < >, < >, or < >.

- Press the < LOCK > button to release the Multi-function lock ()
- Check the [: Multi function lock] setting ()

Touch operation is not possible.

- Make sure [: Touch control] is set to [Standard] or [Sensitive] ()

A camera button or dial does not work as expected.

- In movie recording, check the [: Shutter btn function for movies] setting ()
- Check the [: Customize buttons], [: Customize dials], and [Switch   when shooting] settings (, , )

Display problems

The menu screen shows fewer tabs and items.

- Tabs and items on the menu screen vary for still photos and movies.

The display starts with [★] My Menu, or the [★] tab alone is displayed.

- [Menu display] on the [★] tab is set to [Display from My Menu tab] or [Display only My Menu tab]. Set [Normal display] (🔗).

The file name's first character is an underscore (“_”).

- Set [📷: Color space] to [sRGB]. If [Adobe RGB] is set, the first character will be an underscore (🔗).

The fourth character in the file name changes.

- [📁: File name] is set to [*** + image size]. Select either the camera's unique file name or the file name registered in User setting 1 (🔗).

The file numbering does not start from 0001.

- If the card already contains recorded images, the image number may not start from 0001 (🔗).

The shooting date and time displayed are incorrect.

- Make sure the correct date and time are set (🔗).
- Check the time zone and daylight saving time (🔗).

The date and time are not in the image.

- The shooting date and time do not appear in the image. The date and time are recorded in the image data as shooting information. When you print photos, this information can be used to include the date and time (🔗).

[###] is displayed.

- If the number of images recorded on the card exceeds the number the camera can display, [###] will be displayed.

The screen does not display a clear image.

- If the screen is dirty, use a soft cloth to clean it.
- The screen display may seem slightly slow in low temperatures or may look black in high temperatures, but it will return to normal at room temperature.

Part of the image blinks in black.

- [▶]: **Highlight alert** is set to **[Enable]** (🔗).

A red box is displayed on the image.

- [▶]: **AF point disp.** is set to **[Enable]** (🔗).

During image playback, the AF points are not displayed.

- AF points are not displayed when the following types of images are played back:
 - Images taken with Multi Shot Noise Reduction applied.
 - Cropped images.
 - Images from HDR shooting with **[Auto Image Align]** set to **[Enable]**.

The image cannot be erased.

- If the image is protected, it cannot be erased (🔗).

Still photos and movies cannot be played back.

- The camera may not be able to play back images taken with another camera.
- Movies edited with a computer cannot be played back with the camera.

Only few images can be played back.

- The images have been filtered for playback with [▶]: **Set image search conditions** (🔗). Clear the image search conditions.

Mechanical sounds or sounds of camera operations can be heard during movie playback.

- The camera's built-in microphone may also record mechanical sounds of the lens or sounds of camera/lens operations if AF operations are performed or the camera or lens is operated during movie recording. If so, it may help reduce these sounds if you use an external microphone equipped with an output plug and position it away from the camera and lens.

Movie playback stops by itself.

- Extended movie playback or movie playback under high ambient temperature may cause the camera's internal temperature to rise, and movie playback may stop automatically.
If this happens, playback is disabled until the camera's internal temperature decreases, so turn off the power and let the camera cool down a while.

The movie appears to freeze momentarily.

- Significant change in the exposure level during autoexposure movie recording may cause recording to stop momentarily until the brightness stabilizes. In this case, record in [iA/M] mode (🔗).

The movie is played in slow motion.

- High Frame Rate movies are recorded at 29.97 fps or 25.00 fps, so they are played in slow motion at 1/4 speed.

No picture appears on the television.

- Make sure [🔧: Video system] is set to [For NTSC] or [For PAL] correctly for the video system of your television.
- Make sure the HDMI cable's plug is inserted all the way in (🔗).

There are multiple movie files for a single movie recording.

- If the movie file size reaches 4 GB, another movie file will be created automatically (🔗). However, if you use an SDXC card formatted with the camera, you can record a movie in a single file even if it exceeds 4 GB.



My card reader does not recognize the card.

- Depending on the card reader used and the computer's operating system, SDXC cards may not be correctly recognized. In this case, connect the camera to the computer with the interface cable, then import the images to the computer using EOS Utility (EOS software, 🔗).

Images cannot be resized or cropped.



- This camera cannot resize JPEG S2 images, RAW images, or frame-grab images from 4K movies saved as still photos (🔗).
- This camera cannot crop RAW images or frame-grab images from 4K movies saved as still photos (🔗).

Dots of light appear on the image.

- White, red, or blue dots of light may appear in captured images if the sensor is affected by cosmic rays or similar factors. Their appearance may be reduced by performing [Clean now, : Sensor cleaning] ().

Sensor cleaning problems

The shutter makes a sound during sensor cleaning.

- Although there is a mechanical sound from the shutter during cleaning after [**Clean now** ] is selected, no image is recorded to the card ().

Automatic sensor cleaning does not work.

- Repeatedly turning the power switch < **ON** > and < **OFF** > within a short period may prevent the [] icon from being displayed ().

I cannot import images to a computer.

- Install EOS Utility (EOS software) on the computer (🔗).
- Make sure the main EOS Utility window is displayed.
- If the camera is already connected via Wi-Fi, it cannot communicate with any computer connected with an interface cable.
- Check the version of the application.

Communication between the connected camera and computer does not work.

- When using EOS Utility (EOS software), set [📷: Time-lapse movie] to [Disable] (🔗).

A message was displayed on the screen when I attached an accessory.

- If [**Communication error Reattach accessory**] is displayed, reattach the accessory. In case this message is displayed again after reattachment, make sure the terminals of the multi-function shoe and accessory are clean and dry. If you cannot remove the dirt or moisture, contact a Canon Service Center.
- If [**Accessory unavailable status**] is displayed, check the terminals of the multi-function shoe and accessory and make sure the accessory is not damaged.

Error Codes

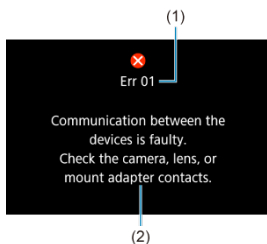

(1) Error number

(2) Cause and countermeasures

If there is a problem with the camera, an error message will appear. Follow the on-screen instructions.

If the problem persists, write down the error code (Err xx) and request service.

ISO Speed in Movie Recording

In [P], [Tv], and [Av] mode

- ISO speed is set automatically in a range of ISO 100–12800.
- Setting **[Max for Auto]** in [CAMERA]: **[ISO speed settings]** to **[H (25600)]** (🔗) expands the maximum speed in the automatic setting range to H (equivalent to ISO 25600).
- The minimum speed in the automatic setting range is ISO 200 when [CAMERA]: **[Highlight tone priority]** is set to **[Enable]** or **[Enhanced]** (🔗). The maximum limit is not expanded, even when expansion is set in **[Max for Auto]**.
- The minimum speed in the automatic setting range is ISO 800 when [CAMERA]: **[Canon Log settings]** is set to **[On (CLOG3)]** (🔗). ISO speeds lower than ISO 800 are an expanded ISO speed (L).

In [M] mode

- With ISO speed set to **[AUTO]**, ISO speed is set automatically in a range of ISO 100–12800.
- When ISO Auto is set, setting **[Max for Auto]** in [CAMERA]: **[ISO speed settings]** to **[H (25600)]** (🔗) expands the maximum speed in the automatic setting range to H (equivalent to ISO 25600).
- ISO speed can be set manually in a range of ISO 100–12800. Setting **[ISO speed range]** in [CAMERA]: **[ISO speed settings]** to **[H (25600)]** (🔗) expands the maximum speed in the manual setting range to H (equivalent to ISO 25600).
- The minimum speed in the automatic or manual setting range is ISO 200 when [CAMERA]: **[Highlight tone priority]** is set to **[Enable]** or **[Enhanced]** (🔗). Even when ISO speed expansion is set, the maximum limit will not be expanded.
- The minimum speed in the automatic setting range is ISO 800 when [CAMERA]: **[Canon Log settings]** is set to **[On (CLOG3)]** (🔗). ISO speeds lower than ISO 800 are an expanded ISO speed (L).

Information Display

[Still Photo Shooting Screen](#)

[Movie Recording Screen](#)

[Scene Icons](#)

[Playback Screen](#)

Still Photo Shooting Screen

Each time you press the <INFO> button, the information display will change.

- The display will show only the settings currently applied.

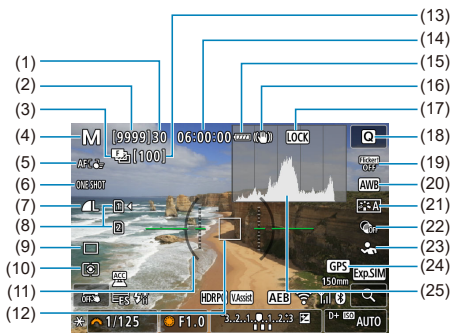

(1)	Maximum burst
(2)	Number of available shots/Sec. until self-timer shoots
(3)	Focus bracketing/HDR/Multiple exposures/Multi Shot Noise Reduction/Bulb timer/Interval timer
(4)	Shooting mode
(5)	AF area
(6)	AF operation
(7)	Image quality
(8)	Card
(9)	Drive mode
(10)	Metering mode
(11)	Electronic level
(12)	AF point (1-point AF)
(13)	No. of remaining shots for focus bracketing, multiple exposures, or interval timer
(14)	Movie recording time available
(15)	Battery level
(16)	Image Stabilizer (IS mode)
(17)	Multi-function lock warning
(18)	Quick Control button
(19)	Anti-flicker shooting
(20)	White balance/White balance correction
(21)	Picture Style
(22)	Creative filters
(23)	Subject to detect
(24)	GPS
(25)	Histogram (Brightness/RGB)

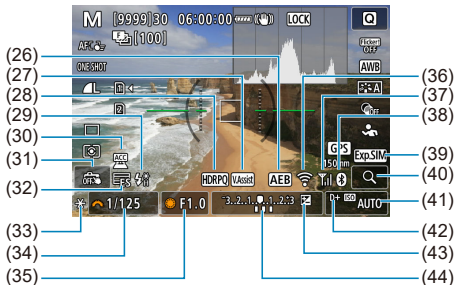

- (26) AEB/FEB
- (27) View Assist
- (28) HDR PQ
- (29) Flash ready/FE lock/High-speed sync
- (30) Accessory attached indicator
- (31) Touch Shutter/Create folder
- (32) Electronic shutter
- (33) AE lock
- (34) Shutter speed
- (35) Aperture value

Note

- You can specify the information displayed in response to pressing the <INFO> button (i).
- The electronic level is not displayed when the camera is connected via HDMI to a television.
- Other icons may be displayed temporarily after setting adjustments.
- The electronic level is not displayed when the auto level feature is set to **[Enable]**.

Movie Recording Screen

Each time you press the <INFO> button, the information display will change.

- The display will show only the settings currently applied.

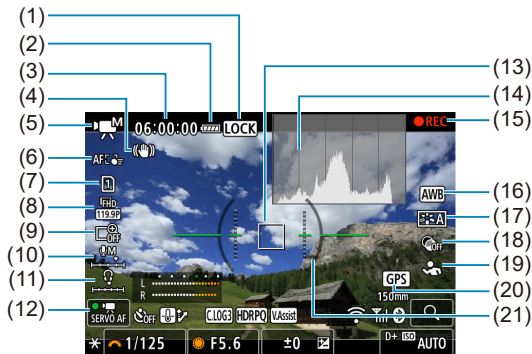

- (1) Multi-function lock warning
- (2) Battery level
- (3) Movie recording time available/Elapsed recording time
- (4) Image Stabilizer (IS mode)
- (5) Shooting mode
- (6) AF area
- (7) Card for recording/playback
- (8) Movie recording size
- (9) Digital zoom
- (10) Audio recording level (manual)
- (11) Headphone volume
- (12) Movie Servo AF
- (13) AF point (1-point AF)
- (14) Histogram (Brightness/RGB)
- (15) Movie recording in progress
- (16) White balance/White balance correction
- (17) Picture Style
- (18) Creative filters
- (19) Subject to detect
- (20) GPS
- (21) Electronic level

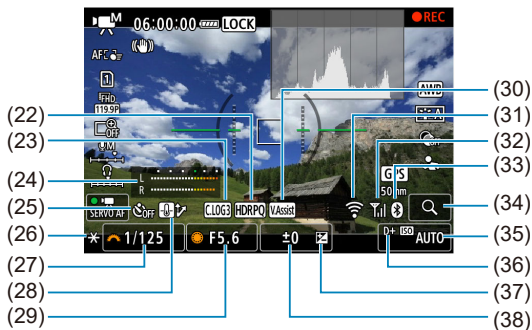

- (22) HDR PQ
 - (23) Canon Log
 - (24) Audio recording level indicator (manual)
 - (25) Movie self-timer
 - (26) AE lock
 - (27) Shutter speed
 - (28) Overheat control
 - (29) Aperture value
-
- (30) View Assist
 - (31) Wi-Fi function
 - (32) Wi-Fi signal strength
 - (33) Bluetooth function
 - (34) Magnify button
 - (35) ISO speed
 - (36) Highlight tone priority
 - (37) Exposure compensation
 - (38) Exposure level indicator (metering levels)

Caution





























- You can specify the information displayed in response to pressing the <INFO> button (🔍).
- The electronic level is not displayed when the camera is connected via HDMI to a television.
- The electronic level, grid lines, and histogram cannot be displayed during movie recording (and if they are currently displayed, recording a movie will clear the display).
- When movie recording starts, the movie recording remaining time will change to the elapsed time.

**Note**

- Other icons may be displayed temporarily after setting adjustments.

Scene Icons

In <  > shooting mode, the camera detects the type of scene and sets all settings accordingly. The detected scene type is indicated in the upper left of the screen.

Background \ Subject	People		Subjects Other Than People			Background Color
		In Motion* ¹	Nature/ Outdoor Scene	In Motion* ¹	Close* ²	
Bright						Gray
Backlit						
Blue Sky Included						Light blue
Backlit						
Sunset	* ³				* ³	Orange
Spotlight						Dark blue
Dark						
With Tripod* ¹	 * ⁴⁺⁵	* ³		* ³		

* 1: Not displayed during movie recording.

* 2: Displayed when the attached lens has distance information. With an extension tube or close-up lens, the icon displayed may not match the actual scene.

* 3: Icons of scenes selected from those that can be detected are displayed.

* 4: Displayed when all the following conditions apply.

The shooting scene is dark, it is a night scene, and the camera is mounted on a tripod.

* 5: Displayed with any of the following lenses.

- EF300mm f/2.8L IS II USM
- EF400mm f/2.8L IS II USM
- EF500mm f/4L IS II USM
- EF600mm f/4L IS II USM
- Image Stabilizer lenses released in and after 2012.

* Slower shutter speeds are used when the conditions in both *4 and *5 apply.

Note

- For certain scenes or shooting conditions, the icon displayed may not match the actual scene.

Playback Screen

Basic information display for still photos



- | | |
|------|--|
| (1) | HDR output status |
| (2) | Bluetooth function |
| (3) | Wi-Fi signal strength |
| (4) | Wi-Fi function |
| (5) | Battery level |
| (6) | Current image no./Total images/No. of images found |
| (7) | Shutter speed |
| (8) | Aperture value |
| (9) | Exposure compensation amount |
| (10) | Already sent to a computer/smartphone |
| (11) | Rating |
| (12) | Image protection |
| (13) | Card no. |
| (14) | Folder no.-File no. |
| (15) | Image quality/Edited image/Cropping/Frame Grab |
| (16) | ISO speed |
| (17) | Highlight tone priority |

 **Caution**

- If the image was taken by another camera, certain shooting information may not be displayed.
- It may not be possible to play back images taken with this camera on other cameras.

Detailed information display for still photos

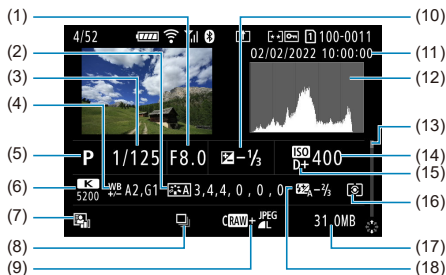

(1)	Aperture value
(2)	Picture Style/Settings
(3)	Shutter speed
(4)	White balance correction/Bracketing
(5)	Shooting mode/Multiple exposure/Frame Grab
(6)	White balance
(7)	Auto Lighting Optimizer
(8)	First image of scene
(9)	Image quality/Edited image/Cropping
(10)	Exposure compensation amount
(11)	Shooting date and time
(12)	Histogram (Brightness/RGB)
(13)	Scroll bar
(14)	ISO speed
(15)	Highlight tone priority
(16)	Metering mode
(17)	File size
(18)	Flash exposure compensation amount/Bounce/HDR shooting/Multi Shot Noise Reduction

* For images captured in RAW+JPEG/HEIF shooting, indicates RAW file sizes.

* Lines indicating the image area are displayed for images taken with the aspect ratio set (Ⓜ) and with RAW or RAW+JPEG set for image quality.

* For images with added cropping information, lines are shown to indicate the image area.

* During flash photography without flash exposure compensation, (⚡) will be displayed.

* (⚡) indicates images shot with bounce flash photography.

* The dynamic range adjustment amount is shown for images captured in HDR shooting.

* (M) indicates images captured in multiple-exposure shooting.

* (NR) indicates images processed with Multi Shot Noise Reduction.

* (Ⓜ) indicates test shots for time-lapse movies.

* (Ⓜ) indicates images created and saved by performing RAW image processing, resizing, cropping, or frame-grabbing.

* (Ⓜ) indicates images cropped and then saved.

Detailed information display for movies

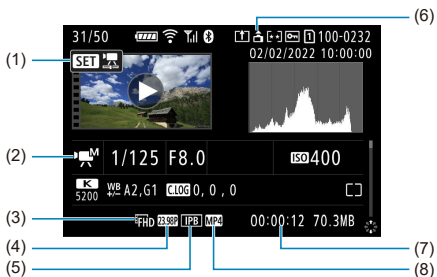

- (1) Movie playback
- (2) Movie recording mode/High Frame Rate mode
- (3) Movie recording size
- (4) Frame rate
- (5) Compression method
- (6) Movie orientation information
- (7) Recording time/Time code
- (8) Movie recording format

* For simplicity, explanations are omitted for items that are also included in basic/detailed information display for still photos, which are not shown here.

Note

- During movie playback, “*,*” is displayed for the [Fineness] and [Threshold] parameters of [Sharpness] in [Picture Style].

Specifications

Type

Type: Digital single-lens non-reflex AF/AE camera

Lens mount: Canon RF mount

Compatible lenses: Canon RF and RF-S lens groups

* Using Mount Adapter EF-EOS R: Canon EF or EF-S lenses (EF-M lenses not compatible)

Lens focal length: Approx. 1.6 times the focal length indicated on the lens

Image sensor

Type: CMOS sensor

Effective pixels*1*2	Max. approx. 32.5 megapixels
Total pixels*1	Approx. 34.4 megapixels
Screen size	Approx. 22.3 × 14.8 mm
CMOS size	APS-C
Dual Pixel CMOS AF	Supported

* 1: Rounded to the nearest 100,000.

* 2: Using RF or EF lenses.

The effective pixel count may be lower with certain lenses and image processing.

Recording system

Image recording format: Compliant with Design rule for Camera File system 2.0 and Exif 2.31*1

* 1: Supports time difference information

Image type and extension

Image type		Extension
Still photos	JPEG	JPG
	HEIF	HIF
	RAW	CR3
	Dual Pixel RAW	
	RAW burst	
	C-RAW	
Movies	ALL-I*1, IPB (Std), IPB (Light)	MP4

* 1: Time-lapse movies only

Recording media

Recording media

SD, SDHC, SDXC memory cards

SD speed class	Supported
UHS speed class	Supported
UHS-I	Supported
UHS-II	Supported

Card slot: Equipped with dual card slots

- Card slot 1: UHS-II supported
- Card slot 2: UHS-II supported

Still photo recording

Still photo pixel count

Image quality		Recorded pixels			
		Aspect ratio			
		3:2	4:3	16:9	1:1
JPEG/ HEIF	L	Approx. 32.3 megapixels (6960 × 4640)	Approx. 28.6 megapixels* ¹ (6160 × 4640)	Approx. 27.2 megapixels* ¹ (6960 × 3904)	Approx. 21.5 megapixels (4640 × 4640)
	M	Approx. 15.4 megapixels (4800 × 3200)	Approx. 13.6 megapixels* ¹ (4256 × 3200)	Approx. 12.9 megapixels* ¹ (4800 × 2688)	Approx. 10.2 megapixels (3200 × 3200)
	S1	Approx. 8.1 megapixels* ¹ (3472 × 2320)	Approx. 7.1 megapixels* ¹ (3072 × 2320)	Approx. 6.8 megapixels* ¹ (3472 × 1952)	Approx. 5.4 megapixels (2320 × 2320)
	S2	Approx. 3.8 megapixels (2400 × 1600)	Approx. 3.4 megapixels* ¹ (2112 × 1600)	Approx. 3.2 megapixels* ¹ (2400 × 1344)	Approx. 2.6 megapixels (1600 × 1600)
RAW	RAW/CRAW	Approx. 32.3 megapixels (6960 × 4640)			

























* Values for recorded pixels are rounded off to the nearest 100,000th.

* RAW/C-Raw images are generated at 3:2, with information added about the specified aspect ratio, and JPEG images are generated at the specified aspect ratio.

* These aspect ratios (M / S1 / S2) and pixel counts also apply to resizing.

* 1: Aspect ratios are slightly different for these image sizes.

Still photo file size / Number of shots available

Image quality		File size [Approx. MB]	Available shots [Approx.]* ¹
JPEG* ²	 L	10.6	2881
	 M	5.5	5549
	 M	6.0	5124
	 S1	3.2	9383
	 S1	3.7	8317
	 S1	2.1	14129
	 S2	1.8	16914
HEIF* ³	 L	10.4	2928
	 M	7.9	3871
	 M	6.3	4891
	 M	4.8	6328
	 S1	4.2	7304
	 S1	3.3	9164
	 S2	2.0	14995
RAW* ²	 RAW	35.1	873
	 CRAW	17.9	1735
RAW+JPEG* ²	 RAW +  L	35.1 + 10.6	669
	 CRAW +  L	17.9 + 10.6	1082
RAW+HEIF* ³	 RAW +  L	38.1 + 10.4	627
	 CRAW +  L	20.8 + 10.4	976

* 1: Number of shots available applies to a 32 GB card conforming to Canon testing standards.

* 2: When set to [HDR shooting **HDR PQ**: Disable].

* 3: When set to [HDR shooting **HDR PQ**: Enable].

* File size and number of shots available are measured based on Canon testing standards.

* File size and number of shots available vary depending on shooting conditions (including aspect ratio, subject, ISO speed, Picture Style, and Custom Function).

Maximum burst for continuous shooting [Approx.]

Number of shots available when set to [Drive mode:] without slower continuous shooting

Shutter mode Continuous shooting speed		Mechanical shutter / Electronic 1st-curtain Approx. 15 shots/sec.		Electronic shutter Approx. 30 shots/sec.	
Card used for recording		Standard card*1	High-speed card*2	Standard card*1	High-speed card*2
JPEG*3		184	224	117	126
		222	222	115	118
		203	203	115	120
		210	210	111	119
HEIF*4		184	190	117	122
		190	190	115	118
		190	190	115	120
		190	190	111	119
RAW*3		46	59	41	42
		105	187	87	93
RAW+JPEG*3		46	51	41	42
		101	144	84	93
RAW+HEIF*4		46	51	41	41
		101	109	84	93

* Maximum burst as measured under conditions conforming to Canon testing standards (High-speed continuous + in One-Shot AF mode, ISO 100, and Standard Picture Style).

* Number of shots available varies depending on shooting conditions (including aspect ratio, subject, memory card brand, ISO speed, Picture Style, and Custom Function).

* 1: When using a 32 GB UHS-I card that conforms to Canon testing standards.

* 2: When using a 32 GB UHS-II card that conforms to Canon testing standards.

* 3: When set to [HDR shooting **HDR PQ**: Disable].

* 4: When set to [HDR shooting **HDR PQ**: Enable].

Movie recording

Movie recording format: MP4

Estimated recording time, movie bit rate, and file size

Canon Log: Off, HDR PQ: Off

Movie recording size				Total recording time (Approx.)			Movie bit rate (Approx. Mbps)	File size (Approx. MB/min.)
Movie recording	Frame rate (fps)		Compression method	32 GB	128 GB	512 GB		
	NTSC	PAL						
4K UHD Fine	29.97 23.98	25.00	IPB (Standard)	35 min.	2 hr. 21 min.	9 hr. 27 min.	120	860
			IPB (Light)	1 hr. 10 min.	4 hr. 43 min.	18 hr. 52 min.	60	431
4K UHD	59.94	50.00	IPB (Standard)	18 min.	1 hr. 14 min.	4 hr. 56 min.	230	1647
			IPB (Light)	35 min.	2 hr. 21 min.	9 hr. 27 min.	120	860
	29.97 23.98	25.00	IPB (Standard)	35 min.	2 hr. 21 min.	9 hr. 27 min.	120	860
			IPB (Light)	1 hr. 10 min.	4 hr. 43 min.	18 hr. 52 min.	60	431
4K UHD Crop	59.94	50.00	IPB (Standard)	18 min.	1 hr. 14 min.	4 hr. 56 min.	230	1647
			IPB (Light)	35 min.	2 hr. 21 min.	9 hr. 27 min.	120	860
4K UHD (Time-lapse movies)	29.97	25.00	ALL-I	9 min.	36 min.	2 hr. 25 min.	470	3362

Full HD (High Frame Rate movies)	119.88	100.00	IPB (Standard)	35 min.	2 hr. 22 min.	9 hr. 28 min.	120	858
			IPB (Light)	1 hr. 0 min.	4 hr. 3 min.	16 hr. 15 min.	70	501
Full HD	59.94	50.00	IPB (Standard)	1 hr. 10 min.	4 hr. 43 min.	18 hr. 52 min.	60	431
			IPB (Light)	2 hr. 0 min.	8 hr. 3 min.	32 hr. 15 min.	35	252
	29.97 23.98	25.00	IPB (Standard)	2 hr. 20 min.	9 hr. 23 min.	37 hr. 35 min.	30	216
			IPB (Light)	5 hr. 47 min.	23 hr. 11 min.	92 hr. 47 min.	12	88
Full HD (Time-lapse movies)	29.97	25.00	ALL-I	47 min.	3 hr. 9 min.	12 hr. 38 min.	90	644

* Bit rate only applies to video output, not audio or metadata.

* When audio data is set to **[C.Fn 4-2 Audio compression: Enable]** (audio: AAC recording).

* Movie recording stops when the maximum recording time per movie is reached.

* Sound is not recorded for approx. the last two frames when the compression method for movie recording quality is IPB (Standard) and the camera is set to **[C.Fn 4-2 Audio compression: Enable]** or IPB (Light) (audio: AAC). Moreover, the video and sound may be slightly out of sync when movies are played back in Windows.

Canon Log: On, or HDR PQ: On

Movie recording size				Total recording time (Approx.)			Movie bit rate (Approx. Mbps)	File size (Approx. MB/min.)
Movie recording	Frame rate (fps)		Compression method	32 GB	128 GB	512 GB		
	NTSC	PAL						
4K UHD Fine	29.97 23.98	25.00	IPB (Standard)	25 min.	1 hr. 40 min.	6 hr. 40 min.	170	1218
			IPB (Light)	50 min.	3 hr. 20 min.	13 hr. 20 min.	85	610
4K UHD	59.94	50.00	IPB (Standard)	12 min.	50 min.	3 hr. 20 min.	340	2434
			IPB (Light)	25 min.	1 hr. 40 min.	6 hr. 40 min.	170	1218
	29.97 23.98	25.00	IPB (Standard)	25 min.	1 hr. 40 min.	6 hr. 40 min.	170	1218
			IPB (Light)	50 min.	3 hr. 20 min.	13 hr. 20 min.	85	610
4K UHD Crop	59.94	50.00	IPB (Standard)	12 min.	50 min.	3 hr. 20 min.	340	2434
			IPB (Light)	25 min.	1 hr. 40 min.	6 hr. 40 min.	170	1218
4K UHD (Time-lapse movies)	29.97	25.00	ALL-I	9 min.	36 min.	2 hr. 25 min.	470	3362

Full HD (High Frame Rate movies)	119.88	100.00	IPB (Standard)	23 min.	1 hr. 34 min.	6 hr. 19 min.	180	1287
			IPB (Light)	42 min.	2 hr. 50 min.	11 hr. 22 min.	100	715
Full HD	59.94	50.00	IPB (Standard)	47 min.	3 hr. 9 min.	12 hr. 36 min.	90	646
			IPB (Light)	1 hr. 24 min.	5 hr. 39 min.	22 hr. 38 min.	50	360
	29.97 23.98	25.00	IPB (Standard)	1 hr. 34 min.	6 hr. 17 min.	25 hr. 8 min.	45	324
			IPB (Light)	2 hr. 30 min.	10 hr. 3 min.	40 hr. 15 min.	28	202
Full HD (Time-lapse movies)	29.97	25.00	ALL-I	31 min.	2 hr. 6 min.	8 hr. 25 min.	135	966

* Bit rate only applies to video output, not audio or metadata.

* When audio data is set to [C.Fn 4-2 Audio compression: Enable] (audio: AAC recording).

* Movie recording stops when the maximum recording time per movie is reached.

* Sound is not recorded for approx. the last two frames when the compression method for movie recording quality is IPB (Standard) and the camera is set to [C.Fn 4-2 Audio compression: Enable] or IPB (Light) (audio: AAC). Moreover, the video and sound may be slightly out of sync when movies are played back in Windows.

Card performance requirements (movie recording) [write/read speed]

Movie recording size				SD card		
Resolution	Frame rate (fps)		Compression method	8 bit	10 bit (Canon Log 3 / HDR PQ)	
	NTSC	PAL				
4K UHD Fine 4K UHD 4K UHD Crop	59.94	50.00	IPB (Standard)	UHS Speed Class 3 or higher	Video Speed Class V60 or higher	
			IPB (Light)	UHS Speed Class 3 or higher		
	29.97 23.98	25.00	IPB (Standard)	UHS Speed Class 3 or higher		
			IPB (Light)	SD Speed Class 10 or higher	UHS Speed Class 3 or higher	
Full HD	119.88	100.00	IPB (Standard)	UHS Speed Class 3 or higher		
			IPB (Light)	SD Speed Class 10 or higher	UHS Speed Class 3 or higher	
	59.94	50.00	IPB (Standard)	SD Speed Class 10 or higher	UHS Speed Class 3 or higher	
			IPB (Light)	SD Speed Class 6 or higher	SD Speed Class 10 or higher	
	29.97 23.98	25.00	IPB (Standard)	SD Speed Class 6 or higher		
			IPB (Light)	SD Speed Class 4 or higher		
4K (Time-lapse movies)	29.97	25.00	ALL-I	Read speed of 60 MB/sec. or higher		
Full HD (Time-lapse movies)	29.97	25.00	ALL-I	Read speed of 30MB/sec. or higher		

Built-in and external microphones

Built-in microphone: Stereo microphones

External microphone (External microphone IN terminal): 3.5 mm diameter stereo mini jack

External microphone (Multi-function shoe): Compatible with Directional Stereo Microphone DM-E1D

Viewfinder

Type: OLED color electronic viewfinder

Screen size: Approx. 1.00 cm (0.39 inch)

Dot count: Approx. 2,360,000 dots

Magnification / angle of view: Approx. 1.15× / 33° (with 3:2 display, an RF50mm F1.2 L USM lens at infinity, -1 m^{-1})

Coverage: Approx. 100%

Eyepoint: Approx. 22 mm (at -1 m^{-1} from eyepiece lens end)

Dioptric adjustment: Approx. -4.0 to $+2.0 \text{ m}^{-1}$ (dpt)

Screen

Type: TFT color, liquid-crystal monitor

Screen size: Approx. 7.5 cm (3.0 inch) (screen aspect ratio of 3:2)

Dot count: Approx. 1,620,000 dots

Angle of view: Approx. 170° vertically and horizontally

Coverage: Approx. 100% vertically and horizontally (at L image quality and an aspect ratio of 3:2)

Screen brightness: Adjustable to one of seven brightness levels

Touch-screen: Capacitive sensing

HDMI output

HDMI video / audio output: HDMI micro OUT terminal (Type D)

* HDMI CEC not supported

HDMI resolution: Auto / 1080p

Autofocus

Focusing method: Dual Pixel CMOS AF

Focusing brightness range

Still photo shooting: EV -5.0 to 20

Conditions: When used with an f/1.2 lens*, center AF point, One-Shot AF, at room temperature and ISO 100

* Except for RF lenses with a Defocus Smoothing (DS) coating.

Movie recording: EV -3.5 to 20

Conditions: When used with an f/1.2 lens*, center AF point, One-Shot AF, at room temperature and ISO 100, recording in Full HD (29.97 / 25.00 fps)

* Except for RF lenses with a Defocus Smoothing (DS) coating.

Focusing operation

	Still photo shooting	Movie recording
AF operation	<ul style="list-style-type: none">• One-Shot AF• Servo AF• In A+ mode, automatically switched from One-Shot AF to Servo AF depending on the subject	<ul style="list-style-type: none">• One-Shot AF• Movie Servo AF
Manual focus	Supported	Supported

Focus mode switch: AF / MF

* Applies when an RF or RF-S lens without a focus mode switch is attached.

* When lenses with a focus mode switch are attached, the setting on the lens takes precedence.

Lens compatibility based on AF area: Refer to the Canon website

Number of AF area available for automatic selection

Focusing area	Horizontal: Approx. 100%, Vertical: Approx. 100%
Still photos	Max. 651 zones (31 × 21)
Movies	Max. 527 zones (31 × 17)

Selectable positions for AF point

Focusing area	Horizontal: Approx. 90%, Vertical: Approx. 100%	
Numbers of positions	Still photos	Max. 5915 positions (91 × 65)
	Movies	Max. 4823 positions (91 × 53)

* When set to [1-point AF] and selected using the Multi-controller.

Exposure control

Metering functions under various shooting conditions

Item		Still photo shooting	Movie recording
Metering sensor		384-zone (24×16) metering using image sensor output signals	
Metering mode	Evaluative metering	○	○ * When faces is detected
	Partial metering	○ * Approx. 6.0% in the center of the screen	
	Spot metering	○ * Approx. 3.0% in the center of the screen	
	Center-weighted average	○	○ * When face is not detected * When set to Canon Log 3
Metering brightness range (At room temperature, ISO 100)		EV -2 to 20	EV 0 to 20

ISO speed (recommended exposure index) in still photo shooting

Manual ISO speed setting for still photos

Normal ISO speed	ISO 100–32000 (in 1/3-stop or 1-stop increments)
Expanded ISO speed	H (equivalent to ISO 51200)

* ISO 200–32000 when [Highlight tone priority] is configured.

* Expanded ISO speeds cannot be set in HDR mode or for HDR shooting (HDR PQ).

Manual ISO speed setting range limits for still photos

Maximum	ISO 200–H (equivalent to ISO 51200, in 1-stop increments)
Minimum	ISO 100–32000 (in 1-stop increments)

ISO Auto setting range limits for still photos

Maximum	ISO 200–32000 (in 1-stop increments)
Minimum	ISO 100–25600 (in 1-stop increments)

ISO Auto details for still photos

Shooting mode		No flash	Using flash	
Variable control of maximum ISO Auto limit for E-TTL			Compatible lens	Incompatible lens
Creative Zone	Fv	ISO 100* ¹⁺² -32000* ²	ISO 100* ¹⁺² -6400* ²	ISO 100* ¹⁺² -1600* ²
	P			
	Tv			
	Av			
	M			
	B	ISO 400* ³	ISO 400* ³	ISO 400* ³
Basic Zone	A+	ISO 100-6400	ISO 100-6400	ISO 100-1600
	SCN	Varies by shooting mode		
		Varies by shooting mode		

* 1: ISO 200 when set to **[Highlight tone priority: Enable/Enhanced]**.

* 2: Varies depending on the **[Maximum]** and **[Minimum]** settings for **[Auto range]**.

* 3: If outside the setting range, changed to the value most close to ISO 400.

Variable control of maximum ISO Auto limit for E-TTL for still photos: Supported

ISO speed (recommended exposure index) in movie recording

Manual ISO speed setting for movies (in M mode)

	Canon Log 3	ISO speed
Normal ISO speed	Off	ISO 100–12800 (in 1/3- or 1-stop increments)
	On	ISO 800–12800 (in 1/3- or 1-stop increments)
Expanded ISO speed	Off	H (equivalent to ISO 16000–25600; in 1/3-stop increments)
	On	L (equivalent to ISO 100–640), H (equivalent to 16000–25600) (in 1/3-stop increments)

* Maximum and minimum ISO speed when set manually corresponds to the **[ISO speed range]** setting.

* The setting range is ISO 200–12800 when **[Highlight tone priority]** is configured.

* Expanded ISO speeds are not available in HDR PQ movie, HDR movie, or High Frame Rate movie recording.

* The default setting range when set to Canon Log 3 is L and ISO 800–12800.

Automatic ISO speed setting for movies (in P / Tv / Av mode, and in M [ISO Auto] mode)

	Canon Log 3	ISO speed
Normal ISO speed	Off	ISO 100–12800 (in 1/3- or 1-stop increments)
	On	ISO 800–12800 (in 1/3- or 1-stop increments)
Expanded ISO speed	Off	H (equivalent to ISO 25600)
	On	

* Maximum ISO speed when set automatically corresponds to the **[Max for Auto]** setting.

* The setting range is ISO 200–12800 when **[Highlight tone priority]** is configured.

* Expanded ISO speeds are not available in HDR PQ movie, HDR movie, or High Frame Rate movie recording.

Manual ISO speed setting range for movies

The manual ISO speed setting range (maximum and minimum) can be changed.

Maximum	ISO 200–12800 or H (equivalent to ISO 25600, in 1-stop increments)
Minimum	ISO 100–12800 (in 1-stop increments)

Maximum ISO Auto setting for movies

Max for ISO Auto	ISO 6400 / 12800 / H (equivalent to ISO 25600)
Time-lapse movies Max for ISO Auto	ISO 400–12800 (in 1-stop increments)

Shutter

Shutter functionality in still photo shooting

Type:

Electronically controlled focal-plane shutter
Rolling shutter, using the image sensor

Shutter mode

	Flash photography
Mechanical shutter	Possible
Electronic 1st curtain	Possible
Electronic shutter	Disabled

Shutter speed / X-sync speed

Shutter mode	Setting range	Setting increments	X-sync
Mechanical shutter	1/8000–30 sec., Bulb	1/3 stop, 1/2 stop	1/250 sec.
Electronic 1st curtain	1/8000–30 sec., Bulb	1/3 stop, 1/2 stop	1/320 sec.
Electronic shutter	1/16000, 1/8000–30 sec., Bulb	1/3 stop, 1/2 stop	

* 1/16000 sec. with electronic shutter is settable only in Tv or M mode. It is not available in Fv, P and Av modes or Basic Zone modes.

* Even in Tv or M mode, 1/16000 sec. with electronic shutter is not available with conditions as below.

- When setting to HDR mode or focus bracketing shooting.

- If [ISO speed/Shutter speed] or [Shutter speed] is set for Maintaining exposure when the aperture value changes.

Shutter functionality in movie recording

Type: Rolling shutter, using the image sensor

Shutter Speed:

Movie auto exposure: 1/4000–1/25*¹ sec.

Movie shutter-priority/manual exposure: 1/4000–1/8*¹ sec.

* Varies by shooting mode and frame rate.

* 1: 1/125 sec. (NTSC) or 1/100 sec. (PAL) with [High Frame Rate] set to [Enable].

External flash

Accessory shoe contacts: 21 pins for accessories compatible with the multi-function shoe, 5 pins for X-sync and communication

Flash exposure compensation: ± 3 -stops in 1/3- or 1/2-stop increments

Drive

Drive mode and continuous shooting speed

Drive modes	AF operation	Mechanical shutter	Electronic 1st curtain	Electronic shutter
Single shooting		○		
High-speed continuous shooting +	One-Shot AF	Max. approx. 15 shots/sec.	Max. approx. 15 shots/sec.	Max. approx. 30 shots/sec.
	Servo AF			
High-speed continuous shooting	One-Shot AF	Max. approx. 6.5 shots/sec.	Max. approx. 8.0 shots/sec.	Max. approx. 15 shots/sec.
	Servo AF			
Low-speed continuous shooting	One-Shot AF	Max. approx. 3.0 shots/sec.	Max. approx. 3.0 shots/sec.	Max. approx. 3.0 shots/sec.
	Servo AF			
Self-timer: 10 sec / remote control		○		
Self-timer: 2 sec / remote control		○		
Self-timer: Continuous		○		

Image stabilization (IS mode): Provided

Playback functions

Item	Still photos	Movies
AF point display	<input type="radio"/>	
Playback grid	Off / 3x3 / 6x4 / 3x3+diag	
Magnified view	1.5x–10x (15 levels)	
Set image search conditions	Search conditions Rating / Date / Folder / Protection / Type of file (1) / Type of file (2)	
Rating	OFF / ★ to ★★★★★ Select images / Select range / All images in folder / All images on card / All found images	
Protect images	Select images / Select range / All images in folder / Unprotect all images in folder / All images on card / Unprotect all images on card / All found images / Unprotect all found images	
In-camera RAW image processing	<input type="radio"/>	
Resizing	<input type="radio"/>	
Cropping	<input type="radio"/>	

Cloud RAW image processing

A feature for uploading images to image.canon for cloud-based RAW processing. Requires some preparation, such as pairing the camera and submitting information for billing purposes.

Frame grab from 4K movies

Individual frames of 4K movies recorded with this camera can be saved as approx. 8.3-megapixel (3840×2160) still photos (JPEG or HEIF*).

* From normal movies, still photos are saved as JPEGs, and from HDR PQ movies, as HEIF images.

* Movies enabling extraction: 4K Fine / 4K / 4K Crop

* Extracted still photos cannot be resized or cropped within the camera.

Print order (DPOF)

Compliant with DPOF Version 1.1

External interface

Digital terminal

Terminal type	USB Type-C
Transmission	Equivalent to SuperSpeed Plus USB (USB 3.2 Gen 2)
Applications	<ul style="list-style-type: none">• For computer communication / smartphone communication• USB battery charging / camera power supply

HDMI output terminal: HDMI micro OUT terminal (Type D)

External microphone input terminal: Equipped with the 3.5 mm diameter stereo mini jack

Headphone terminal: Equipped with the 3.5 mm diameter stereo mini jack

Remote control terminal: Remote Switch RS-60E3 type terminal supported

Power source

Battery

Compatible battery packs	LP-E6NH / LP-E6N / LP-E6
Quantity used	1

USB battery charging/Camera power supply: Using USB Power Adapter PD-E1

AC power source

Power source section	AC Adapter AC-E6N
Connected section	DC Coupler DR-E6

Number of shots available

Type of shooting	Temperature	Battery life (Approx. number of shots)	
		Power saving*1	Smooth*2
Viewfinder shooting	+23°C / 73°F	500	380
On-screen shooting		770	660

* 1: CIPA guidelines compliant.

* 2: Based on CIPA guidelines, conforming to Canon testing standards.

* Using a new, fully charged LP-E6NH, with an SD card conforming to Canon testing standards.

* The number of shots available may vary greatly depending on the shooting environment.

* Fewer shots may be available with a compatible accessory attached to the multifunction shoe, because the camera powers the accessory.

Available operating time

Conditions of use			Temperature	Available operating time
Time available for bulb exposure			+23°C / 73°F	Approx. 5 hr.
Time available for Live View display (on-screen shooting)			+23°C / 73°F	Approx. 5 hr.
Time available for movie recording * Movie Servo AF: Disable	Full HD	• IPB (Standard) • 29.97 fps / 25.00 fps	+23°C / 73°F	Approx. 3 hr. 50 min.
			0°C / 32°F	Approx. 3 hr. 30 min.
Available movie playback time (normal playback)	4K	• IPB (Standard) • 59.94 fps / 50.00 fps	+23°C / 73°F	Approx. 5 hr. 30 min.

* With a fully charged LP-E6NH

Dimensions and weight

Dimensions

(W) × (H) × (D)	Approx. 132.0 × 90.4 × 91.7 mm / 5.20 × 3.56 × 3.61 in.
-----------------	---

* Based on CIPA guidelines.

Weight

Body (including battery and card 1) * Based on CIPA guidelines.	Approx. 612 g / 21.59 oz.
Body only	Approx. 530 g / 18.70 oz.

* Not including body cap or shoe cover.

Operating environment

Operating temperature: 0–40°C / 32–104°F

Operating humidity: 85% or less

Wi-Fi (Wireless LAN) communication

Supported standards (Equivalent to IEEE 802.11b/g/n standards)

Wi-Fi standards	Transmission method	Maximum link speed
IEEE 802.11b	DSSS modulation	11 Mbps
IEEE 802.11g	OFDM modulation	54 Mbps
IEEE 802.11n		72.2 Mbps

Transmission frequency (Center frequency)

Frequency	2412 to 2462 MHz
Channels	1 to 11 ch

Authentication and data encryption methods

Connection method	Authentication	Encryption
Camera access point	WPA2 / WPA3-Personal	AES
	Open	Disable
Infrastructure	Open	WEP
		Disable
	Shared key	WEP
	WPA / WPA2 / WPA3-Personal	TKIP AES

Bluetooth

Standards compliance: Bluetooth Specification Version 4.2 compliant (Bluetooth Low Energy technology)

Transmission method: GFSK modulation

- All data above is based on Canon testing standards and CIPA (Camera & Imaging Products Association) testing standards and guidelines.
- Dimensions and weight listed above are based on CIPA Guidelines (except weight for camera body only).
- Product specifications and appearance are subject to change without notice.
- If a problem occurs with a non-Canon lens attached to the camera, contact the respective lens manufacturer.

Trademarks and Licensing

[✔ Trademarks](#)

[✔ About MPEG-4 Licensing](#)

[✔ Accessories](#)

Trademarks

- Adobe is a trademark of Adobe Systems Incorporated.
- Microsoft and Windows are trademarks or registered trademarks of Microsoft Corporation in the United States and/or other countries.
- App Store and macOS are trademarks of Apple Inc., registered in the U.S. and other countries.
- Google Play and Android are trademarks of Google LLC.
- IOS is a trademark or registered trademark of Cisco in the U.S. and other countries and is used under license.
- QR Code is a trademark of Denso Wave Inc.
- SDXC logo is a trademark of SD-3C, LLC.
- HDMI, HDMI logo, and High-Definition Multimedia Interface are trademarks or registered trademarks of HDMI Licensing LLC.
- The Wi-Fi CERTIFIED logo and the Wi-Fi Protected Setup mark are trademarks of the Wi-Fi Alliance.
- The Bluetooth® word mark and logos are registered trademarks owned by Bluetooth SIG, Inc. and any use of such marks by Canon Inc. is under license. Other trademarks and trade names are those of their respective owners.
- USB Type-C™ and USB-C™ are trademarks of USB Implementers Forum.
- All other trademarks are the property of their respective owners.



About MPEG-4 Licensing

"This product is licensed under AT&T patents for the MPEG-4 standard and may be used for encoding MPEG-4 compliant video and/or decoding MPEG-4 compliant video that was encoded only (1) for a personal and non-commercial purpose or (2) by a video provider licensed under the AT&T patents to provide MPEG-4 compliant video. No license is granted or implied for any other use for MPEG-4 standard."

THIS PRODUCT IS LICENSED UNDER THE AVC PATENT PORTFOLIO LICENSE FOR THE PERSONAL USE OF A CONSUMER OR OTHER USES IN WHICH IT DOES NOT RECEIVE REMUNERATION TO (i) ENCODE VIDEO IN COMPLIANCE WITH THE AVC STANDARD ("AVC VIDEO") AND/OR (ii) DECODE AVC VIDEO THAT WAS ENCODED BY A CONSUMER ENGAGED IN A PERSONAL ACTIVITY AND/OR WAS OBTAINED FROM A VIDEO PROVIDER LICENSED TO PROVIDE AVC VIDEO. NO LICENSE IS GRANTED OR SHALL BE IMPLIED FOR ANY OTHER USE. ADDITIONAL INFORMATION MAY BE OBTAINED FROM MPEG LA, L.L.C. SEE [HTTP://WWW.MPEGLA.COM](http://www.mpegla.com)

* Notice displayed in English as required.

Use of genuine Canon accessories is recommended

This product is designed to achieve optimum performance when used with genuine Canon accessories. Therefore, using this product with genuine accessories is highly recommended. Canon shall not be liable for any damage to this product and/or accidents such as malfunction, fire, etc. caused by the failure of non-genuine Canon accessories (e.g., a leakage and/or explosion of a battery). Please note that repairs arising out of the malfunction of non-genuine accessories will not be covered by the warranty for repairs, although you may request such repairs on a chargeable basis.

Caution

- Battery Pack LP-E6NH is dedicated to Canon products only. Using it with an incompatible battery charger or product may result in malfunction or accidents for which Canon cannot be held liable.

Check the following website for details on compatible accessories.

- <https://cam.start.canon/H002/>

