



SWITCH TO A BETTER WORLD

Delivering  
**good**  
**air**



# TRUE DEFINITION OF QUALITY

A piece of art that complements your interiors and makes it easy to maintain with an anti-dust attribute. Orisys is a true marvel, an art of class, that comes with a warranty of 3 years, a powerful motor with high-grade copper that delivers high-speed air defining the quality of breeze.

WITH EXTRA  
**COPPER** |  ANTI DUST

 **ORISYS**  
PREMIER



Scan the QR code  
to watch the video



# PURE DELIGHT TO YOUR SENSES

From soothing your mind to pleasing your eyes, the enthralling Orisys ceiling fan serves a plethora of relaxing experiences. While the exhilarating breeze leaves you completely lost in bliss and tranquility, the magnificent aesthetics steal the limelight.

WITH EXTRA  
COPPER

ANTI DUST

ORISYS  
PREMIER



Scan the QR code  
to watch the video



## A TIMELESS CLASSIC

Being the most evolved representation of a ceiling fan made with precisely engineered parts and finest raw materials, Orisys undoubtedly proves to be a timeless classic. Moreover, its elongated blades and powerful motor not only grant you ultimate serenity, but its spectacular body with lustrous surface delivers a sublime experience.

WITH EXTRA  
COPPER | ANTI DUST

ORISYS  
POSH



Scan the QR code  
to watch the video



# LET THE FRESH AIR SINK IN

Give your space a fresh look with Odyssey ceiling fans available in colours classy white-black and mesmerising shades of brown-chrome. A classic, yet dynamic ceiling fan that comes with aerodynamically designed blades with a long-lasting coat for superior and high-speed air delivery. The unique flat bottom design and sandwiched blades is something the world has never seen before!

WITH EXTRA  
COPPER

ANTI DUST

ODYSSEY  
PREMIER



Scan the QR code  
to watch the video

A RARE COMBINATION OF  
GOODNESS AND SERENITY



Add a vibe of serenity and goodness to your ambience. They not only transform your interiors with their extraordinary design, but also keep you fresh and energetic with their brilliant air delivery.

**EMBASSY**  
CEILINGFAN



Scan the QR code  
to watch the video

# CONTEMPORARY LIVING DYNAMICS



The iF Design Award is recognized as a symbol of design excellence around the world. It aims to draw attention to particularly well-designed industrial products. iF International Forum Design GmbH is one of the world's most celebrated and valued design competitions.

**AirMate**  
PEDESTAL FAN



Scan the QR code  
to watch the video



HAVING THE RIGHT FAN  
FOR THE RIGHT AMBIENCE  
IS ABSOLUTELY ESSENTIAL



Being an integral part of GM, I can assure you of its high quality standards and its dedication to serve you. GM's newest products in the category of fans such as Excel 35, Odyssey, Embassy, Orisys and more have a profound potential of fully augmenting your living experiences. I, therefore, insist on making the elite choice in technological innovations for your cherished homes and empower you to relish the luxury it concludes.

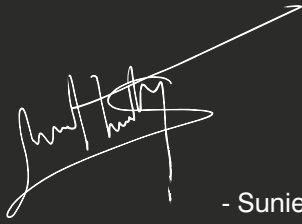

- Suniel Shetty



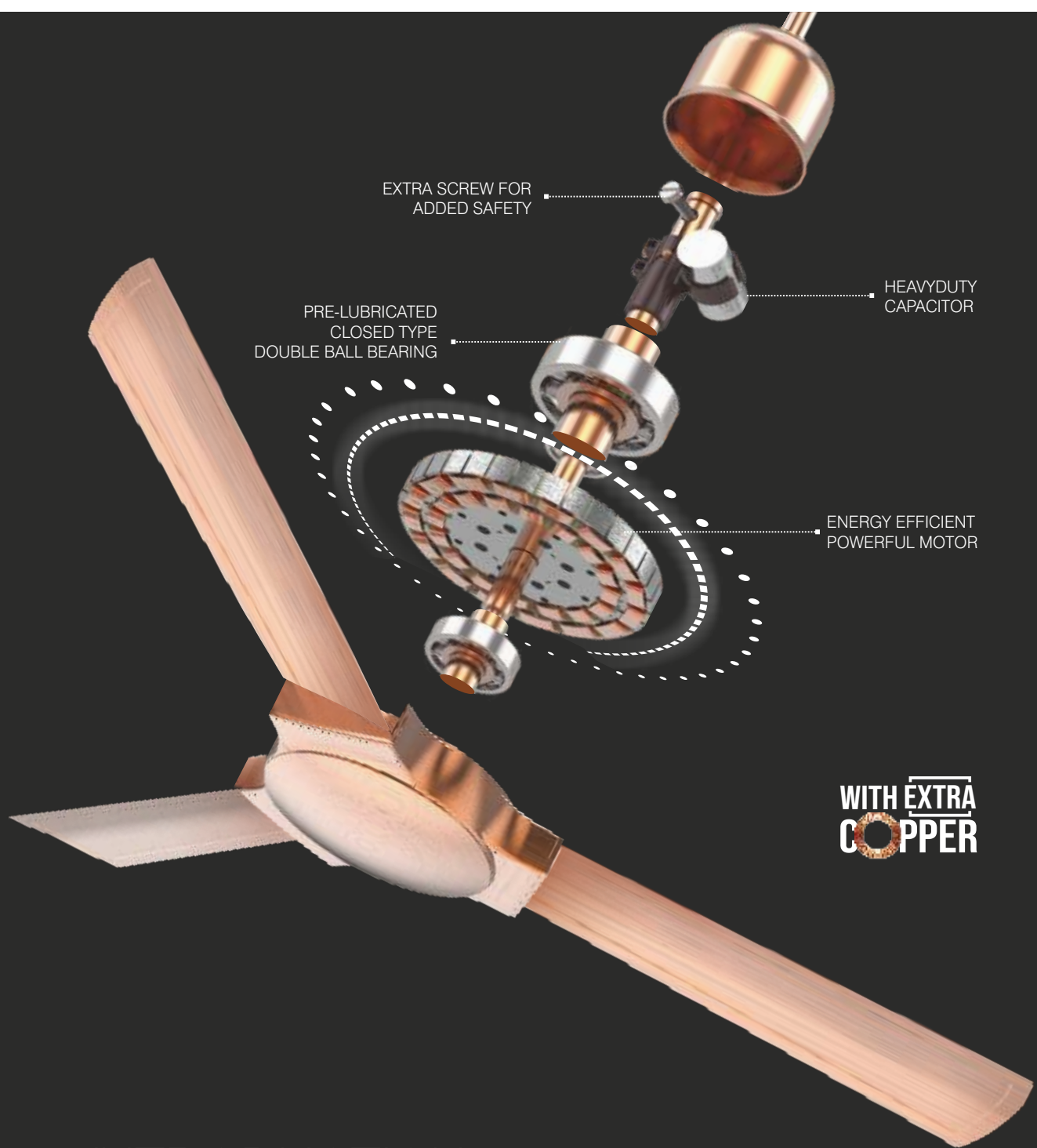

WITH EXTRA  
COPPER

## INTRODUCTION

From humble beginnings, to becoming the largest producer of switches in India, and a market leader in home electrical accessories, GM has come a long way. Starting with the switches, moving on to automation, progressively towards LEDs, we have consistently granted our customers the experience of a luxurious smart home. However, our journey of dreams to reality doesn't end here.

With the introduction of GM fans, we have extended convenience as complementary with exhilarating freshness. GM fans not only promise advanced utility, but also deliver superior aesthetics. After thorough research in design and material and studying about the concerns and the requirements of a larger audience, we have finely crafted GM fans to deliver a wholesome experience.

GM fans not only soothe the senses, but they also comfort the environment. Although we create products that are sustainable, we strongly believe in the power of recycling. Furthermore, we use local materials of superior standards to support small businesses and uplift communities. Thus, by shared efforts we create innovative products of high quality that garner high demands and great appreciation.



# A STATE OF UTMOST TRANQUILLITY

A constant flow of good vibes and freshness is what makes living truly comfortable. With sleek exteriors, powerful motor with high-grade copper for high-speed air delivery and efficiency, it is always going to be a good time with the AirDeco-400 ceiling fan! The additional designer trims add elegance to the fan further complementing your home.

**AirDeco**  
**400** CEILING FAN



Scan the QR code  
to watch the video

ITEM CODE | COLOUR | SWEEP | MRP ₹ | PKG

**EMBASSY** CEILING FAN



White Chrome

CF A 50 0045 WH GL	White Chrome	1250 mm	6100.00	2
CF A 50 0045 WC GL	White Copper	1250 mm	6100.00	2
CF A 50 0045 BR GL	Brown Copper	1250 mm	6250.00	2
CF A 50 0045 WG GL	Wengy Copper	1250 mm	7500.00	2



White Copper



Brown Copper



Wengy Copper

**EMBASSY** CEILING FAN



Matt White Copper

CF A 50 0047 MC GL	Matt White Copper	1250 mm	6100.00	2
CF A 50 0047 BC GL	Brown Chrome	1250 mm	6750.00	2



Brown Chrome

**ODYSSEY** PREMIER CEILING FAN



White Black

CF P 48 0069 WB MC	White Black	1200 mm	5000.00	2
CF P 48 0069 BG MC	Brown Gold	1200 mm	5000.00	2
CF P 48 0069 BW MC	Brown Wengy	1200 mm	5000.00	2



Brown Gold

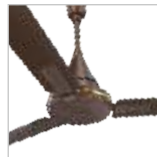

Brown Wengy

**ORISYS** PREMIER CEILING FAN



White Wengy

CF P 48 0075 WW MC	White Wengy	1200 mm	4499.00	2
CF P 48 0075 BW MC	Brown Wengy	1200 mm	4499.00	2
CF P 48 0075 BA MC	Brown Antique Copper	1200 mm	4499.00	2
CF P 48 0075 WA MC	White Antique Copper	1200 mm	4499.00	2



Brown Wengy



Brown Antique Copper



White Antique Copper



COMFORTING  
YOU 360°

Lustre has the royal Indian look for those with traditional preferences. It is designed to suit all kinds of customary interiors and is efficient and economical.

**Lustre**  
CEILING FAN

ITEM CODE | COLOUR | SWEEP | MRP ₹ | PKG

**ORISYS** POSH CEILING FAN



White Gun Metal

CF P 48 0066 WM MC	White Gun Metal	1200 mm	3800.00	2
CF P 48 0066 BM MC	Brown Gun Metal	1200 mm	3800.00	2
CF P 48 0066 WC MC	White Chrome	1200 mm	3800.00	2
CF P 48 0066 BA MC	Brown Antique Copper	1200 mm	3800.00	2
CF P 48 0066 BG MC	Brown Champagne Gold	1200 mm	3800.00	2



Brown Gun Metal



White Chrome



Brown Antique Copper



Brown Champagne Gold

**EXCEL 35** BLDC CEILING FAN



Matt Brown

CF B 48 0048 BR MT	Matt Brown	1200 mm	4700.00	2
CF B 48 0048 WH GL	White	1200 mm	4700.00	2
CF B 48 0048 IV GL	Ivory	1200 mm	4700.00	2



White



Ivory

**Lustre** CEILING FAN



Antique Brass

CF P 48 0013 BA EP	Antique Brass	1200 mm	6000.00	2
CF P 48 0013 CU EP	Antique Copper	1200 mm	6000.00	2
CF P 48 0013 BS EP	Brush Steel	1200 mm	6000.00	2



Antique Copper



Brush Steel

**Spencer** CEILING FAN



Antique Brass

CF P 48 0012 BA EP	Antique Brass	1200 mm	5250.00	2
CF P 48 0012 CU EP	Antique Copper	1200 mm	5250.00	2
CF P 48 0012 BS EP	Brush Steel	1200 mm	5250.00	2



Antique Copper



Brush Steel

ITEM CODE | COLOUR | SWEEP | MRP ₹ | PKG

### Spencer24 CEILING FAN



Antique Brass

CF P 24 0038 BA EP	Antique Brass	600 mm	3500.00	2
CF P 24 0038 CU EP	Antique Copper	600 mm	3500.00	2
CF P 24 0038 BS EP	Brush Steel	600 mm	3500.00	2



Antique Copper



Brush Steel

### Elegance CEILING FAN



Mettalic Gold

CF P 48 0073 GL MC	Mettalic Gold	1200 mm	3500.00	2
CF P 48 0073 WH MC	Pearl White	1200 mm	3500.00	2
CF P 48 0073 BR MC	Pearl Brown	1200 mm	3500.00	2



Pearl White



Pearl Brown

### Ferriö CEILING FAN



Matt Purple

CF P 48 0011 MP MT	Matt Purple	1200 mm	3200.00	2
CF P 48 0011 WH MC	Pearl White	1200 mm	3200.00	2
CF P 48 0011 GG MC	Glossy Gold	1200 mm	3200.00	2
CF P 48 0011 IV MC	Pearl Ivory	1200 mm	3200.00	2
CF P 48 0011 SR MC	Salmon Red	1200 mm	3200.00	2
CF P 36 0011 MP MT	Matt Purple	900 mm	2700.00	2
CF P 36 0011 WH MC	Pearl White	900 mm	2700.00	2
CF P 36 0011 GG MC	Glossy Gold	900 mm	2700.00	2
CF P 36 0011 IV MC	Pearl Ivory	900 mm	2700.00	2
CF P 36 0011 SR MC	Salmon Red	900 mm	2700.00	2



Pearl White



Glossy Gold



Pearl Ivory



Salmon Red

Unlimited freshness  
in all directions

WITH EXTRA  
COPPER

Elegance

ITEM CODE | COLOUR | SWEEP | MRP ₹ | PKG

**Ferrio** | DESIGNER SERIES | CEILING FAN



Legno White

CF P 48 0035 LW GL	Legno White	1200 mm	3600.00	2
CF P 48 0035 BI GL	Bianco Granito	1200 mm	3600.00	2
CF P 48 0035 MG GL	Midnight Granito	1200 mm	3600.00	2
CF P 48 0035 OG GL	Oro Granito	1200 mm	3600.00	2
CF P 48 0035 RJ GL	Rojo Granito	1200 mm	3600.00	2
CF P 48 0035 WD GL	Madera (Wood Finish)	1200 mm	4500.00	2



Bianco Granito



Midnight Granito



Oro Granito



Rojo Granito



Madera (Wood Finish)

**Nexa** CEILING FAN

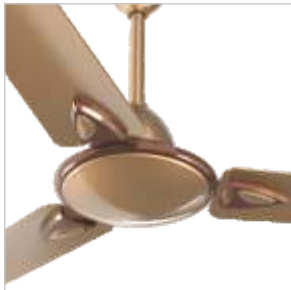

Rose Gold

CF E 48 0010 RG MC	Rose Gold	1200 mm	2650.00	4
CF E 48 0010 GL MC	Metallic Gold	1200 mm	2650.00	4
CF E 48 0010 SL MC	Metallic Silver	1200 mm	2650.00	4
CF E 48 0010 BR MC	Oreo Brown	1200 mm	2650.00	4



Metallic Gold



Metallic Silver



Oreo Brown

**Airwave** PREMIUM CEILING FAN

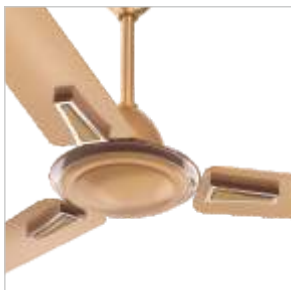

Rose Gold

CF P 48 0026 RG MC	Rose Gold	1200 mm	2525.00	4
CF P 48 0026 IV MC	Passion Ivory	1200 mm	2525.00	4
CF P 48 0026 RB MC	Blazing Red	1200 mm	2525.00	4
CF P 48 0026 BL MC	Midnight Blue	1200 mm	2525.00	4



Pearl Ivory



Blazing Red



Midnight Blue

WITH EXTRA COPPER

Sway in utmost tranquility

**Airwave** PREMIUM CEILING FAN



ITEM CODE | COLOUR | SWEEP | MRP ₹ | PKG

**Air wave** CEILING FAN



White

CF B 48 0003 WH GL	White	1200 mm	2250.00	4
CF B 48 0003 IV GL	Ivory	1200 mm	2250.00	4
CF B 48 0003 BR GL	Brown	1200 mm	2250.00	4



Ivory



Brown

**tOrrent** CEILING FAN



White

CF E 50 0004 WH GL	White	1250 mm	2750.00	4
CF E 50 0004 IV GL	Ivory	1250 mm	2750.00	4
CF E 50 0004 BR GL	Brown	1250 mm	2750.00	4



Ivory



Brown

**tOrrent metallic** CEILING FAN



Metallic Gold

CF P 50 0004 GL MC	Metallic Gold	1250 mm	3150.00	4
CF P 50 0004 BR MC	Oreo Brown	1250 mm	3150.00	4



Oreo Brown

**G-storm 400** CEILING FAN



Pearl Brown

CF E 48 0009 BR MC	Pearl Brown	1200 mm	2750.00	4
CF E 48 0009 WH MC	Pearl White	1200 mm	2750.00	4
CF E 48 0009 GL MC	Pearl Gold	1200 mm	2750.00	4
CF E 48 0009 IV MC	Pearl Ivory	1200 mm	2750.00	4



Pearl White



Pearl Gold



Pearl Ivory

ITEM CODE | COLOUR | SWEEP | MRP ₹ | PKG

**G>AIR** CEILING FAN



White

CF E 48 0001 WH GL	White	1200 mm	2450.00	4
CF E 48 0001 IV GL	Ivory	1200 mm	2450.00	4
CF E 48 0001 BR GL	Brown	1200 mm	2450.00	4
CF E 48 0001 BR MT	Matt Brown	1200 mm	2450.00	4



Ivory



Brown



Matt Brown

**AIR9** CEILING FAN



White

CF B 48 0006 WH GL	White	1200 mm	2075.00	4
CF B 48 0006 IV GL	Ivory	1200 mm	2075.00	4
CF B 48 0006 BR GL	Brown	1200 mm	2075.00	4
CF B 48 0006 BC GL	Black Coffee	1200 mm	2075.00	4



Ivory



Brown



Black Coffee

**AIR9+** CEILING FAN



White

CF B 48 0032 WH GL	White	1200 mm	2500.00	4
CF B 48 0032 IV GL	Ivory	1200 mm	2500.00	4
CF B 48 0032 BR GL	Brown	1200 mm	2500.00	4
CF B 48 0032 BC GL	Black Coffee	1200 mm	2600.00	4
CF B 56 0032 WH GL	White	1400 mm	2600.00	4
CF B 56 0032 IV GL	Ivory	1400 mm	2600.00	4
CF B 56 0032 BR GL	Brown	1400 mm	2600.00	4
CF B 36 0032 WH GL	White	900 mm	2250.00	4
CF B 36 0032 IV GL	Ivory	900 mm	2250.00	4
CF B 36 0032 BR GL	Brown	900 mm	2250.00	4
CF B 36 0032 BC GL	Black Coffee	900 mm	2300.00	4
CF B 24 0032 WH GL	White	600 mm	2250.00	4
CF B 24 0032 IV GL	Ivory	600 mm	2250.00	4
CF B 24 0032 BR GL	Brown	600 mm	2250.00	4
CF B 24 0032 BC GL	Black Coffee	600 mm	2300.00	4



Ivory



Brown



Black Coffee

ITEM CODE | COLOUR | SWEEP | MRP ₹ | PKG

**AIR9+DECO** CEILING FAN



White

CF B 48 0033 WH GL	White	1200 mm	2300.00	4
CF B 48 0033 IV GL	Ivory	1200 mm	2300.00	4
CF B 48 0033 BR GL	Brown	1200 mm	2300.00	4



Ivory



Brown

**AirBreeze 400** CEILING FAN



White

CF B 48 0063 WH GL	White	1200 mm	2075.00	4
CF B 48 0063 IV GL	Ivory	1200 mm	2075.00	4
CF B 48 0063 BR GL	Brown	1200 mm	2075.00	4
CF B 48 0063 TC GL	Tangy Coffee	1200 mm	2075.00	4



Ivory



Brown



Tangy Coffee

**AirDeco 400** CEILING FAN



Smokey Grey

CF B 48 0064 SG GL	Smokey Grey	1200 mm	2350.00	4
CF B 48 0064 BR GL	PM Brown	1200 mm	2350.00	4
CF B 48 0064 GY GL	PM Grey	1200 mm	2350.00	4
CF B 48 0064 GO GL	PM Gold	1200 mm	2350.00	4



PM Brown



PM Grey



PM Gold

**GxBreeze Deco** CEILING FAN



White

CF B 48 0036 WH GL	White	1200 mm	2250.00	4
CF B 48 0036 IV GL	Ivory	1200 mm	2250.00	4
CF B 48 0036 BR GL	Brown	1200 mm	2250.00	4



Ivory

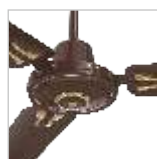

Brown

ITEM CODE | COLOUR | SWEEP | MRP ₹ | PKG

**Breeze** CEILING FAN



Brown

CF B 48 0008 BR GL	Brown	1200 mm	2075.00	4
CF B 48 0008 IV GL	Ivory	1200 mm	2075.00	4
CF B 48 0008 WH GL	White	1200 mm	2075.00	4
CF B 48 0008 BR GL	Black Coffee	1200 mm	2075.00	4
CF B 56 0008 WH GL	White	1400 mm	2200.00	3
CF B 56 0008 IV GL	Ivory	1400 mm	2200.00	3
CF B 56 0008 BR GL	Brown	1400 mm	2200.00	3



Ivory



White



Black Coffee

**Speedo** CEILING FAN



Ivory

CF E 24 0005 IV GL	Ivory	600 mm	2250.00	4
CF E 24 0005 WH GL	White	600 mm	2250.00	4
CF E 24 0005 BR GL	Brown	600 mm	2250.00	4



White



Brown

**Speedo deco** CEILING FAN



Pearl White

CF E 24 0037 WH MC	Pearl White	600 mm	2500.00	4
CF E 24 0037 BR MC	Oreo Brown	600 mm	2500.00	4
CF E 24 0037 RG MC	Rose Gold	600 mm	2500.00	4
CF E 24 0037 GG MC	Glossy Gold	600 mm	2500.00	4



Oreo Brown



Rose Gold



Glossy Gold

Delivering good air  
exceedingly well

WITH EXTRA  
COPPER

**Speedo**  
CEILING FAN **deco**

ITEM CODE | COLOUR | SWEEP | MRP ₹ | PKG

**SONIC 650** CEILING FAN



Ivory

CF B 36 0044 IV GL	Ivory	900 mm	2500.00	4
CF B 36 0044 WH GL	White	900 mm	2500.00	4
CF B 36 0044 BR GL	Brown	900 mm	2500.00	4



White



Brown

VENTILATION / EXHAUST FANS

**ECOAIR** VENTILATING FAN



White

VF B 06 0014 WH GL	White	150 mm	1425.00	6
VF B 06 0014 IV GL	Ivory	150 mm	1425.00	6
VF B 06 0014 BK GL	Black	150 mm	1425.00	6
VF B 06 0014 BR GL	Brown	150 mm	1425.00	6
VF B 08 0014 WH GL	White	200 mm	1575.00	6
VF B 08 0014 IV GL	Ivory	200 mm	1575.00	6
VF B 08 0014 BK GL	Black	200 mm	1575.00	6
VF B 08 0014 BR GL	Brown	200 mm	1575.00	6
VF B 10 0014 WH GL	White	250 mm	1675.00	4
VF B 10 0014 IV GL	Ivory	250 mm	1675.00	4
VF B 10 0014 BK GL	Black	250 mm	1675.00	4
VF B 10 0014 BR GL	Brown	250 mm	1675.00	4



Ivory



Black



Brown

**ECOAIR HS** VENTILATING FAN



White

VF B 06 0029 WH GL	White	150 mm	1600.00	4
VF B 06 0029 IV GL	Ivory	150 mm	1600.00	4
VF B 06 0029 BK GL	Black	150 mm	1600.00	4
VF B 06 0029 BR GL	Brown	150 mm	1600.00	4
VF B 08 0029 WH GL	White	200 mm	1700.00	4
VF B 08 0029 IV GL	Ivory	200 mm	1700.00	4
VF B 08 0029 BK GL	Black	200 mm	1700.00	4
VF B 08 0029 BR GL	Brown	200 mm	1700.00	4



Ivory



Black



Brown

ITEM CODE | COLOUR | SWEEP | MRP ₹ | PKG

**ECOAIR<sup>SP</sup>** VENTILATING FAN



White

VF B 06 0031 WH GL	White	150 mm	1500.00	6
VF B 08 0031 WH GL	White	200 mm	1625.00	6

**ECOAIR<sup>SECURE</sup>** VENTILATING FAN

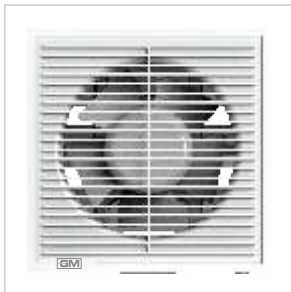

White

VF I 08 0048 WH GL	White	200 mm	1675.00	6
VF I 08 0048 WDMT	Wooden Finish	200 mm	2100.00	6



Wooden Finish

**UNI<sup>AI</sup>IR** VENTILATING FAN



White

VF E 06 0018 WH GL	White	150 mm	1350.00	6
VF E 06 0018 IV GL	Ivory	150 mm	1350.00	6
VF E 06 0018 BK GL	Black	150 mm	1350.00	6



Ivory



Black

**FLO<sup>AI</sup>IR** VENTILATING FAN

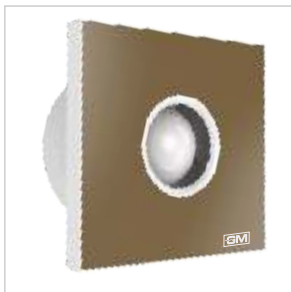

Gold

VF E 06 0019 GL SE	Gold	150 mm	1275.00	6
VF E 06 0019 SL SE	Silver	150 mm	1275.00	6
VF E 06 0019 RB SE	Blazing Red	150 mm	1275.00	6
VF E 06 0019 BK SE	Pearl Black	150 mm	1275.00	6



Silver



Blazing Red

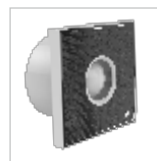

Pearl Black

ITEM CODE | COLOUR | SWEEP | MRP ₹ | PKG

**FRESHAIR** VENTILATING FAN



Silver

VF E 04 0016 WH GL	White	100 mm	1125.00	6
VF E 04 0016 IV GL	Ivory	100 mm	1125.00	6
VF E 04 0016 BK GL	Black	100 mm	1125.00	6
VF E 04 0016 BR GL	Brown	100 mm	1125.00	6
VF E 06 0016 WH GL	White	150 mm	1275.00	6
VF E 06 0016 IV GL	Ivory	150 mm	1275.00	6
VF E 06 0016 BK GL	Black	150 mm	1275.00	6
VF E 06 0016 BR GL	Brown	150 mm	1275.00	6



Ivory



Black



Brown

**Afresh** VENTILATING FAN



White

VF E 04 0017 WH GL	White	100 mm	1450.00	6
VF E 04 0017 IV GL	Ivory	100 mm	1450.00	6
VF E 04 0017 SS MC	Steel Finish	100 mm	1525.00	6
VF E 04 0017 BR GL	Brown	100 mm	1450.00	6
VF E 06 0017 WH GL	White	150 mm	1500.00	6
VF E 06 0017 IV GL	Ivory	150 mm	1500.00	6
VF E 06 0017 SS MC	Steel Finish	150 mm	1575.00	6
VF E 06 0017 WD MT	Wood Finish	150 mm	1575.00	6
VF E 0600 17 BR GL	Brown	150 mm	1500.00	6



Ivory



Steel Finish



Wood Finish



Brown

**Aero** VENTILATING FAN



White

VF I 06 0030 WH GL	White	150 mm	1700.00	12
VF I 06 0030 BK GL	Black	150 mm	1700.00	12
VF I 06 0030 SL GL	Silver	150 mm	1700.00	12
VF I 08 0030 WH GL	White	200 mm	1850.00	12



Black



Silver

ITEM CODE | COLOUR | SWEEP | MRP ₹ | PKG

**Fresho** VENTILATING FAN



White

VF I 04 0031 WH GL	White	100 mm	1200.00	12
VF I 06 0031 WH GL	White	150 mm	1450.00	12

**Fluro** VENTILATING FAN



White

VF I 04 0032 WH GL	White	100 mm	1900.00	12
VF I 06 0032 WH GL	White	150 mm	2400.00	12

**Ventilo** VENTILATING FAN



Black

VF I 06 0033 BK GL	Black	150 mm	1650.00	12
VF I 06 0033 WH GL	White	150 mm	1650.00	12



White

**Afresho** VENTILATING FAN



Steel Finish

VF I 06 0042 IV GL	Ivory	150 mm	1700.00	20
VF I 06 0042 SS MC	Steel Finish	150 mm	2300.00	20



Ivory



ITEM CODE | COLOUR | SWEEP | MRP ₹ | PKG

**XENIX HS & XENIX** VENTILATING FAN



Grey Matt / Gold Black

VF B 06 0015 GY MT	Grey Matt	150 mm	1950.00	4
VF B 09 0015 GY MT	Grey Matt	225 mm	1850.00	4
VF B 12 0015 GY MT	Grey Matt	300 mm	2000.00	4
VF B 06 0055 GB GL	Gold Black	150 mm	1950.00	6
VF B 09 0055 GB GL	Gold Black	225 mm	1850.00	4
VF B 12 0055 GB GL	Gold Black	300 mm	2000.00	4



Grey Matt / Gold Black



Grey Matt / Gold Black

**XENIX PLUS HS & XENIX ULTRA HS** VENTILATING FAN



Gold Black

VF B 09 0020 GY GL	Gold Black	225 mm	1825.00	4
VF B 09 0066 GB GL	Gold Black	230 mm	1825.00	4

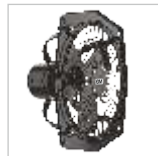

Gold Black

**XENIX 2 WAY** VENTILATING FAN



Gold Black

VF B 09 0042 GB GL	Gold Black	230 mm	2200.00	4
--------------------	------------	--------	---------	---

**XENIX PRO** VENTILATING FAN



Gold Black

VF P 09 0041 GB GL	Gold Black	230 mm	1900.00	4
VF P 12 0041 GB GL	Gold Black	300 mm	2275.00	4



Scan the QR code to watch the video

Freshness in more ways than one

**XENIX PRO**  
VENTILATING FAN

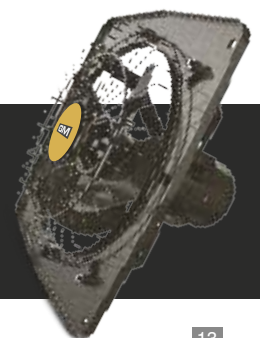

ITEM CODE | COLOUR | SWEEP | MRP ₹ | PKG

**Zephyr** PEDESTAL FAN

PF I 12 0035 WH GL	White	300 mm	12000.00	2
--------------------	-------	--------	----------	---



White

**MAESTRO360°** PEDESTAL FAN

PF I 16 0029 WH GL	White	400 mm	11000.00	1
PF I 16 0029 BK GL	Black	400 mm	11000.00	1



White



Black

**MystiQue** PEDESTAL FAN

PF I 16 0074 WH GL	White	400 mm	7100.00	1
--------------------	-------	--------	---------	---



White

**AirMate** PEDESTAL FAN

PF I 09 0050 WH GL	White	230 mm	8990.00	1
--------------------	-------	--------	---------	---



White

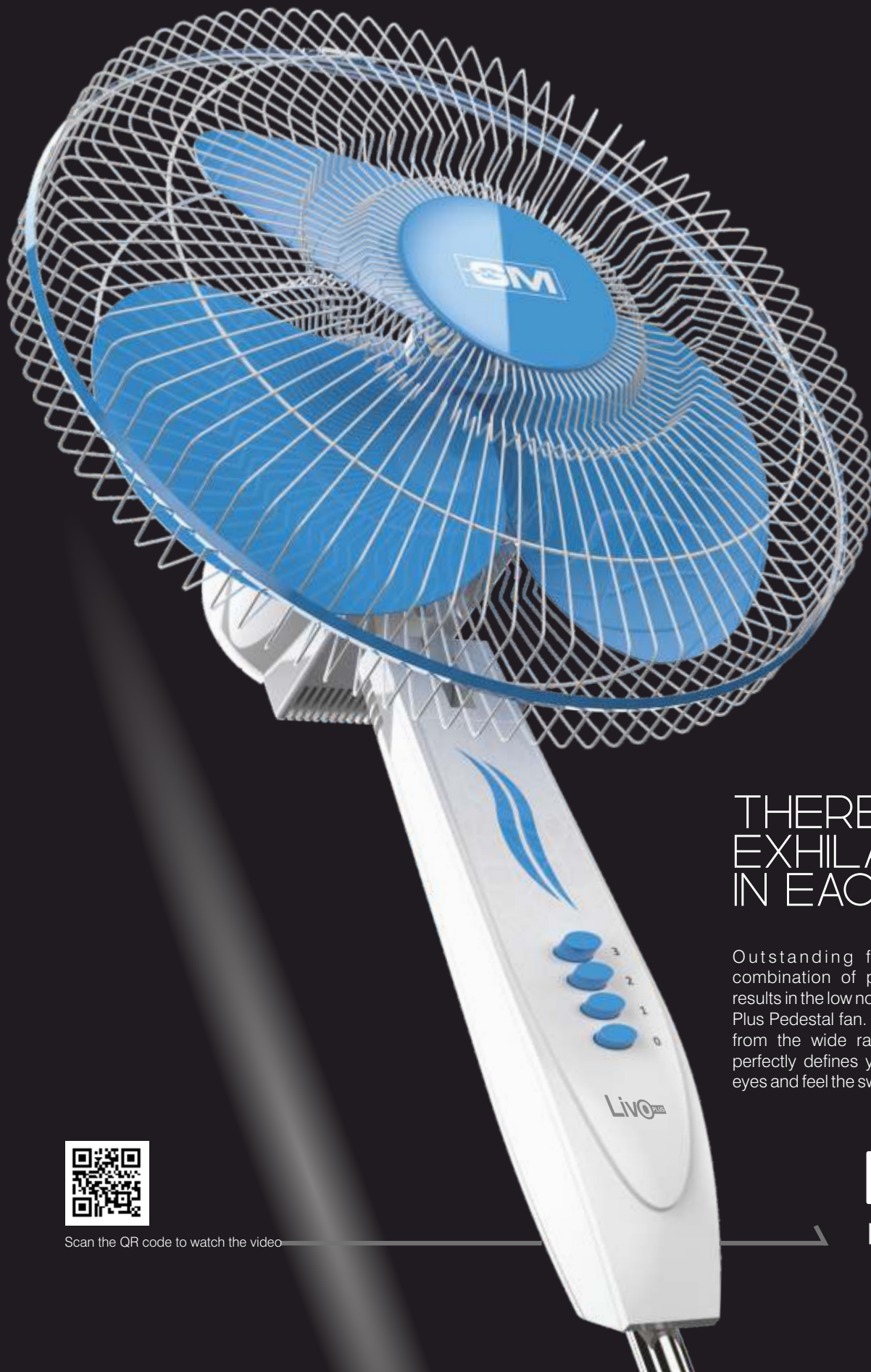

## THERE'S EXHILARATION IN EACH SWAY

Outstanding functioning is the combination of powerful motor which results in the low noise operation of the Livo Plus Pedestal fan. You can always choose from the wide range of colours which perfectly defines your space. Close your eyes and feel the sway!



Scan the QR code to watch the video

**Livo** PLUS  
PEDESTAL FAN

ITEM CODE | COLOUR | SWEEP | MRP ₹ | PKG

**LivO PLUS** PEDESTAL FAN



Yellow Black

PF B 16 0025 YL GL	Yellow Black	400 mm	3200.00	3
PF B 16 0025 WH GL	White	400 mm	3200.00	3
PF B 16 0025 GY GL	Grey	400 mm	3200.00	3
PF B 16 0025 BG GL	Burgundy	400 mm	3200.00	3
PF B 16 0025 YW GL	Yellow	400 mm	3200.00	3
PF B 16 0025 BL GL	Blue	400 mm	3200.00	3
PF B 16 0025 RB GL	Red-Black	400 mm	3200.00	3
PF B 16 0025 FB GL	Fluorescent Blue	400 mm	3200.00	3



**LivO SP** PEDESTAL FAN



Blue

PF I 16 0050 BL GL	Blue	400 mm	2900.00	1
PF I 16 0050 WH GL	White	400 mm	2900.00	1
PF I 16 0050 BG GL	Burgundy	400 mm	2900.00	1



**bolt** PEDESTAL FAN



White

PF B 16 0024 WH GL	White	400 mm	3350.00	2
PF B 16 0024 BL GL	Blue	400 mm	3350.00	2
PF B 16 0024 BG GL	Burgundy	400 mm	3350.00	2
PF B 16 0024 WH GL	Grey	400 mm	3350.00	2
PF B 16 0024 BL GL	Fluorescent Blue	400 mm	3350.00	2



ITEM CODE | COLOUR | SWEEP | MRP ₹ | PKG

**bolt** PLUS PEDESTAL FAN

PF B 16 0027 BK GL	Black	400 mm	2400.00	3
--------------------	-------	--------	---------	---



Black

**AirBURST** PREMIUM PEDESTAL FAN

PF I 18 0040 CR GL	Chrome	450 mm	6000.00	1
--------------------	--------	--------	---------	---



Chrome

**AirBURST** PREMIUM - ABS PEDESTAL FAN

PF I 18 0071 OR GL	Orange	450 mm	5350.00	1
--------------------	--------	--------	---------	---



Chrome

**AirBURST** PEDESTAL FAN

PF B 18 0030 CR GL	Chrome	450 mm	4950.00	2
--------------------	--------	--------	---------	---



Chrome



Black

ITEM CODE | COLOUR | SWEEP | MRP ₹ | PKG

**Tempest** FARRATA PEDESTAL FAN

PF B 20 0034 BK GL	Black	500 mm	5100.00	2
PF B 20 0054 BK GL	Black	500 mm	5100.00	2
PF B 20 0046 BK GL	Black	500 mm	5100.00	2



Black

**AirBlast** PEDESTAL FAN

PF B 16 0022 BK GL	Black	400 mm	3600.00	2
PF B 16 0022 YL GL	Yellow	400 mm	3600.00	2
PF B 16 0022 BG GL	Burgundy	400 mm	3600.00	2



Yellow

Burgundy



Black

**Airmark** PEDESTAL FAN

PF B 18 0043 BK GL	Black	450 mm	5350.00	1
PF B 18 0043 SL GL	Silver	450 mm	5350.00	1



Silver



White

ITEM CODE | COLOUR | SWEEP | MRP ₹ | PKG

**LivO PLUS** TABLE FAN

TF B 16 0025 WH GL	White	400 mm	2350.00	3
TF B 16 0025 GY GL	Grey	400 mm	2350.00	3
TF B 16 0025 BG GL	Burgundy	400 mm	2350.00	3
TF B 16 0025 YL GL	Yellow	400 mm	2350.00	3
TF B 16 0025 GR GL	Blue	400 mm	2350.00	3
TF B 16 0025 FB GL	Fluorescent Blue	400 mm	2350.00	3



Grey



Burgundy



Yellow



Blue



Fluorescent Blue



Blue

**LivO SP** TABLE FAN

TF I 16 0050 WH GL	White	400 mm	2400.00	1
TF I 16 0050 BL GL	Blue	400 mm	2400.00	1
TF I 16 0050 BG GL	Burgundy	400 mm	2400.00	1



Burgundy



White

**bolt** TABLE FAN

TF B 16 0024 WH GL	White	400 mm	2750.00	3
TF B 16 0024 BL GL	Blue	400 mm	2750.00	3
TF B 16 0024 BG GL	Burgundy	400 mm	2750.00	3
TF B 16 0024 GY GL	Grey	400 mm	2750.00	3
TF B 16 0024 FB GL	Fluorescent Blue	400 mm	2750.00	3



Blue



Burgundy



Grey



Fluorescent Blue

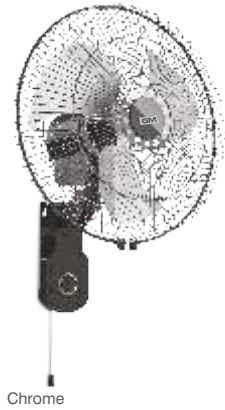

ITEM CODE | COLOUR | SWEEP | MRP ₹ | PKG

**AirBURST** WALL FAN

WF B 18 0030 CR GL	Chrome	450 mm	4900.00	2
--------------------	--------	--------	---------	---

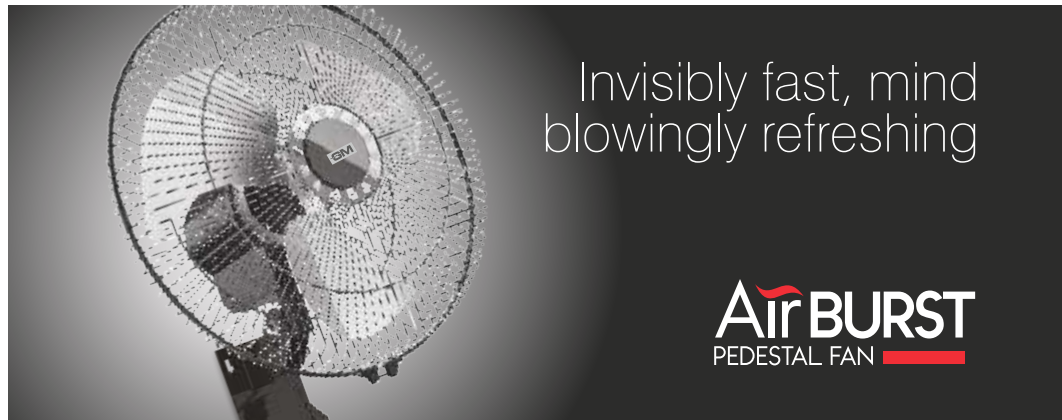

**LivO PLUS** WALL FAN

WF B 16 0025 YL GL	Yellow	400 mm	2400.00	3
WF B 16 0025 WH GL	White	400 mm	2400.00	3
WF B 16 0025 BG GL	Burgundy	400 mm	2400.00	3
WF B 16 0025 FB GL	Fluorescent Blue	400 mm	2400.00	3
WF B 16 0025 BL GL	Blue	400 mm	2400.00	3
WF B 16 0025 GY GL	Grey	400 mm	2400.00	3
WF B 16 0025 BK GL	Black	400 mm	2400.00	3

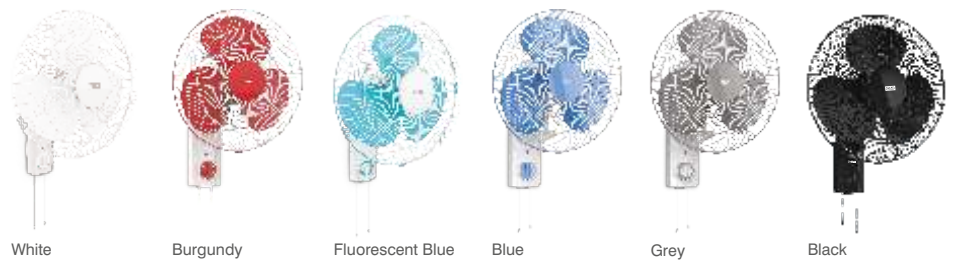

**LivO SP** WALL FAN

WF I 16 0050 WH GL	White	400 mm	2600.00	1
WF I 16 0050 BL GL	Blue	400 mm	2600.00	1
WF I 16 0050 BG GL	Burgundy	400 mm	2600.00	1





ITEM CODE | COLOUR | SWEEP | MRP ₹ | PKG

**bolt** WALL FAN



White

WF B 16 0024 WH GL	White	400 mm	2850.00	3
WF B 16 0024 BL GL	Blue	400 mm	2850.00	3
WF B 16 0024 BG GL	Burgundy	400 mm	2850.00	3
WF B 16 0024 GY GL	Grey	400 mm	2850.00	3
WF B 16 0024 FB GL	Fluorescent Blue	400 mm	2850.00	3
WF B 12 0024 WH GL	White	300 mm	2550.00	3
WF B 12 0024 BL GL	Blue	300 mm	2550.00	3
WF B 12 0024 BG GL	Burgundy	300 mm	2550.00	3



Blue



Burgundy



Grey



Fluorescent Blue

PERSONAL FANS

**blizzard** MULTIPURPOSE FAN



True Blue

PE B 09 0039 BL GL	True Blue	230 mm	2100.00	4
PE B 09 0039 RD GL	Signal Red	230 mm	2100.00	4
PE B 09 0039 BY GL	Blacky Yellow	230 mm	2100.00	4



Single Red



Blacky Yellow

**HANDY AIR** PERSONAL FAN



White

PE I 06 0049 WH GL	White	150 mm	1475.00	24
--------------------	-------	--------	---------	----

ITEM CODE | COLOUR | SWEEP | MRP ₹ | PKG



Grey

**AIR** MOBILE MINI TABLE FAN

PE I 06 0052 GY GL	Grey	150 mm	2750.00	8
--------------------	------	--------	---------	---



White

**Air** PERSONAL FAN

PE I 06 0054 WH GL	White	150 mm	3600.00	10
--------------------	-------	--------	---------	----



White

**Air 180** PERSONAL FAN

PE I 06 0055 WH GL	White	150 mm	5000.00	10
--------------------	-------	--------	---------	----



White

**CabiAir** CABIN FAN

PE B 12 0053 WH GL	White	300 mm	2350.00	3
--------------------	-------	--------	---------	---



White

**AIRSPIN** ROTATING CABIN FAN

PE B 16 0074 WH GL	White	400 mm	3400.00	1
--------------------	-------	--------	---------	---

# AIRY INNOVATION ON THE MOVE

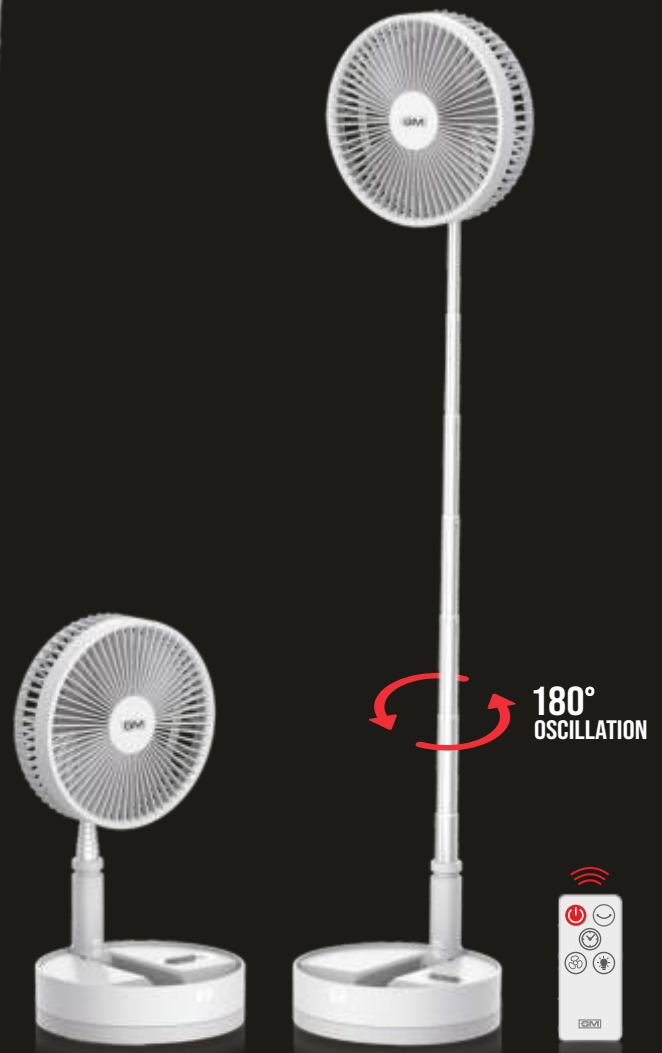

Uniqueness is magic and no spell can go wrong when it comes to Air 180. It comprises features like 4-speed operation, adjustable height, working time of 4-18 hours, detachable front guard for easy cleaning and what not! Operate it with a stylish remote and mark the actual saying of comfort at your fingertips!

Scan the QR code to watch the video

**Air 180**  
PERSONAL FAN

PERSONAL FANS



White

ITEM CODE	COLOUR	SWEEP	MRP ₹	PKG
<b>DYNAMO</b> MULTIPURPOSE FAN				
PE B 12 0066 BL GL	BLUE	300 mm	2100.00	4

INDUSTRIAL FANS



Gold Black

<b>Dynamite</b> PEDESTAL FAN				
AIR CIRCULATOR				
PF B 18 0051 GB GL	Gold Black	450 mm	7500.00	1
PF B 24 0051 GB GL	Gold Black	600 mm	9500.00	1
PF B 30 0051 GB GL	Gold Black	750 mm	10500.00	1



Gold Black

<b>Dynamite</b> WALL FAN				
AIR CIRCULATOR				
WF B 18 0051 GB GL	Gold Black	450 mm	6500.00	1
WF B 24 0051 GB GL	Gold Black	600 mm	7980.00	1
WF B 30 0051 GB GL	Gold Black	750 mm	9500.00	1



Gold Black

<b>XENIX</b> <small>HEAVY DUTY</small> EXHAUST FAN				
VF B 12 0049 GB GL	Gold Black	300 mm	3500.00	1
VF B 15 0049 GB GL	Gold Black	380 mm	4000.00	1
VF B 18 0049 GB GL	Gold Black	450 mm	6000.00	1
VF B 24 0049 GB GL	Gold Black	600 mm	9975.00	1

# FOR THE MIGHTY WIND



Scan the QR code to watch the video

The Dynamite industrial fan with rugged motor and balanced blades release an air of freshness in strenuous working conditions, and create a rejuvenating ambience. It not only makes one feel energetic, but also makes the environment pleasant.

**Dynamite**  
AIR CIRCULATOR

# TECHNICAL SPECIFICATIONS



MODEL NAME	SWEEP (IN MM)	WATTAGE (WATTS)	SPEED (IN RPM)	AIR DELIVERY (IN CU MTR/MIN)
------------	------------------	--------------------	-------------------	---------------------------------

## CEILING FANS

ODYSSEY	1200 mm	75	380	230
ORISYS	1200 mm	75	385	230
EMBASSY	1250 mm	75	310	240
EXCEL 35 BLDC	1200 mm	38	380	230
Lustre	1200 mm	75	375	215
Spencer	1200 mm	75	375	215
Spencer 24	600 mm	70	850	210
Ferrio	1200 mm	80	380	220
Ferrio	900 mm	60	420	125
Ferrio Designer Series	1200 mm	80	380	220
Nexa	1200 mm	75	380	220
Airwave Premium	1200 mm	70	380	215
G-Storm 400	1200 mm	75	400	240
Torrent	1250 mm	70	370	255
G Air	1200 mm	75	380	230
G Air	1400 mm	80	280	270
Airwave	1200 mm	75	395	215
Airwave	1400 mm	82	290	245
G-Breeze	1200 mm	70	400	210
G-Breeze	1400 mm	82	290	245
G-Breeze Deco	1200 mm	82	400	210
Speedo	600 mm	68	850	110
Speedo Deco	600 mm	68	850	110
AIR9+	600 mm	68	850	110
AIR9+	900 mm	62	420	140
AIR9+	1200 mm	75	400	210
AIR9+	1400 mm	72	290	245
AIR9+ Deco	1200 mm	75	400	210
SONIC 650	900 mm	70	650	150

MODEL NAME	SWEEP (IN MM)	WATTAGE (WATTS)	SPEED (IN RPM)	AIR DELIVERY (IN CU MTR/HOUR)
------------	------------------	--------------------	-------------------	----------------------------------

## VENTILATION/EXHAUST FANS

Eco Air	150 mm	29	1320	300
Eco Air	200 mm	32	1320	550
Eco Air	250 mm	36	1200	750
Eco Air HS	150 mm	32	2700	431
Eco Air HS	200 mm	49	2345	798
Eco Air SP	150 mm	25	1300	275
Eco Air SP	200 mm	30	1300	450
Eco Air Secure	200 mm	32	1320	550
Xenix HS	150 mm	52	2650	600
Xenix	225 mm	45	1380	550
Xenix	300 mm	60	1380	1200
Xenix Plus HS	225 mm	55	2450	600
Xenix 2 Way	230 mm	75	2300	600
Xenix Pro	230 mm	45	1400	550
Xenix Pro	300 mm	70	1400	1400

# TECHNICAL SPECIFICATIONS



MODEL NAME	SWEEP (IN MM)	WATTAGE (WATTS)	SPEED (IN RPM)	AIR DELIVERY (IN CU MTR/HOUR)
------------	---------------	-----------------	----------------	-------------------------------

## VENTILATION/EXHAUST FANS

Fresh Air	100 mm	22	2650	80
Fresh Air	150 mm	25	2250	240
Afresh	150 mm	25	2250	240
Uniair	150 mm	25	2250	240
Flo Air	150 mm	25	2250	240
Aero	150 mm	17	1750	138
Aero	200 mm	18	1480	222
Fresho	100 mm	12	2300	108
Fresho	150 mm	20	1650	150
Fluro	150 mm	18	1400	160
Ventilo	150 mm	17	1750	132
Afresho	150 mm	25	1800	150

MODEL NAME	SWEEP (IN MM)	WATTAGE (WATTS)	SPEED (IN RPM)	AIR DELIVERY (IN CU MTR/MIN)
------------	---------------	-----------------	----------------	------------------------------

## PEDESTAL/WALL/TABLE FANS

Zephyr Pedestal Fan	300 mm	20	1100	24
Maestro 360° Pedestal Fan	400 mm	65	1200	60
Mystique Pedestal Fan	400 mm	33	900	70
AirMate Pedestal Fan	230 mm	45	1800	60
Livo Plus Pedestal Fan	400 mm	60	1400	73
Livo SP Pedestal Fan	400 mm	55	1400	75
Bolt Pedestal Fan	400 mm	130	2050	90
Bolt Plus Pedestal Fan	400 mm	110	2100	90
AirBurst Premium Pedestal Fan	450 mm	120	1400	115
AirBurst Premium ABS Pedestal Fan	450 mm	120	1400	115
AirBurst Pedestal Fan	450 mm	90	1400	110
Tempest Farrata Pedestal Fan	500 mm	150	1400	115
AirBlast Pedestal Fan	400 mm	120	2300	105
AirMark Pedestal Fan	450 mm	100	1400	115
Livo Plus Table Fan	400 mm	60	1400	73
Livo SP Table Fan	400 mm	55	1400	75
Bolt Table Fan	400 mm	130	2050	90
AirBurst Wall Fan	450 mm	90	1400	110
Livo Plus Wall Fan	400 mm	55	1400	75
Livo SP Wall Fan	300 mm	130	2055	57
Bolt Wall Fan	400 mm	88	2200	90

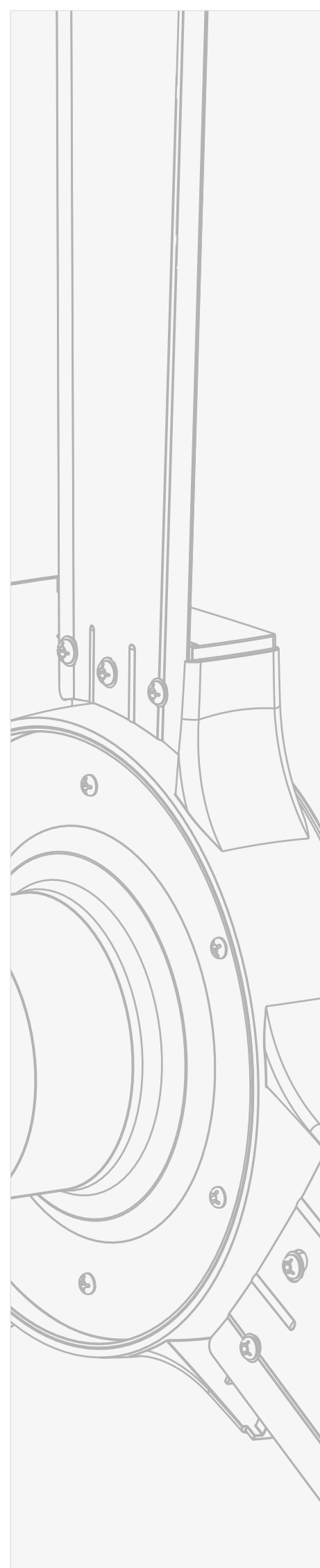

# TECHNICAL SPECIFICATIONS

MODEL NAME	SWEEP (IN MM)	WATTAGE (WATTS)	SPEED (IN RPM)	AIR DELIVERY (IN CU MTR/MIN)
------------	---------------	-----------------	----------------	------------------------------

## PERSONAL FANS

Blizzard Multipurpose Fan	230 mm	46	2600	25
Handy Air	150 mm	DC 5V	2700	23
Air Mobile	150 mm	DC 5V	2500	24
Air	150 mm	DC 5V	1900	24
Air 180	150 mm	DC 5V	2500	24
CabiAir	300 mm	85	2200	60
AirSpin	400 mm	60	1350	60
Dynamo	300 mm	70	2500	55

MODEL NAME	SWEEP (IN MM)	WATTAGE (WATTS)	SPEED (IN RPM)	AIR DELIVERY (IN CU MTR/HOUR)
------------	---------------	-----------------	----------------	-------------------------------

## INDUSTRIAL FANS

Dynamite (Pedestal & Wall)	750	150	1400	22200
	600	150	1400	16000
	450	150	1400	7500
Xenix Heavy Duty Exhaust	600	460	920	9400
	450	250	1350	3900
	380	150	1400	2000
	300	55	1400	1145

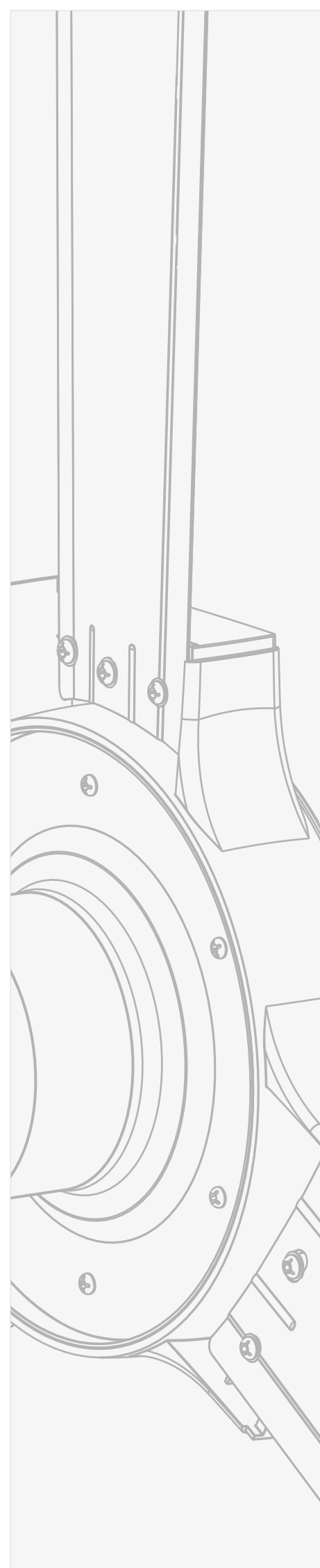





Delivering  
**good air**



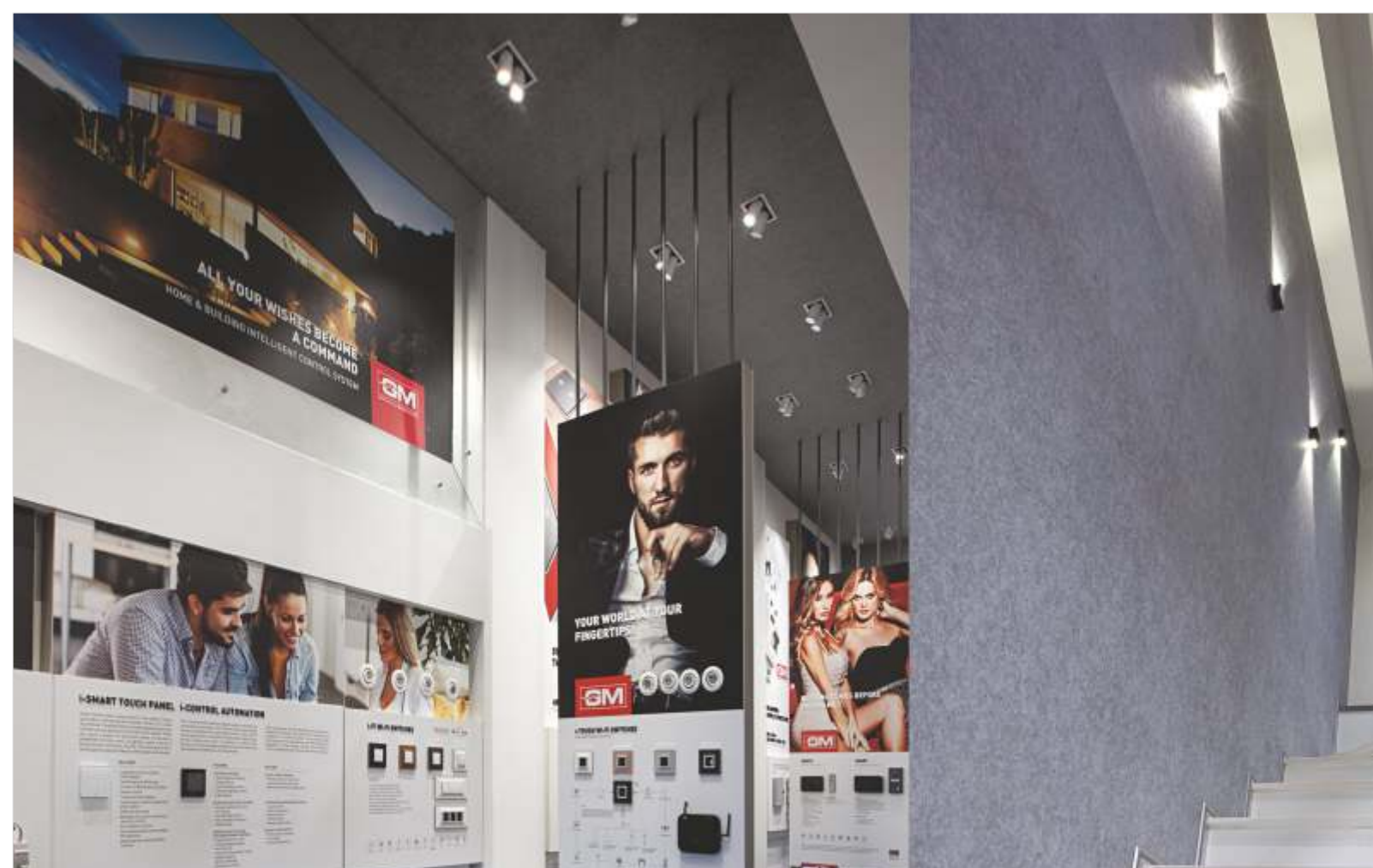

exclusive  
experience  
centres



■ INDIA

**Mumbai**

G-6, Laxmi Industrial Estate,  
Opp. Laxmi Chhaya Hotel,  
New Link Road, Andheri (W)  
Mumbai - 400 053, Maharashtra.  
Email: info@gmmodular.com  
Contact: +91 8879918221

Shop No.1 Plot No. 151/153,  
Bhabha Building, Lohar Chawl,  
Mumbai - 400 002, Maharashtra.  
Email: info@gmmodular.com  
Contact: 022 2206 6545

**Bengaluru**

460/20/1, 30th Cross,  
8th B Main Road,  
4th Block, Beside Jain Temple,  
Jayanagar  
Bengaluru - 560 011, Karnataka.  
Email: info@gmmodular.com  
Contact: 080 4097 1188

**Belagavi**

Shop No. 571,  
Bhati Tower, Patil Galli,  
Belagavi - 590 001, Karnataka.  
Email: info@gmmodular.com  
Contact: +91 99453 33107

**Hyderabad**

No. 5-5-84/87, Shop No. 2&3,  
Kalpakunj Apartment, Jambaug,  
Hyderabad - 500 012, Telangana.  
Email: info@gmmodular.com  
Contact: 040 2473 4545

**Vijayawada**

K. S. Vyas Traffic Control Complex,  
Opp. Indira Gandhi Municipal Stadium,  
MG Road, Vijayawada - 520 010,  
Andhra Pradesh.  
Email:  
showroom.vijayawada@gmmodular.com  
Contact: +91 86624 99945  
+91 74166 14545

**Jalore**

Near Kanchangiri Jain Temple,  
Opp. Haridev Joshi Circle,  
Bagoda Road,  
Jalore - 343 001, Rajasthan.  
Email: info@gmmodular.com  
Contact: +91 79769 79283,  
02973-222288.

■ UAE

**Dubai**

GMM Electricals LLC  
Warehouse # 38, Al Tayer Warehouse,  
Al Quoz Industrial Area # 3, Al Quoz Industrial Area,  
Dubai Landmark: Behind NICO International  
Contact: +971 4 354 4036, +971 4 251 8008

■ SPAIN

**Madrid**

GMM Electric Europe S.A.  
Calle Valdeon 28, 28947 Fuenlabrada.  
Madrid.  
Contact: +34 677 62 09 45

Concept, Design, Product Visualization GM Modular Pvt. Ltd.

Printing Mumbai, India. Possible colour variations in product images in the catalogue.

We reserve the right to make technical changes to the products as well as amendments to the content of this document at any time without prior notice. The agreed properties are definitive for any orders placed.

GM Modular Pvt. Ltd. shall not be for any consequences arising from the errors or incomplete information in this document. We reserve all rights in this document and in the subject matter and illustrations contained therein.

Reproduction, transfer to third parties or processing of the content including sections thereof, is not permitted without prior expressed written permission from GM Modular Pvt. Ltd.

Copyright © 2019 GM All rights reserved.



## Giving you our best

GM has been extending innovative technology and luxury experiences for more than two decades. Our years of experience and expertise provide invaluable benefits to our production facility in Mumbai as well as to those working in close co-operation with our global suppliers. It is of vital importance to us that we only work with suppliers that share our commitment to high quality. That is why our association has always been with talented, creative designers who have a responsible attitude towards design. And that is why we carefully select our suppliers so that we can work closely with them and supervise the whole production affair.

To achieve a perfect balance between carefully selected raw materials, beautiful design, functionality and good value is our moto. Every little piece, detail, line and material has been meticulously considered to ensure that the end result will work wonders in your home.

The entire GM product range catalogue can be found online on our website [www.gmmodular.com](http://www.gmmodular.com).

You can follow GM on Facebook, Twitter, Instagram, You Tube and LinkedIn.



[gmmodular.com](http://gmmodular.com)

GM ELEKTRA PVT. LTD. 303, Shalimar Morya Park, New Link Road, Andheri (W), Mumbai-400053, Maharashtra, India. • Customer Care No.: 1800 258 7727 • Email: [care@gmelektra.com](mailto:care@gmelektra.com)



PL DBR FAN OCT 21