

Foreword

Thank you for purchasing this product.

This TT685N camera flash applies to Nikon DSLR series cameras and is compatible with i-TTL autoflash. With this i-TTL compatible flash, your shooting will become simpler. You can easily achieve a correct flash exposure even in complex light-changing environments. This camera flash features:



- GN60 (m ISO 100, @200mm). 22 steps from 1/1 to 1/128.
- Fully support Nikon i-TTL camera flash. Workable as Master or Slave unit in a wireless flash group.
- Use dot-matrix LCD panel to make clear and convenient operations.
- With built-in 2.4GHz wireless remote system to support transmitting and receiving.
- Provided multiple functions, include HSS (up to 1/8000s), FEC, etc.
- Use optional FT-16S to adjust flash parameters & trigger the flash.
- Stable consistency and color temperature with good even lighting.
- Support with firmware upgrade.

Warning



- ▲ Always keep this product dry. Do not use in rain or in damp conditions.
- ▲ Do not disassemble. Should repairs become necessary, this product must be sent to an authorized maintenance center.
- ▲ Keep out of reach of children.
- ▲ Stop using this product if it breaks open due to extrusion, falling or strong hit. Otherwise, electric shock may occur if you touch the electronic parts inside it.
- ▲ Do not fire the flash directly into the eyes (especially those of babies) within short distances. Otherwise visual impairment may occur.
- ▲ Do not use the flash unit in the presence of flammable gases, chemicals and other similar materials. In certain circumstance, these materials may be sensitive to the strong light emitting from this flash unit and fire or electromagnetic interference may result.
- ▲ Do not leave or store the flash unit if the ambient temperature reads over 50°C. Otherwise the electronic parts may be damaged.
- ▲ Turn off the flash unit immediately in the event of malfunction.

Contents



27	Foreword
28	Warning
31	Name of Parts
	Body
	Control Panel
	Dot-matrix LCD Panel
	What's in the Box of TT685N?
	Separately Sold Accessories
34	Attaching to a Camera
34	Power Management
35	Flash Mode — i-TTL Autoflash
	 FEC (Flash Exposure Compensation)
	 High-Speed Sync
	 Second-Curtain Sync
37	Flash Mode — M: Manual Flash
38	Flash Mode — RPT: Stroboscopic Flash
39	Wireless Flash Shooting: Optic Transmission
	Wireless Settings
	Setting Master Unit's Flash Mode
	Setting the Communication Channel
	Wireless ID Settings
	i-TTL: Fully Automatic Wireless Flash Shooting
	M: Wireless Flash Shooting with Manual Flash
	RPT: Wireless Flash Shooting with Manual Flash
43	Wireless Flash Shooting: Ratio (2.4G) Transmission
44	Other Applications
	Wireless Control Function
	Sync Triggering
	Modeling Flash
	Auto Focus Assist Beam
	Bounce Flash
	Creating a Catchlight
	ZOOM: Setting the Flash Coverage and Using the Wide Panel
	Low Battery Indicator
47	C.Fn: Setting Custom Functions
48	Protection Function
49	Technical Data
50	Troubleshooting
51	Firmware Upgrade
51	Compatible Camera Models
51	Maintenance

Conventions used in this Manual

- This manual is based on the assumption that both the camera and camera flash's power switches are powered on.
- Reference page numbers are indicated by "p.**".
- The following alert symbols are used in this manual:
 -  The Caution symbol gives supplemental information.
 -  The Note symbol indicates a warning to prevent shooting problem.

Name of Parts

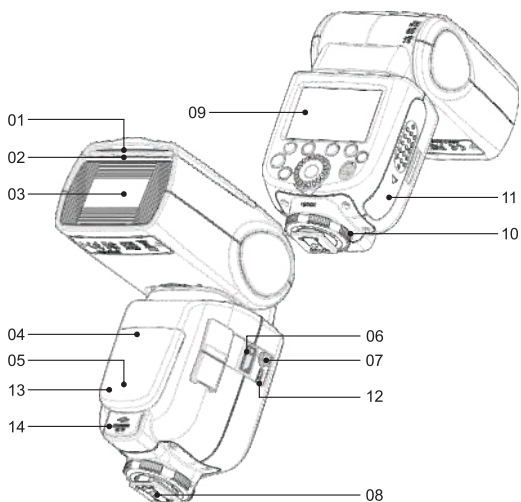

• Body

- | | |
|---------------------------|----------------------------------|
| 01. Catchlight Panel | 08. Hotshoe |
| 02. Built-in Wide Panel | 09. Dot-matrix LCD Panel |
| 03. Flash Head | 10. Lock Ring |
| 04. Optic Control Sensor | 11. Battery Compartment |
| 05. Focus Assist Beam | 12. USB Port |
| 06. Wireless Control Port | 13. Slave Flash Ready Indicator |
| 07. Sync Cord Jack | 14. External Power Supply Socket |

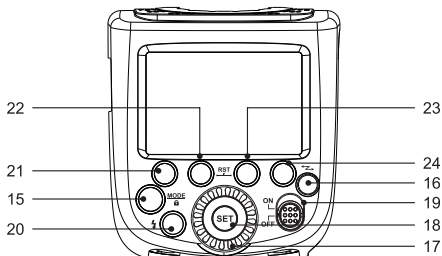

• Control Panel

- | | |
|--|---|
| 15. <MODE> Mode Selection Button / Lock button | 20. <⚡> Test Button / Flash Ready Indicator |
| 16. <◀▶> Wireless Selection Button | 21. Function Button 1 |
| 17. Select Dial | 22. Function Button 2 |
| 18. <SET> Set Button | 23. Function Button 3 |
| 19. ON/OFF Power Switch | 24. Function Button 4 |

• LCD Panel

(1) i-TTL Autoflash

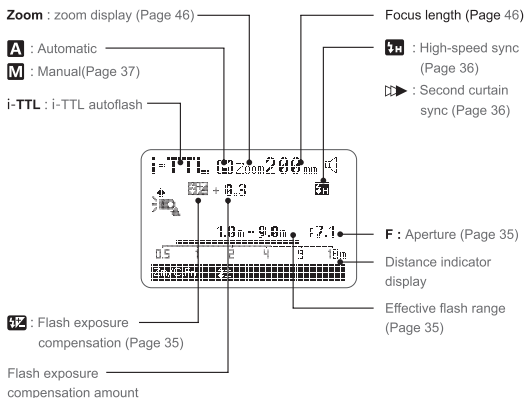

- The display will only show the settings currently applied.
- The functions displayed above function buttons 1 to 4, such as **SYNC** and **±**, change according to settings' status.
- When a button or dial is operated, the LCD panel illuminated.

(2) M Manual Flash

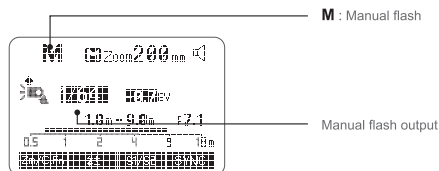

(3) Multi Flash

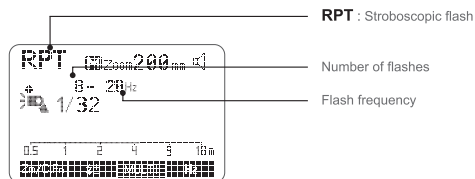

Flash Mode — i-TTL Autoflash

This flash has three flash modes: **i-TTL**, Manual (**M**), and RPT (Stroboscopic). In **i-TTL** mode, the camera and the flash will work together to calculate the correct exposure for the subject and the background. In this mode, multiple TTL functions are available: FEC, HSS, second curtain sync, modeling flash, etc.

* Press **<MODE>** Mode Selection Button and three flash modes will display on the LCD panel one by one with each pressing.

i-TTL Mode

Press **<MODE>** Mode Selection Button to enter i-TTL mode. The LCD panel will display.

- Press the camera release button halfway to focus. The aperture and effective flash range will be displayed in the viewfinder.
- When the shutter button is fully pressed, the flash will fire a pre-flash that the camera will use to calculate exposure and flash output the instant before the photo is taken.

FEC: Flash Exposure Compensation

With FEC function, this flash can adjust from -3 to +3 in 1/3rd stops. It is useful in situations where minor adjusting of the TTL system is needed based on the environment.

Setting FEC:

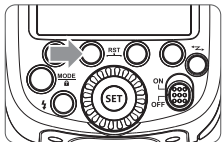

- 1 Press Function Button 2 **< +/- >**. The icon **< +/- >** and flash exposure compensation amount will be highlighted on the LCD panel.

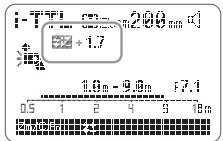

- 2 Set the flash exposure compensation amount.
 - Turn the Select Dial to set the amount.
 - "0.3" means 1/3 step, "0.7" means 2/3 step.
 - To cancel the flash exposure compensation, set the amount to "+0".

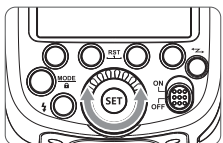

- 3 Press **<SET>** button again to confirm the setting.

High-Speed Sync

High Speed Sync (FP flash) enables the flash to synchronize with all camera shutter speeds. This is convenient when you want to use aperture priority for fill-flash portraits.

Select the high-speed sync icon **< H >**.

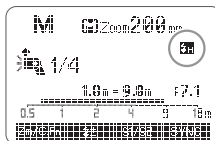

- Set the flash sync speed to 1/320s (Auto FP) or 1/250s (Auto FP) in the Nikon camera menu. Press the shutter button halfway. The icon **< H >** displayed on the flash screen means the high speed sync function is enabled on the flash.
- Turning the camera command dial can set the shutter speed to 1/250s or faster.
- To check if the FP flash function works properly, look through the shutter speed in the viewfinder. If it shows a speed of 1/250s or faster, the FP flash function is on work.

- If you set a shutter speed as 1/320s (Auto FP) or 1/250s (Auto FP) in the Nikon camera setting, **< H >** will be displayed in the flash screen regardless of practical shutter speed.
 - With high-speed sync, the faster the shutter speed, the shorter the effective flash range.
 - To return to normal flash, set the flash sync speed to other options other than Auto FP. Then the icon **< H >** will disappear when pressing the shutter halfway.
 - Multi flash mode cannot be set in high-speed sync mode.
 - Over-temperature protection may be activated after 15 consecutive high-speed sync flashes.

Second-Curtain Sync

With a slow shutter speed, you can create a light train following the subject. The flash fires right before the shutter closes.

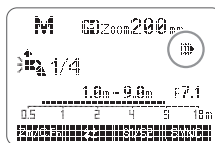

- Set the camera to Rear mode and press the shutter button halfway, then the flash display panel will show the second curtain sync icon **< H >**.
- When the camera is not set to Rear mode, pressing the shutter button halfway will not light up the icon **< H >** on the flash display panel.

Flash Mode — M: Manual Flash

The flash output is adjustable from 1/1 full power to 1/128th power in 1/3rd stop increments. To obtain a correct flash exposure, use a hand-held flash meter to determine the required flash output.

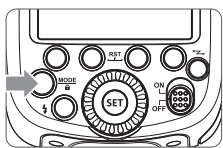

1 Press <MODE> button so that <M> is displayed.

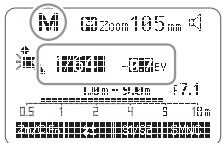

2 Turn the Select Dial to choose a desired flash output amount.

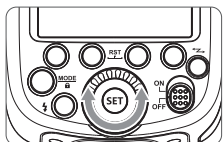

3 Press <SET> button again to confirm the setting.

Flash Output Range

The following table makes it easier to see how the stop changes in terms of f/stop when you increase or decrease the flash output. For example, when you decrease the flash output to 1/2, 1/2-0.3, or 1/2-0.7, and then increase the flash output to more than 1/2, 1/2+0.3, 1/2+0.7, and 1/1 will be displayed.

Figures displayed when reducing flash output level→

1/1	1/1-0.3	1/1-0.7	1/2	1/2-0.3	1/2-0.7	1/4
	1/2+0.7	1/2+0.3		1/4+0.7	1/4+0.3	

←Figures displayed when increasing flash output level

Optic S1 Secondary Unit Setting

In M manual flash mode, press <S1/S2> button so that this flash can function as an optic S1 secondary flash with optic sensor. With this function, the flash will fire synchronously when the main flash fires, the same effect as that by the use of radio triggers. This helps create multiple lighting effects.

Optic S2 Secondary Unit Setting

Press <S1/S2> button so that this flash can also function as an optic S2 secondary flash with optic sensor in M manual flash mode. This is useful when cameras have pre-flash function. With this function, the flash will ignore a single "pre-flash" from the main flash and will only fire in response to the second, actual flash from the main unit.

Manual Off Camera High-speed Setting

In M manual flash mode, press <SYNC> button to select high-speed mode and is displayed.

- S1 and S2 optic triggering and off camera high-speed mode are only available in M manual flash mode.

Flash Mode — RPT: Stroboscopic Flash

With stroboscopic flash, a rapid series of flashes is fired. It can be used to capture a multiple images of a moving subject in a single photograph.

You can set the firing frequency (number of flashes per sec. expressed as Hz), the number of flashes, and the flash output.

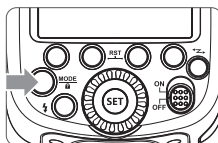

1 Press <MODE> button so that <RPT> is displayed.

2 Turn the Select Dial to choose a desired flash output.

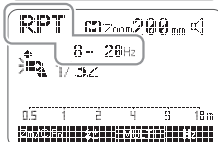

3 Set the flash frequency and flash times.

- Press Function Button 3 <MULTI> button to select the item (blinks).
- Turn the Select Dial to set the number and press Function Button 4 <Hz> button again to confirm. The next item to be set will blink.
- After you finish the setting, press <SET> button and all the settings will be displayed.

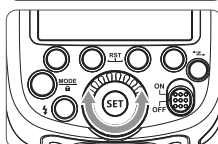

Calculating the Shutter Speed

During stroboscopic flash, the shutter remains open until the firing stops. Use the formula below to calculate the shutter speed and set it with the camera.

$$\text{Number of Flashes} / \text{Flash Frequency} = \text{Shutter Speed}$$

For example, if the number of flashes is 10 and the firing frequency is 5 Hz, the shutter speed should be at least 2 seconds.

- ▲ To avoid overheating and deteriorating the flash head, do not use stroboscopic flash more than 10 times in succession. After 10 times, allow the camera flash to rest for at least 15 minutes. If you try to use the stroboscopic flash more than 10 times in succession, the firing might stop automatically to protect the flash head. If this happens, allow at least 15 minutes' rest for the camera flash.

- Stroboscopic flash is most effective with a highly reflective subject against a dark background.
- Using a tripod and a remote control is recommended.
- A flash output of 1/1 and 1/2 cannot be set for stroboscopic flash.
- Stroboscopic flash can be used with "buLb".
- If the number of flashes is displayed as "--", the firing will continue until the shutter closes or the battery is exhausted. The number of flashes will be limited as shown by the following table.

Maximum Stroboscopic Flashes:

Flash output \ Hz	1	2	3	4	5	6-7	8-9
1/4	7	6	5	4	4	3	3
1/8	14	14	12	10	8	6	5
1/16	30	30	30	20	20	20	10
1/32	60	60	60	50	50	40	30
1/64	90	90	90	80	80	70	60
1/128	90	90	90	90	90	90	80

Flash output \ Hz	10	20-50	60-199			
1/4	2	2	2			
1/8	4	4	4			
1/16	8	8	8			
1/32	20	16	12			
1/64	50	30	20			
1/128	70	40	40			

Wireless Flash Shooting: Optic Transmission

This product is compatible with Nikon Creative Lighting System (CLS). It can function as either an optic wireless master or slave flash. As a master unit, it can control Nikon speedlights e.g. SB-900 and SB-910 via wireless. As a slave unit, it can be controlled by wireless signals of Nikon speedlights e.g. SB-900 and pop-up flash commanders of Nikon cameras e.g. D7100/D7000/D800.

- You can set up three slave groups for i-TTL autoflash shooting. With i-TTL autoflash, you can easily create various lighting effects.
- Any flash settings for the slave units on the master flash in i-TTL / Manual / RPT mode will be automatically sent to the slave units. So the only thing you need to do is to set the master unit for each slave group without any operation for the slave units at all during the shooting.
- This flash can work in i-TTL / M / RPT / OFF flash modes when set as a master unit.

Slave/Master Unit's Positioning and Operation Range

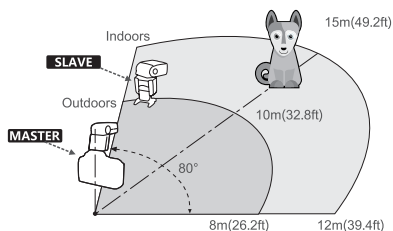

- Even with multiple slave units, the master unit can control all of them via wireless.
- In this user manual, "master unit" refers to the camera flash on a camera and "slave unit" will be controlled by the master unit.

1. Wireless Settings

You can switch between normal flash and wireless flash. For normal flash shooting, be sure to set the wireless setting to OFF.

Master Unit Setting

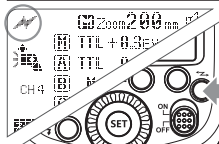

Press < > button so that < > is displayed on the LCD panel. If < RPT > is displayed, it means RPT mode is ON. The backlight turns green now.

Slave Unit Setting

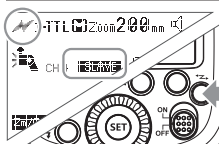

Press < > button again so that < > and < SLAVE > are displayed on the LCD panel. The backlight turns orange now.

2. Setting Master Unit's Flash Mode

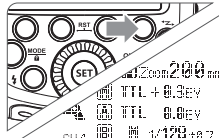

1 Press Function Button 4 < Gr > to choose the group from M/A/B/C. Then, press Function Button 3 < MODE > so that the master unit can work in OFF / i-TTL / M flash mode.

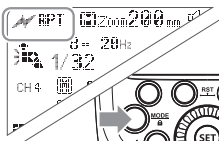

Choose one of them as the flash mode of master unit.

2 Press the "MODE/Lock" button can change to RPT mode.

3. Setting the Communication Channel

If there are other wireless flash systems nearby, you can change the channel IDs to prevent signal interference. The channel IDs of the master unit and the slave unit(s) must be set to the same.

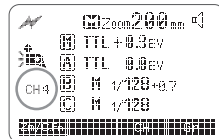

1 Press Function Button 3 < CH > and turn the Select Dial to choose a channel ID from 1 to 4.

2 Press the < SET > button to confirm.

4. Wireless ID Settings

Change the wireless channels and wireless ID to avoid interference for it can only be triggered after the wireless IDs and channels of the master unit and the slave unit are set to the same.

Press the < MENU > button to enter C.Fn ID. Press the < SET > button to choose OFF channel expansion shutdown, and choose any figure from 01 to 99.

5. i-TTL : Fully Automatic Wireless Flash Shooting

Using Automatic Wireless Flash with a Single Slave Unit

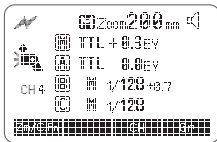

1 Master Unit Setting

- Attach a TT685N camera flash on the camera and set it as the master Unit. (Page 40)
- M/A/B/C can be set as TTL mode independently.

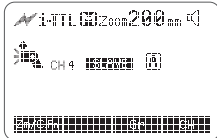

2 Slave Unit Setting

- Set the other camera flash as the wireless slave Unit. (Page 40)
- The slave unit can be set as A/B/C.

3 Check the communication channel.

- If the master unit and slave unit(s) are set to a different channel, set them to the same channel. (Page 40)

4 Position the camera and flashes.

- Position the camera and flashes as the picture shows. (Page 39)

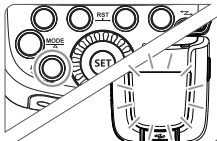

5 Check that the flash is ready.

- Check that the master flash ready indicator is lightened.
- When the slave flash ready indicator is ready, the AF-assist beam lighting area will blink at 1 second intervals.

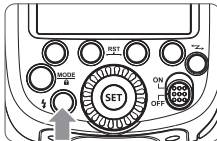

6 Check the flash operation.

- Press the master unit's Test Button < ⚡ >.
- Then, the slave unit will fire. If not, adjust the slave unit's angle toward the master unit and distance from the master unit.

⚠ The slave unit might be out of order or fire an unwanted flash due to the nearby fluorescent lamp or computer screen.

- If the slave unit's auto power off function is workable, press the master unit's test button to power it on. Please note that test firing is unavailable during the camera's regular metering time.
- The effective time of slave auto power off is changeable. (C.Fn-Sv APOT Page 47)
- By making some settings, the auto AF-assist transmitter will not blink after the slave unit's flash ready indicator is lightened. (C.Fn-AF Page 47)

Using Fully Automatic Wireless Flash

The FEC and other settings that set on the master unit will also be appeared on the slave unit automatically. The slave unit does not need any operation. Use the following settings to make wireless flashes according to the same methods with normal flash shooting.

- Flash Exposure Compensation (**F±** Page 35)
- High-Speed Sync (**SYNC** Page 37)

About Master Unit

Use two or more master units. By preparing several cameras that with master units flash attached, cameras can be changed in shooting while keeping the same lighting source (slave unit).

6. M: Wireless Flash Shooting with Manual Flash

This describes wireless (multiple shooting) using manual flash. You can shoot with a different flash output setting for each slave unit (firing group). Set all parameters on the master unit.

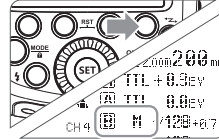

1 Setting the flash mode to <M>.

- Press Function Button 4 < **Gr** > to choose groups. Then, press Function Button 3 < **MODE** > to set the flash to **M** mode.

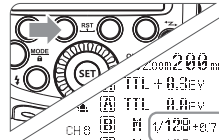

2 Setting flash output.

- Press Function Button 2 < **F±** >. Turn the Select Dial to set the flash output of the groups. Press the < **SET** > button to confirm.

3 Taking the picture.

- Each group fires at the set flash ratio.

7. RPT: Wireless Flash Shooting with Manual Flash

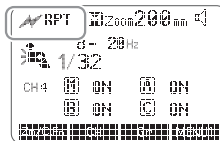

Setting <RPT> stroboscopic flash.

- Press < **MODE** > button so that < **RPT** > is displayed.
- Setting the stroboscopic flash. (Page 38)

The firing frequency of stroboscopic flash during the optic transmission wireless shooting can be set from 1Hz to 100Hz (settings from 250 Hz to 500 Hz are not available).

Wireless Flash Shooting: Radio (2.4G) Transmission

Using a flash (master/slave) with a radio transmission wireless shooting function make it easy to shoot with advanced wireless multiple flash lighting, in the same way as i-TTL autoflash shooting. The basic relative position and operation range are as shown in the picture. You can then perform wireless i-TTL autoflash shooting just by setting the master unit to <i-TTL>.

Positioning and Operation Range (Example of wireless flash shooting)

- Autoflash Shooting with One Slave Unit

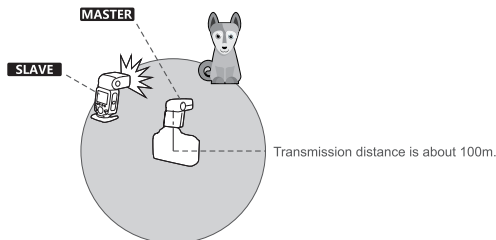

- Use the supplied mini stand to position the slave unit.
- Before shooting, perform a test flash and test shooting.
- The transmission distance might be shorter depending on the conditions such as positioning of slave units, the surrounding environment and whether conditions.

Wireless Multiple Flash Shooting

You can divide the slave units into two or three groups and perform i-TTL autoflash while changing the flash ratio (factor). In addition, you can set and shoot with a different flash mode for each firing group, for up to 5 groups.

- Auto Shooting with Two Slave Groups

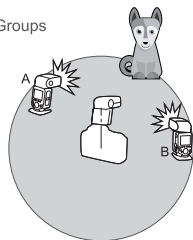

- Auto Shooting with Three Slave Groups

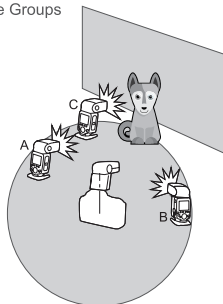

Wireless shooting using radio transmission has advantages over wireless shooting using optic transmission, such as being less affected by obstacles, and not having to point the slave unit's wireless sensor toward the master unit. The main functional differences are as follows:

Function	Radio Transmission	Optic Transmission
Distance	100m	15m
Channel	1~32	1~4
To be disturbed	Hard	Easy

⚠ The Reason & Solution of Not Triggering in Godox 2.4G Wireless

1. **Disturbed by the 2.4G signal in outer environment** (e.g. wireless base station, 2.4G wifi router, Bluetooth, etc.)
 - To adjust the channel CH setting on the flash trigger (add 10+ channels) and use the channel which is not disturbed. Or turn off the other 2.4G equipment in working.
2. **Please make sure that whether the flash has finished its recycle or caught up with the continuous shooting speed or not**(the flash ready indicator is lighten) and the flash is not under the state of over-heat protection or other abnormal situation.
 - Please downgrade the flash power output. If the flash is in TTL mode, please try to change it to M mode(a preflash is needed in TTL mode).
3. **Whether the distance between the flash trigger and the flash is too close or not**
 - Please turn on the "close distance wireless mode" on the flash trigger (<0.5m):
 - X1 series: press the test button and hold on, then turning it on until the flash ready indicator blinks for 2 times.
 - XPro series: Set the C.Fn-DIST to 0-30m.
4. **Whether the flash trigger and the receiver end equipment are in the low battery states or not**
 - Please replace the battery(the flash trigger is recommended to use 1.5V disposable alkaline battery).

Other Applications

Wireless Control Function

The flash unit is built in with a Wireless Control Port so that you can wirelessly adjust the power level of the flash and the flash triggering. To control the flash wirelessly, you need a FT-16S remote control set (on-camera and on-flash). Insert its receive end into the Wireless Control Port on the flash and insert the transmit end into the camera hot shoe. Settings made on the hotshoe-mounted transmit and receive ends will be wirelessly communicated to the flash. Then you can press the camera shutter release button to trigger the flash. You can also hold the transmit end at hand to control your off-camera flash.



- For full instructions on the use of FT series remote control, see its user manual.

Sync Triggering

The Sync Cord Jack is a $\Phi 3.5$ mm plug. Insert a trigger plug here and the flash will be fired synchronously with the camera shutter.

Modeling Flash

If the camera has a depth-of-field preview button, pressing it will fire the flash continuously for 1 second. This is called modeling flash. It enables you to see the shadow effects on the subject and the lighting balance. You can fire the modeling flash during wireless or normal flash shooting.

- ▲ To avoid overheating and deteriorating the flash head, do not fire the modeling flash for more than 10 consecutive times. If you fire the modeling flash 10 consecutive times, allow at least 10 minutes' break for the camera flash.

Auto Focus Assist Beam

In poorly-lit or low-contrast shooting environments, the built-in auto focus assist beam will automatically light on to make it easier for autofocus. The beam will light up only when autofocus is difficult and get out as soon as the autofocus becomes correct.

If you want to turn off the auto focus assist beam, set the "AF" to "OFF" on the C.Fn settings.

- 📷 If you find the auto focus assist beam does not light up, this is because the camera has got a correct autofocus.

Position	Effective Range
Center	0.6~10m / 2.0~32.8 feet
Periphery	0.6~5m / 2.0~16.4 feet

Bounce Flash

By pointing the flash head toward a wall or ceiling, the flash will bounce off the surface before illuminating the subject. This can soften shadows behind the subject for a more natural-looking shot. This is called bounce flash.

To set the bounce direction, hold the flash head and turn it to a satisfying angle.

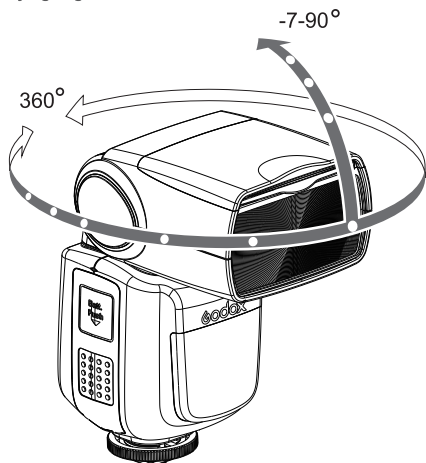

- 📷 If the wall or ceiling is too far away, the bounced flash might be too weak and result in underexposure.
- The wall or ceiling should be a plain, white color for high reflectance. If the bounce surface is not white, a color cast may appear in the picture.

Creating a Catchlight

With the catchlight panel, you can create a catchlight in the subject's eyes to add life to the facial expression.

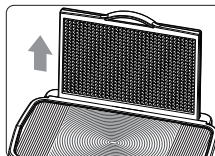

- 1 Point the flash head upward by 90°.
- 2 Pull out the wide panel. The catchlight panel will come out at the same time.

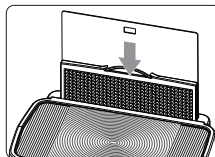

- 3 Push the wide panel back in.
 - Push in only the wide panel.
 - Follow the same procedures as for bounce flash.

- ▲ Point the flash head straight ahead and then upward by 90°. The catchlight will not appear if you swing the flash head left or right.
- For best catchlight effect, stay 1.5m/4.9ft away from the subject.

ZOOM: Setting the Flash Coverage and Using the Wide Panel

The flash coverage can be set automatically or manually. It can be set to match the lens focal length from 20 mm to 200mm. Also, with the built-in wide panel, the flash coverage can be expanded for 14mm wide-angle lenses.

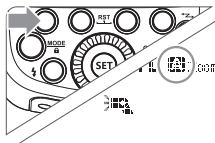

In Manual Zoom mode, press the **<ZOOM/C.FN>** button.

- Turn the Select Dial to change the flash coverage.
- If **<A>** is displayed, the flash coverage will be set automatically.

- 📷 If you set the flash coverage manually, make sure it covers the lens focal length so that the picture will not have a dark periphery.

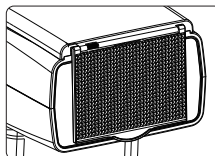

Using the Wide Panel

Pull out the wide panel and place it over the flash head as shown. The flash coverage will then be extended to 14 mm.

- The catchlight panel will come out at the same time. Push the catchlight panel back in.
- The **<ZOOM/C.FN>** button will not work.

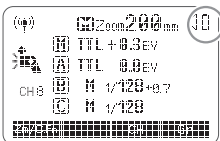

Low Battery Warning

If the battery power is low,  will appear and blink on the LCD panel. Please replace the battery immediately.

C.Fn: Setting Custom Functions

The following table lists the available and unavailable custom functions of this flash.

C.Fn Custom Functions			
Custom Function Signs	Function	Setting No.	Settings & Description
m/ft	Distance indicator	m	m
		ft	feet
APO	Auto power off	ON	ON
		OFF	OFF
AF	AF-assist beam	ON	ON
		OFF	OFF
Sv APOT	Slave auto power off timer	60min	60min
		30min	30min
BEEP	Beeper	ON	ON
		OFF	OFF
LIGHT	Backlighting time	12sec	Off in 12 sec.
		OFF	Always off
		ON	Always lighting
LCD	LCD contrast ratio	0-9	10 levels
ID	Wireless ID	OFF	Off
		01-99	Choose any figure from 01-99
Sv LED	Wireless LED Lamp	OFF	Off
		ON	on

- Press **<Zm/C.Fn>** Backlight/Custom Setting Button for 2 seconds or longer until C.Fn menu is displayed. The "Ver x.x" in the top-right corner refers to the software version.
- Select the Custom Function No.
 - Turn the Select Dial to choose the Custom Functions.
- Change the Setting.
 - Press **<SET>** button and the Setting No. blinks.
 - Turn the Select Dial to set the desired number. Pressing **<SET>**
- In the C.Fn states, long press the "Clear" button for 2 seconds until "OK" is displayed on the panel, which means the values in C.Fn can be reset.

Protection Function

1. Over-Temperature Protection

- To avoid overheating and deteriorating the flash head, do not fire more than 30 continuous flashes in fast succession at 1/1 full power. After 30 continuous flashes, allow a rest time of at least 10 minutes.
- If you fire more than 30 continuous flashes and then fire more flashes in short intervals, the inner over-temperature protection function may be activated and make the recycling time over 10 seconds. If this occurs, allow a rest time of about 10 minutes, and the flash unit will then return to normal.
- When the over-temperature protection is started,  is shown on the LCD display.

Number of flashes that will activate over-temperature protection:

Power Output Level	Number of Flashes
1/1	30
1/2 +0.7	40
1/2 +0.3	50
1/2	60
1/4(+0.3,+0.7)	100
1/8(+0.3,+0.7)	200
1/16(+0.3,+0.7)	300
1/32(+0.3,+0.7)	500
1/64(+0.3,+0.7)	1000
1/128(+0.3,+0.7)	

Number of flashes that will activate over-temperature protection in high-speed sync triggering mode:

Power Output	Times
1/1	15
1/2(+0.3,+0.7);	20
1/4(+0.3,+0.7)	30
1/8(+0.3,+0.7);	
1/16(+0.3,+0.7)	40
1/32(+0.3,+0.7);	
1/64(+0.3,+0.7);	50
1/128(+0.3,+0.7);	

2. Other Protections

The system provides real-time protection to secure the device and your safety. The following lists prompts for your reference:

Prompts on LCD Panel	Meaning
E1	A failure occurs on the recycling system so that the flash cannot fire. Please restart the flash unit. If the problem still exists, please send this product to a maintenance center.
E2	The system gets excessive heat. Please allow a rest time of 10 minutes.
E3	The voltage on two outlets of the flash tube is too high. Please send this product to a maintenance center.
E9	There are some errors occurred during the upgrading process. Please using the correct firmware upgrade method.

Technical Data

Model	TT685N
• Type	
Compatible Cameras	Nikon DSLR cameras (i-TTL autofocus)
Guide No. (1/1 output @ 200mm)	60 (m ISO 100) 190 (feet ISO 100)
Flash Coverage	20 to 200mm (14mm with wide panel) • Auto zoom (Flash coverage set automatically to match the lens focal length and image size) • Manual zoom • Swinging/tilting flash head (bounce flash): 0 to 360° horizontally and -7° to 90° vertically
Flash Duration	1/300 to 1/20000 seconds
• Exposure Control	
Exposure control system	i-TTL autofocus and manual flash
Flash exposure compensation (FEC)	Manual, FEB: ±3 stops in 1/3 stop increments (Manual FEC and FEB can be combined.)
Sync mode	High-speed sync (up to 1/8000 seconds), first-curtain sync, and second-curtain sync
Multi flash	Provided (up to 90 times, 100Hz)
• Wireless Flash (Optic transmission and 2.4G transmission)	
Wireless flash function	Master, Slave, Off
Controllable slave groups	3 (A, B, and C)
Transmission range (approx.)	Optic
	Indoors: 12 to 15 m / 39.4 to 49.2 ft. Outdoors: 8 to 10 m / 26.2 to 32.8 ft. Master unit reception angle: ±40° horizontally, ±30° vertically
Channels	2.4G
	100m
Slave-ready indicator	Optic
	4 (1, 2, 3, and 4)
Modeling flash	2.4G
	32 (1~32)
Slave-ready indicator	Two red indicators blink
Modeling flash	Fired with camera's depth-of-field preview button
• Auto Focus Assist Beam	
Effective range (approx.)	Center: 0.6~10m / 2.0~32.8 feet
	Periphery: 0.6~5m / 2.0~16.4 feet
• Power Supply	
AA batteries	Ni-MH batteries (recommended) or 4*LR6 alkaline batteries
Recycle time	Approx. 0.1-2.6 seconds (enloop Ni-MH batteries of Panasonic). Red LED indicator will light up when the flash is ready.
Full power flashes	Approx. 230 (2500mA Ni-MH batteries)
Power saving	Power off automatically after approx. 90 seconds of idle operation. (60 minutes if set as slave)
• Sync Triggering Mode	Hotshoe, 3.5mm sync line, Wireless control port
• Color Temperature	5600±200k
• Dimensions	
W x H x D	64*76*190 mm
Weight without battery	410g
Weight with battery	530g
2.4G Frequency Range	2413.0MHz-2465.0MHz
Max. Transmitting Power	5dbm

Troubleshooting

If there is a problem, refer to this Troubleshooting Guide.

The Camera Flash cannot be charged.

- The battery is installed in the wrong direction.
 - Install the battery in the correct direction.
- The camera flash's internal battery is exhausted.
 - If <  > appears and blinks on the LCD panel, replace the battery immediately.

The Camera Flash does not fire.

- The camera flash is not attached securely to the camera.
 - Attach the camera's mounting foot securely to the camera.
- The electrical contacts of the Camera Flash and camera are dirty.
 - Clean the contacts.

The power turns off by itself.

- After 90 seconds of idle operation, auto power off took effect if the flash is set as master.
 - Press the shutter button halfway or press any flash button to wake up.
- After 60 minutes (or 30 minutes) of idle operation, the flash unit will enter sleep mode if it is set as slave.
 - Press any flash button to wake up.

Auto zoom does not work.

- The camera flash is not attached securely to the camera.
 - Attach the camera flash's mounting foot to the camera.

The flash exposure is underexposed or overexposed.

- You used high-speed sync.
 - With high-speed sync, the effective flash range will be shorter. Make sure the subject is within the effective flash range displayed.
- You used Manual Flash mode.
 - Set the flash mode to i-TTL or modify the flash output.

Photos have dark corners or only parts of the target subject are illuminated.

- The focal length of lens exceeds the flash coverage.
 - Check the flash coverage you set. This flash unit has the flash coverage between 20 and 200mm, which fits medium-format cameras. Pull the wide panel out to extend the flash coverage.

Firmware Upgrade

This flash supports firmware upgrade through the USB port. Update information will be released on our official website.

- USB connection line is not included in this product. The USB port is a standard Micro USB socket. Common USB connection line is applicable.

Compatible Camera Models

This flash unit can be used on the following

Nikon DSLR camera models:

D800	D700	D7100	D7000	D5200	D5100	D5000
D300	D300S	D3200	D3100	D3000	D200	D70S
D810	D610	D90				

- This table only lists the tested camera models, not all Nikon DSLR series cameras. For the compatibility of other camera models, a self-test is recommended. Rights to modify this table are retained.

Maintenance

- Shut down the device immediately should abnormal operation be detected.
- Avoid sudden impacts and the product should be dedusted regularly.
- It is normal for the flash tube to be warm when in use. Avoid continuous flashes if unnecessary.
- Maintenance of the flash must be performed by our authorized maintenance department which can provide original accessories.
- This product, except consumables e.g. flash tube, is supported with a one-year warranty.
- Unauthorized service will void the warranty.
- If the product had failures or was wetted, do not use it until it is repaired by professionals.
- Changes made to the specifications or designs may not be reflected in this manual.

FCC Statement

This device complies with part 15 of the FCC Rules. Operation is subject to the following two conditions: (1) This device may not cause harmful interference, and (2) this device must accept any interference received, including interference that may cause undesired operation.

Any Changes or modifications not expressly approved by the party responsible for compliance could void the user's authority to operate the equipment.

Note: This equipment has been tested and found to comply with the limits for a Class B digital device, pursuant to part 15 of the FCC Rules. These limits are designed to provide reasonable protection against harmful interference in a residential installation. This equipment generates uses and can radiate radio frequency energy and, if not installed and used in accordance with the instructions, may cause harmful interference to radio communications. However, there is no guarantee that interference will not occur in a particular installation. If this equipment does cause harmful interference to radio or television reception, which can be determined by turning the equipment off and on, the user is encouraged to try to correct the interference by one or more of the following measures:

- Reorient or relocate the receiving antenna.
- Increase the separation between the equipment and receiver.
- Connect the equipment into an outlet on a circuit different from that to which the receiver is connected.
- Consult the dealer or an experienced radio/TV technician for help.

The device has been evaluated to meet general RF exposure requirement.

The device can be used in portable exposure condition without restriction.

Warning

Operating frequency:2412.99MHz-2464.49MHz
Maximum EIRP Power: 2.53dBm

Declaration of Conformity

GODOX Photo Equipment Co.,Ltd. hereby declares that this equipment are in compliance with the essential requirements and other relevant provisions of Directive 2014/53/EU. In accordance with Article 10(2) and Article 10(10), this product is allowed to be used in all EU member states.For more information of DoC, Please click this web link:

https://www.godox.com/DOC/Godox_TT685_Series_DOC.pdf

The device complies with RF specifications when the device used at 0mm from your body.

产品保修

尊敬的用户，本保修卡是申请保修服务的重要凭证，请您配合销售商填写并妥善保管，谢谢！

产品信息	型号	产品条码
用户信息	姓名	联系电话
	通信地址	
销售商信息	名称	
	联系电话	
	通信地址	
	销售日期	
备注		

注：此表应由销售商盖章确认。

适用范围

本文件适用于相关《产品保修信息》(见后面说明)所列产品，其他非属此范围的产品或部件(如促销品、赠品及其他出厂后附加的部件等)不在此保修承诺内。

保修期

产品及部件的相应保修期按相关的《产品保修信息》执行。保修期自产品首次购买日起算，购买日以购买产品时保修卡登记日期为准。

如何获得保修服务

要保修服务，您可直接与产品销售商或授权服务机构联系，也可拨打神牛产品售后服务电话，与我们联系，由我们的服务人员为您安排服务。申请保修时，您应提供有效的保修卡作为保修凭证，方可获得保修。如您不能提供有效的保修卡，则在我们可确认产品或部件属于保修范围的情况下，也可以为您提供保修，但这不作为我们的义务。

不适用保修的情况

如产品存在下列情况，本文件项下的保证和服务将不适用 ①产品或部件超过相应保修期；②错误或不适当使用、维护或保管导致的故障或损坏，如：不当搬运；不按产品合理预期用途使用；不当插接外接设备；跌落或外力挤压；接触或暴露于不适当温度、溶剂、酸碱、水浸或潮湿环境；③由非神牛授权机构或人员安装、修理、更改、添加或拆卸造成的故障或损坏；④产品或部件原有识别信息被修改变更或删除；⑤无效保修卡；⑥使用非法授权、非标准或非公开发行的软件造成的故障或损坏；⑦因不可抗力或意外事件造成的故障或损坏；⑧其他非因产品本身质量问题导致的故障或损坏。遇上述情况，您应向相关责任方寻求解决，神牛对此不承担任何责任。因非在保修期或保修范围内的部件、附件或软件导致产品不能正常使用，不是保修范围内的故障。产品使用过程中正常的褪色，磨损和消耗，不是保修范围内的故障。

产品保修和服务支持信息

产品的保修期和服务类型按以下《产品保修信息》执行：

产品类别	选件名称	保修期(月)	保修服务类型
部件	电路板	12	客户送修
	电池	3	客户送修
	充电器、电源线，同步线等带电性能的部件。	12	客户送修
其他	如闪光灯、造型灯泡、外壳、保护罩、锁紧装置、包装等。	无	无保修

神牛产品售后服务电话 0755-29609320-8062

Warranty

Dear customers, as this warranty card is an important certificate to apply for our maintenance service, please fill in the following form in coordination with the seller and safekeep it. Thank you!

Product Information	Model	Product Code Number
Customer Information	Name	Contact Number
	Address	
Seller Information	Name	
	Contact Number	
	Address	
	Date of Sale	
Note:		

Note: This form shall be sealed by the seller.

Applicable Products

The document applies to the products listed on the **Product Maintenance Information** (see below for further information). Other products or accessories (e.g. promotional items, giveaways and additional accessories attached, etc.) are not included in this warranty scope.

Warranty Period

The warranty period of products and accessories is implemented according to the relevant **Product Maintenance Information**. The warranty period is calculated from the day (purchase date) when the product is bought for the first time. And the purchase date is considered as the date registered on the warranty card when buying the product.

How to Get the Maintenance Service

If maintenance service is needed, you can directly contact the product distributor or authorized service institutions. You can also contact the Godox after-sale service call and we will offer you service. When applying for maintenance service, you should provide valid warranty card. If you cannot provide valid warranty card, we may offer you maintenance service once confirmed that the product or accessory is involved in the maintenance scope, but that shall not be considered as our obligation.

Inapplicable Cases

The guarantee and service offered by this document are not applicable in the following cases: ①. The product or accessory has expired its warranty period; ②. Breakage or damage caused by inappropriate usage, maintenance or preservation, such as improper packing, improper usage, improper plugging in/out external equipment, falling off or squeezing by external force, contacting or exposing to the improper temperature, solvent, acid, base, flooding and damp environments, etc; ③. Breakage or damage caused by non-authorized institution or staff in the process of installation, maintenance, alteration, addition and detachment; ④. The original identifying information of product or accessory is modified, alternated, or removed; ⑤. No valid warranty card; ⑥. Breakage or damage caused by using illegally authorized, nonstandard or non-public released software; ⑦. Breakage or damage caused by force majeure or accident; ⑧. Breakage or damage that could not be attributed to the product itself. Once met these situations above, you should seek solutions from the related responsible parties and Godox assumes no responsibility. The damage caused by parts, accessories and software that beyond the warranty period or scope is not included in our maintenance scope. The normal discoloration, abrasion and consumption are not the breakage within the maintenance scope.

Maintenance and Service Support Information

The warranty period and service types of products are implemented according to the following **Product Maintenance Information**:

Product Type	Name	Maintenance Period(month)	Warranty Service Type
Parts	Circuit Board	12	Customer sends the product to designated site
	Battery	3	Customer sends the product to designated site
	Electrical parts e.g. battery charger, power cord, sync cable, etc.	12	Customer sends the product to designated site
Other Items	Flash tube, modeling lamp, lamp body, lamp cover, locking device, package, etc.	No	Without warranty

Godox After-sale Service Call 0755-29609320-8062