

SONY[®]

Home Theatre System

Operating Instructions

WARNING

Do not install the speaker system in a confined space, such as a bookcase or built-in cabinet.

To reduce the risk of fire, do not cover the ventilation opening of the speaker system with newspapers, tablecloths, curtains, etc.

Do not expose the speaker system to naked flame sources (for example, lighted candles).

To reduce the risk of fire or electric shock, do not expose this speaker system to dripping or splashing, and do not place objects filled with liquids, such as vases, on the speaker system.

The speaker system is not disconnected from the mains as long as it is connected to the AC outlet, even if the speaker system itself has been turned off.

As the mains plug is used to disconnect the speaker system from the mains, connect the speaker system to an easily accessible AC outlet. Should you notice an abnormality in the speaker system, disconnect the mains plug from the AC outlet immediately.

CAUTION

Risk of explosion if the battery is replaced by an incorrect type. Do not expose batteries or appliances with battery-installed to excessive heat, such as sunshine and fire.

Do not place this product close to medical devices.

This product (including accessories) has magnet(s) which may interfere with pacemakers, programmable shunt valves for hydrocephalus treatment, or other medical devices. Do not place this product close to persons who use such medical devices. Consult your doctor

before using this product if you use any such medical device.

Indoor use only.

Recommended cables

Properly shielded and grounded cables and connectors must be used for connection to host computers and/or peripherals.

For the bar speaker and surround speakers

The nameplates are located on the bottom of the bar speaker and surround speakers.

This equipment has been tested and found to comply with the limits set out in the EMC regulation using a connection cable shorter than 3 meters.



Disposal of old electrical & electronic equipment (applicable in the European Union and other countries with separate

collection systems)

Table of Contents

About Manuals of the Speaker System	4
---	---

What's in the Box	➔ Startup Guide (separate document)
-------------------	-------------------------------------

What You Can Do with the Speaker System	5
Guide to Parts and Controls	6

Installation and Connection

Basic Installation and Connection	➔ Startup Guide (separate document)
-----------------------------------	-------------------------------------

Mounting the Speaker System on a Wall	11
Connecting the Wireless Amplifier Manually	14
Connecting Sony TV with the BLUETOOTH Function Wirelessly	15

Listening to Music/Sound

Listening to a TV	18
Listening to Music on a USB Device	18
Listening to Music with the BLUETOOTH® Function	20
Listening to Music on an Audio Device Connected with a Stereo Mini Cable	23

Adjusting the Sound Quality

Setting the Sound Effect that is Tailored to Sound Sources (Sound Mode)	24
Making Dialogs Clearer (VOICE)	25
Enjoying Clear Sound with Low Volume at Midnight (NIGHT)	25
Checking the Current Sound Settings	26

Using the Speaker System by Interlocking with a TV

Operating the Speaker System by Interlocking with a TV (Control for HDMI function)	27
--	----

Changing the Settings

Using the Setting Menu	29
Changing the Brightness of the Front Panel Display and Indicators (DIMMER)	33
Saving Power Consumption	33

Troubleshooting

Troubleshooting	34
Resetting the Speaker System	40

Additional Information

Specifications	41
Playable Types of Files	43
Supported Input Audio Formats	43
On BLUETOOTH Communication	44
Precautions	45
Index	47

About Manuals of the Speaker System

- The instructions in these manuals describe the controls on the remote control.
- Some illustrations are presented as conceptual drawings, and may be different from the actual products.
- Characters in brackets [] appear on the front panel display.

What's in the Box

Refer to Startup Guide (separate document).

What You Can Do with the Speaker System

"Listening to a TV" (page 18)



Blu-ray Disc™ player, cable box, satellite box, etc.

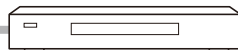

TV connection: Refer to "Startup Guide" (separate document).

"Connecting Sony TV with the BLUETOOTH Function Wirelessly" (page 15)



"Operating the Speaker System by Interlocking with a TV (Control for HDMI function)" (page 27)

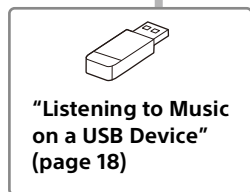

"Listening to Music on a USB Device" (page 18)

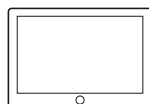
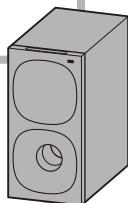

"Listening to Music with the BLUETOOTH® Function" (page 20)



"Connecting the Wireless Amplifier Manually" (page 14)

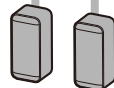
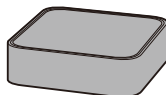

Surround speakers

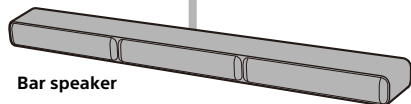

Bar speaker

Guide to Parts and Controls

Subwoofer

Front

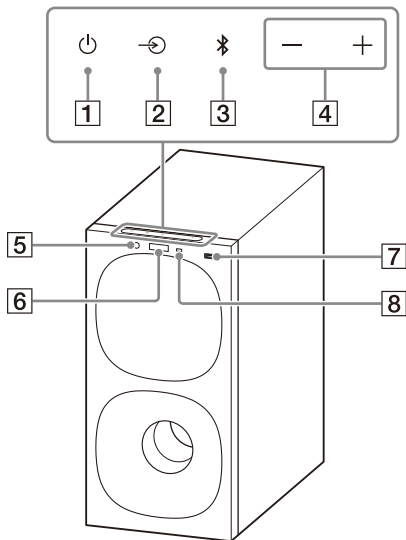

1 **⏻ (power) button**

Turns on the speaker system or sets it to standby mode.

2 **↻ (input select) button**

Selects the input for playback on the speaker system.

3 **BLUETOOTH button (page 20)**

4 **+/- (volume) buttons**

5 **BLUETOOTH indicator**

- Lights in blue: BLUETOOTH connection has been established.
- Flashes slowly in blue repeatedly: BLUETOOTH connection is being attempted.
- Flashes twice in blue repeatedly: During pairing standby status.

6 **Front panel display**

7 **USB (USB) port (page 18)**

8 **Remote control sensor**

Point the remote control at the remote control sensor to operate the speaker system.

Rear

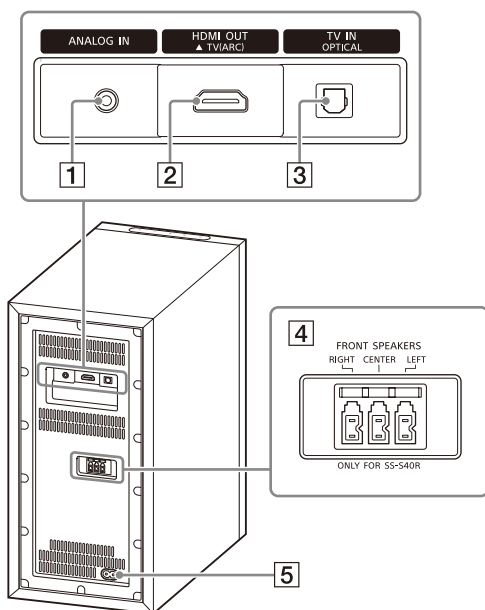

1 ANALOG IN jack

2 HDMI OUT (TV (ARC)) jack

Connect a TV that has an HDMI input jack with an HDMI cable. The speaker system is compatible with Audio Return Channel (ARC). ARC is the function that sends TV sound to an AV device such as the speaker system from the TV's HDMI jack.

3 TV IN (OPTICAL) jack

4 FRONT SPEAKERS jacks

5 AC inlet

Wireless Amplifier

Front

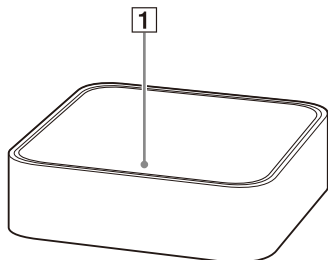

1 Power indicator

Displays the connecting status between the subwoofer and wireless amplifier, and power condition of the wireless amplifier.

Red

– Lights up: The wireless amplifier is in standby mode.

Green

– Lights up: The wireless amplifier is connected to the subwoofer.

– Flashes slowly: The wireless amplifier is attempting to connect to the subwoofer.

Amber

– Lights up: The wireless amplifier is connected to the subwoofer via manual connection.

– Flashes slowly: The wireless amplifier is attempting to connect to the subwoofer via manual connection.

– Flashes twice repeatedly: The wireless amplifier is in pairing

Rear

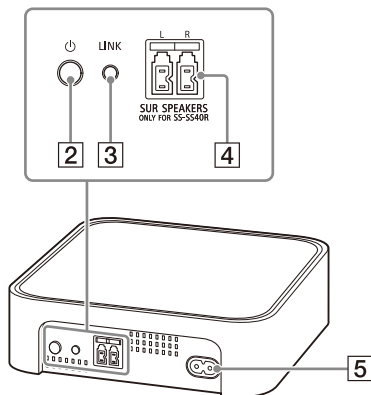

standby status via manual connection.

– Flashes quickly: The software is updating.

Turns off

– The wireless amplifier is turned off.

2 (power) button

Turns on or off the wireless amplifier.

3 LINK button (page 14)

4 SUR SPEAKERS jacks

5 AC inlet

Remote Control

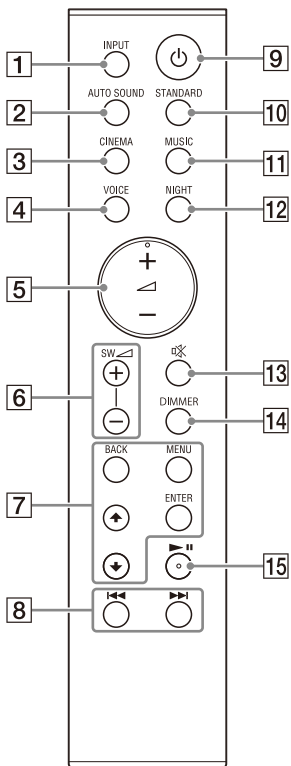

1 INPUT (pages 18, 22, 23)
Selects the input source.
Each time you press INPUT, the input source changes cyclically as follows.
[TV] → [ANALOG] → [BT] → [USB]

2 AUTO SOUND (page 24)
Selects AUTO SOUND for the sound mode.

3 CINEMA (page 24)
Selects CINEMA for the sound mode.

4 VOICE (page 25)
Turns on/off the voice mode.

5 \triangle (volume) +/--
Adjusts the volume.

6 SW \triangle (subwoofer volume) +/--
Adjusts the subwoofer volume.



7 MENU (pages 18, 29)
Turns on/off the setting menu in the front panel display.



\uparrow/\downarrow (pages 18, 29)
Selects the setting menu items.
Selects the content on the TV screen for USB playback.

ENTER (pages 18, 29)
Enters the selection.
Plays the content that is selected by \uparrow/\downarrow for USB playback.

BACK (pages 18, 29)
Returns to the previous display.
Selects the upper layer for USB playback.

8 \lll/\ggg (previous/next) (pages 18, 20)
Selects the previous/next track or file.
Hold down to search backward or forward for USB playback.

- 9**  **(power)**
Turns on the speaker system or sets it to standby mode.
- 10** **STANDARD (page 24)**
Selects STANDARD for the sound mode.
- 11** **MUSIC (page 24)**
Selects MUSIC for the sound mode.
- 12** **NIGHT (page 25)**
Turns on/off the night mode.
- 13**  **(muting)**
Mutes the sound temporarily. Pressing the button while muting cancels muting.
- 14** **DIMMER (page 33)**
- 15**  *** (play/pause) (pages 18, 20)**
Plays, pauses, or resumes playback.

* The  and  buttons have a tactile dot. Use it as a guide during operation.

About the replacement of batteries for the remote control

When the speaker system does not respond by operating with the remote control, replace two batteries with new batteries.

Use R03 (size AAA) manganese batteries for replacement.

Basic Installation and Connection

Refer to Startup Guide (separate document).

Mounting the Speaker System on a Wall

You can mount the bar speaker, surround speakers, and wireless amplifier on a wall.

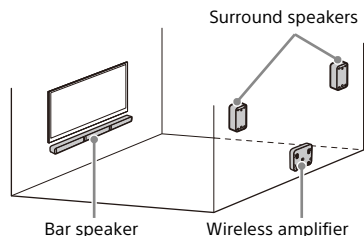

Notes

- Prepare screws (not supplied) that are suitable for the wall material and strength. As a plasterboard wall is especially fragile, attach the screws securely in the wall beam. Install the speakers or wireless amplifier horizontally, hung by screws in studs in a continuous flat section of the wall.
- Have the installation done by a Sony dealer or licensed contractor and pay special attention to safety during the installation.
- Sony shall not be held responsible for accidents or damage caused by improper installation, insufficient wall strength, improper screw installation or natural disaster, etc.

Mounting the Bar Speaker on a Wall

- 1 Prepare two screws (not supplied) that are suitable for the wall mount holes on the rear of the bar speaker.

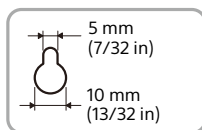
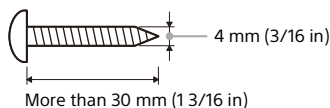

Hole on the rear of the bar speaker

- 2 Stick WALL MOUNT TEMPLATE (supplied) on a wall.

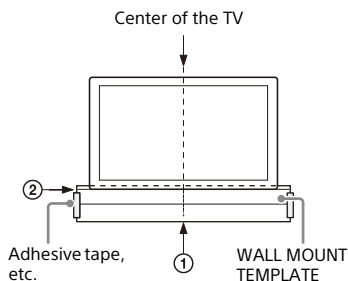

- 1 Align TV CENTER LINE (①) of WALL MOUNT TEMPLATE with the center line of your TV.
- 2 Align TV BOTTOM LINE (②) of WALL MOUNT TEMPLATE with the bottom of your TV, then stick WALL MOUNT TEMPLATE on a wall by using a commercially available adhesive tape, etc.

- 3** Fasten the screws into the marks (Ⓢ) on SCREW LINE (③) of WALL MOUNT TEMPLATE as in the illustration below.

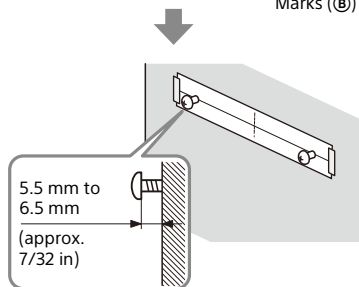
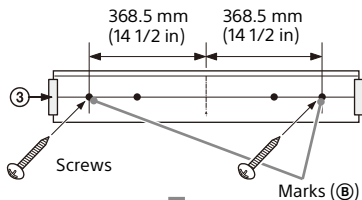

- 4** Remove WALL MOUNT TEMPLATE.

- 5** Hang the bar speaker on the screws.

Align the holes on the rear of the bar speaker with the screws, then hang the bar speaker on the two screws.

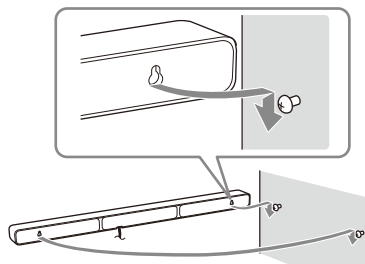

Note

When sticking WALL MOUNT TEMPLATE, smooth it out fully.

Mounting the Surround Speakers on a Wall

- 1** Prepare a screw (not supplied) for each speaker that is suitable for the wall mount hole on the rear of the surround speaker.

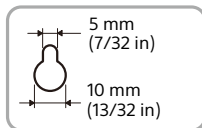
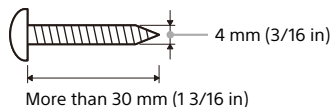

Hole on the rear of the surround speaker

- 2** Fasten the screw on a wall as in the illustration below.

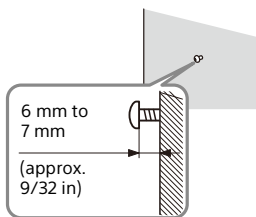

- 3** Hang the surround speaker on the screw.

Align the hole on the rear of the surround speaker with the screw, then hang the surround speaker on the screw.

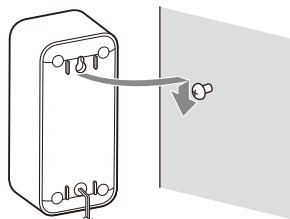

Mounting the Wireless Amplifier on a Wall

- 1 Prepare two screws (not supplied) that are suitable for the wall mount holes on the bottom of the wireless amplifier.**

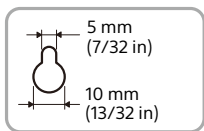
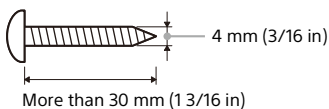

Hole on the bottom of the wireless amplifier

- 2 Fasten the screws on a wall as in the illustration below.**

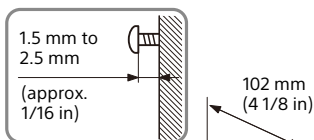

Attach the screws apart from the floor at more than 170 mm (6 3/4 in) so that the AC power cord (mains lead) can be attached to the wireless amplifier.

- 3 Hang the wireless amplifier on the screws.**

Align the holes on the bottom of the wireless amplifier with the screws, then hang the wireless amplifier on the two screws.

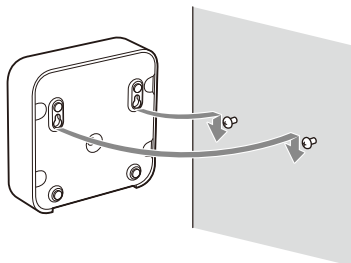

Connecting the Wireless Amplifier Manually

The wireless amplifier is connected to the subwoofer automatically when they are turned on.

If you cannot connect the wireless amplifier to the subwoofer automatically, or you use multiple wireless products and want to specify the subwoofer that is connected wirelessly to the wireless amplifier, perform the manual connection.

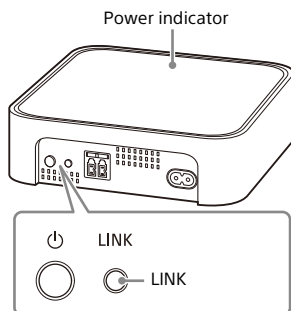
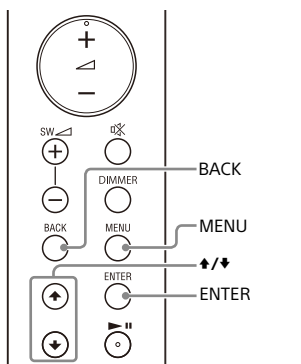

- 1 Press MENU.**
[CURRENT STATUS] appears in the front panel display.
- 2 Press $\blacktriangle/\blacktriangledown$ to select [SPEAKER], then press ENTER.**
- 3 Press $\blacktriangle/\blacktriangledown$ to select [LINK], then press ENTER.**
- 4 Press $\blacktriangle/\blacktriangledown$ to select [START], then press ENTER.**
[LINK] flashes in the front panel display.
To cancel the manual connection, press BACK.
- 5 Press LINK on the wireless amplifier.**
The manual link starts.
The power indicator of the wireless amplifier flashes twice in amber repeatedly.
- 6 When [DONE] appears in the front panel display, press MENU.**
The link is established and the power indicator of the wireless amplifier lights in amber.

Note

If [ERROR] appears in the front panel display, the connection of the wireless amplifier has not been established. Perform the manual connection again.

Connecting Sony TV with the BLUETOOTH Function Wirelessly

When using Sony TV* with the BLUETOOTH function, you can listen to sound of the TV or device that is connected to the TV by connecting the speaker system and TV wirelessly.

* The TV needs to be compatible with A2DP (Advanced Audio Distribution Profile) of the BLUETOOTH profile.

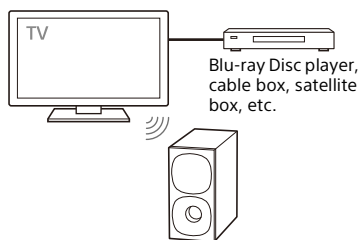

Note

If connecting the speaker system and TV by using the BLUETOOTH function, you cannot display the USB playback screen on the TV screen.

To use all the functions of the speaker system, connect the speaker system and TV with an HDMI cable. For details about connections and operations to listen to TV sound by connecting with an HDMI cable, refer to Startup Guide (separate document).

Listening to TV Sound by Connecting the Speaker System and TV Wirelessly

You need to perform pairing of the speaker system and TV by using the BLUETOOTH function.

Pairing is the process required to mutually register the information on BLUETOOTH devices to be connected wirelessly in advance.

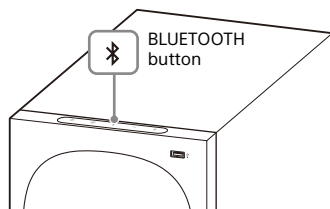
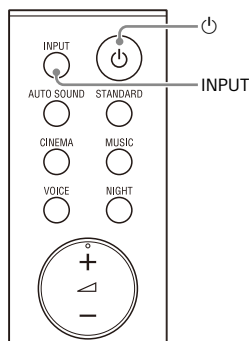

- 1 Turn on the TV.
- 2 Turn on the speaker system.
- 3 Press and hold the BLUETOOTH button on the subwoofer and INPUT on the remote control simultaneously for 5 seconds.

The speaker system enters the pairing mode, [PAIRING] appears in the front panel display, and the BLUETOOTH indicator flashes twice in blue repeatedly.

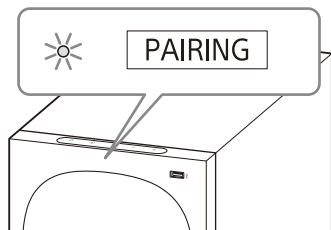

4 On the TV, search the speaker system by performing the pairing operation.

The list of the BLUETOOTH devices that are searched appears on the TV screen.

For the operation method to pair the BLUETOOTH device to the TV, refer to the operating instructions of the TV.

5 Pair the speaker system and TV by selecting "HT-S40R" from the list on the TV screen.

6 Make sure that the BLUETOOTH indicator on the subwoofer lights in blue and [TV-BT] appears in the front panel display.

A connection between the speaker system and TV has been established.

7 Select the program or input of the device by using the TV remote control.

The sound of the displayed image on the TV screen is output from the speaker system.

8 Adjust the volume of the speaker system by using the TV remote control.

When pressing the muting button on the TV remote control, the sound is muted temporarily.

Notes

- If the TV sound is not output from the speaker system, select the TV input by pressing INPUT and check the status of the front panel display and indicators on the subwoofer.
 - [TV-BT] appears in the front panel display: The speaker system and TV are connected and TV sound is output from the speaker system.
 - The BLUETOOTH indicator flashes twice repeatedly and [PAIRING] appears in the front panel display: Perform pairing on the TV.
 - [TV] appears in the front panel display: Perform steps from the start.
- When you connect the speaker system and TV with an HDMI cable, the BLUETOOTH connection is canceled. To connect the speaker system and TV with the BLUETOOTH function again, disconnect the HDMI cable, then perform the connecting operation from the start.
- While the speaker system is connecting the TV with the BLUETOOTH function and [AUTO SOUND] is selected for the sound mode, [STANDARD] is selected for the sound mode.

Listening to Sound of the Paired TV

You can turn the speaker system on/off, adjust the volume, and mute the sound by using the TV remote control when connecting the TV to the speaker system wirelessly.

1 Turn on the TV with the TV remote control.

The speaker system is turned on by interlocking with the TV power, and TV sound is output from the speaker system.

2 Select the program or input of the device by using the TV remote control.

The sound of the displayed image on the TV screen is output from the speaker system.

3 Adjust the volume of the speaker system by using the TV remote control.

When pressing the muting button on the TV remote control, the sound is muted temporarily.

Note

If you select the input other than [TV] on the remote control supplied with the speaker system, the TV sound is not output from the speaker system. To output the TV sound, select the TV input by pressing INPUT.

Tip

When the TV is turned off, the speaker system is also turned off by interlocking with the TV power.

Listening to a TV

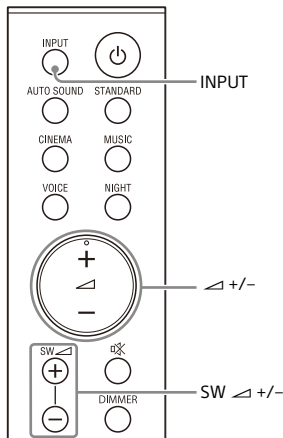

1 Press **INPUT** repeatedly to select [TV] in the front panel display.

2 Adjust the volume.

- Adjust the volume by pressing \triangle +/-.
- Adjust the subwoofer volume by pressing SW \triangle +/-.

Notes

- When you connect the TV to both the HDMI OUT (TV (ARC)) and TV IN (OPTICAL) jacks, the jack for audio input is selected depending on which audio signal is input first.
- When the input source does not contain much bass sound, such as in TV programs, the bass sound from the subwoofer may be difficult to hear.

Tip

You can also select the input by pressing ⌂ on the subwoofer.

Listening to Music on a USB Device

Notes

- To view the USB content list on the TV screen, make sure you connect the speaker system to the TV using an HDMI cable.
- Change the input of the TV to the input to which the speaker system is connected.

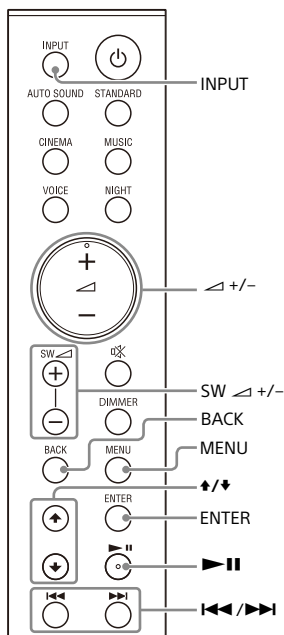

- 1 **Connect the USB device to the (USB) port.**

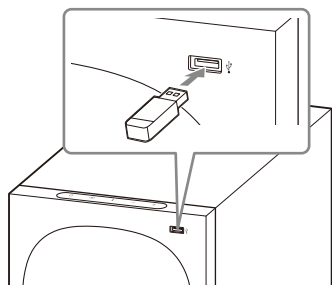

- 2 **Press INPUT repeatedly to select [USB] in the front panel display.**
[READ] appears in the front panel display and the speaker system starts reading data of the USB device. When the reading of data is completed, the USB content list appears on the TV screen.
- 3 **Press $\blacktriangleleft/\blacktriangleright$ to select the content you want, then press ENTER.**
The selected content starts playing. You can go to the upper layer by pressing BACK.
- 4 **Adjust the volume.**
 - Adjust the volume by pressing \blacktriangleleft +/-.
 - Adjust the subwoofer volume by pressing SW \blacktriangleleft +/-.

Note

When the input source does not contain much bass sound, such as in TV programs, the bass sound from the subwoofer may be difficult to hear.

To select the play mode

You can select the play mode for USB playback, such as repeat play or random play, from the setting menu.

- 1 **Press MENU.**
[CURRENT STATUS] appears in the front panel display.
- 2 **Press $\blacktriangleleft/\blacktriangleright$ /ENTER to select [USB] - [REPEAT].**
- 3 **Press $\blacktriangleleft/\blacktriangleright$ /ENTER to select the play mode.**
 - [OFF]: Repeat off. Plays back all tracks.
 - [ONE]: Repeats one track.
 - [FOLDER]: Repeats all tracks in the current folder.
 - [RANDOM]: Repeats all tracks in the current folder in random order.
 - [ALL]: Repeats all tracks.
- 4 **Press MENU to exit the setting menu.**

Other operations

To	Do this
Pause or resume playback	Press $\blacktriangleright\ \blacktriangleleft$.
Select the previous or next track	Press $\blacktriangleleft\blacktriangleleft/\blacktriangleright\blacktriangleright$.
Search backward or forward (rewind/fast forward)	Press and hold $\blacktriangleleft\blacktriangleleft/\blacktriangleright\blacktriangleright$.

Notes

- Do not remove the USB device during operation. To avoid data corruption or damage to the USB device, turn the speaker system off before connecting or removing the USB device.
- [INVALID USB] appears in the front panel display if you connect an unsupported or broken USB device.
- Depending on the file format, rewind and fast forward may not work.

Information of USB Device on the TV Screen

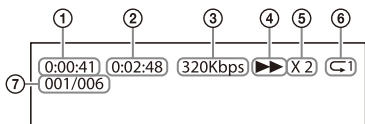

- ① Playing time
- ② Total playing time
- ③ Bit rate
- ④ Playback status
- ⑤ Rewind/fast forward speed
- ⑥ Play mode
- ⑦ Selected file index/Total files in the folder

The following messages appear on the TV screen depending on the status of the USB device.

- [File Unsupported]
Appears for 2 seconds at the bottom left side when an unsupported file is skipped.
- [Device Not Support]
 - A USB device is not supported.
 - Device inserted is a non-USB device, a bad USB device, or a USB device that has no files on it.
- [No USB]
No USB device is inserted.
- [Waiting]
The speaker system is searching the USB device.
- [This device is empty]
There are no playable files in the USB device.

Notes

- Depending on the playback source, some information may not be displayed.
- Depending on the play mode, the information displayed may differ.

Listening to Music with the BLUETOOTH® Function

Listening to Music by Pairing the Mobile Device that is Connected for the First Time

To use the BLUETOOTH function, you need to perform pairing of the speaker system and mobile device in advance.

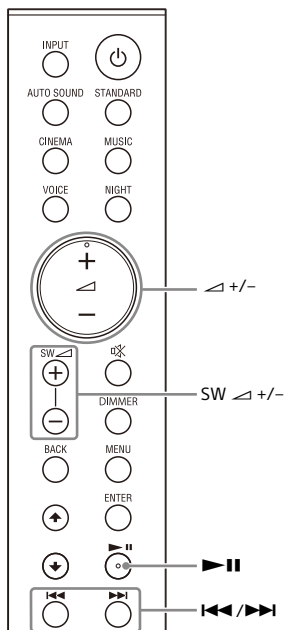

1 Press and hold the BLUETOOTH button on the subwoofer for 2 seconds.

The speaker system enters the pairing mode, [PAIRING] appears in the front panel display, and the BLUETOOTH indicator flashes twice in blue repeatedly.

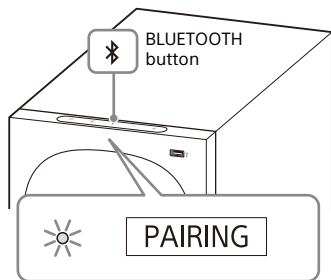

2 On the mobile device, search for the speaker system by performing the pairing operation.

The list of the BLUETOOTH devices that are searched appears on the screen of the mobile device. For the operation method to pair the BLUETOOTH device to the mobile device, refer to the operating instructions of the mobile device.

3 Pair the speaker system and mobile device by selecting "HT-S40R" from the list on the screen of the mobile device.

If a Passkey is requested, enter "0000."

4 Make sure that the BLUETOOTH indicator on the subwoofer lights in blue and [BT] appears in the front panel display.

A connection between the speaker system and mobile device has been established.

5 Start audio playback with the music app on the connected mobile device.

Sound is output from the speaker system.

6 Adjust the volume.

- Adjust the volume by pressing \triangle +/-.
- Adjust the subwoofer volume by pressing SW \triangle +/-.
- $\blacktriangleright\|\blacktriangleleft$ and $\blacktriangleleft\|\blacktriangleright$ can be used for the BLUETOOTH function. (Searching backward or forward by holding down $\blacktriangleleft\|\blacktriangleright$ does not work.)

Notes

- You can pair the BLUETOOTH devices up to the following number.
 - Mobile devices: 9
 - Sony TV with the BLUETOOTH function: 1If a new device is paired after pairing the above number of devices, the oldest connected device will be replaced by the new one.
- Perform pairing for the second and subsequent mobile devices.
- When the input source does not contain much bass sound, such as in TV programs, the bass sound from the subwoofer may be difficult to hear.

Tips

- You can check the connection status of the BLUETOOTH function by checking the BLUETOOTH indicator status.
- While the BLUETOOTH input is being selected, the speaker system enters the pairing mode by pressing the BLUETOOTH button on the subwoofer shortly.

Listening to Music from the Paired Device

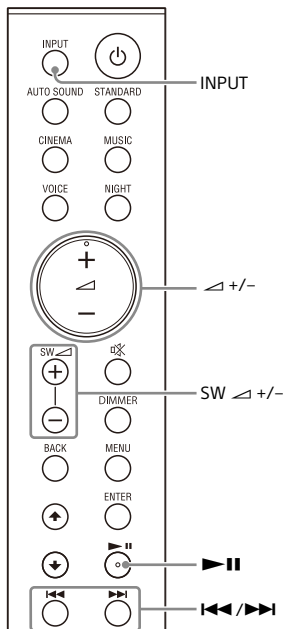

1 Turn the **BLUETOOTH** function of the mobile device on.

2 Press **INPUT** repeatedly to select **[BT]** or shortly press the **BLUETOOTH** button on the subwoofer.

The **BLUETOOTH** indicator flashes and the speaker system automatically reconnects to the **BLUETOOTH** device it was most recently connected to.

3 Make sure that the **BLUETOOTH** indicator lights in blue.

A connection between the speaker system and mobile device has been established.

4 Start audio playback with the music app on the connected mobile device.

Sound is output from the speaker system.

5 Adjust the volume.

- Adjust the volume by pressing \triangleleft +/-.
- Adjust the subwoofer volume by pressing **SW** \triangleleft +/-.
- **▶▶||** and **◀◀/▶▶** can be used for the **BLUETOOTH** function. (Searching backward or forward by holding down **◀◀/▶▶** does not work.)

Note

When the input source does not contain much bass sound, such as in TV programs, the bass sound from the subwoofer may be difficult to hear.

Tip

When the connection is not established, select "HT-S40R" on the mobile device.

To disconnect the mobile device

Perform any of the following items.

- Disable the **BLUETOOTH** function on the mobile device.
- Set **[BT]** - **[POWER]** to **[OFF]** (page 31).
- Turn off the speaker system or mobile device.

Listening to Music on an Audio Device Connected with a Stereo Mini Cable

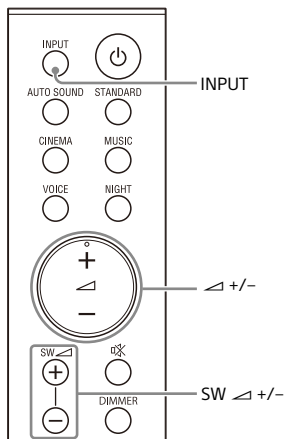

- 1** Connect an audio device to the **ANALOG IN** jack.

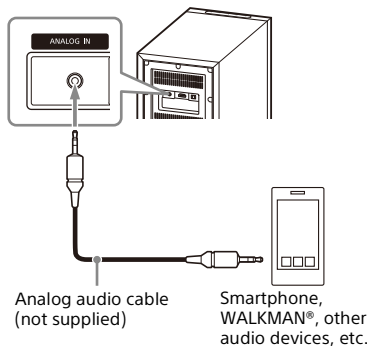

- 2** Press **INPUT** repeatedly to select **[ANALOG]** in the front panel display.

- 3** Start music playback by operating the connected audio device.

Sound is output from the speaker system.

- 4** Adjust the volume.

- Adjust the volume by pressing **+/-**.
- Adjust the subwoofer volume by pressing **SW +/-**.

Note

When the input source does not contain much bass sound, such as in TV programs, the bass sound from the subwoofer may be difficult to hear.

Adjusting the Sound Quality

Setting the Sound Effect that is Tailored to Sound Sources (Sound Mode)

You can easily enjoy pre-programmed sound effects that are tailored to different kinds of sound sources.

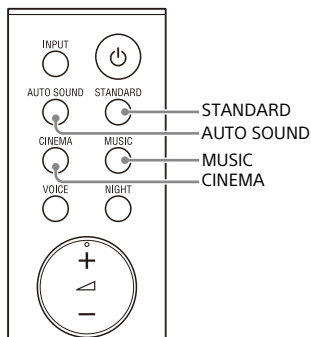

- 1 Press one of the sound mode selecting buttons (AUTO SOUND, STANDARD, CINEMA, MUSIC) to select the sound mode.**

Button	Function
AUTO SOUND	[AUTO SOUND] appears in the front panel display. The appropriate sound mode setting is automatically selected from STANDARD, CINEMA, or MUSIC.
STANDARD	[STANDARD] appears in the front panel display. Sound effects are optimized for the individual source.

Button	Function
CINEMA	[CINEMA] appears in the front panel display. Sounds are played back with surround effects, and they are realistic and powerful, making them suitable for movies.
MUSIC	[MUSIC] appears in the front panel display. Sound effects are optimized for listening to music.

Making Dialogs Clearer (VOICE)

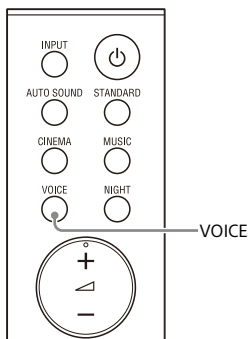

- 1 Press **VOICE** to set the function on or off.

Front panel display	Function
[Vo.ON]	Dialog is easily heard by enhancing dialog range.
[Vo.OFF]	Deactivates the voice mode function.

Enjoying Clear Sound with Low Volume at Midnight (NIGHT)

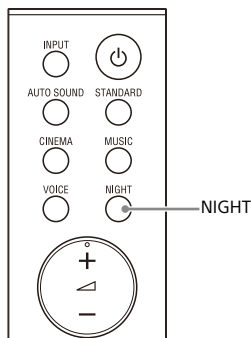

- 1 Press **NIGHT** to set the function on or off.

Front panel display	Function
[N.ON]	Outputs the sound at low volume with minimum loss of fidelity and clarity of dialog.
[N.OFF]	Deactivates the night mode function.

Note

When you turn the speaker system off, this setting is set to [N.OFF] automatically.

Checking the Current Sound Settings

You can check the settings of the sound, night, and voice modes and current stream information.

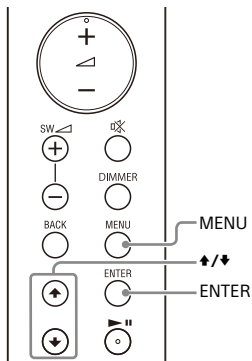

- 1 Press MENU.**
[CURRENT STATUS] appears in the front panel display, then press ENTER.
- 2 Press ↓ repeatedly to select the item you want.**
The current setting appears in the following order.
Sound mode → Voice mode → Night mode → Stream Information
The current setting appears in the reverse order by pressing ↑.
- 3 Press MENU to exit the setting menu.**

Using the Speaker System by Interlocking with a TV

Operating the Speaker System by Interlocking with a TV (Control for HDMI function)

Connecting a TV compatible with the Control for HDMI function using an HDMI cable enables you to interlock the speaker system operation such as power on/off or volume adjustment with a TV.

About the Control for HDMI function

The Control for HDMI function is a function that enables operation of devices connected with an HDMI (High-Definition Multimedia Interface) cable by interlocking each other.

Although this function works for devices compatible with the Control for HDMI function, it may not work if connecting devices other than those manufactured by Sony.

Preparing to Operate by Interlocking with a TV

Enable the Control for HDMI function settings of the TV connected to the speaker system with an HDMI cable. The default setting of the Control for HDMI function of the speaker system is [ON] (page 31).

Tips

- When connecting a device such as a Blu-ray Disc player to a TV with an HDMI cable, enable its Control for HDMI function.
- To enable the Control for HDMI function of a TV or Blu-ray Disc player, refer to their operating instructions.

- If you enable the Control for HDMI ("BRAVIA" sync) function when using a TV manufactured by Sony, the Control for HDMI function of the speaker system is also enabled automatically.

Performing Power Operation or Volume Adjustment by a TV Remote Control

When performing TV power operation or volume adjustment by a TV remote control, the speaker system power operation or volume adjustment is interlocked.

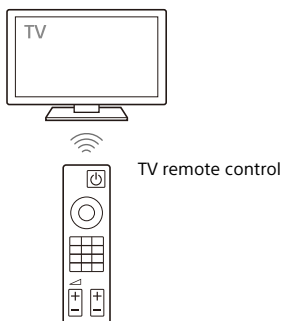

Power interlocking

When you turn on or off the TV, the speaker system will turn on or off automatically.

Note

If you turn off the speaker system before turning off the TV, the speaker system may not turn on automatically even though you turn on the TV next time. In this case, perform the following operation.

- Select the speaker system for the sound output device in the TV menu.
- When using Sony TV, turn on the speaker system while the TV is turned on.

Volume adjustment

The TV sound that you are watching is output from the speaker system automatically. You can adjust the speaker system volume by the TV remote control.

Other Interlocking Function

One-Touch Play Function

When you play content on a Blu-ray Disc player or "PlayStation®4," etc. connected to the TV, the speaker system and TV are turned on automatically.

Tip

You can change the Control for HDMI function setting on [HDMI] - [CONTROL FOR HDMI] (page 31) in the setting menu.

Using the Setting Menu

You can set the following items with the setting menu. Your settings are retained even if you disconnect the AC power cord (mains lead).

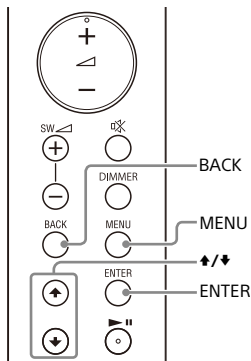

- 1 Press MENU to enter the setting menu mode.**
The setting menu item appears in the front panel display.
- 2 Press \uparrow/\downarrow repeatedly to select the item, then press ENTER.**
You can select the following items.
 - [CURRENT STATUS] (Checking the current status) (page 30)
 - [SPEAKER] (Speaker settings) (page 30)
 - [AUDIO] (Audio settings) (page 31)
 - [HDMI] (HDMI settings) (page 31)
 - [BT] (BLUETOOTH settings) (page 31)
 - [USB] (USB settings) (page 31)
 - [SYSTEM] (Speaker system settings) (page 32)
 - [RESET] (Resetting the speaker system) (page 32)
 - [UPDATE] (Updating the speaker system) (page 32)
- 3 Press \uparrow/\downarrow repeatedly to select the setting, then press ENTER.**
To return to the upper layer, press BACK.
- 4 Press MENU to exit the setting menu mode.**

Setting menu items

Items	Function	
[CURRENT STATUS] (Checking the current status)	<p>[AUTO SOUND]/ [STANDARD]/ [CINEMA]/[MUSIC] (Sound mode)</p> <p>[Vo. ON]/[Vo.OFF] (Voice mode)</p> <p>[N.ON]/[N.OFF] (Night mode)</p> <p>[NO INFO.]/ [LPCM]/ [DOLBY DIGITAL] (Stream information)</p>	<p>These items are not setting menu items. You can check the settings of the sound, night, and voice modes and current stream information. For details about operation, see "Checking the Current Sound Settings" (page 26).</p>
[SPEAKER] (Speaker settings)	<p>[MULTI SPEAKER]</p> <ul style="list-style-type: none"> • [ON]: Outputs the sound from all the speakers, regardless of the number of audio channels for the playback source. • [OFF]: Outputs the sound from the speakers that correspond to the audio channel for the playback source. <p>[SUR.L.DISTANCE]/ [SUR.R.DISTANCE] (Surround speaker distance)</p> <p>Adjusts the distance from the seating position to the surround speaker (left or right) from 1.0 meter to 6.0 meters (0.1 meter intervals) (from 3.0 feet to 20.0 feet (3 inch intervals)).</p> <p>Note You can change measurement units (meters or feet) on [DISTANCE UNIT].</p> <p>[DISTANCE UNIT]</p> <p>Changes measurement units (meters or feet) for [SUR.L.DISTANCE]/[SUR.R.DISTANCE].</p> <ul style="list-style-type: none"> • [METER]: Meter display. • [FEET]: Feet display. <p>[SUR.L.LEVEL]/ [SUR.R.LEVEL] (Surround speaker level)</p> <p>Adjusts the sound level of the surround speaker (left or right) from -6.0 dB to +6.0 dB (0.5 dB intervals).</p> <p>Note Be sure to set [TEST TONE] to [ON] for easy adjustment.</p> <p>[TEST TONE]</p> <p>[ON]: Outputs the test tone from each speaker in sequence. [OFF]: Turns off the test tone.</p> <p>Note The test tone is not output even though [TEST TONE] is set to [ON] while the [USB] input is selected. Select an input other than [USB].</p> <p>[LINK]</p> <ul style="list-style-type: none"> • [START]: Performs the manual connection of the wireless amplifier to the subwoofer. For details, see "Connecting the Wireless Amplifier Manually" (page 14). To cancel the manual connection, press BACK. • [CANCEL]: Returns to the upper layer [LINK]. 	

Items	Function	
[AUDIO] (Audio settings)	[DRC] (Dynamic range control)	Useful for enjoying movies at low sound volume. DRC applies to Dolby Digital sources. <ul style="list-style-type: none"> • [ON]: Compresses sound according to the information in the content. • [OFF]: Sound is not compressed.
	[A.VOL] (Auto volume)	Adjusts the volume automatically depending on the input level from a connected device. <ul style="list-style-type: none"> • [ON]: Adjusts the volume automatically. • [OFF]: Off.
	[DUAL] (Dual mono)	You can enjoy multiplex broadcast sound when the speaker system receives a Dolby Digital multiplex broadcast signal. <ul style="list-style-type: none"> • [MAIN]: Sound of the main language will be output. • [SUB]: Sound of the sub language will be output. • [M/S]: Mixed sound of both the main and sub languages will be output. <p>Note To receive a Dolby Digital signal, you need to connect a TV or other device to the TV IN (OPTICAL) jack with an optical digital cable or the HDMI OUT (TV (ARC)) jack with an HDMI cable.</p>
[HDMI] (HDMI settings)	[CONTROL FOR HDMI]	<ul style="list-style-type: none"> • [ON]: Enables the Control for HDMI function. Devices connected with an HDMI cable can operate each other. • [OFF]: Disables the Control for HDMI function.
	[TV AUDIO]	You can set whether the playback sound is input from an HDMI cable or optical digital cable. <ul style="list-style-type: none"> • [AUTO]: Plays the sound that is detected from either an HDMI cable or optical digital cable. When you connect either an HDMI cable or optical digital cable, the speaker system plays by selecting the connected cable for the TV input. • [OPTICAL]: Plays the sound from the TV IN (OPTICAL) jack for the TV input.
[BT] (BLUETOOTH settings)	[POWER]	<ul style="list-style-type: none"> • [ON]: Turns the BLUETOOTH function on. • [OFF]: Turns the BLUETOOTH function off. <p>Note When the BLUETOOTH function is set to off, the BLUETOOTH input is skipped while selecting input by pressing INPUT.</p>
	[STANDBY]	When the speaker system has pairing information, you can turn the speaker system on and listen to music from a BLUETOOTH device, even when the speaker system is in standby mode, by setting the BLUETOOTH standby mode to on. <ul style="list-style-type: none"> • [ON]: Enables the BLUETOOTH standby mode. • [OFF]: Disables the BLUETOOTH standby mode. <p>Note While the BLUETOOTH standby mode is on, standby power consumption increases.</p>
[USB] (USB settings)	[REPEAT] (Repeat play mode)	<ul style="list-style-type: none"> • [OFF]: Repeat off. Plays back all tracks. • [ONE]: Repeats one track. • [FOLDER]: Repeats all tracks in the current folder. • [RANDOM]: Repeats all tracks in the current folder in random order. • [ALL]: Repeats all tracks.

Items	Function	
[SYSTEM] (Speaker system settings)	[AUTO STANDBY]	<ul style="list-style-type: none"> • [ON]: Turns on the auto standby function. When you do not operate the speaker system for about 20 minutes, the speaker system enters standby mode automatically. • [OFF]: Off.
	[VERSION] (Version information)	The current firmware version information of the speaker system appears in the front panel display.
	[SUR. AMP. INFO] (Wireless amplifier version information)	<ul style="list-style-type: none"> • [LATEST]: The wireless amplifier is the latest version. • [PLEASE UPDATE]: The wireless amplifier is not the latest version. • [NOT CONNECTED]: The wireless amplifier is not connected to the subwoofer.
[RESET] (Resetting the speaker system)	[ALL RESET]	You can reset the speaker system settings to the factory default. For details, see "Resetting the Speaker System" (page 40).
[UPDATE] (Updating the speaker system)	[START]	<p>You can start software update after connecting the USB memory on which the software update file is stored to the speaker system. When there is a software update available, we will notify you on the following website:</p> <ul style="list-style-type: none"> • For customers in Americas https://www.sony.com/am/support • For customers in Europe https://www.sony.eu/support • For customers in Asia-Pacific, Oceania, Middle East, and Africa https://www.sony-asia.com/support <p>Note Before updating, make sure that the wireless amplifier is turned on and connected to the subwoofer.</p>
	[CANCEL]	Returns to the upper layer [UPDATE].

Changing the Brightness of the Front Panel Display and Indicators (DIMMER)

You can change the brightness of the following.

- Front panel display
- BLUETOOTH indicator
- Power indicator on the wireless amplifier

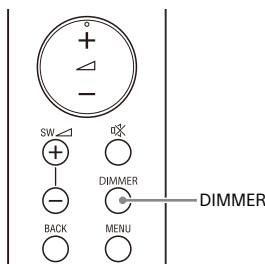

- 1 Press **DIMMER** repeatedly to select the desired setting.

Front panel display	Function
[BRIGHT]	The front panel display and indicators light brightly.
[DARK]	The front panel display and indicators light darkly.
[OFF]	The front panel display is turned off.

Note

The front panel display is turned off when [OFF] is selected. It turns on automatically when you press any button, then turns off again if you do not operate the speaker system for about 10 seconds. However, in some cases, the front panel display may not turn off. In this case, the brightness of the front panel display is same as [DARK].

Saving Power Consumption

To use the speaker system with saving power consumption, change the following settings.

Turning the Speaker System Off by Detecting the Using State

When you set the auto standby function to on, the speaker system enters standby mode automatically when you do not operate the speaker system for about 20 minutes and the speaker system is not receiving an input signal.

- 1 Set [SYSTEM] - [AUTO STANDBY] to [ON].

Saving Power in Standby Mode

To save power consumption during the standby mode, set [BT] - [STANDBY] to [OFF] (page 31).

Troubleshooting

If the speaker system does not work properly, handle it in the following order.

- 1 Search for the cause and solution of the issue using this troubleshooting.
- 2 Reset the speaker system.
All the settings of the speaker system return to their initial status. For details, see "Resetting the Speaker System" (page 40).

Should any problems persist, consult your nearest Sony dealer.

Be sure to bring your bar speaker, subwoofer, wireless amplifier, and surround speakers even if it seems as though only one has a problem, when you request to repair.

Power

The speaker system does not power up.

- Check that the AC power cord (mains lead) is connected securely.
- Disconnect the AC power cord (mains lead) from the wall outlet (mains), and then reconnect after several minutes.

The speaker system is turned off automatically.

- The auto standby function is working.
Set [SYSTEM] - [AUTO STANDBY] to [OFF] (page 32).

The speaker system does not turn on even when the TV is turned on.

- Set [HDMI] - [CONTROL FOR HDMI] to [ON] (page 31). The TV must support the Control for HDMI function. For details, refer to the operating instructions of your TV.

- Check the speaker settings of the TV. The speaker system power syncs with the speaker settings of the TV. For details, refer to the operating instructions of your TV.
- Depending on the TV, if the sound was output from the speakers of the TV the previous time, the speaker system may not turn on by interlocking with the TV power even when the TV is turned on.

The speaker system turns off when the TV is turned off.

- Check the setting of the Control for HDMI function (page 31). When the Control for HDMI function is set to on and the input of the speaker system is the TV input, the speaker system turns off automatically when you turn off the TV.

The speaker system does not turn off even when the TV is turned off.

- Check the setting of the Control for HDMI function (page 31). When you turn off the TV, the speaker system turns off automatically only if the input of the speaker system is TV input. The TV must support the Control for HDMI function. For details, refer to the operating instructions of your TV.

Picture

There is no picture or the picture is not output correctly.

- Select the appropriate input.
- When there is no picture while the TV input is selected, select the TV channel that you want using the TV remote control.
- Disconnect an HDMI cable, then connect it again. Make sure that the cable is firmly inserted.

Sound

The speaker system cannot connect to a TV with the BLUETOOTH function.

- When you connect the speaker system and TV with an HDMI cable, the BLUETOOTH connection is canceled. Disconnect the HDMI cable, then perform the connecting operation from the start (page 15).

No TV sound is output from the speaker system.

- Check the type and connection of an HDMI cable or optical digital cable that is connected to the speaker system and the TV (refer to the supplied Startup Guide).
- Disconnect the cables that are connected between the TV and the speaker system, then connect them firmly again. Disconnect the AC power cords (mains leads) of the TV and the speaker system from the wall outlets (mains), then connect them again.
- When the speaker system and TV are connected with an HDMI cable only, check the following.
 - The HDMI jack of the connected TV is labeled with “ARC.”
 - The Control for HDMI function of the TV is set to on.
 - The ARC function of the TV is enabled.
 - On the speaker system, the Control for HDMI function is set to on (page 31).
- If your TV is not compatible with Audio Return Channel, connect an optical digital cable (refer to the supplied Startup Guide). If the TV is not compatible with Audio Return Channel, TV sound will not be output from the speaker system even if the speaker system is connected to the TV's HDMI IN jack.

- If the sound of the device that is connected to an optical input jack of the TV is not output, try the following.
 - Connect the cable box or satellite box directly to the TV IN (OPTICAL) jack of the speaker system.
- Press INPUT repeatedly to select the TV input (page 18).
- Increase the volume on the TV or cancel muting.
- Depending on the order in which you turn on the TV and speaker system, the speaker system may be muted. If this happens, turn on the TV first, then the speaker system.
- Set the speaker setting of the TV (BRAVIA) to Audio System. Refer to the operating instructions of your TV regarding how to set the TV.
- Check the sound output of the TV. Refer to the operating instructions of the TV for the TV settings.
- The speaker system supports the Dolby Digital and PCM audio formats. When you play back an unsupported format, set the digital audio out setting of the TV (BRAVIA) to “PCM.” For details, refer to the operating instructions of your TV.

The sound is output from both the speaker system and TV.

- Change the audio output setting of the TV so that the TV sound is output from the external speaker.
- Set the TV volume to minimum.

No sound or only a very low-level sound is heard from the subwoofer.

- Make sure the AC power cord (mains lead) of the subwoofer is connected properly (refer to the supplied Startup Guide).
- Press SW  + on the remote control to increase the subwoofer volume (page 9).
- A subwoofer is for reproducing bass sound. If the input sources contain very little bass sound components (i.e., a TV broadcast), the sound from the subwoofer may be difficult to hear.

- When you play content compatible with copyright protection technology (HDCP), it is not output from the subwoofer.

No sound or only a very low-level sound of the device connected to the speaker system is heard from the speaker system.

- Press \triangleleft + and check the volume level (page 9).
- Press Mute or \triangleleft + to cancel the muting function (page 9).
- Make sure the input source is selected correctly. You should try other input sources by pressing INPUT repeatedly.
- Check that all the cables and cords of the speaker system and connected device are firmly inserted.
- If the connected device supports the up-sampling feature, you need to turn it off.

The surround effect cannot be obtained.

- Depending on the input signal, surround sound processing may not work effectively. The surround effect may be subtle depending on the program or disc.
- To play multi channel audio, check the digital audio output setting on the device connected to the speaker system. For details, refer to the operating instructions of the connected device.

The output sound of the speaker system is not the same level as that of the TV even though the values of the volume level on the speaker system and TV are set to the same value.

- If the Control for HDMI function is set to on, the value of the volume level on the speaker system may appear on your TV as the TV volume. The output sound levels of the speaker system and TV differ even though the values of the volume level on the speaker system and TV are set to the same value. The output sound levels of the

speaker system and TV differ depending on the sound processing characteristics of each, and it is not a malfunction.

The sound is interrupted while watching a TV program or content on a Blu-ray Disc, etc.

- Check the sound mode setting (page 24). If the sound mode is set to [AUTO SOUND], the sound may be interrupted when the sound mode is changed automatically according to the information of the program that is being played. If you do not want to change the sound mode automatically, set the sound mode to a setting other than [AUTO SOUND].

The TV sound from the speaker system lags behind the image.

- A time gap between the sound and picture may occur depending on the sound source. If your TV has a function that delays the image, use it for adjustment.

Wireless Amplifier

No sound or only a very low-level sound is heard from the wireless amplifier.

- Make sure that the power indicator on the wireless amplifier is lit in green or amber.
- If the power indicator on the wireless amplifier does not light, try the following.
 - Make sure the AC power cord (mains lead) of the wireless amplifier is connected properly.
 - Press Power (power) of the wireless amplifier to turn on the power.
- If the power indicator on the wireless amplifier flashes slowly in green or amber, or lights in red, try the following.
 - Move the wireless amplifier to a location near the subwoofer so that

- the power indicator on the wireless amplifier lights in green or amber.
- Follow the steps in "Connecting the Wireless Amplifier Manually" (page 14).
- If the power indicator on the wireless amplifier flashes in red, press  (power) of the wireless amplifier to turn off the power and check whether the ventilation holes of the wireless amplifier is blocked or not.
- Check that [SPEAKER] – [MULTI SPEAKER] is set to [ON] (page 30). If [SPEAKER] – [MULTI SPEAKER] is set to [OFF], the sound is not output from the surround speakers when playing the sound of 2-channel source.

Sound skips or has noise.

- If there is a device nearby that generates electromagnetic waves, such as a wireless LAN or a microwave oven in use, locate the speaker system apart from it.
- If there is an obstacle between the subwoofer and the wireless amplifier, move or remove it.
- Do not cover the top of the subwoofer with metal objects such as TV frame, etc. Wireless functions may become unstable.
- Locate the subwoofer and the wireless amplifier as close to each other as possible.
- Switch the wireless LAN frequency of any nearby wireless LAN router or PC to 5 GHz range.
- Switch the network connection of the TV or Blu-ray Disc player from wireless to wired.

USB Device Connection

The USB device is not recognized.

- Try the following:
 - ① Turn the speaker system off.
 - ② Remove and reconnect the USB device.
 - ③ Turn the speaker system on.

- Make sure that the USB device is securely connected to the  (USB) port.
- Check to see if the USB device or a cable is damaged.
- Make sure that the USB device is on.
- If the USB device is connected via a USB hub, disconnect it and connect the USB device directly to the subwoofer.

Mobile Device Connection

BLUETOOTH connection cannot be completed.

- Make sure that the BLUETOOTH indicator on the subwoofer is lit (page 20).
- Make sure the BLUETOOTH device to be connected is turned on and the BLUETOOTH function is enabled.
- Bring the BLUETOOTH device close to the subwoofer.
- Pair this speaker system and the BLUETOOTH device again. You may need to cancel the pairing with this speaker system using your BLUETOOTH device first.
- If [BT] – [POWER] is set to [OFF], set to [ON] (page 31).

Pairing cannot be achieved.

- Bring the BLUETOOTH device close to the subwoofer.
- Make sure the speaker system is not receiving interference from a wireless LAN device, other 2.4 GHz wireless devices, or a microwave oven. If a device that generates electromagnetic radiation is nearby, move the device away from the speaker system.
- Pairing may not be possible if other BLUETOOTH devices are present around the system. In this case, turn off the other BLUETOOTH devices.

Sound of the connected BLUETOOTH mobile device is not output from the speaker system.

- Make sure that the BLUETOOTH indicator on the subwoofer is lit (page 20).
- Bring the BLUETOOTH device close to the subwoofer.
- If a device that generates electromagnetic radiation, such as a wireless LAN device, other BLUETOOTH devices, or a microwave oven is nearby, move the device away from the speaker system.
- Move the USB 3.0 device and its cable away from this speaker system.
- Remove any obstacle between the speaker system and the BLUETOOTH device or move the speaker system away from the obstacle.
- Reposition the connected BLUETOOTH device.
- Switch the wireless LAN frequency of any nearby wireless LAN router or PC to 5 GHz range.
- Increase the volume on the connected BLUETOOTH device.

The sound is not in sync with the image.

- When you are watching movies, you may hear the sound with a slight delay from the image.

Remote Control

The remote control of this speaker system does not function.

- Point the remote control at the remote control sensor on the subwoofer (page 6).
- Remove any obstacles in the path between the remote control and the subwoofer.
- Replace both batteries in the remote control with new ones, if they are weak.
- Make sure you are pressing the correct button on the remote control.

TV remote control does not work.

- Install the bar speaker so that it does not obstruct the remote control sensor of the TV.

Others

The Control for HDMI function does not work properly.

- Check the connection with the speaker system (refer to the supplied Startup Guide).
- Enable the Control for HDMI function on the TV. For details, refer to the operating instructions of your TV.
- Wait a while, and then try again. If you unplug the speaker system, it will take a while before operations can be made. Wait for 15 seconds or longer, and then try again.
- Make sure the devices connected to the speaker system support the Control for HDMI function.
- Enable the Control for HDMI function of the devices connected to the speaker system. For details, refer to the operating instructions of your device.
- The type and number of devices that can be controlled by the Control for HDMI function are restricted by the HDMI CEC standard as follows:
 - Recording devices (Blu-ray Disc recorder, DVD recorder, etc.): up to 3 devices
 - Playback devices (Blu-ray Disc player, DVD player, etc.): up to 3 devices
 - Tuner-related devices: up to 4 devices
 - Audio system (receiver/headphones): up to 1 device (used by the speaker system)

[PROTECT] appears in the front panel display of the subwoofer, the sound is muted, and buttons on the remote control or subwoofer other than  (power) do not work.

- The protection feature is activated. Press  (power) to turn the speaker system off and disconnect the AC power cord (mains lead) and check the items below.
 - Make sure that the ventilations of the subwoofer are not covered and turn on the speaker system after a while.
 - When the speaker system is using the USB connection, remove the USB device and turn on the speaker system. If the speaker system operates properly, the current of the connected USB device is over the maximum output current of the speaker system 500 mA, or the USB device may have an abnormality.

The front panel display of the subwoofer is not lit.

- Press DIMMER to set the brightness to [BRIGHT] or [DARK] if set to [OFF] (page 33).

Sensors of the TV do not work properly.

- The bar speaker may block some sensors (such as the brightness sensor), the remote control receiver of your TV or the emitter for 3D glasses (infrared transmission) of a 3D TV that supports the infrared 3D glass system, or wireless communication. Move the bar speaker away from the TV within a range that allows those parts to operate properly. For the locations of the sensors and remote control receiver, refer to the operating instructions of the TV.

Wireless function (the BLUETOOTH function or wireless amplifier) is unstable.

- Do not place metal objects other than a TV around the speaker system.

The speaker system does not work properly ([.DEMO] appears in the front panel display).

- The speaker system is in demo mode. To cancel demo mode, reset the speaker system. Press and hold  (power) and – (volume) on the subwoofer for more than 5 seconds (page 40).

When you change to the TV input from the USB input by pressing INPUT, the message appears.

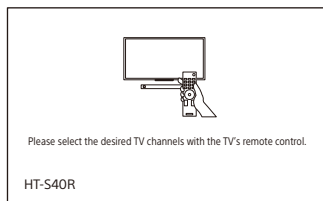

- * This screen is an example for English.
- Select the TV program by using the TV remote control.

Resetting the Speaker System

If the speaker system still does not operate properly, reset the speaker system as follows.

- 1 Press MENU.**
[CURRENT STATUS] appears in the front panel display.
- 2 Press $\blacktriangle/\blacktriangledown$ to select [RESET], then press ENTER.**
- 3 Press $\blacktriangle/\blacktriangledown$ to select [ALL RESET], then press ENTER.**
- 4 Press $\blacktriangle/\blacktriangledown$ to select [START], then press ENTER.**
All the settings return to their initial status.

To cancel resetting

Select [CANCEL] in step 4.

If You Cannot Perform Resetting Using the Setting Menu

Press and hold $\text{\textcircled{P}}$ (power) and - (volume) on the subwoofer for more than 5 seconds.

The settings return to their initial status.

Note

By resetting, the link with the wireless amplifier may be lost. In this case, perform "Connecting the Wireless Amplifier Manually" (page 14).

Additional Information

Specifications

Subwoofer (SA-WS40R)

Amplifier section

POWER OUTPUT (rated)

Front L + Front R: 50 W + 50 W
(at 8 ohms, 1 kHz, 1% THD)

POWER OUTPUT (reference)

Front L/Front R/Center: 90 W (per channel at 8 ohms, 1 kHz)
Subwoofer: 180 W (at 4 ohms, 100 Hz)

Inputs

TV IN (OPTICAL)
USB
ANALOG IN

Output

HDMI OUT (TV (ARC))

HDMI Section

Connector

Type A (19pin)

USB section

⚡ (USB) port:

Type A

BLUETOOTH section

Communication system

BLUETOOTH Specification version 5.0

Output

BLUETOOTH Specification Power
Class 1

Maximum communication range

Line of sight approx. 10 m¹⁾

Frequency band

2.4 GHz band (2.4000 GHz -
2.4835 GHz)

Modulation method

FHSS (Freq Hopping Spread Spectrum)

Compatible BLUETOOTH profiles²⁾

A2DP (Advanced Audio Distribution
Profile)
AVRCP (Audio Video Remote Control
Profile)

Supported Codec³⁾

SBC⁴⁾

Transmission range (A2DP)

20 Hz - 20,000 Hz (Sampling frequency
32 kHz, 44.1 kHz, 48 kHz)

- 1) The actual range will vary depending on factors such as obstacles between devices, magnetic fields around a microwave oven, static electricity, cordless phone use, reception sensitivity, the operating system, software applications, etc.
- 2) BLUETOOTH standard profiles indicate the purpose of BLUETOOTH communication between devices.
- 3) Codec: Audio signal compression and conversion format
- 4) Abbreviation for Subband Codec

Speaker section

Speaker system

Subwoofer system, Bass reflex

Speaker

160 mm cone type

General

Power requirements

220 V - 240 V AC, 50 Hz/60 Hz

Power consumption

On: 55 W

Standby mode: 0.5 W or less (Power Saving mode)

(When [CONTROL FOR HDMI] in [HDMI] and [STANDBY] in [BT] are set to [OFF])

Standby mode: 2 W or less*

(When [CONTROL FOR HDMI] in [HDMI] and [STANDBY] in [BT] are set to [ON])

* The speaker system will automatically enter Power saving mode when there is no HDMI connection and no BLUETOOTH pairing history.

Dimensions* (approx.) (w/h/d)

192 mm × 387 mm × 366 mm

* Not including projection portion

Mass (approx.)

7.8 kg

Bar Speaker (SS-S40R)

Speaker system

Full range speaker system, Bass reflex

Speaker

42 mm × 100 mm cone type

Dimensions* (approx.) (w/h/d)

900 mm × 52 mm × 74.5 mm

* Not including projection portion

Mass (approx.)

2 kg

Wireless Amplifier (TA-S40RWR)

POWER OUTPUT (reference)

Surround L/Surround R: 75 W (per channel at 4 ohms, 1 kHz)

Power requirements

220 V - 240 V AC, 50 Hz/60 Hz

Power consumption

On: 20 W

Standby mode: 0.5 W or less

Dimensions* (approx.) (w/h/d)

160 mm × 52 mm × 160 mm

* Not including projection portion

Mass (approx.)

0.8 kg

Surround Speakers (SS-SS40R)

Speaker system

Full range speaker system, Bass reflex

Speaker

65 mm cone type

Dimensions* (approx.) (w/h/d)

83 mm × 180 mm × 74.5 mm

* Not including projection portion

Mass (approx.)

0.6 kg

Wireless Transmitter/ Receiver Section

Frequency band

2.4 GHz (2.404 GHz - 2.476 GHz)

Modulation method

GFSK

Supplied Accessories

- Remote control (1)
- R03 (size AAA) battery (2)
- WALL MOUNT TEMPLATE (1)
- HDMI cable (1)
- AC power cord (mains lead) (2)
- Startup Guide
- Operating Instructions (this document)

Design and specifications are subject to change without notice.

Playable Types of Files

Codec	Extension
MP3 (MPEG-1 Audio Layer III)	.mp3
WMA9 Standard	.wma
LPCM (2ch)	.wav

Notes

- Some files may not play or may play with no sound depending on the file format, the file encoding, or the recording condition.
- Some files edited on a PC may not play.
- The speaker system does not play coded files such as DRM and Lossless.
- The speaker system can recognize the following files or folders in USB devices:
 - up to 200 folders (including empty folders and root folders)
 - up to 200 tracks in one folder
 - up to folders in the 8th layer (including the root folder)
- Some USB devices may not work with this speaker system.
- The speaker system can recognize Mass Storage Class (MSC) devices.
- The sampling frequency is up to 48 kHz.

Supported Input Audio Formats

Audio formats supported by this speaker system are as follows.

- Dolby Digital
- Linear PCM 2ch (up to 48kHz)

On BLUETOOTH Communication

- BLUETOOTH devices should be used within approximately 10 meters (33 feet) (unobstructed distance) of each other. The effective communication range may become shorter under the following conditions.
 - When a person, metal object, wall or other obstruction is between the devices with a BLUETOOTH connection
 - Locations where a wireless LAN is installed
 - Around microwave ovens that are in use
 - Locations where other electromagnetic waves occur
- BLUETOOTH devices and wireless LAN (IEEE 802.11b/g/n) use the same frequency band (2.4 GHz). When using your BLUETOOTH device near a device with wireless LAN capability, electromagnetic interference may occur. This could result in lower data transfer rates, noise, or inability to connect. If this happens, try the following remedies:
 - Use this speaker system at least 10 meters (33 feet) away from the wireless LAN device.
 - Turn off the power to the wireless LAN device when using your BLUETOOTH device within 10 meters (33 feet).
 - Install this speaker system and BLUETOOTH device as close to each other as possible.
- The radio waves broadcast by this speaker system may interfere with the operation of some medical devices. Since this interference may result in malfunction, always turn off the power on this speaker system and BLUETOOTH device in the following locations:
 - In hospitals, on trains, in airplanes, at gas stations, and any place where flammable gasses may be present
 - Near automatic doors or fire alarms
- This speaker system supports security functions that comply with the BLUETOOTH specification to ensure secure connection during communication using BLUETOOTH technology. However,

this security may be insufficient depending on the setting contents and other factors, so always be careful when performing communication using BLUETOOTH technology.

- Sony cannot be held liable in any way for damages or other loss resulting from information leaks during communication using BLUETOOTH technology.
- BLUETOOTH communication is not necessarily guaranteed with all BLUETOOTH devices that have the same profile as this speaker system.
- BLUETOOTH devices connected with this speaker system must comply with the BLUETOOTH specification prescribed by the Bluetooth SIG, Inc., and must be certified to comply. However, even when a device complies with the BLUETOOTH specification, there may be cases where the characteristics or specifications of the BLUETOOTH device make it impossible to connect, or may result in different control methods, display or operation.
- Noise may occur or the audio may cut off depending on the BLUETOOTH device connected with this speaker system, the communications environment, or surrounding conditions.

If you have any questions or problems concerning your speaker system, please consult your nearest Sony dealer.

Precautions

On safety

- Should any solid object or liquid fall into the speaker system, unplug the speaker system and have it checked by qualified personnel before operating it any further.
- Do not touch the AC power cord (mains lead) with wet hands. Doing so may cause an electric shock.
- Do not climb on the bar speaker, subwoofer and surround speakers as you may fall down and injure yourself, or speaker system damage may result.

On power sources

- Before operating the speaker system, check that the operating voltage is identical to your local power supply. The operating voltage is indicated on the nameplate at the rear of the subwoofer.
- If you are not going to use the speaker system for a long time, be sure to disconnect the speaker system from the wall outlet (mains). To disconnect the AC power cord (mains lead), grasp the plug itself; never pull the cord.
- AC power cord (mains lead) must be changed only at a qualified service shop.

On heat buildup

Although the speaker system heats up during operation, this is not a malfunction. If you continuously use this speaker system at high volume, the speaker system temperature rises considerably. To avoid burning yourself, do not touch the speaker system.

On placement

- Place the speaker system in a location with adequate ventilation to prevent heat buildup and prolong the life of the speaker system.
- Do not place the speaker system near heat sources or in a place subject to direct sunlight, excessive dust, or mechanical shock.
- Do not place the bar speaker, subwoofer and surround speakers on a soft surface

(rugs, blankets, etc.) or place anything at the rear of the bar speaker, subwoofer and surround speakers that might block the ventilation holes and cause malfunctions.

- If the speaker system is being used in combination with a TV, VCR, or tape deck, noise may result and picture quality may be affected. In this case, place the speaker system away from the TV, VCR, or tape deck.
- Use caution when placing the speaker system on a surface that has been specially treated (with wax, oil, polish, etc.), as staining or discoloration of the surface may result.
- Take care to avoid any possible injury from the corners of the bar speaker, subwoofer and surround speakers.
- Keep 3 cm (1 3/16 in) or more space under the bar speaker and surround speakers when you hang it on a wall.

On operation

Before connecting other device, be sure to turn off and unplug the speaker system.

If you encounter color irregularity on a nearby TV screen

Color irregularities may be observed on certain types of TV.

- If color irregularity is observed...
Turn off the TV, then turn it on again after 15 to 30 minutes.
- If color irregularity is observed again...
Place the speaker system further away from the TV.

On cleaning

Clean the speaker system with a soft, dry cloth. Do not use any type of abrasive pad, scouring powder, or solvent such as alcohol or benzine.

On handling the subwoofer

Do not place your hand into the slit of the subwoofer when lifting it. The speaker driver may be damaged. When lifting it, hold the bottom of the subwoofer.

If you have any question or problem concerning your speaker system, please consult your nearest Sony dealer.

Copyrights and Trademarks

This speaker system incorporates Dolby* Digital.

* Manufactured under license from Dolby Laboratories. Dolby, Dolby Audio, and the double-D symbol are trademarks of Dolby Laboratories Licensing Corporation.

The terms HDMI, HDMI High-Definition Multimedia Interface, and the HDMI Logo are trademarks or registered trademarks of HDMI Licensing Administrator, Inc.

The BLUETOOTH® word mark and logos are registered trademarks owned by Bluetooth SIG, Inc. and any use of such marks by Sony Corporation is under license. Other trademarks and trade names are those of their respective owners.

"BRAVIA" logo is a trademark of Sony Corporation.

"PlayStation" is a registered trademark or trademark of Sony Interactive Entertainment Inc.

MPEG Layer-3 audio coding technology and patents licensed from Fraunhofer IIS and Thomson.

Windows Media is either a registered trademark or trademark of Microsoft Corporation in the United States and/or other countries.

This product is protected by certain intellectual property rights of Microsoft Corporation. Use or distribution of such technology outside of this product is prohibited without a license from Microsoft or an authorized Microsoft subsidiary.

All other trademarks are trademarks of their respective owners.

Index

Buttons

DIMMER 33
NIGHT 25
VOICE 25

A

ARC 7
Audio DRC 31
Audio format 43
Audio Return Channel 7
Audio settings 31
Auto Standby 32

B

BLUETOOTH
 Pairing 20
 Settings 31
 Standby 31
Brightness
 Front panel display 33
 Indicator 33

C

Connection (See "Wired connection"
 or "Wireless connection" in "Index")
Control for HDMI 27
Current settings 26

H

HDMI settings 31

I

Installation 11

M

Multiplex broadcast sound 31

N

Night mode 25

O

One-touch play 28

P

PROTECT 39

R

Remote control 9
Resetting 40

S

Settings
 Audio 31
 BLUETOOTH 31
 Brightness 33
 Current status 30
 HDMI 31
 Menu 29
 Resetting 40
 Speaker 30
 System 32
 USB 31
Software
 Update 32
 Version 32
Sound Mode 24
Speaker settings 30
System settings 32

U

USB settings 31

V

Version
 Speaker system 32
 Wireless amplifier 32
Voice mode 25

W

Wall mount 11
Wired connection 11
Wireless connection
 BLUETOOTH devices 20
 TV 15
 Wireless amplifier 14

When there is a software update available, we will notify you on the following website:
<https://www.sony-asia.com/support>

 **Dolby** Audio

HDMITM

HIGH-DEFINITION MULTIMEDIA INTERFACE



* 5 0 2 2 2 7 5 2 1 * (2)