



Washing Machine

User manual

WA75A40****/WA70A40****/WA65A40****

SAMSUNG

Contents

Safety information	3
What you need to know about the safety instructions	3
Important safety symbols	3
Important safety precautions	4
Instructions about the WEEE	10
Installation	11
What's included	11
Installation requirements	13
Step-by-step installation	14
Before you start	21
The basics	21
Laundry guidelines	23
Operations	28
Control panel	28
Simple steps to start	29
Auto cycles	30
Manual cycles	31
Maintenance	32
Cleaning	32
Troubleshooting	36
Checkpoints	36
Specifications	42
Specification sheet	42

Safety information

Congratulations on your new Samsung washing machine. This manual contains important information on the installation, use and care of your appliance. Please take some time to read this manual to take full advantage of your washing machine's many benefits and features.

What you need to know about the safety instructions

Please read this manual thoroughly to ensure that you know how to safely and efficiently operate the extensive features and functions of your new appliance. Please store the manual in a safe location close to the appliance for future reference. Use this appliance only for its intended purpose as described in this instruction manual.

Warnings and Important Safety Instructions in this manual do not cover all possible conditions and situations that may occur. It is your responsibility to use common sense, caution and care when installing, maintaining and operating your washing machine. Because the following operating instructions cover various models, the characteristics of your washing machine may differ slightly from those described in this manual and not all warning signs may be applicable. If you have any questions or concerns, contact your nearest service centre or find help and information online at www.samsung.com.

Important safety symbols

What the icons and signs in this user manual mean:

 **WARNING**

Hazards or unsafe practices that may result in **severe personal injury, death and/or property damage**.

 **CAUTION**

Hazards or unsafe practices that may result in **personal injury and/or property damage**.

 **NOTE**

Indicates that a risk of personal injury or material damage exists.

These warning signs are here to prevent injury to yourself and others.

Please follow them explicitly.

After reading this manual, store it in a safe place for future reference.

Read all instructions before using the appliance.

As with any equipment that uses electricity and moving parts, potential hazards exist. To safely operate this appliance, familiarize yourself with its operation and exercise care when using it.

Safety information

Important safety precautions

WARNING

To reduce the risk of fire, electric shock, or injury to persons when using your appliance, follow basic precautions, including the following:

- 1.** This appliance is not intended for use by persons (including children) with reduced physical, sensory or mental capabilities, or lack of experience and knowledge, unless they have been given supervision or instruction concerning use of the appliance by a person responsible for their safety.
- 2. For use in Europe:** This appliance can be used by children aged from 8 years and above and persons with reduced physical, sensory or mental capabilities or lack of experience and knowledge if they have been given supervision or instruction concerning use of the appliance in a safe way and understand the hazards involved. Children shall not play with the appliance. Cleaning and user maintenance shall not be made by children without supervision.
- 3.** Children should be supervised to ensure that they do not play with the appliance.
- 4.** If the supply cord is damaged, it must be replaced by the manufacturer, its service agent or similarly qualified persons in order to avoid a hazard.

-
5. The new hose-sets supplied with the appliance are to be used and that old hose-sets should not be reused.
 6. For washing machines having ventilation openings in the base, the installation instructions shall state that the openings must not be obstructed by a carpet.
 7. **For use in Europe:** Children of less than 3 years should be kept away unless continuously supervised.
 8. **CAUTION:** In order to avoid a hazard due to inadvertent resetting of the thermal cut-out, this appliance must not be supplied through an external switching device, such as a timer, or connected to a circuit that is regularly switched on and off by the utility.
 9. This appliance is intended to be used in household only and it is not intended to be used such as:
 - staff kitchen areas in shops, offices and other working environments;
 - farm houses;
 - by clients in hotels, motels and other residential type environments;
 - bed and breakfast type environments;
 - areas for communal use in blocks of flats or in launderettes.

Safety information

Critical installation warnings

WARNING

The installation of this appliance must be performed by a qualified technician or service company.

- Failure to do so may result in electric shock, fire, an explosion, problems with the product, or injury.

Plug the power cord into a wall socket that meets local electrical specifications. Use the socket for this appliance only, and do not use an extension cord.

- Sharing a wall socket with other appliances using a power strip or extending the power cord may result in electric shock or fire.
- Ensure that the power voltage, frequency, and current are the same as those of the product specifications. Failure to do so may result in electric shock or fire. Plug the power plug into the wall socket firmly.

Remove all foreign substances such as dust or water from the power plug terminals and contact points using a dry cloth on a regular basis.

- Unplug the power plug and clean it with a dry cloth.
- Failure to do so may result in electric shock or fire.
- Plug the power plug into the wall socket so that the cord is running towards the floor. If you plug the power plug into the socket in the opposite direction, the electric wires within the cable may be damaged and this may result in electric shock or fire.

This appliance must be properly grounded.

Do not ground the appliance to a gas pipe, plastic water pipe, or telephone line.

- This may result in electric shock, fire, an explosion, or problems with the product.
- Never plug the power cord into a socket that is not grounded correctly and make sure that it is in accordance with local and national regulations.

Do not install this appliance near a heater or any inflammable material.

Do not install this appliance in a humid, oily or dusty location, or in a location exposed to direct sunlight or water (rain drops).

Do not install this appliance in a location exposed to low temperatures.

- Frost may cause the tubes to burst.

Do not use an electric transformer.

- This may result in electric shock or fire.

Do not use a damaged power plug, damaged power cord, or loose wall socket.

- This may result in electric shock or fire.

Do not pull or excessively bend the power cord.

Do not twist or tie the power cord.

Do not hook the power cord over a metal object, place a heavy object on the power cord, insert the power cord between objects, or push the power cord into the space behind the appliance.

- This may result in electric shock or fire.

This appliance should be positioned so that the power plug, the water supply taps, and the drain pipes are accessible.

Installation cautions

CAUTION

This appliance should be positioned in such a way that the power plug is easily accessible.

- Failure to do so may result in electric shock or fire due to electric leakage.

Critical usage warnings

WARNING

If the appliance is flooded, turn off the water & power supplies immediately and contact your nearest service centre.

- Do not touch the power plug with wet hands.
- Failure to do so may result in electric shock.

If the appliance generates a strange noise, a burning smell, or smoke, unplug the power plug immediately and contact your nearest Samsung Customer Service.

- Failure to do so may result in electric shock or fire.

In the event of a gas leak (such as propane gas, LP gas, etc.), ventilate immediately without touching the power plug. Do not touch the appliance or power cord.

- Do not use a ventilating fan.
- A spark may result in an explosion or fire.

Do not let children play in or on the washing machine. In addition, when disposing of the appliance, remove the lid.

- If trapped inside the product, children may suffocate to death.

Safety information

Do not wash items contaminated with gasoline, kerosene, benzene, paint thinner, alcohol or other inflammable or explosive substances.

- This may result in electric shock, fire, or an explosion.

Do not touch the power plug with wet hands.

- This may result in electric shock.

Do not insert your hand or a metal object under the washing machine while an operation is in progress.

- This may result in injury.

Do not attempt to repair, disassemble, or modify the appliance yourself.

- Do not use a fuse (such as copper, steel wire, etc.) other than a standard fuse.
- When the appliance needs to be repaired or reinstalled, contact your nearest service centre.
- Failure to do so may result in electric shock, fire, problems with the product, or injury.
- In this case, the product will not be covered by the standard warranty provided by Samsung and no responsibility can be attributed to Samsung for malfunctions or damages resulting from doing it.

Unplug the power plug when the appliance is not being used for long periods of time or during a thunder or lightning storm.

- Failure to do so may result in electric shock or fire.

Do not put your hand into the spinning tub during the spin cycle.

- This may result in injury. If the tub does not stop spinning within 15 seconds after you open the lid, contact your nearest Samsung Customer Service.

Do not let children (or pets) play in or on your washing machine.

The washing machine door does not open easily from the inside and children may be seriously injured if trapped inside.

Do not use the water to exceed 50 °C when using the hot water in your washing machine.

Plastic parts may be deformed or damaged, and this may result in electric shock or fire.

Usage cautions

CAUTION

When the washing machine is contaminated by a foreign substance such as detergent, dirt, food waste, etc., unplug the power plug and clean the washing machine using a damp, soft cloth.

- Failure to do so may result in discolouration, deformation, damage, or rust.

The product you have purchased is designed for domestic use only.

Using the product for business purposes qualifies as a product misuse. In this case, the product will not be covered by the standard warranty provided by Samsung and no responsibility can be attributed to Samsung for malfunctions or damages resulting from such misuse.

Do not stand on the appliance or place objects (such as laundry, lighted candles, lighted cigarettes, dishes, chemicals, metal objects, etc.) on the appliance.

- This may result in electric shock, fire, problems with the product, or injury.

Do not press the buttons using sharp objects such as pins, knives, fingernails, etc.

- This may result in electric shock or injury.

Critical cleaning warnings

WARNING

Do not clean the appliance by spraying water directly onto it.

Do not use the strong acidic cleaning agent.

Before cleaning or performing maintenance, unplug the appliance from the wall socket.

- Failure to do so may result in electric shock or fire.

Safety information

Instructions about the WEEE



Correct Disposal of This Product (Waste Electrical & Electronic Equipment)

(Applicable in countries with separate collection systems)

This marking on the product, accessories or literature indicates that the product and its electronic accessories (e.g. charger, headset, USB cable) should not be disposed of with other household waste at the end of their working life. To prevent possible harm to the environment or human health from uncontrolled waste disposal, please separate these items from other types of waste and recycle them responsibly to promote the sustainable reuse of material resources.

Household users should contact either the retailer where they purchased this product, or their local government office, for details of where and how they can take these items for environmentally safe recycling.

Business users should contact their supplier and check the terms and conditions of the purchase contract. This product and its electronic accessories should not be mixed with other commercial wastes for disposal.

For more information on safe disposal and recycling, visit our website www.samsung.com or contact our Helpline numbers on the last page.

Installation

Follow these instructions carefully to ensure proper installation of the washing machine and to prevent accidents when doing laundry.

What's included

Make sure all the parts are included in the product package. If you have a problem with the washing machine or the parts, contact a local Samsung customer centre or the retailer.

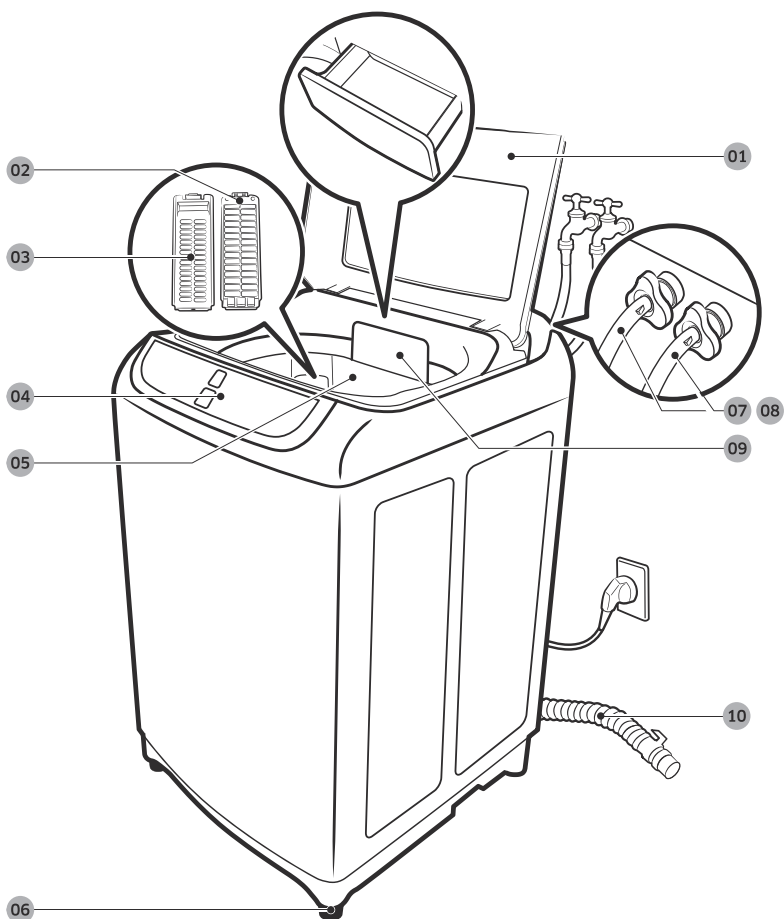

Installation

01 Door

04 Control panel

07 Water hose (Cold)

10 Drain hose

02 Magic Filter (Rear)

05 Tub

08 Water hose (Hot) *

03 Magic Filter (Front)

06 Levelling feet

09 Detergent drawer

NOTE

- Availability of parts with an asterisk (*) depends on the model.
- Door: Make sure to keep the door closed while the washing machine is operating.
- Magic Filter: This collects lint that builds up from the laundry being washed.
- Grounding lead: Cover this lead if wired to a metal part for earth-grounding.
- Levelling feet: Adjust the feet to level the washing machine on a flat floor.

Installation requirements

Electrical supply and grounding

WARNING

- AC 220 V / 50 Hz fuse or circuit breaker is required.
- Use an individual branch circuit specific to the washing machine.
- Do NOT use an extension cord.
- Use only the power cord that comes with the washing machine.
- Do NOT connect the ground wire to plastic plumbing, gas lines, or hot water pipes.

Levelling

- To prevent tumbling or noise, install the washing machine on a solid, flat floor without a platform or bricks.
- Keep the washing machine at 10 cm from each adjacent wall.

Water supply

- Make sure water taps are easily accessible.
- Turn off the taps when the washing machine is not in use.
- Check for any leaks at the water hose fittings on a regular basis.

Drain

- Make sure the drain hose is not clogged.
- We recommend a standpipe in height of 90-100 cm. The drain hose must be connected through the hose clip to the standpipe, and the standpipe must fully cover the drain hose.

The standpipe specifications mentioned here are only applicable to pump-type models.

Installation

Step-by-step installation

STEP 1 Select a location

Location requirements:

- Solid, level surface without carpeting or flooring that may obstruct ventilation
- Away from direct sunlight
- Adequate room for ventilation and wiring
- The ambient temperature is always higher than the freezing point (0 °C)
- Away from a heat source

Anti-rat panel

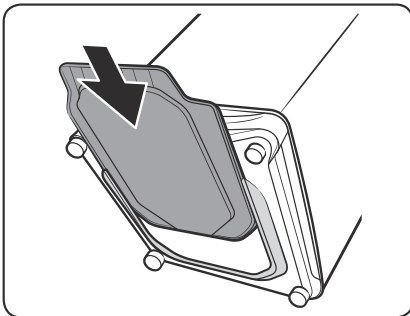

The washing machine comes with the Anti-rat panel that protects small animals such as rats from entering the machine. Insert the panel into the bottom of the machine. To facilitate the work, slightly lift up the bottom front.

NOTE

- Some models feature the Anti-rat panel that must be inserted from the rear bottom of the model. For this model, insert the Anti-rat panel before levelling the machine. To facilitate the work, slightly lift up the bottom rear.
- Availability of the Anti-rat panel depends on the model.

STEP 2 Adjust the levelling feet

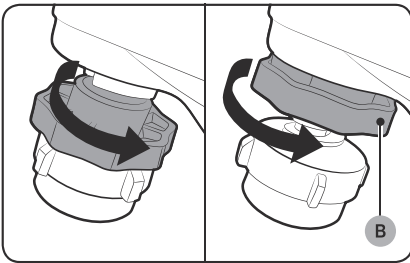
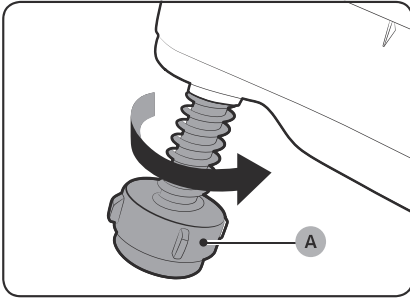

Unpack the product package.

1. Gently slide the washing machine into position. Excessive force may damage the levelling feet (A).
2. Level the washing machine by manually adjusting the levelling feet.
3. When levelling is complete, tighten the nuts (B) if provided (some models may not have the nuts).

WARNING

Packaging materials can be dangerous to children. Dispose all packaging material (plastic bags, polystyrene, etc.) out of children's reach.

STEP 3 Connect the water hose

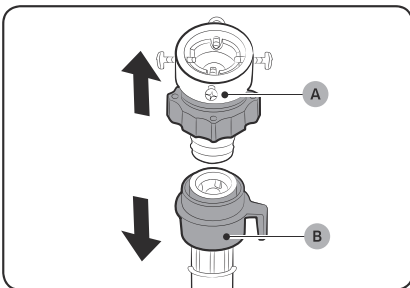

Connect the water hose to the water tap.

1. Remove the adaptor (A) from the water hose (B).

Installation

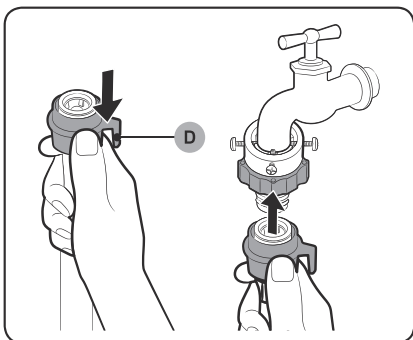
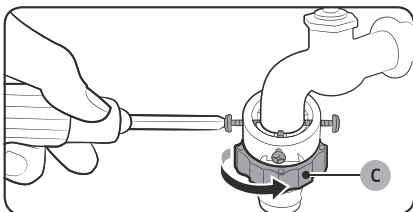
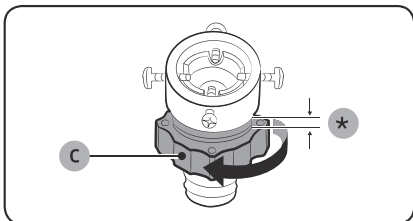
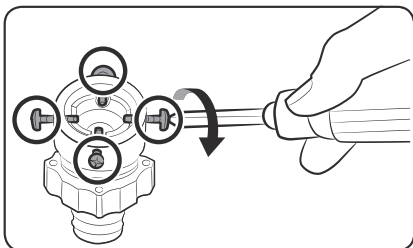

2. Use a Philips screwdriver to loosen four screws on the adaptor.

3. Hold the adaptor and turn **part (C)** in the arrow direction to loosen it by 5 mm (*).

4. Insert the adaptor into the water tap, and tighten the screws while lifting up the adaptor.

5. Turn **part (C)** in the arrow direction to tighten it.

6. While holding down **part (D)**, connect the water hose to the adaptor. Then, release **part (D)**. The hose fits into the adaptor with a clicking sound.

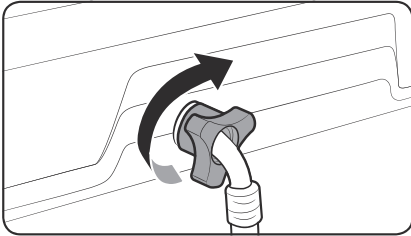

7. Connect the other end of the water hose to the inlet valve on the back of the washing machine. Turn the hose clockwise to tighten.

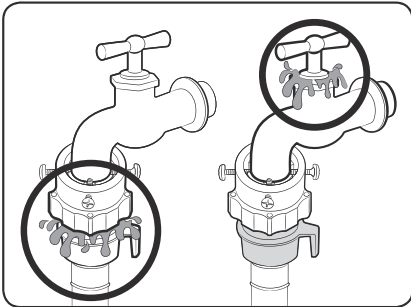

8. Open the water tap and check if there are any leaks around the connection areas.
- If there are water leaks, repeat the steps above.

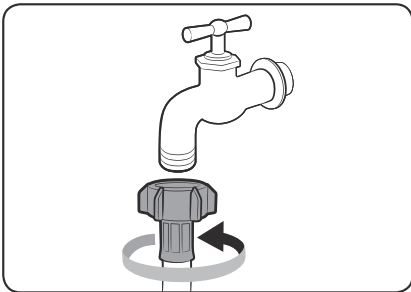

- If using a screw type of water tap, connect the water hose to the water tap as shown.

Please use the horizontal tap

Horizontal tap



Extension tap



Square tap



⚠ WARNING

Stop using the washing machine if there is a water leak, and contact a local Samsung service centre. Otherwise, this may cause electric shock.

⚠ CAUTION

Do not stretch the water hose by force. If the hose is too short, replace the hose with a longer, high-pressure hose.

Installation

NOTE

- After connecting the water hose to the adaptor, check if it is connected properly by pulling the water hose downwards.
- Use a standard type of water tap. If the tap is square-shaped or too big, remove the spacer ring before inserting the tap into the adaptor.

STEP 4 Position the drain hose

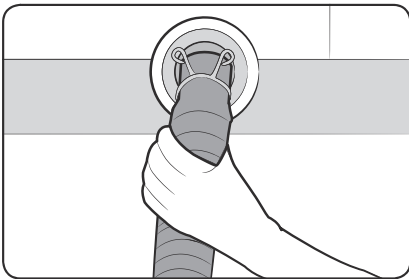
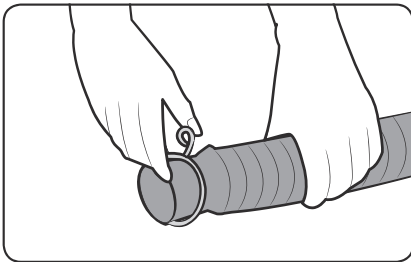

General type

1. Press and hold down the joint ring, and insert it into the drain hose.
2. Insert the drain hose into the drain outlet. Make sure to connect them firmly using the joint ring. The drain hose is extensible. Adjust the length of the drain hose as needed.

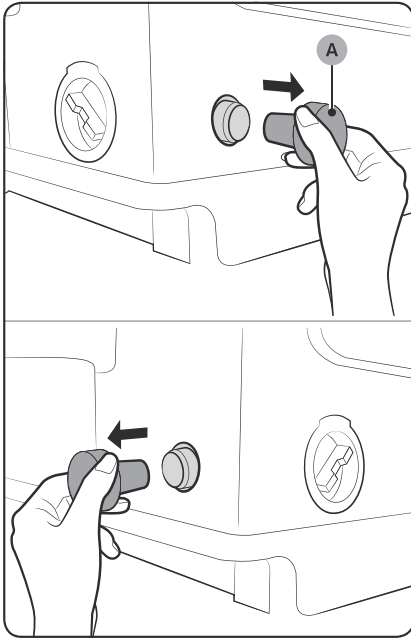

Pump type

1. Open the hose cap (A), and insert the drain hose. Tighten the drain hose using the joint ring.

NOTE

- The position (side or rear) of the drain outlet depends on the model.
- Availability of the hose cap depends on the model.

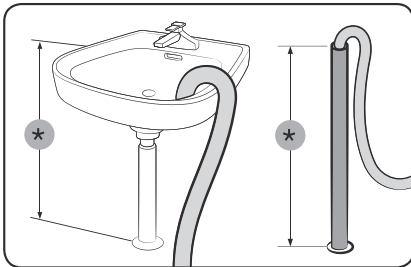

2. Connect the other end of the drain hose to a standpipe or basin that is positioned 90-100 cm (*) from the floor.

WARNING

Make sure the end of the drain hose is not submerged by water. Otherwise, the washing machine may suffer serious damage.

Installation

⚠ CAUTION

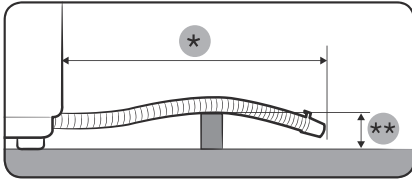

- Do not exceed 3 m (*) for the total length of extended hoses.
- Do not let the drain hose run over doorsills that protrude 5 cm (**) or more from the floor.
- Do not run the drain hose under the bottom of the machine.

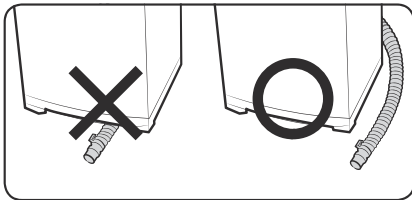

STEP 5 Power on

Plug the power cord into a wall socket featuring an AC 220 V / 50 Hz approved electrical outlet protected by a fuse or circuit breaker. Then, press **POWER** to turn on the washing machine.

Before you start

The basics

Detergent drawer

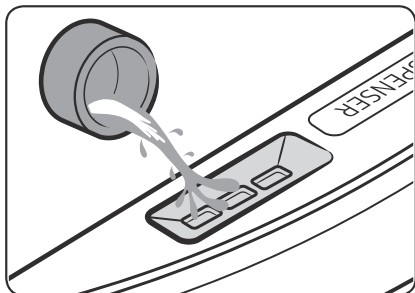
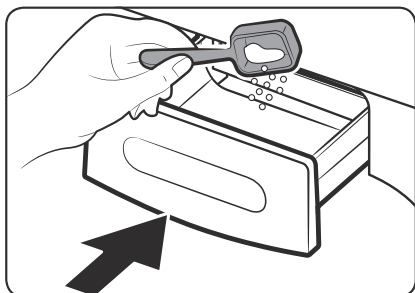

To add a laundry-specific detergent, follow these steps:

1. Open the door.
2. Locate the detergent drawer, and slide it open.
3. Apply powder detergent as recommended by the manufacturer.
4. Add fabric softener as recommended by the manufacturer, and then close the cover.

CAUTION

Make sure to use detergent as appropriate. An excessive amount of detergent may not dissolve well.

- Do not add too much softener. This may reduce the performance.
- Do not leave softener into the softener dispenser for a long time. The softener becomes hardened and may not dissolve well.

Child Lock

Child Lock is designed to prevent accidents by children or infants, such as drowning.

1. Press **Power**.
2. To activate the Child Lock, hold down **Function** and **Monsoon** simultaneously for 3 seconds. The indicator blinks.
3. To deactivate the Child Lock, hold down **Function** and **Monsoon** simultaneously for 3 seconds. The indicator turns off. If the tub has contained water, simply restart the machine and hold down two buttons simultaneously for 3 seconds to deactivate the Child Lock.

Before you start

With the Child Lock enabled

- You can still manipulate on the control panel while the door is closed. If you open the door, an information code (CL, dC) appears with an alarm. Then, the machine starts forced draining after 30 seconds in order to prevent infant or child accidents such as drowning.
- If the door leaves open for 30 seconds with the tub containing water, the machine drains the water with the “CL” code, which you cannot stop.
- To add detergent or more laundry in the tub, or to change the cycle settings, you must first deactivate the Child Lock.

 **WARNING**

If you open the door with the Child Lock enabled, the machine starts forced draining to prevent accidents such as drowning.

 **NOTE**

The Child Lock remains active after you power off the machine. You cannot deactivate the Child Lock as long as the “CL” code appears on the display. But, you can deactivate when the dC code appears by holding down two buttons simultaneously.

Laundry guidelines

Checkpoints

- Check for stains or dirt. Apply a little detergent to a white towel. Rub the white towel and the dirty clothes together to transfer the dirt or colour to the white towel.
- Before washing, pre-treat the sleeves, collars, dress hems, and pockets by brushing with detergent.
- Wrinkle-processed clothes made of wool must be specially treated by tightening them with threads before washing. Remove the threads after washing and drying is complete.



CAUTION

- Do not place or keep blankets in the tub.
- Do not put candles or a heat source in or on the washing machine.
- Do not wash these clothes:
 - Neckties, brassieres, jackets, suits, and coats can be easily deformed by shrinking or discolouring on the surface. These clothes are mostly made of rayon, polynosic, cuff, and/or blended fabric.
 - Wrinkle-processed, embossed, or resin processed clothes easily deform merely by soaking in water.
 - Clothes that are easily discoloured made from cotton, wool, wrinkled silk, leather wear and accessories, and leather ornamented clothes and accessories.
 - Waterproof sheets, mattresses, or wool quilts, rain covers, fishing jackets and trousers, skiwear, sleeping bags, diaper covers, sweat suits, vehicle covers for automobiles, bicycles, and motorcycles, bath rugs, and other waterproof items.

Before you start

STEP 1 Sort

Sort the laundry according to these criteria:

- Care Label: Sort the laundry into cottons, mixed fibres, synthetics, silks, wools, and rayon.
- Colour: Separate whites from colours.
- Size: Mixing different-sized items together in the tub improves the washing performance.
- Sensitivity: Follow the cloth-specific instructions on the care label of delicate items such as pure, new woollen items, curtains, and silk items.

NOTE

Make sure to check the care label on the clothing, and sort them accordingly before starting the wash.

STEP 2 Empty pockets

Empty all the pockets of your laundry items, and remove dirt and/or soils from them.

- Metal objects such as coins, pins, and buckles on clothing may damage other laundry items as well as the tub.
- Turn clothing with buttons and embroideries inside out.
- If pants or jacket zippers are open while washing, the tub may be damaged.
- Zippers should be closed and fixed with a string.
- Clothing with long strings may become entangled with other clothes. Make sure to tie the strings before washing.

STEP 3 Use a laundry net or wash certain items separately

- Brassieres (water washable) must be placed in a laundry net. Metal parts of the brassieres may break through and tear other laundry items.
- Cashmilon, large volume garments, and lightweight clothes (lace-decorated clothes, lingerie, nylon stocking, and synthetic fabrics) may float on water during washing and cause problems to the machine. Use the laundry net or wash them separately.
- Do not wash the laundry net by itself without other laundry. This may cause abnormal vibrations that could move the washing machine and result in injury.

⚠ CAUTION

Make sure to soak inflatable items (such as blankets, and cotton-filled or microfibre quillets) in water before you run a cycle.

- Inflatable items may cause damage to the laundry or the machine during the wash or drying process.
- Regardless of the size, blankets or quilts are safer and cleaner to wash one item at a time. Two different-sized blankets in the same load may compromise the drying performance due to unbalanced loads.

To input a blanket

Fold the blanket as shown, and then put it on the **plastic area (A)** of the tub before inserting into the tub.

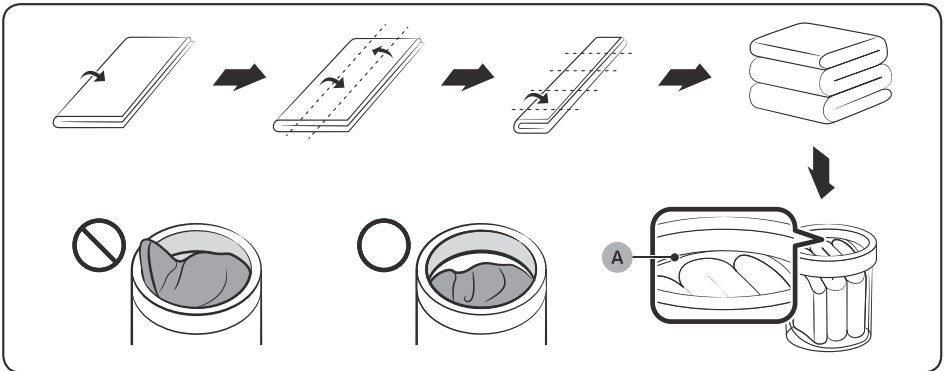

Before you start

STEP 4 Prewash (if necessary)

- To remove stains and dirt on collars, sleeves, hems, and pockets, apply detergent lightly and brush off.
- Use powder or liquid detergents. Do not use soap, as this may remain on the tub after washing.
- Prewash white socks, sleeves, and collars with a little detergent and a brush.

CAUTION

Make sure the laundry is inserted completely.

- Any exposed part of the laundry may cause damage to the machine or the laundry itself, or a water leak.
- Make sure the laundry does not exceed the **plastic area (A)** in the above figure.

STEP 5 Determine the load capacity

Make sure the laundry does not exceed the **plastic area (A)** in the figure on page 25.

Otherwise, it may cause the washing machine to not wash properly or cause damage to the machine or the laundry itself, or a water leak.

NOTE

When washing bedding or bedding covers, the wash time may be lengthened or the spin efficiency may be reduced. For bedding or bedding covers, the recommended load capacity is 3.5 kg or less.

CAUTION

If the laundry is unbalanced and the “**Ub**” information code is displayed, redistribute the load. Unbalanced laundry may reduce the spinning performance and cause damage to the machine or the laundry itself.

STEP 6 Apply a proper detergent type

The type of detergent depends on the type of fabric (cotton, synthetic, delicate items, wool), colour, wash temperature, and degree of soiling. Always use “low suds” laundry detergent, which is designed for automatic washing machines.

CAUTION

- Use an appropriate amount of detergent. Excess amounts of detergent do not produce much improvement in washing results but cause damage to the laundry due to deteriorated rinsing performance.
- Bleach is strong alkali in nature, causing damage to or discolouration of the laundry.
- Use a longer or added rinse cycle when using powder detergent that is very likely to remain on the laundry and cause bad odours after washing is complete.
- If an excessive amount of detergent is used especially in cold water, the detergent doesn't dissolve well, ending up with contaminated laundry, hoses, and/or tub.
- In case of timed washing, do not apply detergent directly to laundry or the tub. The laundry may be discoloured. Use the detergent drawer.
- When washing wool using the Wool cycle, use only a neutral detergent to avoid discolouring the laundry.

NOTE

- Follow the detergent manufacturer's recommendations based on the weight of the laundry, the degree of soiling, and the hardness of the water in your local area. If you are not sure about the water hardness, contact a local water authority.
- Do not use detergent that tends to be hardened or solidified. This detergent may remain after the rinse process, blocking the drain outlet.

Operations

Control panel

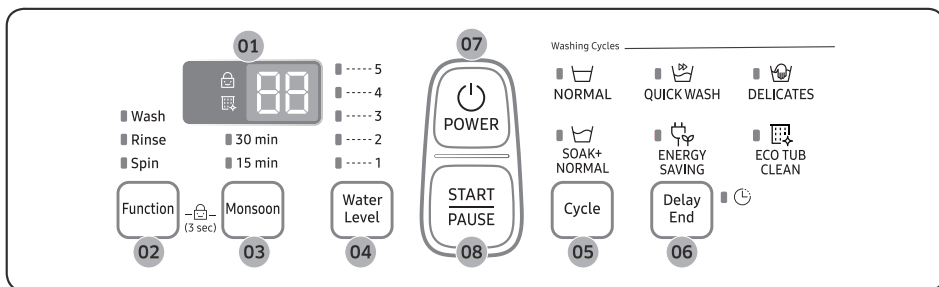

<p>01 Display</p>	<p>Displays the remaining time of a cycle, or the information code when a problem occurs.</p> <p> Child Lock Child Lock is used to prevent children from accidents such as drowning in the tub, and remains active after the machine restarts. To cancel the Child Lock, deactivate it.</p> <p> Eco Tub Clean Use to keep the tub clean. This indicator lights up automatically on a regular basis. When the indicator turns on, run the Eco Tub Clean cycle.</p>
<p>02 Function</p>	<p>Press repeatedly to cycle through the combined processes in this sequence: Wash only > Rinse only > Spin only > Wash+Rinse > Rinse+Spin > Wash+Rinse+Spin > Wash only</p>
<p>03 Monsoon</p>	<p>Use this option to speed up the drying process. Press the button to cycle through the times: 15 min > 30 min</p> <p> NOTE</p> <ul style="list-style-type: none"> • This option is available only when a spinning cycle is selected. • This option is not available with the Delicates or Eco Tub Clean cycle.
<p>04 Water Level</p>	<p>The water level is adjusted according to the cycle. However, you can change the level manually.</p>
<p>05 Cycle</p>	<p>Choose one that best suits your needs.</p>

06 Delay End	Press this button to finish the wash at a specified time. To cancel the Delay End settings, simply turn off the washing machine. You can set the Delay End time up to 24 hours.
07 POWER	Press to turn the washer on or off.
08 START/PAUSE	Press to stop or resume operation. To change the cycle sequence, press once to stop operation, and then change the sequence. To resume operation, press again.

Simple steps to start

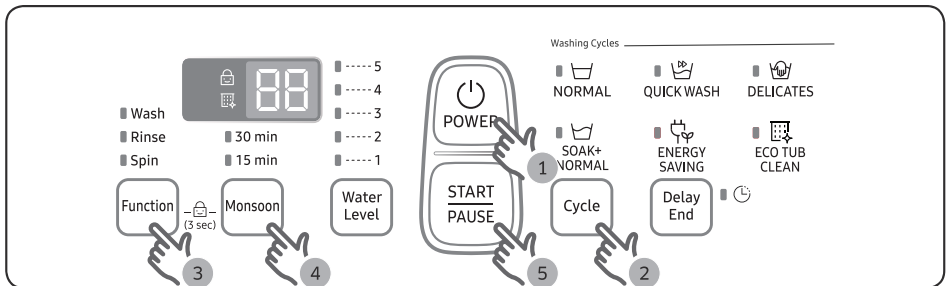

1. Press **POWER** to turn on the washing machine.
2. Select a cycle in the cycle panel.
3. Change the cycle settings (wash, rinse, and/or spinning) as necessary.
4. To add an option such as **Monsoon**, press the corresponding button.
5. Press **START/PAUSE**.

To change the cycle during operation

1. Press **START/PAUSE** to stop operation.
2. Select a different cycle, and repeat steps 2-3 above if necessary.
3. Press **START/PAUSE** again to start the new cycle.

Operations

Auto cycles

Press Cycle repeatedly to cycle through the cycles clockwise: NORMAL > QUICK WASH > DELICATES > SOAK+NORMAL > ENERGY SAVING > ECO TUB CLEAN

Cycle	Description
NORMAL	<ul style="list-style-type: none">Select this for most fabrics including cottons, linens, and normally soiled garments.
QUICK WASH	<ul style="list-style-type: none">Select this for less soiled clothes in reduced time.
DELICATES	<ul style="list-style-type: none">Washable sweater, cardigan, delicate clothes etc.
SOAK+NORMAL	<ul style="list-style-type: none">Press this button to perform a soak wash.Soak time is set up as minutes. Can not change the soak time.
ENERGY SAVING	<ul style="list-style-type: none">Select this to wash effectively with a small amount of energy.
ECO TUB CLEAN	<ul style="list-style-type: none">Select this to clean the tub. The powerful spinning force will remove impurities and bad odours from inside the tub.If you see the  indicator blinking, this indicates that it is recommended to clean the tub using Eco Tub Clean. For details, see the Cleaning section in this manual.

Manual cycles

You might want to use an individual cycle to wash less soiled clothes. For example, you can run the wash cycle once for nightwear.

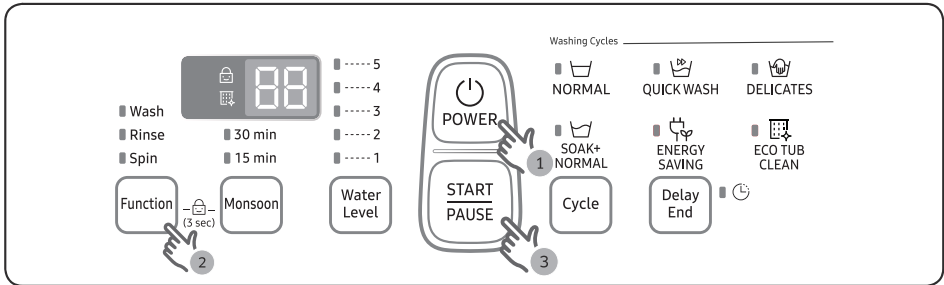

1. Press **POWER** to turn on the washing machine.
2. Press **Function** repeatedly to select an individual cycle (Wash, Rinse, or Spin).
3. Press **START/PAUSE**.

Maintenance

Cleaning

Keep the washing machine clean to prevent deteriorated performance and to preserve its life cycle.

Eco Tub Clean reminder

- The  indicator reminds you of cleaning the tub when necessary. If you happen to see the indicator blinking after washing is complete, remove the laundry and run the Eco Tub Clean cycle.
- You can ignore this reminder and continue to run cycles normally because this is not a system failure. However, the reminder remains active for 6 consecutive cycles immediately after each cycle is complete.
- The reminder is activated once every 1-3 months, depending on the cycle count.
- To keep the tub clean, it is recommended to run Eco Tub Clean on a regular basis.

Magic Filter

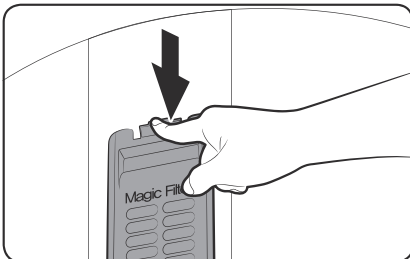

1. Press down the upper area of the filter case to remove.
2. Unlock the cover, and clean the filter with running water and a brush.

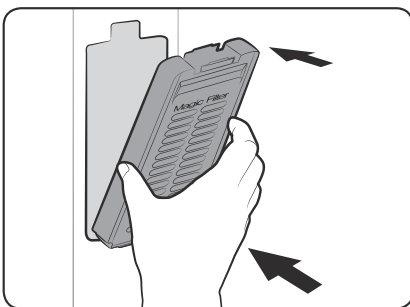

3. When cleaning is complete, close the cover and reinsert the filter case to the original position. You will hear a clicking sound when the filter case fits in.

Pump filter (applicable models only)

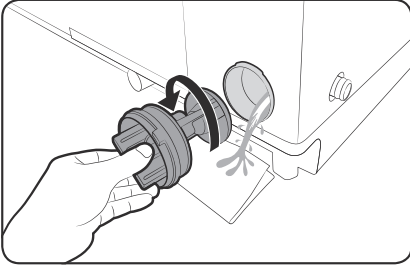

1. Put a floor-cloth or towel under the Pump filter. Turn the filter knob anticlockwise to remove.

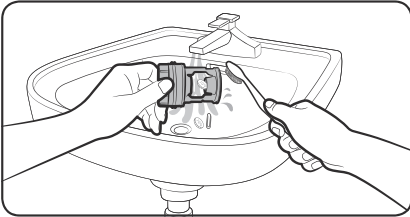

2. Clean the filter with running water and a soft brush.

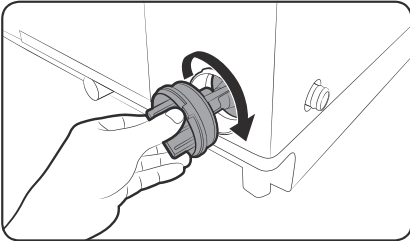

3. Reinsert the filter, and turn clockwise until it locks into position.

Maintenance

Mesh filter

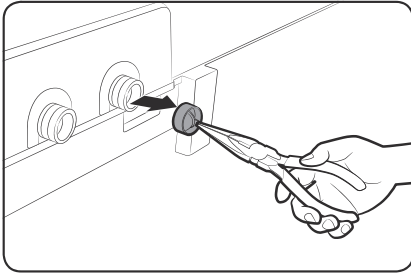

1. Use pliers to pull out the mesh filter from inside the water inlet as shown.
2. Use a soft brush to clean the filter with running water.

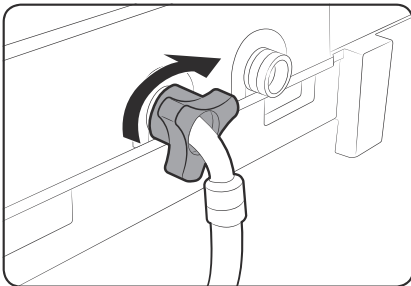

3. Reinsert the filter. Make sure it is tightened against water leaks.

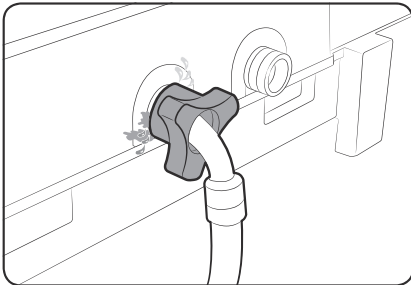

Detergent drawer

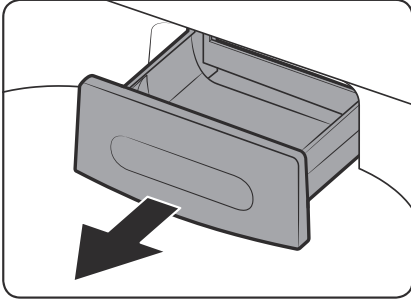

1. Open the door and locate the detergent drawer.
2. Slightly lift up the front edge of the drawer, and then slide it open.

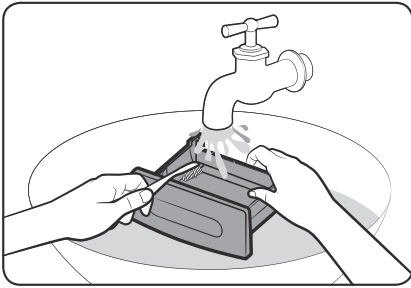

3. Clean the drawer with running water and a soft brush.

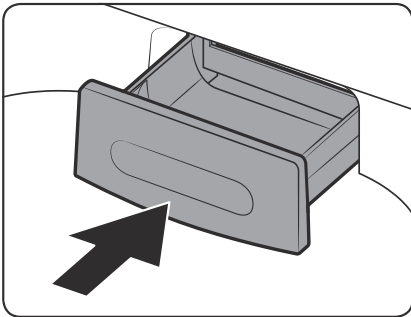

4. When complete, reinsert the detergent drawer.

Troubleshooting

Checkpoints

If you encounter a problem with the washing machine, first check the table below and try the suggestions.

Problem	Action
Does not turn on.	<ul style="list-style-type: none">• Make sure you use rated power for the product.• Make sure the power cord is completely plugged in.• Check the fuse or reset the circuit breaker.
Does not start.	<ul style="list-style-type: none">• Make sure the door is closed.• Make sure the water taps are open.• Make sure to press or tap START/PAUSE to start the washing machine.• Make sure Child Lock is not activated.• Before the washing machine starts to fill, it will make a series of clicking noises to check the door open and does a quick drain.• Was the door opened during the spinning cycle? Close the door, and press or tap START/PAUSE to resume.• The machine enters Standby or is in a soaking cycle. Please wait.• Check the fuse or reset the circuit breaker.
Water is not supplied.	<ul style="list-style-type: none">• Make sure you press or tap START/PAUSE after selecting the water supply.• Make sure the water taps are open.• Is the filter net at the water supply hose connector clogged? Clean the filter net by brushing with a toothbrush.• Is the water supply cut off? If the water supply is cut off, close the tap and power off.• Straighten the water supply hoses.• Open and close the door, then press or tap START/PAUSE.• If the water pressure is low, it takes longer to start washing.• If the water level is not as high as necessary or lower than expected, use the level selector to adjust the water level.
After a cycle, detergent remains in the automatic dispenser.	<ul style="list-style-type: none">• Make sure the washing machine is running with sufficient water pressure.• Make sure the detergent drawer is properly inserted.• Remove and clean the detergent drawer, and then try again.

Problem	Action
Vibrates excessively or makes noise.	<ul style="list-style-type: none"> • Make sure the washing machine is set on a level floor. If the floor is not level, use the levelling feet to adjust the washing machine. • Make sure the washing machine is not contacting any other object. • Make sure the laundry load is balanced. • Make sure the laundry is spread evenly in the washing machine. Spread out the laundry evenly and start again. • Make sure the space around the washing machine is free of objects. • Humming is produced normally during operation. • Objects such as coins can cause noise. Remove these objects from the washing machine after washing is complete.
Stops.	<ul style="list-style-type: none"> • Plug the power cord into a live electrical outlet. • Check the fuse or reset the circuit breaker. • Close the door, and press or tap START/PAUSE to start the washing machine. For your safety, the washing machine will not spin unless the door is closed. • Before the washing machine starts to fill, it will make a series of clicking noises to check the door open and does a quick drain. • There may be a pause or soak period in the cycle. Wait briefly and the washing machine may start. • Make sure the inlet hose screens at the taps are not clogged. Periodically clean the screens. • This problem occurs temporarily due to low voltages, and will be solved when power recovers.
The Eco Tub Clean alarm does not turn off.	<ul style="list-style-type: none"> • When the machine is diagnosed to be cleaned, the  indicator blinks for an hour. This recurs 6 consecutive times until you run the Eco Tub Clean cycle. This is normal, and not a system failure. To keep the tub clean, it is recommended to run the cycle once every 1-3 months.

Troubleshooting

Problem	Action
Fills with the wrong temperature water.	<ul style="list-style-type: none"> • Fully open both water taps. • Make sure the temperature selection is correct. • Make sure the hoses are connected to the correct water taps. Flush water lines. • Disconnect the hoses and clean the screens. The hose filter screens may be clogged. • While the washing machine fills, the water temperature may change as the automatic temperature control feature checks incoming water temperature. This is normal. • While the washing machine fills, you may notice just hot and/or just cold water going through the dispenser when cold or warm temperatures are selected. This is a normal function of the automatic temperature control feature as the washing machine determines the water temperature.
Does not drain and/or spin.	<ul style="list-style-type: none"> • Check the fuse or reset the circuit breaker. • Make sure the electrical voltage is normal. • Make sure the washing machine is plugged in. • Make sure the drain hose is pointed downward. (Natural drain models only) • Make sure the drain hose is not clogged. • Make sure the drain hose is not kinked. • Straighten the drain hose. If there is a drain restriction, call for service. • Close the door, and press or tap START/PAUSE. For your safety, the washing machine will not spin unless the door is closed.
Load is wet at the end of the cycle.	<ul style="list-style-type: none"> • Use the High or Extra High spin speed. (Applicable model only) • Use high efficiency (HE) detergent to reduce oversudsing. • Load is too small. Small loads (one or two items) may become unbalanced and not spin completely.

Problem	Action
Leaks water.	<ul style="list-style-type: none"> • Make sure all hose connections are tight. • Make sure the water supply hose's rubber packing is in the correct position. Screw tightly again. • Make sure the end of the drain hose is correctly inserted and secured to the drain system. • Avoid overloading. • Use high efficiency (HE) detergent to prevent oversudsing. • Make sure the water supply hose is not kinked. • If the water supply is too strong, water may leak. Close the water tap a little. • Make sure water is not leaking from the water tap. If so, repair the water tap.
Excessive suds.	<ul style="list-style-type: none"> • Use high efficiency (HE) detergent to prevent oversudsing. • Reduce the detergent amount for soft water, small loads, or lightly soiled loads. • Non-HE detergent is not recommended.
The spin basket or drain/supply hose is frozen.	<ul style="list-style-type: none"> • Use warm water to disconnect the water supply hose and drain hose. Soak them in warm water. • Fill the spin basket with warm water, and then wait for about 10 minutes. • Put a hot towel on the drain hose connector. • Reconnect the water supply hose and drain hose, and check if water is supplied properly.
Water drains out immediately.	<ul style="list-style-type: none"> • Make sure the drain hose is not clogged, and is hung over the drain hose hook. Fill the spin basket halfway with water, and try spinning again. • Lift the end of the drain hose to prevent water from draining. Fill the spin basket halfway with water, and then run spinning after releasing the drain hose. • Make sure the drain hose is installed correctly. See the installation section of this user manual and adjust the position of the drain hose as instructed.
Stains on clothes.	<ul style="list-style-type: none"> • Clean the magic filter.
Has odours.	<ul style="list-style-type: none"> • Excessive suds collect in recesses and can cause foul odours. • Run cleansing cycles to sanitize periodically. • Dry the washing machine interior after a cycle has finished.

If a problem persists, contact a local Samsung service centre.

Troubleshooting

Information codes

If the washing machine fails to operate, you may see an information code on the display. Check the table below and try the suggestions.

Code	Action
1C	The WaterLevel sensor is not working properly. <ul style="list-style-type: none">• Check WaterLevel Sensor wire harness.• If the information code remains, contact a customer service centre.
3C	Motor problem. <ul style="list-style-type: none">• Try restarting the cycle.• If the problem continues, call for service.
4C	Water is not supplied. <ul style="list-style-type: none">• Make sure the water taps are open.• Make sure the water hoses are not clogged.• Make sure the water taps are not frozen.• Make sure the washing machine is operating with sufficient water pressure.• Make sure that the cold water tap and the hot water tap are properly connected.• Clean the mesh filter as it may be clogged.
5C	Water is not draining. <ul style="list-style-type: none">• Make sure the drain hose is not frozen or clogged.• Make sure the drain hose is positioned correctly, depending on the connection type.• Clean the debris filter as it may be clogged.• Make sure the drain hose is straightened all the way to the drain system.• If the information code remains, contact a customer service centre.
dC	Operating the washer with the door open. <ul style="list-style-type: none">• Make sure the door is properly closed.• Make sure laundry is not caught in the door.
LC	Check the drain hose. <ul style="list-style-type: none">• Make sure the end of the drain hose is placed on the floor.• If the information code remains, contact a customer service centre.

Code	Action
OC	<p>Water is overflowed.</p> <ul style="list-style-type: none"> • Power off and restart the spinning process to drain water • If the information code remains on the display, contact a local Samsung service centre.
Ub	<p>Spinning does not work.</p> <ul style="list-style-type: none"> • Make sure laundry is spread out evenly. • Make sure the washing machine is on a flat, stable surface. • Redistribute the load. If only one item of clothing needs washing, such as a bathrobe or pair of jeans, the final spin result might be unsatisfactory, and an “Ub” check message will be shown in the display.

If any information code keeps appearing on the screen, contact a local Samsung service centre.

Specifications

Specification sheet

Type		Top loading washing machine	
		WA75A40****	WA70A40****
Max load (kg)		7.5	7.0
Power consumption (W)	WASH	330	
	SPIN	240	
Dimensions (mm)		W540 x D568 x H926 HIGH BASE	
Net weight (kg)		30	
Water pressure (MPa (kg-f/cm ²))		0.05-0.78 (0.5-8.0)	
Washing type		Stirring type	
Water level (L)	5	60 L	
	4	52 L	
	3	46 L	
	2	38 L	
	1	30 L	
Water usage (L)		160 L	
Spin speed (rpm)		680	

Type		Top loading washing machine	
		WA65A40****	
Max load (kg)		6.5	
Power consumption (W)	WASH	330	
	SPIN	240	
Dimensions (mm)		W540 x D568 x H906 LOW BASE	
Net weight (kg)		29.5	
Water pressure (MPa (kg-f/cm ²))		0.05-0.78 (0.5-8.0)	
Washing type		Stirring type	
Water level (L)	5	60 L	
	4	52 L	
	3	46 L	
	2	38 L	
	1	30 L	
Water usage (L)		160 L	
Spin speed (rpm)		680	

NOTE

- Asterisk (*) means variant model and can be varied (0-9) or (A-Z).
- The design and specifications are subject to change without notice for quality improvement purposes.

Terms of Warranty

Warranty not applicable in any of the following cases

1. The Complete warranty Card is not presented to the service engineer at the time of repairs being undertaken/ requested.
2. The Product is not purchased from an Authorized Samsung Sales Dealer.
3. The Product purchased is not used according to the instruction given in the INSTRUCTION MANUAL as determined by company personnel.
4. Defect Caused by improper use, as determined by the authorized service centers/ Company Personnel.
5. Modification or alterations of any nature made in the circuitry by the Purchaser or unauthorized Personnel, as determined by Company personnel.
6. The Warranty is not applicable if the washing machine used for commercial purpose or Public places like Hotels, training centers and other similar applications.
7. The Original Serial number is removed, obliterated or altered from the Product.
8. Defect due to causes beyond control like lightening, abnormal voltage, acts of god or while in transit to service center or to the purchaser residence.
9. Correcting the installation for example leveling the product, adjustment of drain hose, Adjustment of Tap adopter.
10. Noise or Vibration that is considered as normal for example water drain sound, spin sound or warning beeps.
11. Removal of foreign objects/substances from machine, including the Drain Valve and inlet hose filter for example coin, Grit, safety pin, buttons, hooks, Dirt accumulation etc.
12. Replace fuse, correcting house wiring, house plumbing and defect or damage caused by household pets, rats, cockroaches or any other animals or insects.

For warranty conditions refer warranty card.

QUESTIONS OR COMMENTS?

COUNTRY	CALL	OR VISIT US ONLINE AT
INDIA	1800 40 SAMSUNG (1800 40 7267864 - Toll Free) 1800 5 SAMSUNG (1800 5 7267864 - Toll Free)	www.samsung.com/in/support

This product is RoHS compliant.

