

SPECIFICATIONS

BO-661MRT

Power consumption	230V AC 50Hz, 3000 W	Grill Heating Element
Operating frequency	50Hz	Convection Heating Element
Oven capacity		Net weight
Top Heating Element		Outside Dimension (WxDxH) 595x575x595
Bottom Heating Element		Oven cavity Dimensions (WxDxH) 560x570x600

*Subject to change without prior notice.

WARRANTY

This GLEN Built-in Oven is fully warranted against any defect arising out of defective materials or faulty workmanship for a period of one year from the date of purchase. Should any defect develop in this product, the customer should bring the product to the nearest authorised service centre, where the company undertakes to get the product repaired free of charge.

This warranty is not valid if:

- The use and care instructions have not been followed.
- Defects are caused by accident, misuse, abuse or commercial use.
- The repair work is carried out by persons not authorised by the company.
- Any modification or alteration of any nature is made in the product.
- Normal wear & tear of the product is not covered under warranty
- The Bill/Cash memo and copy of warranty card is not presented.

Under no circumstances, whether based on limited warranty or otherwise shall the company be liable for incidental, special or consequential damages. Use of product indicates acceptance by you of the aforesaid terms and conditions.

PRODUCT NAME : BUILT-IN OVEN

MODEL NO.: BO-661MRT

SERIAL NO.: _____

BILL NO. & DATE: _____

NAME OF OWNER: _____

ADDRESS: _____

DEALER'S STAMP & SIGNATURE

Glen Appliances Pvt. Ltd.

I-34, DLF Ind. Area, Phase-I, Faridabad-121003, India, Service Helpline : 9266655555
E-mail : service@glenindia.com, info@glenindia.com Website : www.glenindia.com

BUILT-IN OVEN BO-661MRT

GLEN

Live Better !

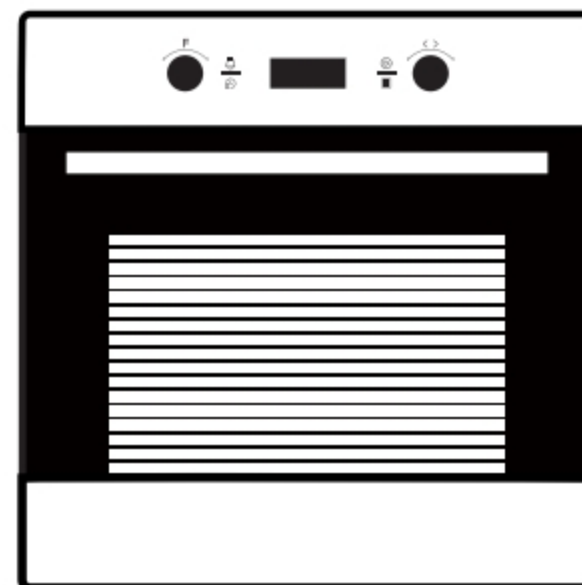

ACKNOWLEDGMENT

Thank you for purchasing our product. We hope you enjoy using the many features and benefits it provides. Before using this product please study this entire Instruction Manual carefully. Keep this manual in a safe place for future reference. Ensure that other people using the product are familiar with these instructions as well.

WARNING

- When the oven is first switched on, it may give off an unpleasant smell. This is due to the bonding agent used for the insulating panels within the oven. Please run up the new empty product with the conventional cooking function, 250°C, 90 minutes to clean oil impurities inside the cavity.
- During the first use, it is completely normal that there will be a slight smoke and odors. If it does occur, you merely have wait for the smell to clear before putting food into the oven.
- Please use the product under the open environment. The appliance and it's accessible parts become hot during use. Care should be taken to avoid touching heating elements. Children less than 8 years of age shall be kept away unless continuously supervised.
- If the surface is cracked, switch off the appliance to avoid the possibility of electric shock.
- This appliance can be used by children aged from 8 years and above and persons with reduced physical, sensory or mental capabilities or lack of experience and knowledge if they have been given supervision or instruction concerning use of the appliance in a safe way and understand the hazards involved. Children shall not play with the appliance. Cleaning and user maintenance shall not be made by children without supervision.
- During use, the appliance becomes very hot. Care should be taken to avoid touching heating elements inside the oven.
- Do not allow children to go near the oven when it is operating, especially when the grill is on.
- Ensure that the appliance is switched off before replacing the oven lamp to avoid the possibility of electric shock.
- The means for disconnection must be incorporated in the fixed wiring in accordance with the wiring specifications.
- Children should be supervised to ensure that they do not play with the appliance.
- This appliance is not intended for use by persons (including children) with reduced physical, sensory or mental capabilities, or lack of experience and knowledge, unless they have been given supervision or instruction concerning use of the appliance by person responsible for their safety.
- Accessible parts may become hot during use. Young children should be kept away.

- An all-pole disconnection means must be incorporated in the fixed wiring in accordance with the wiring rules.
- If the supply cord is damaged, it must be replaced by the manufacturer, its service agent or similarly qualified persons in order to avoid a hazard.
- Do not use harsh abrasive cleaners or sharp metal scrapers to clean the oven door glass since they can scratch the surface, which may result in shattering of the glass.
- A steam cleaner is not to be used.
- The appliances are not intended to be operated by means of an external timer or separate remote-control system.
- The instructions for ovens that have shelves shall include details indicating the correct installations of the shelves.

SAFETY HINTS

- Do not use the oven unless you are wearing something on your feet. Do not touch the oven with wet or damp hands or feet.
- For oven: Oven door should not be opened often during the cooking period.
- The appliance must be installed by an authorized technician and put into use. The producer is not responsible for any damage that might be caused by defective placement, and installation by unauthorized personnel.
- When the door or drawer of oven is open do not leave anything on it, you may unbalance your appliance or break the door.
- Some parts of appliance may keep its heat for a long time; it is required to wait for it to cool down before touching onto the points that are exposed to the heat directly.
- If you will not use the appliance for a long time, it is advised to plug it off.

FITTING THE OVEN INTO THE KITCHEN UNIT

Fit the oven into the space provided in the kitchen unit; it may be fitted underneath a work top or into an upright cupboard. Fix the oven in position by screwing into place, using the two fixing holes in the frame. To locate the fixing holes, open the oven door and look inside. To allow adequate ventilation, the measurements and distances adhered to when fixing the oven.

IMPORTANT

If the oven is to work properly, the kitchen housing must be suitable. The panels of the kitchen unit that are next to the oven must be made of a heat resistant material. Ensure that the glues of units that are made of veneered wood can withstand temperatures of at least 120°C. Plastics or glues that cannot withstand such temperatures will melt and deform the unit, once the oven has been lodged inside the units, electrical parts must be completely insulated. This is a legal safety requirement. All guards must be firmly fixed into place so that it is impossible to remove them without using special tools. Remove the back of the kitchen unit to ensure an adequate current of air circulates around the oven. The hob must have a rear gap of at least 45 mm.

DECLARATION OF COMPLIANCE

When you have unpacked the oven, make sure that it has not been damaged in any way. If you have any doubts at all, do not use it: contact a professionally qualified person. Keep packing materials such as plastic bags, polystyrene, or nails out of the reach of children because these are dangerous to children.



PRODUCT DESCRIPTION

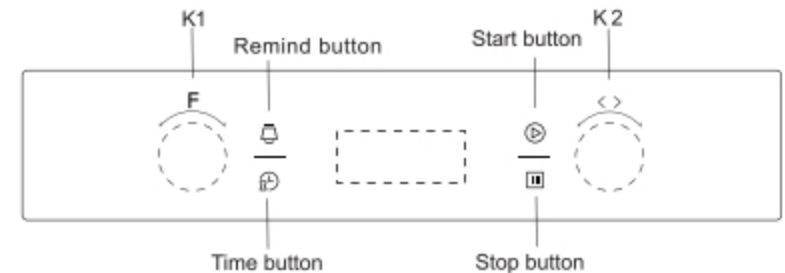

Symbol	Function Description
	Oven Lamp: Which enables the user to observe the progress of cooking without opening the door. Oven lamp will light for all cooking functions.
	Defrost: The circulation of air at room temperature enables quicker thawing of frozen food, (without the use of any heat). It's a gentle but quick way to speed up the defrosting time and thawing of ready-made dishes and cream filled produce etc.
	Bottom heater: A concealed element in the bottom of the oven provides heat. It is mainly used for keeping food warm. The temperature can be set within the range of 60-120°C. The default temperature is 60°C.
	Conventional cooking: The top and bottom work together to provide convectional cooking. The temperature can be set within the range of 50-250°C. The default temperature is 220°C.
	Convection with fan: Combination of the fan and both heating element provides more even heat penetration, saving up to 30-40% of energy. Dishes are lightly browned on the outside and still moist on the inside. Note: This function is suitable for grilling or roasting big pieces of meat at a higher temperature. The temperature can be set within the range of 50-250°C. The default temperature is 220°C.
	Radiant grilling: The inner grill element switches on and off to maintain temperature. The temperature can be set within the range of 180-240°C. The default temperature is 210°C.
	Double grilling: The inside radiant element and top element are working. The temperature can be set within the range of 180-240°C. The default temperature is 210°C.
	Double grilling with fan: The inside radiant element and top element are working with fan. The temperature can be set within the range of 180-240°C. The default temperature is 210°C.
	Convection: An element around the convection fan provides an additional source of heat for convection style cooking. In convection mode the fan automatically comes on to improve air circulation within the oven and creates an even heat for cooking. The temperature can be set within the range of 50-240°C. The default temperature is 180°C.

OPERATION INSTRUCTIONS

1. Clock Setting

After connecting the unit to the power, the symbols "0:00" will be visible on the display.

- 1> Press "⏸", the hour figures will flash.
- 2> Rotate "K2" to adjust the hour figures, (time should be within 0--23).
- 3> Press "⏸", the minutes will flash.
- 4> Rotate "K2" to adjust the minutes setting, (time should be within 0--59).
- 5> Press "⏸" to finish the clock settings. ":" will flash, and the time will be illuminated.

Note: The clock is 24 hours. After power on, if not set, the clock will show "0:00".

2. Function Setting

- 1> Rotate "K1" to choose the cooking function you require. The related symbol will be illuminated.
- 2> Rotate "K2" to adjust the temperature.
- 3> Press "⏸" to confirm the start of cooking.
- 4> If step 2 is ignored, Press "⏸" to confirm the start of cooking and the default time is 9 hours, the default temperature will display on the LED.

NOTE:

- 1> The step quantities for the adjustment time of the knobs are as follow:
0--0:30min: step 1 minute 0:30--9:00hour: step 5 minutes
- 2> The step quantities for the adjustment of temperature is 5°C, and the grill function is 30°C.
- 3> Rotate "K1" to adjust the cooking time when cooking begins. Then press "⏸" to confirm. If "⏸" not pressed within 3 seconds, the oven will revert back to the previous time to continue cooking.
- 4> Rotate "K2" to adjust the temperature when cooking begins. The related indicator will be illuminated. Then press "⏸" to start cooking. If "⏸" not pressed in 3 seconds, the oven will revert back to the previous temperature to continue cooking.

3. Lamp Setting

- 1> Rotate "K1" to select the relevant function, then the corresponding icon will be on.
- 2> Press "⏸" button to start, "0:00" and lamp icon "💡" will light up, ":" will flash.

4. Inquiring Function

In the following states, you can use inquiring function, after 3 seconds return to the current state.

- 1> During working state, if the clock was set, press "⏸" button to see the current time; if the reminder function was set, press "🕒" button to see the time of reminder.
- 2> In reminding state, if the clock was set, press "⏸" button to see the current time.
- 3> In clock display state, if the reservation function was set, press "🕒" button to see the time of reservation.

5. Child lock Function

To Lock: press "🔒" and "🔒" simultaneously for 3 seconds, there will be a long "beeping" sound and the "🔒" will be illuminated. Lock quitting: press "🔒" and "🔒" simultaneously for 3 seconds, there will be a long "beeping" sound indicating the child-lock is released.

Note: During working mode, if you want to stop cooking, press stop button quickly. Do not need to long pressing on stop button, it is invalid.

6. Reminder Function

This function will help to remind you to start cooking in a certain time from 0:01 to 9:59. Only when oven in standby mode, the reminder can be set. Follow below to set the reminder:

- 1> Press reminder setting button "🕒";
- 2> Rotate "K2" to set the hour time of reminder. (Time should be within 0--9).
- 3> Press reminder setting button "🕒" again;
- 4> Rotate "K2" to set minute time of reminder. (Time should be within 0--59).
- 5> Press "⏸" to confirm setting. The time will count down.

Note: The oven buzzer will sound for 10 times after the time back to the zero hour. You can cancel the reminder during setting by pressing the stop button; After the reminder has been set, you can cancel it by pressing stop button twice.

7. Start/Pause/Cancel Function

- 1> If the cooking time has been set, press "⏸" to start cooking. If the cooking is paused, press "⏸" to resume cooking.
- 2> During cooking process, press "⏸" once to pause the cooking. Press "⏸" twice to cancel the cooking.

8. Energy-Saving Function

- 1> In waiting state and reminding state, press "⏸" for three seconds, the LED display will go off and set to energy-saving mode.
- 2> If no operation in 10 minutes under waiting state, the LED display will go off and go into energy-saving mode.
- 3> Under the energy-saving mode, press any key or rotate any knob can quit the energy-saving mode.

9. Reservation Function

- 1> To use reservation function, clock must be set in advance. Then, in the way of setting the clock, reserved time that oven starts to cook must be set (a> Press reservation setting button "🕒"; b> Rotate "K2" to set the hour time of reservation. Time should be within 0--23. c> Press reservation setting button "🕒" again; d> Rotate "K2" to set minute time of reservation. Time should be within 0--59.), but don't press clock this time. Next, turn knob "K1" to choose function.
- 2> Press "⏸" button to set cooking time and temperature. Then turn knob "K1" to adjust time, and "K2" to adjust temperature.

3> Press the "⏸" button to finish cooking setting, and the clock will be on the screen with reservation sign "⏸" always lighting. But no other function signals are presented. Reservation time can be checked by pressing "⏸", 3 seconds later the screen will show clock again.

4> At the time of reservation, cooking will start automatically after a buzzing sound. The reservation symbol "⏸" will put out, and other indicating signs will work normally.

Note:

- 1> Lamp, defrost, probe can't be reserved.
- 2> During the status of reservation, press cancel button once, time and temperature of reservation menu will be shown with menu icon lighting constantly. Press again, screen returns to clock, or press start button to return to reservation status.
- 3> Reminder function is invalid during reservation status.

10. Note

- 1> The oven lamp will be on for all functions.
- 2> Once the cooking programme has been set and the "⏸" button is not pressed within 5 minutes, the current time will be displayed or turn back to waiting state. The setting program will be invalid.
- 3> The buzzer will sound once when effectively pressed, if not effectively pressed there will be no response.
- 4> The buzzer will sound five times to remind you when cooking has finished.

ACCESSORIES

Wire Shelf : For grill, dishes, cake pan with items for roasting and grilling.



Slider Bracket : For cooking larger size food, these shelf support rails on the right and left sides of the oven can be removed, dishes and tray can be put on the oven floor, using functions as Radiant grilling, Double grilling, Double grill with fan.



NOTE: When placing dishes on the oven floor, please DO NOT use functions with bottom heater to prevent heat gathering at bottom. (only for specific models)

Telescopic Runner: Some models might with telescopic runners to facilitate the use of oven. These telescopic runners and slider brackets could be disassembled by unscrewing the screws used to fix it. After disassembled, dishes and tray can be put on the oven floor, using functions as Radiant grilling, Double grilling, Double grill with fan. NOTE: When placing dishes on the oven floor, please DO NOT use functions with bottom heater to prevent heat gathering at bottom. (only for specific models)



Universal Pan: For cooking large quantities of food such as moist cakes, pastries, frozen food etc, or for collecting fat/ spillage and meat juices.

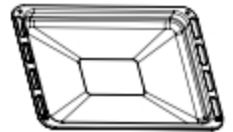

SHELF PLACEMENT WARNING:

To ensure the oven shelves operate safely, correct placement of the shelves between the side rail is imperative. Shelves and the pan only can be used between the first and fifth layers. The shelves should be used with the right direction, it will ensure that during careful removal of the shelf or tray, hot food items should not slide out.

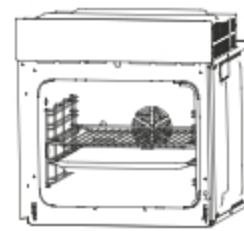

OR

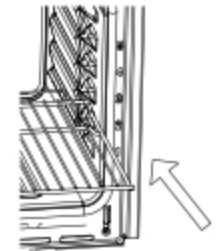

BULB REPLACEMENT

For replacement, process as follows:

- 1> Disconnect power from the mains outlet or switch off the circuit breaker of the unit's mains outlet.
- 2> Unscrew the glass lamp cover by turning it counter-clockwise (note, it may be stiff) and replace the bulb with a new one of the same type.
- 3> Screw the glass lamp cover back in place.

NOTE: Only use 25-40W/220V-240V , T300°C halogen lamps.

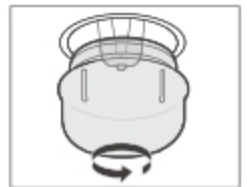

SECURING THE OVEN TO THE CABINET

- 1> Fit oven into the cabinet recess.
- 2> Open the oven door.
- 3> Secure the oven to the kitchen cabinet with two distance holders "A" which fit the holes in the oven frame and fit the two screws "B".

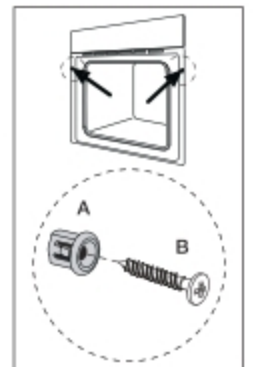

VENTILATING OPENINGS

When cooking is finished or in pause state or in waiting state, if the oven's center temperature is over 75 degree, the cooling fan will continue working for 15 minutes. Or when the oven's center temperature becomes lower than 75 degree, the cooling fan will stop in advance.

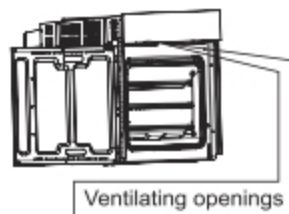

CONNECTION OF THE OVEN

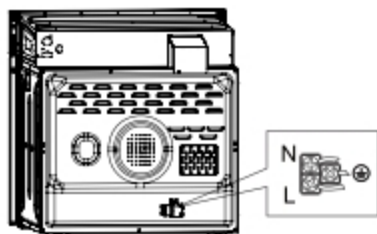

INSTALLATION

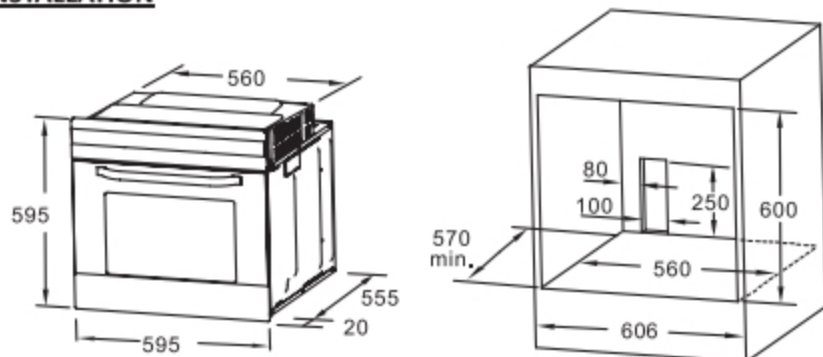

Remark: 1. Only plus deviations are admissible for all dimension.

2. The cabinet is not include the power switch or socket.

NOTE: The number of accessories included depends on the particular appliance purchased.

REMOVING THE DOOR FROM OVEN (OPTIONAL)

Removable door allows full access to entire interior of the oven for easier and quicker maintenance.

1. To remove the door, open the door to the maximum angle. Then pull the buckle at the door hinge backward. (Figure 1)
2. Close the door to an angle approximately 15°. Lift up and slowly pull the door out from the oven. (Figure 2)
3. Place the door flatwise with door top cover towards yourself, put your hands on the glass and pull it towards the oven. (Figure 3)
4. Separate the glass carefully by lifting it approximately 25°. (Figure 4)
5. Push the glass into the position indicated by the arrow in Figure 5. Gently pull the glass out of the socket.

6. After pulling out the inner glass, please take out the middle layer glass as shown in Figure 6.
7. When cleaning is completed, reverse the above procedures to return the door to its original position.



Figure 1

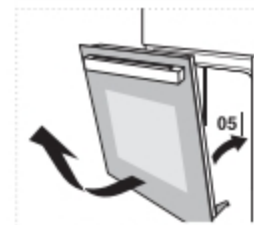

Figure 2



Figure 3

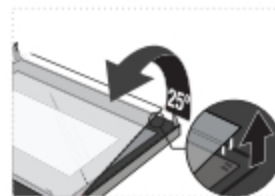

Figure 4

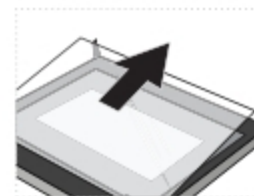

Figure 5

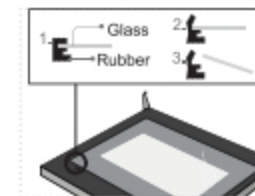

Figure 6

CLEANING AND MAINTENANCE

For the sake of a good appearance and reliability, keep the unit clean. The modern design of the unit facilitates maintenance to a minimum. The parts of the unit which come into contact with food have to be cleaned regularly.

- Before any maintenance and cleaning, disconnect the power.
- Set all controls in the OFF position.
- Wait until the inside of the unit is not hot but only slightly warm- cleaning is easier than when warm. Clean the surface of the unit with a damp cloth, soft brush or fine sponge and then wipe dry. In case of heavy soiling, use hot water with non- abrasive cleaning product.
- For cleaning the glass of the oven door, do not use abrasive cleaners or sharp metal scrapers, these can scratch the surface or lead to the glass being damaged.
- Never leave acidic substances (lemon juice, vinegar) on stainless steel parts.
- Do not use a high pressure cleaner for cleaning the unit. The baking pans may be washed in mild detergent.

This appliance is marked according to the European directive 2012/19/EU on Waste Electrical and Electronic Equipment (WEEE). By ensuring this product is disposed correctly, you will help prevent potential negative consequences for the environment and human health, which could otherwise be caused by inappropriate waste handling of this product. The symbol on the product indicates that this product may not be treated as household waste. Instead it shall be handed over to the applicable collection point for the recycling of electrical and electronic equipment. Disposal must be carried out in accordance with local environmental regulations for waste disposal. For more detailed information about treatment, recovery and recycling of this product, please contact your local city office, your household waste disposal service or the shop where you purchased the product.

