



RAZER TARTARUS V2

MASTER GUIDE

The **Razer Tartarus V2** provides endless commands at your fingertips with 32 fully programmable mecha-membrane keys, including an 8-way directional D-pad and 3-way scroll wheel. The keypad also features individually programmable backlit keys with 16.8 million color options, all easily set through Razer Synapse. And with its improved ergonomic form factor and adjustable palm rest with two positions, you get the exact angle of comfort you need.

CONTENTS

1. WHAT'S INSIDE / WHAT'S NEEDED.....	3
2. LET'S GET YOU COVERED.....	5
3. TECHNICAL SPECIFICATIONS.....	6
4. SETTING UP YOUR RAZER TARTARUS V2	7
5. USING YOUR RAZER TARTARUS V2	8
6. CONFIGURING YOUR RAZER TARTARUS V2 VIA RAZER SYNAPSE.....	10
7. SAFETY AND MAINTENANCE	23
8. LEGALESE.....	25

1. WHAT'S INSIDE / WHAT'S NEEDED

WHAT'S INSIDE

- Razer Tartarus V2 gaming keypad

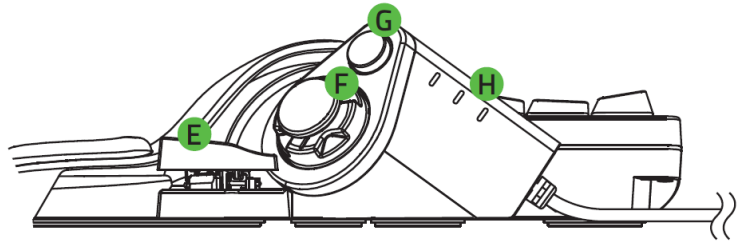
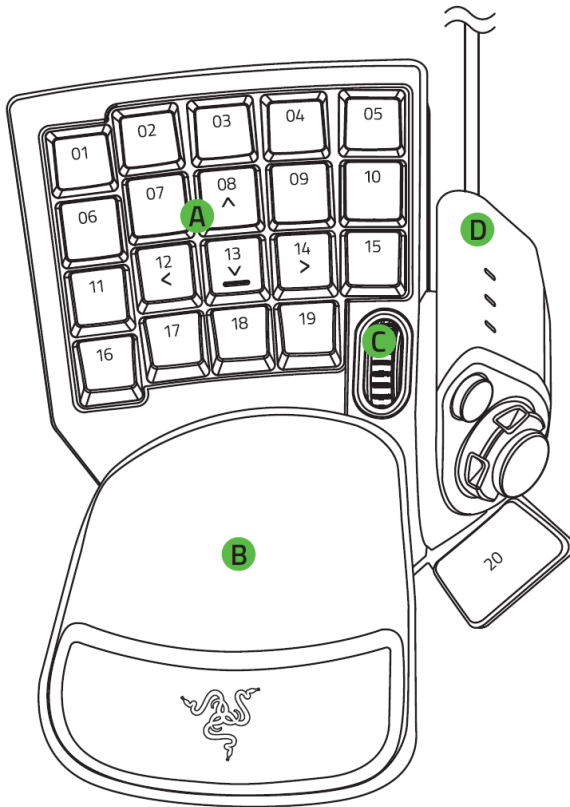

- A. 19 backlit keys
- B. Adjustable palm rest
- C. Scroll wheel
- D. Thumb module
- E. Spacebar actuator
- F. 8-way directional thumb pad

- G. Hyperresponse thumb key
- H. Keymap indicator

- Important Product Information Guide

WHAT'S NEEDED

PRODUCT REQUIREMENTS

- PC with a free USB port

RAZER SYNAPSE REQUIREMENTS

- Windows® 7 64-bit (or higher)
- Internet connection for software installation

2. LET'S GET YOU COVERED

You've got a great device in your hands, complete with a 1-year limited warranty coverage. Now maximize its potential and score exclusive Razer benefits by registering at razerid.razer.com

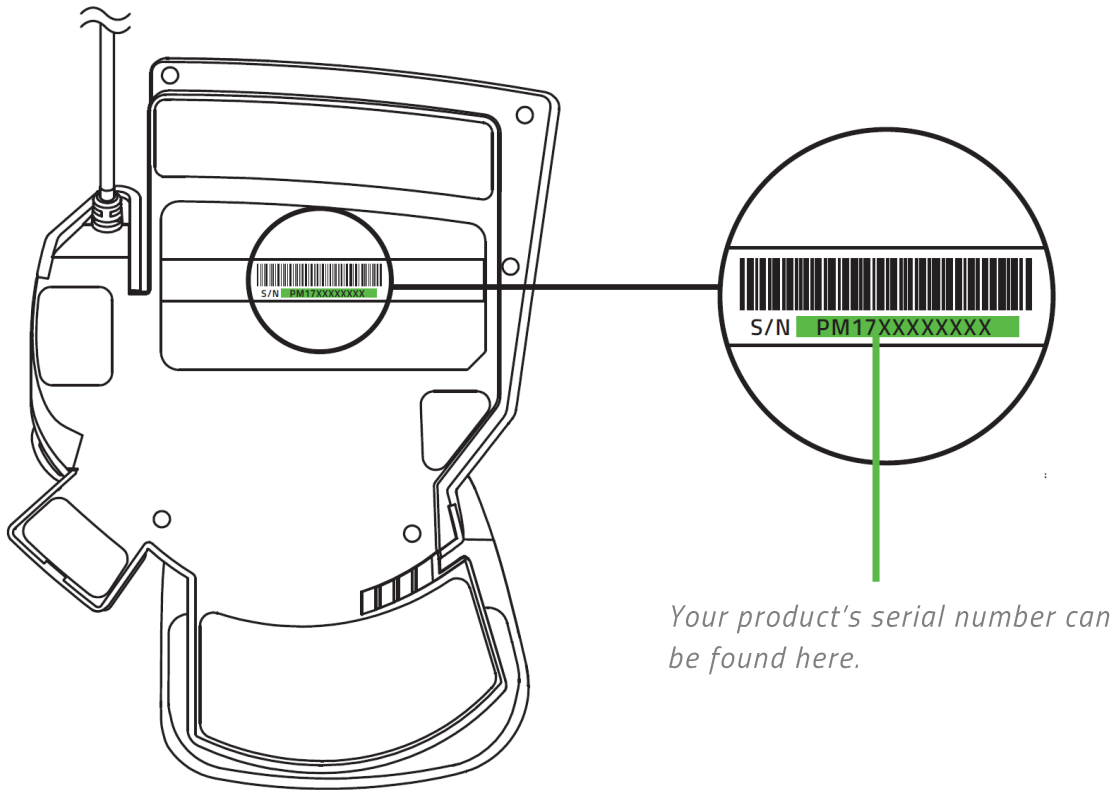

Your product's serial number can be found here.

Got a question? Ask the Razer Support Team at support.razer.com

3. TECHNICAL SPECIFICATIONS

TECHNICAL SPECIFICATIONS

- Razer™ Mecha-Membrane Technology
- Mid height keycaps
- Razer Chroma™ backlighting with 16.8 million customizable color options
- 32 fully programmable keys
- Programmable 8-way directional thumbpad & scroll wheel
- Full anti-ghosting
- Unlimited macro lengths
- Unlimited game profiles
- Ergonomic form factor with adjustable palm rest
- Razer Synapse enabled
- 1000Hz Ultrapolling
- Braided fiber cable

APPROXIMATE SIZE & WEIGHT

- Length: 150 mm / 5.90 in
- Height: 203 mm / 7.99 in
- Depth: 59.6 mm / 2.34 in
- Weight: 340 g / 0.749 lbs

4. SETTING UP YOUR RAZER TARTARUS V2

1. Connect your Razer device to the USB port of your computer

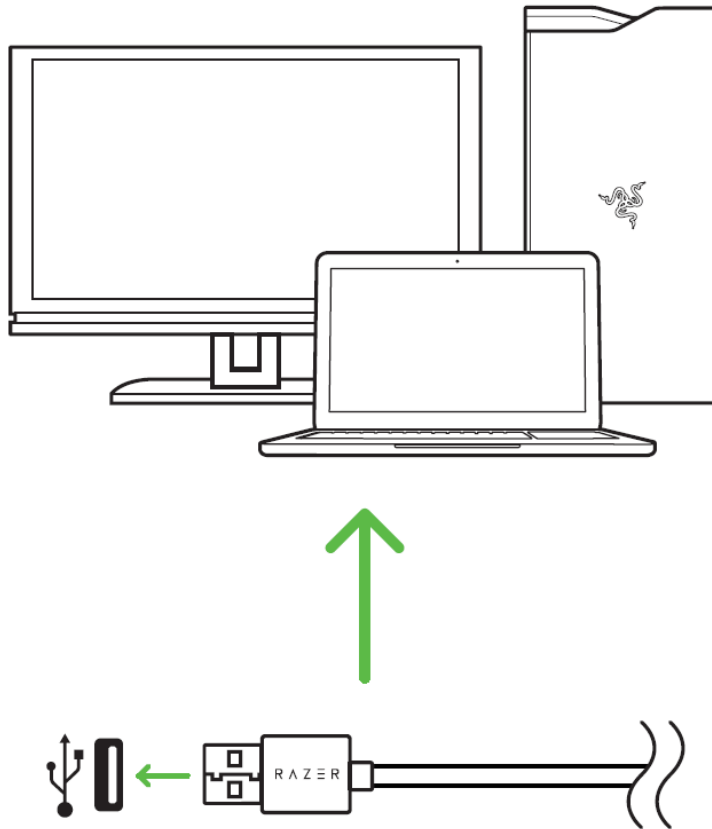

2. Install Razer Synapse when prompted or download the installer from [razer.com/synapse](https://www.razer.com/synapse).

5. USING YOUR RAZER TARTARUS V2

DEFAULT KEYPAD MAPPING

By default, the keys and the thumb module of your Razer Tartarus V2 have the following key assignments below.

Backlit keys

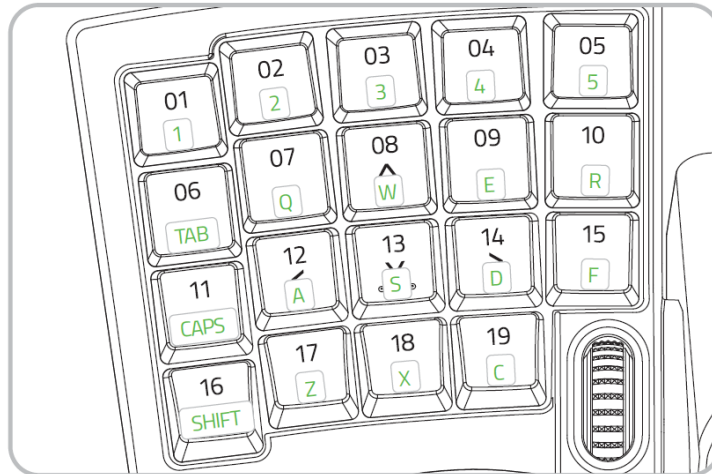

Thumb Module

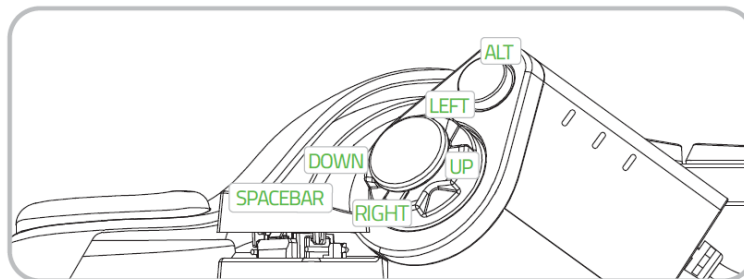

ADJUSTING THE PALM REST

You can remove the palm rest and adjust it accordingly to improve your overall gaming comfort. To do this, firmly hold your Razer keypad, then lift and reattach the palm rest to your preferred position using your other hand.

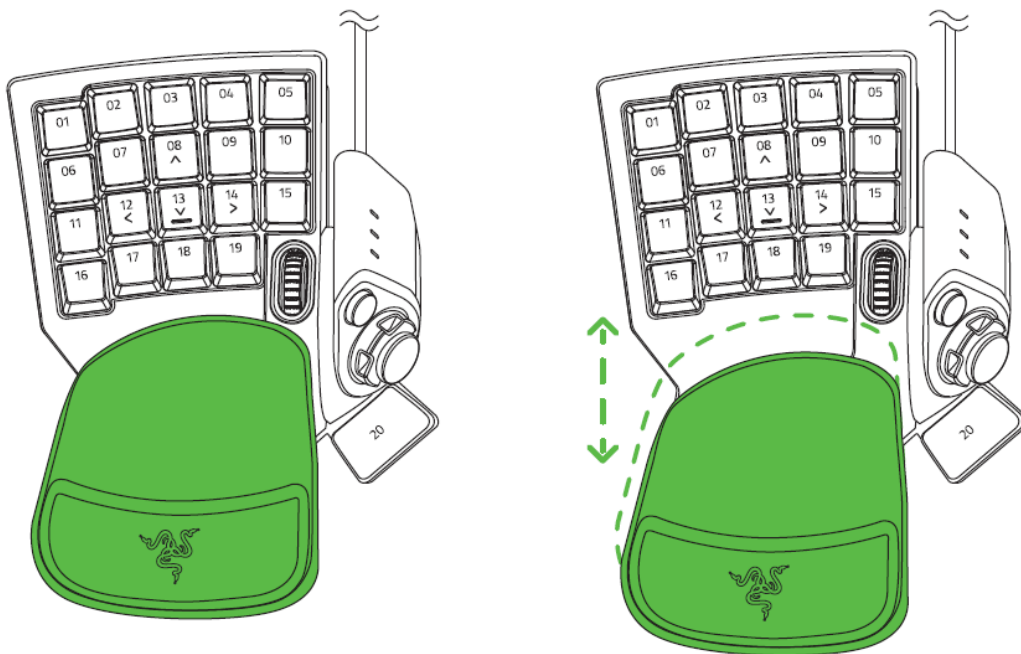
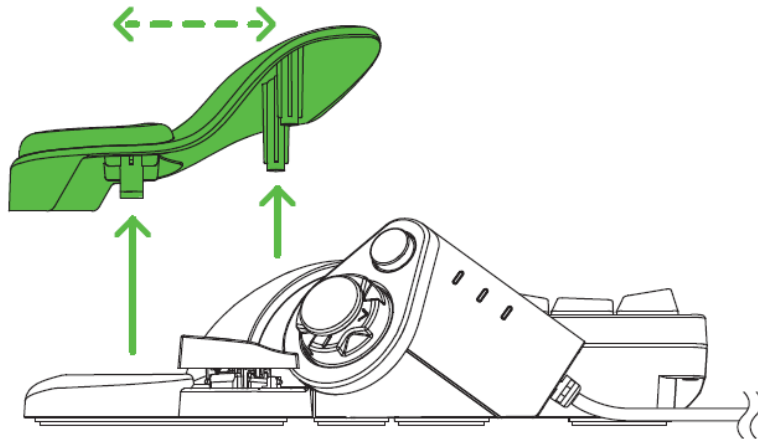

CUSTOMIZING THE 8-WAY DIRECTIONAL THUMB PAD

You can customize the 8-way directional thumb pad if you prefer using directional buttons instead of the thumb stick. To do this, simply remove the thumb stick from the thumb pad.

6. CONFIGURING YOUR RAZER TARTARUS V2 VIA RAZER SYNAPSE

i *Disclaimer: Internet connection is required for installation, updates and cloud-based features. Registering for a Razer ID account is recommended, but optional. All listed features are subject to change based on the current software version, connected device(s), and supported apps and software.*

SYNAPSE TAB

The Synapse tab is your default tab when you first launch Razer Synapse.

Dashboard

The Dashboard subtab is an overview of your Razer Synapse where you can access all your Razer devices, modules, and online services.

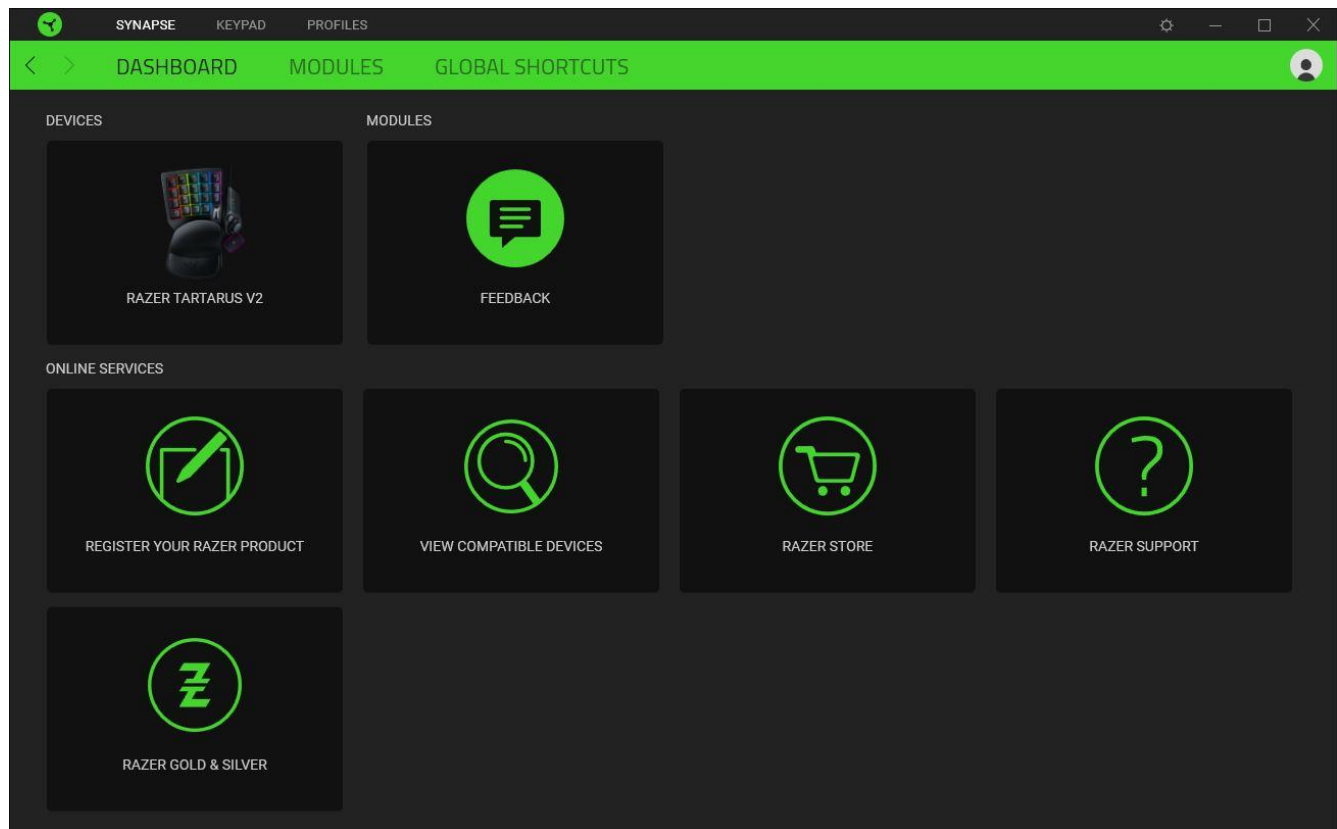

Modules

The Modules subtab displays all installed and available modules for installation.

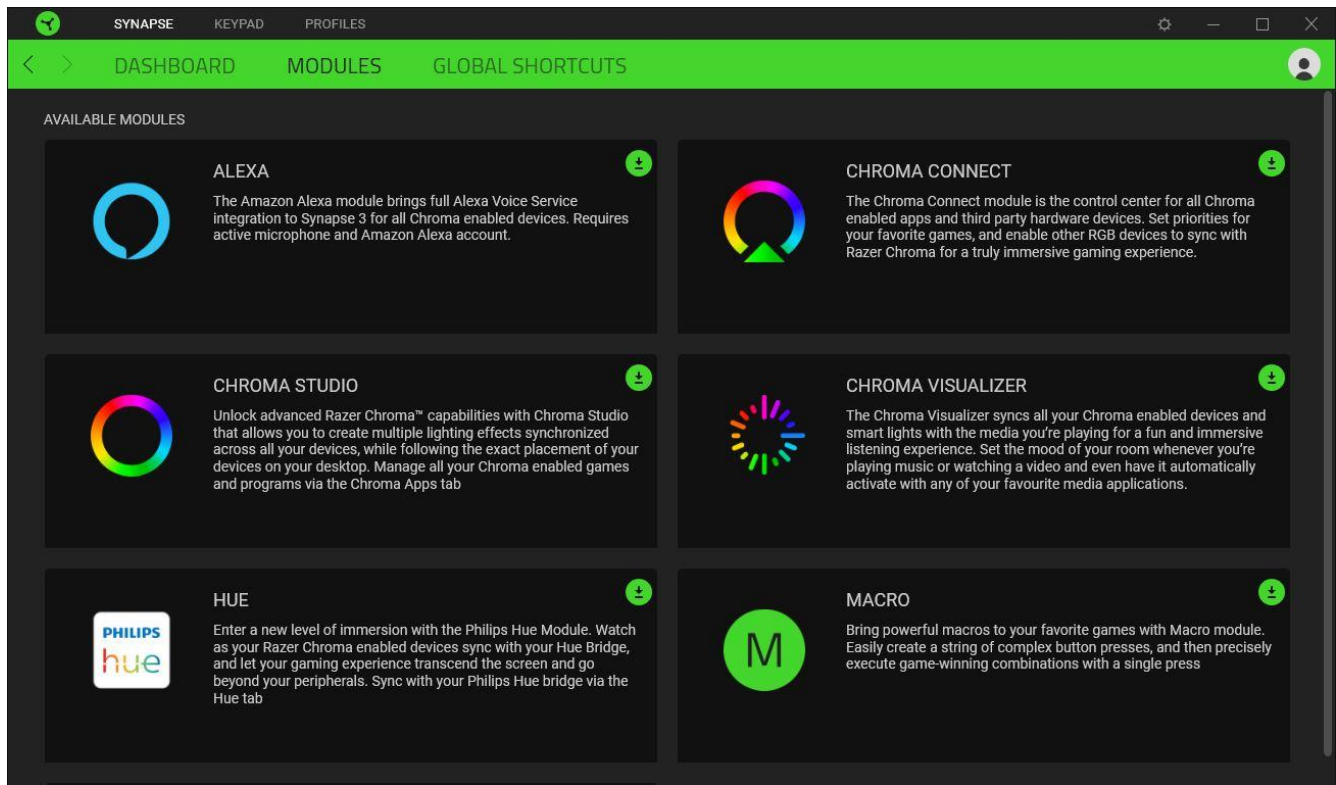

Global Shortcuts

Bind operations or Razer Synapse functions to custom key-combinations from any Razer Synapse-enabled device inputs which apply across all device profiles. [Learn more about Profiles](#)

! *Only Razer Synapse-enabled device inputs will be recognized.*

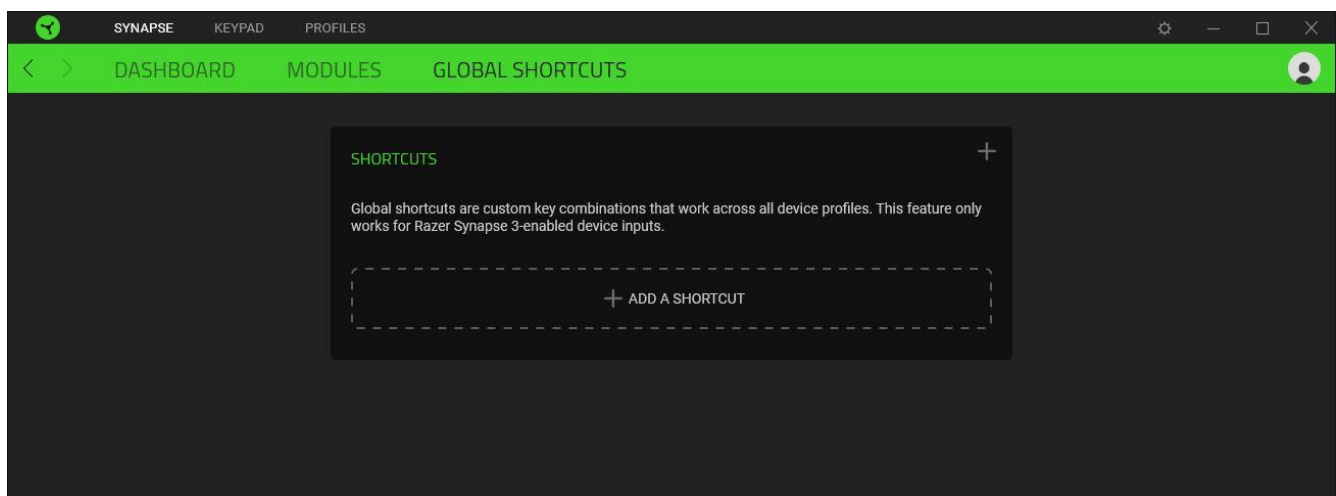

KEYPAD

The Keypad tab is the main tab for your Razer Tartarus V2. From here, you can change various settings such as each keymap's preferred key assignments, and even your device's lighting. Changes made under this tab are automatically saved to your system and cloud storage.

Customize

The Customize subtab is for modifying the key assignments for each keymap you have on your device.

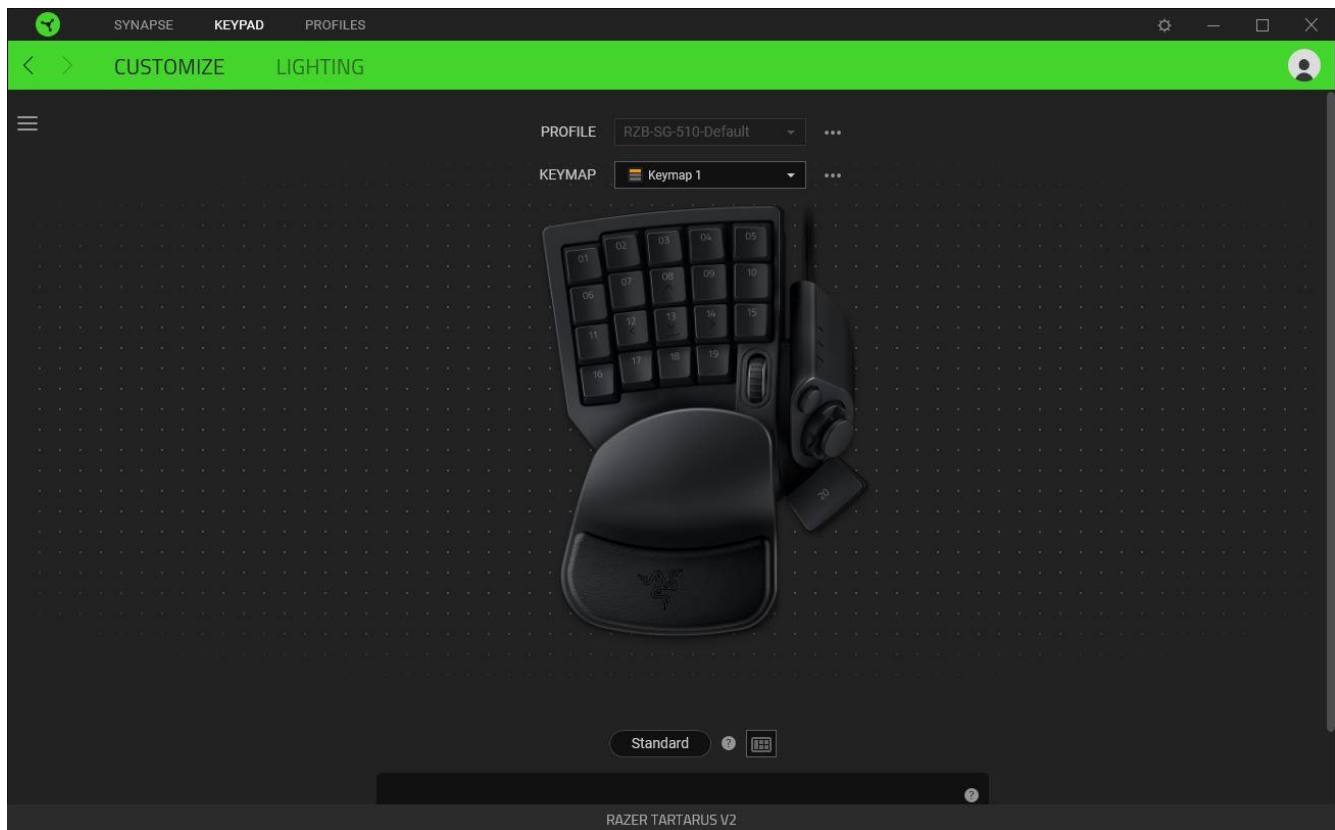

Profile

Profile is a data storage for keeping all your Razer peripheral's settings. By default, the profile name is based on your system's name. To add, import, rename, duplicate, export, or delete a profile, simply press the profile's corresponding Miscellaneous button (●●●).

Keymap

Keymaps are especially useful for games which require different play-styles for various character classes. With keymaps, you can have up to 8 sets of key assignments per profile.

Each keymap has an equivalent color on the Keymap Indicator to make it easier to check which keymap you are currently using. To add, rename, duplicate, or delete a keymap, simply press the keymap's corresponding Miscellaneous button (●●●).

Keyboard Properties

Allows you to open the Windows Keyboard Properties where you can modify other keyboard settings such as Repeat delay, Repeat Rate, and Cursor blink rate, or view all keyboard drivers installed in your PC.

Hypershift

Hypershift mode is a secondary set of key assignments that is activated when the Hypershift key is held down. By default, the Hypershift key is assigned to the fn key of your Razer Synapse supported keyboard however, you can also assign any key as a Hypershift key.

Toggle Console View

Toggle Console View opens or hides the sidebar (☰) including other keypad controls which you can modify such as the keypad's scroll wheel functions and directional thumb pad.

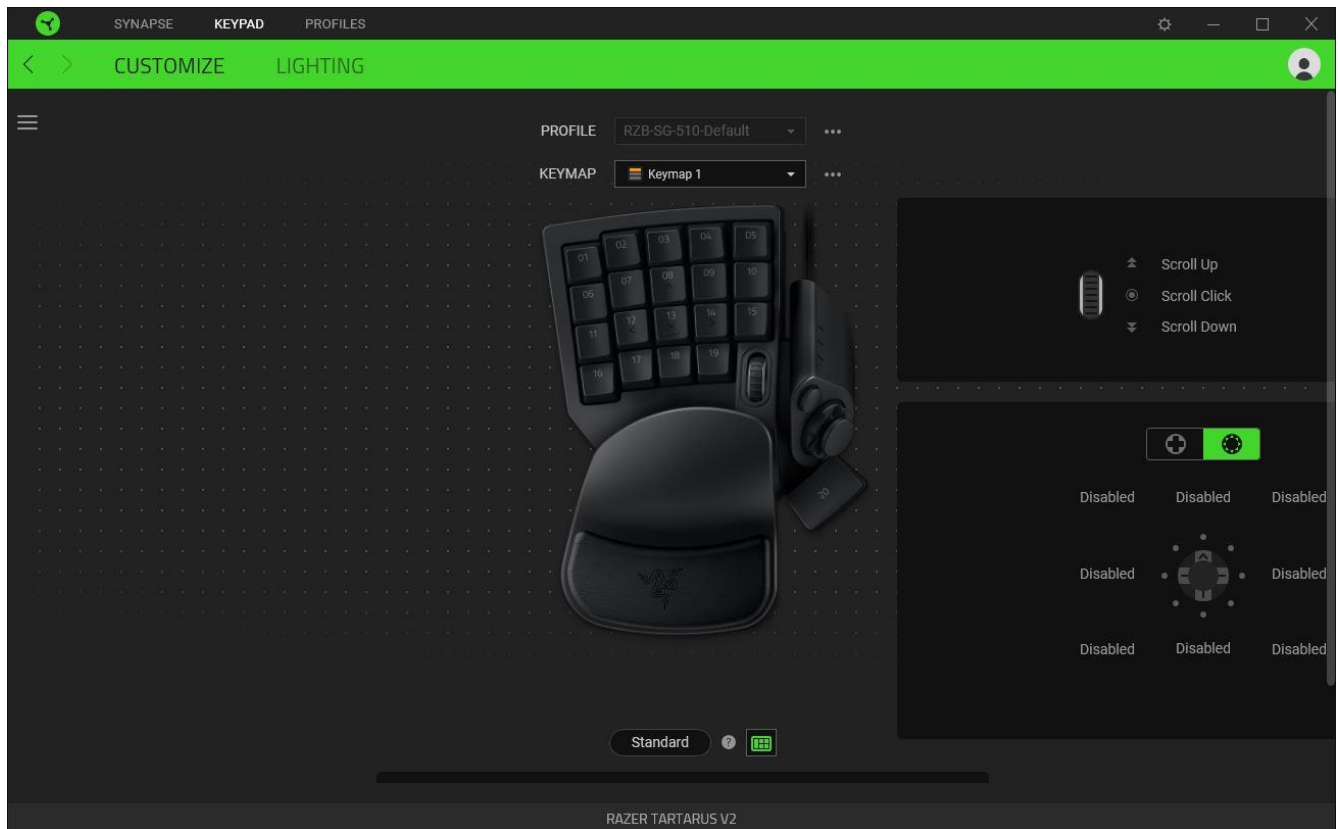

Sidebar

Clicking the Sidebar button (☰) will reveal all current key assignments for your Razer Tartarus V2.

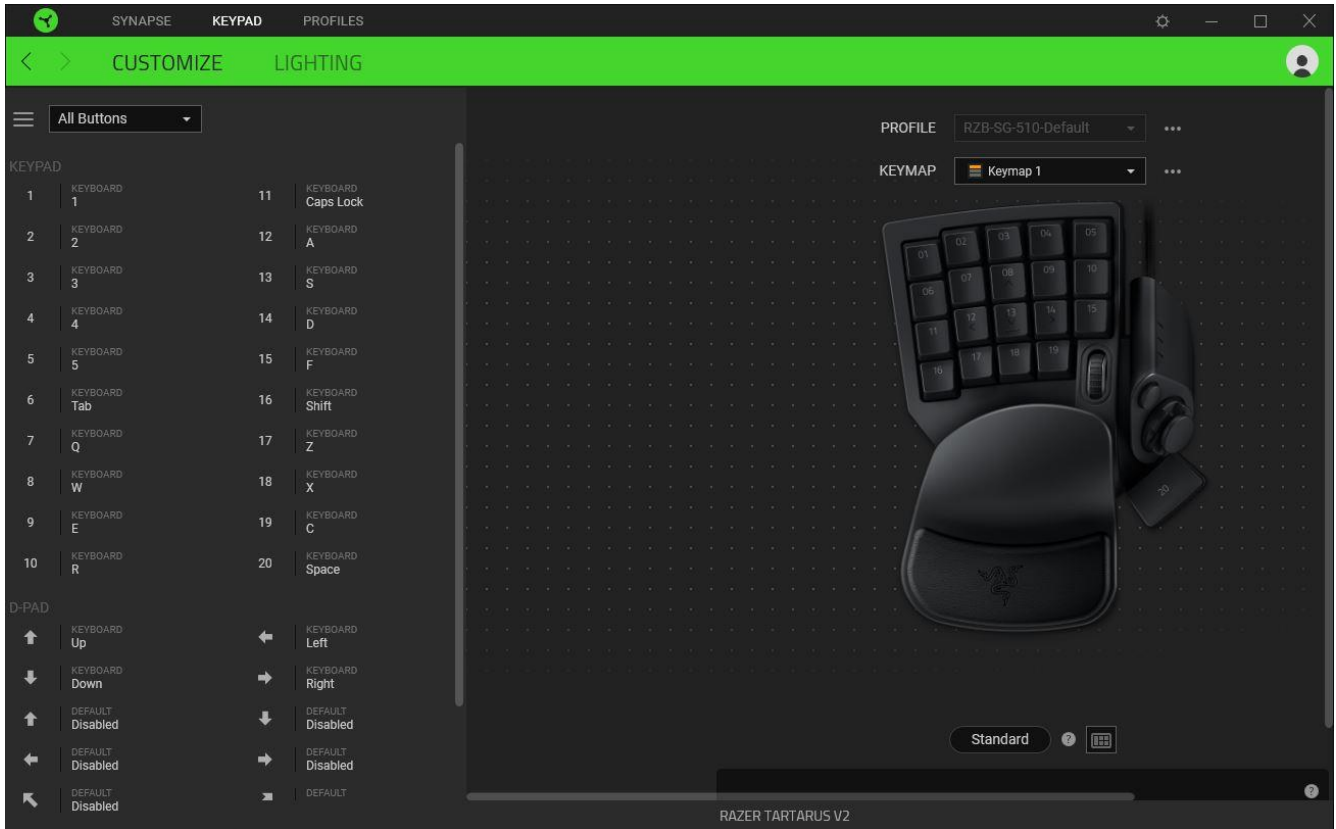

Alternatively, you can skip to a specific key assignment by selecting it on the Customize tab.

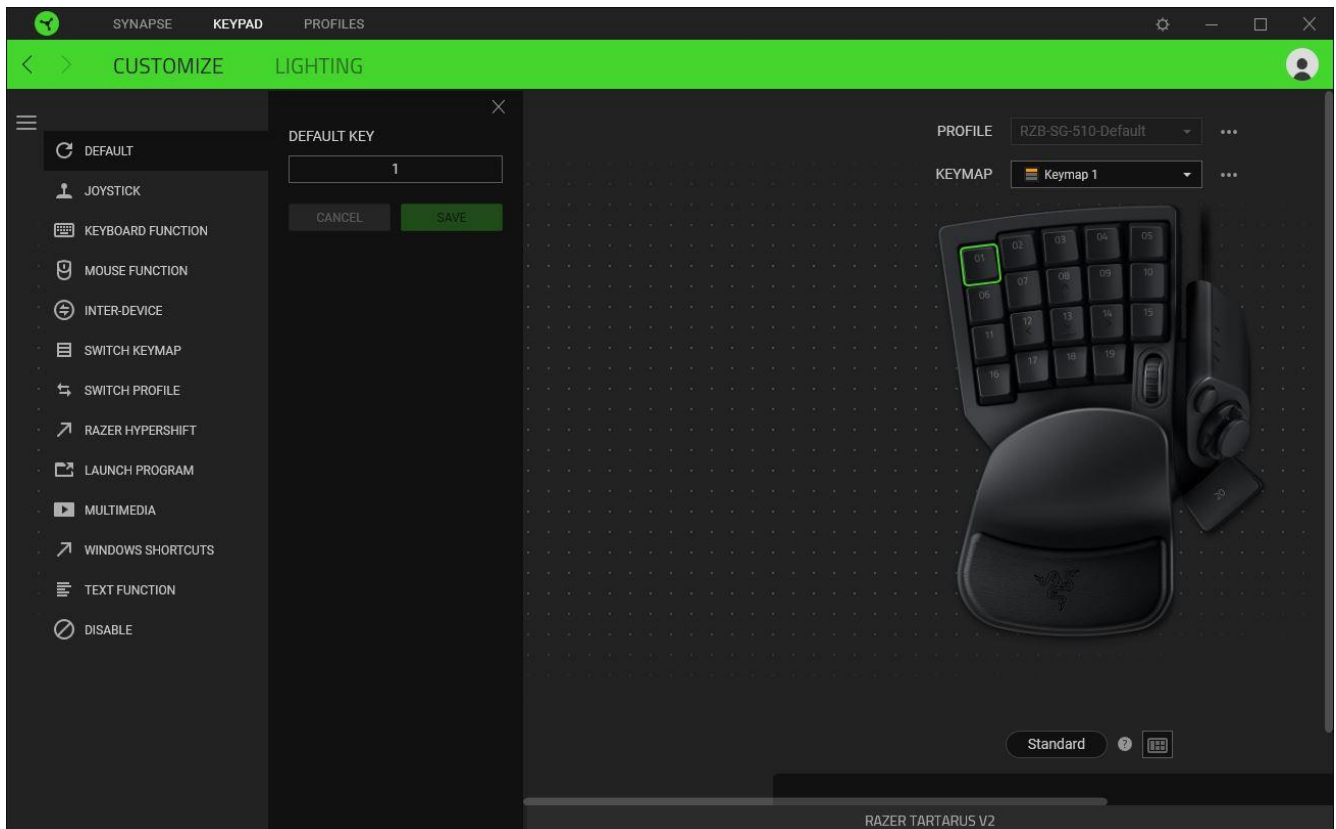

Upon selecting a key assignment, you may then change it to one of the following functions:

Default

This option enables you to return the selected key to its original setting.

Joystick

This option enables you to change the functionality of any key into a joystick button or an analog stick direction.

Keyboard Function

This option changes the key assignment into a keyboard function. You can also choose enable Turbo mode which allows you to emulate repeatedly pressing the keyboard function while the key is held down.

Mouse Function

This option allows you to change any key into a mouse function. You can also choose to enable Turbo mode in some of the mouse functions to control how many times the function will be pressed while the key is held down.

Inter-device

Inter-device allows you to change the functionality of other Razer Synapse-enabled devices. Some of these functionalities are device-specific such as using your Razer gaming keyboard to change the Sensitivity Stage of your Razer gaming mouse.

Switch Keymap

Switch Keymap allows you to swap key assignments with a press of a key. The keymap indicator will automatically change color as you switch between keymaps.

Switch Profile

Switch Profile enables you to quickly change profiles and load a new set of key assignments. An on-screen notification will appear whenever you switch profiles.

Razer Hypershift

Setting the key to Razer Hypershift will allow you to activate Hypershift mode as long as the key is held down.

Launch Program

Launch Program enables you to open an app or a website using the assigned key. When you select Launch Program, two choices will appear which requires you to search for a specific app you want to open, or write the address of the website you want to visit.

Multimedia

This option allows you to assign multimedia controls to your Razer device.

Windows Shortcuts

This option allows you to assign your preferred key into a Windows Operating System shortcut command. For more information, please visit: support.microsoft.com/kb/126449

Text Function

Text Function enables you to type a prewritten text with a touch of a key. Simply write your desired text on the given field and your text will be typed whenever the assigned key is pressed. This function has full Unicode support and you can also insert special symbols from character maps.

Disable

This option renders the assigned key unusable. Use Disable if you do not want to use the selected key or if it interferes with your gaming.

Lighting

The Lighting subtab enables you to modify your Razer device's light settings.

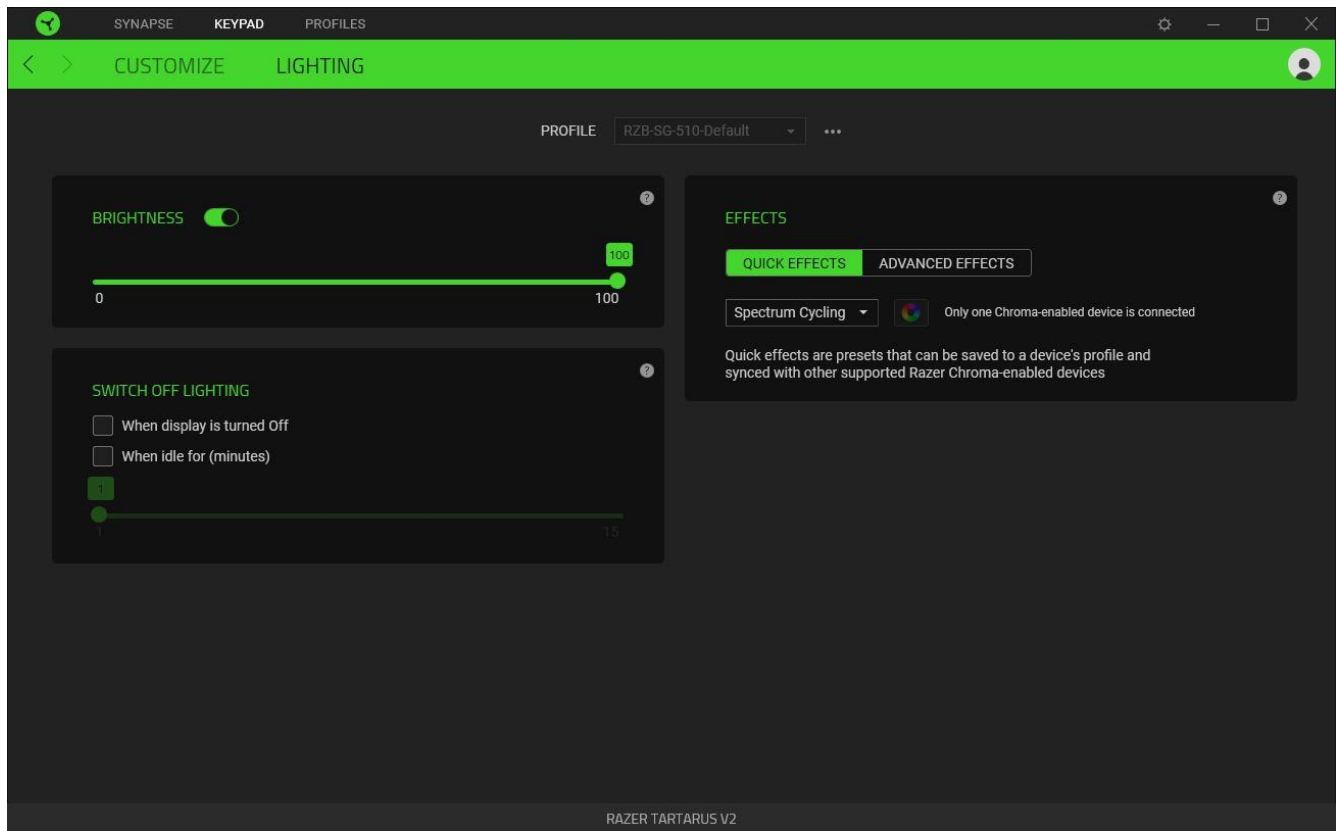

Brightness

You can turn off your Razer device's lighting by toggling the Brightness option or increase/decrease the luminance using the slider.

Switch Off Lighting









This is a power saving tool which allows you to disable your device's lighting in response to your system's display turning off and/or automatically power down when your Razer Tartarus V2 has been idle for a set amount of time.

Effects

A number of quick effects can be selected and applied to your device's lighting, as listed here:

 *LED indicators are not customizable.*

	Name	Description	How to set up
	Audio meter	The LEDs will light up according to the audio level with a default spectrum of colors	Select a Color Boost level

	Breathing	The lighting will fade in and out of the selected color(s)	Select up to 2 colors or randomize colors
	Fire	The LEDs will light up in warm colors to mimic the motion of flames	No further customization required
	Reactive	The pressed scroll wheel or key will light up and fade off after a specified period of time	Select a color and a duration
	Ripple	The lighting will ripple away from the pressed scroll wheel or key	Select a color
	Spectrum cycling	The lighting will cycle between 16.8 million colors indefinitely	No further customization required
	Starlight	Each LED will have a chance of fading in and out at a random time and duration	Select up to 2 colors or randomize colors and select a duration
	Static	The LEDs will remain lit in the selected color	Select a color
	Wave	The lighting will scroll in the direction selected	Select either left-to-right or right-to-left wave direction

If you have other supported Razer Chroma-enabled devices, you can synchronize their quick effects with your Razer device by clicking the Chroma Sync button ().

 *Only devices that support the selected lighting effect will synchronize.*

Advanced Effects

The Advanced Effects option allows you to choose a Chroma Effect you want to use on your Razer Chroma-enabled peripheral. To start making your own Chroma Effect, simply press the Chroma Studio button ().

 *The Chroma Studio module is required to use this function.*



PROFILES TAB

The Profiles tab is a convenient way of managing all your profiles and linking them to your games and applications.

Devices

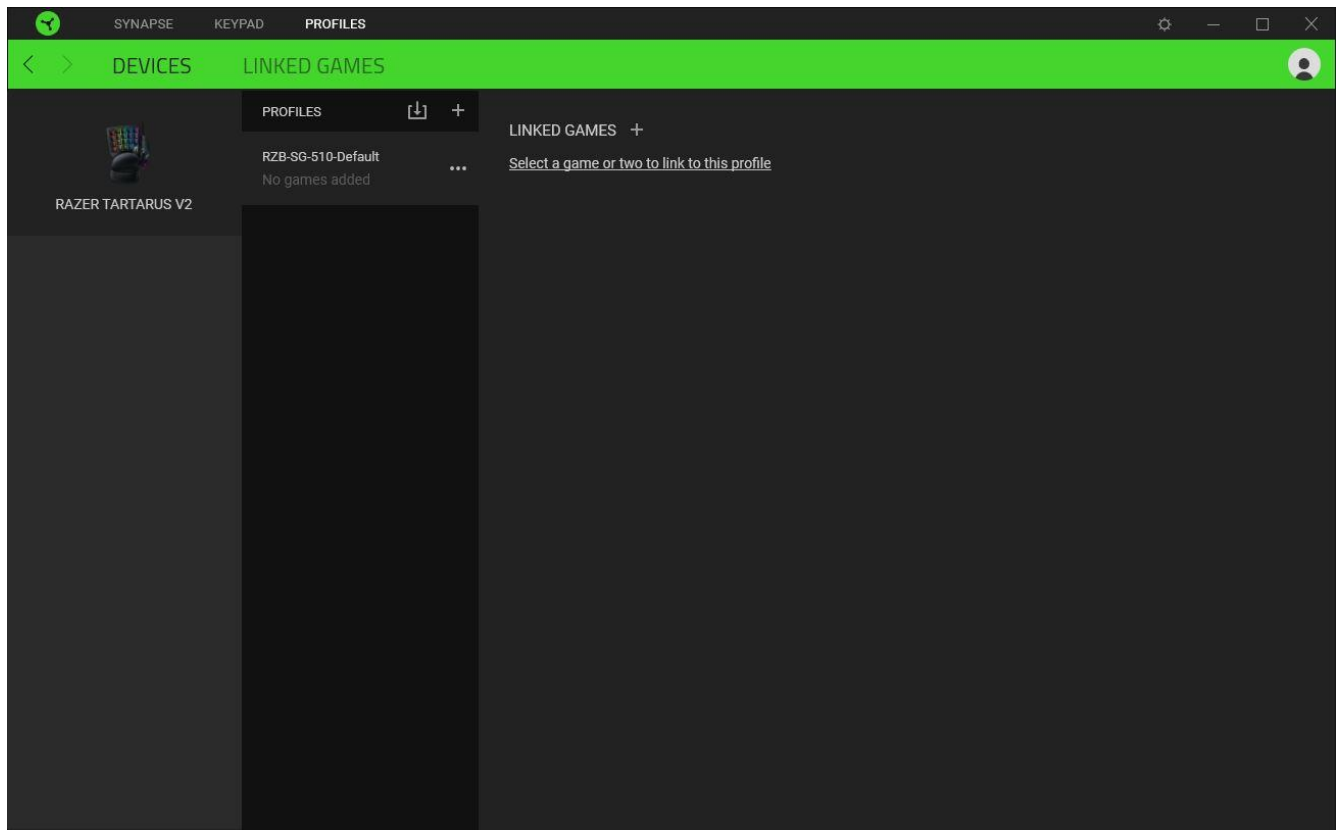
View which Razer device is using a specific profile using the Devices subtab.



You can import Profiles from your computer or from the cloud through the import button () or create new profiles within the selected device using the add button (). To rename, duplicate, export, or delete a profile, simply press the Miscellaneous button (). Each profile can be set to automatically activate when you run an application using the Linked Games option.

Linked Games

The Linked Games subtab gives you the flexibility to add games, view peripherals that are linked to games, or search for added games. You can also sort games based on alphabetical order, last played, or most played. Added games will still be listed here even if it is not linked to a Razer device.

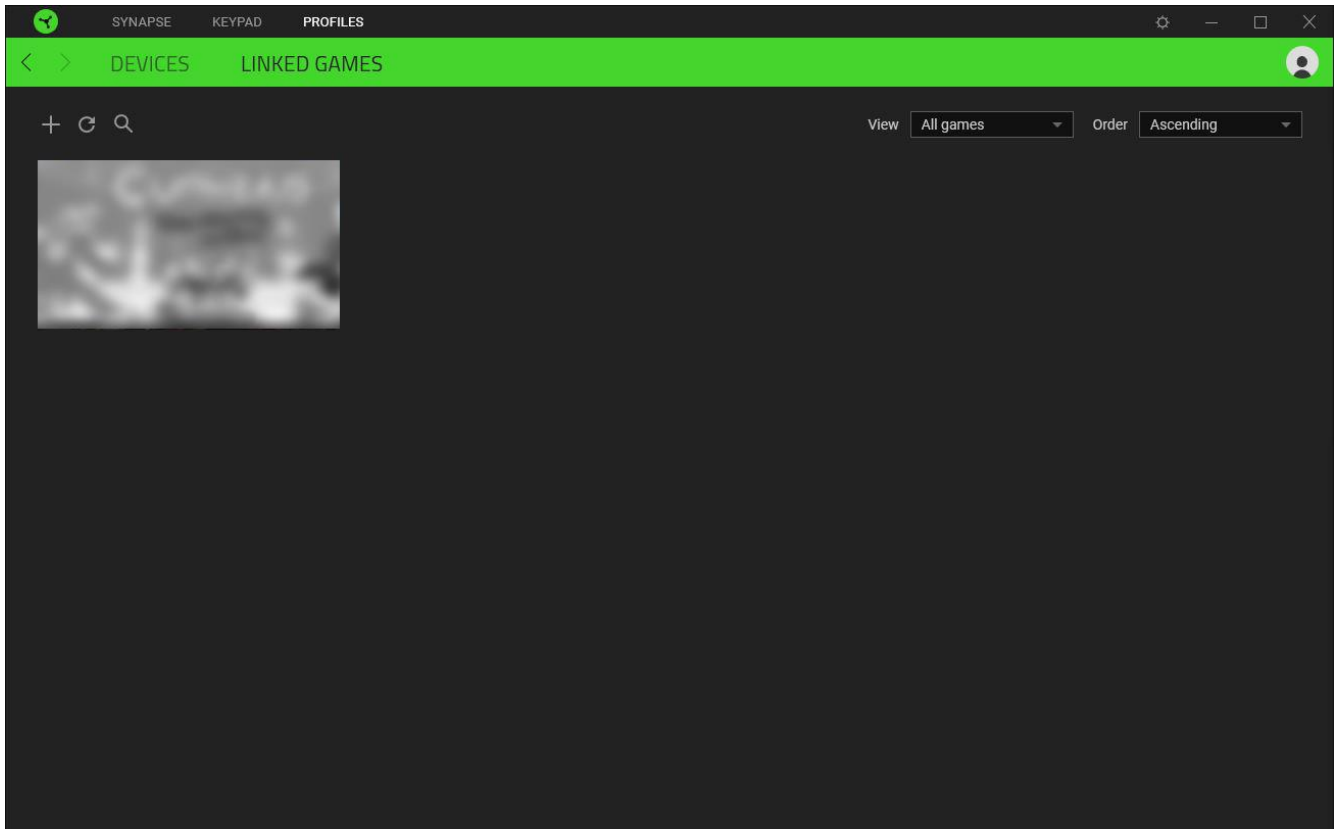

To link games to connected Razer devices, simply click on a game from the list, and then click **Select a device and its profile to launch automatically during gameplay** link to select the Razer device it will link with. Once linked, you may click on the Miscellaneous button (●●●) of the corresponding device to select a specific profile.

SETTINGS WINDOW

The Settings window, accessible by clicking the (⚙️) button on Razer Synapse, enables you to configure the startup behavior and display language of Razer Synapse, view the master guides of each connected Razer device, or perform factory reset on any connected Razer device.

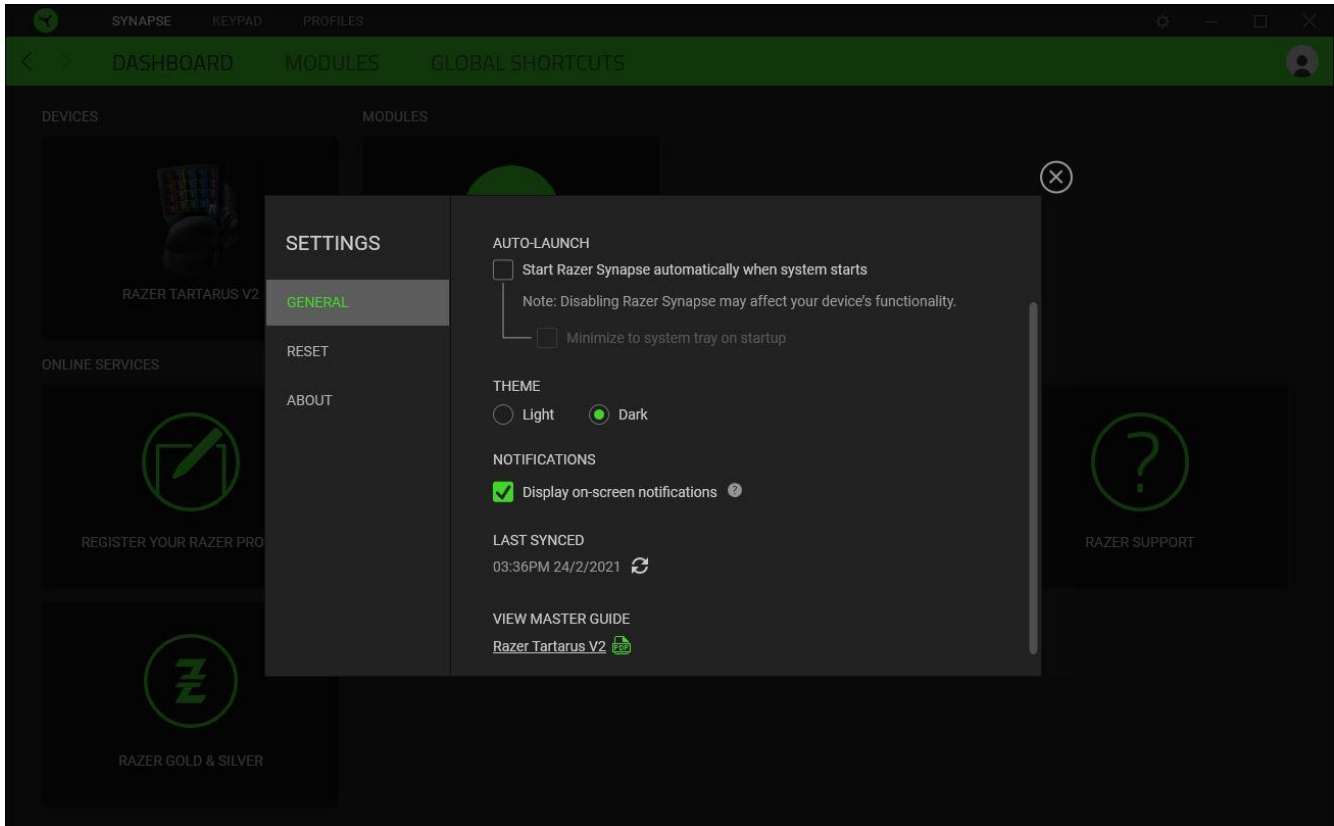

General tab

The default tab of the Settings window. The General tab enables you to change the software's display language, start-up behavior, and display theme. You may also manually sync your profiles to the cloud (↻) or view the master guide of all connected Razer devices and installed modules.

Reset tab

The Reset tab allows you to perform a factory reset on any connected Razer device and/or reset Razer Synapse tutorials to acquaint yourself again with Razer Synapse's new features on its next launch.

! *By resetting a Razer device, all profiles on the selected device and its on-board memory (if present) will be erased.*

About tab

The About tab displays brief software information and copyright statement and provides relevant links for its terms of use. You may also use this tab to check for software updates, or as a quick access to Razer's social communities.

7. SAFETY AND MAINTENANCE

SAFETY GUIDELINES

In order to achieve maximum safety while using your Razer Tartarus V2, we suggest that you adopt the following guidelines:

Should you have trouble operating the device properly and troubleshooting does not work, unplug the device and contact the Razer hotline or go to support.razer.com for support.

Do not take apart the device (doing so will void your warranty) and do not attempt to operate it under abnormal current loads.

Keep the device away from liquid, humidity or moisture. Operate the device only within the specific temperature range of 0°C (32°F) to 40°C (104°F). Should the temperature exceed this range, unplug and/or switch off the device in order to let the temperature stabilize to an optimal level.

COMFORT

Research has shown that long periods of repetitive motion, improper positioning of your computer peripherals, incorrect body position, and poor habits may be associated with physical discomfort and injury to nerves, tendons, and muscles. Below are some guidelines to avoid injury and ensure optimum comfort while using your Razer Tartarus V2.

1. Position your keypad and monitor directly in front of you with your mouse next to it. Place your elbows next to your side, not too far away and your keyboard within easy reach.
2. Adjust the height of your chair and table so that the keypad and mouse are at or below elbow height.
3. Keep your feet well supported, posture straight and your shoulders relaxed.
4. During gameplay, relax your wrist and keep it straight. If you do the same tasks with your hands repeatedly, try not to bend, extend or twist your hands for long periods.
5. Do not rest your wrists on hard surfaces for long periods.
6. Customize the keys on your keypad to suit your style of gaming in order to minimize repetitive or awkward motions while gaming.
7. Do not sit in the same position all day. Get up, step away from your desk and do exercises to stretch your arms, shoulders, neck and legs.

If you should experience any physical discomfort while using your keypad, such as pain, numbness, or tingling in your hands, wrists, elbows, shoulders, neck or back, please consult a qualified medical doctor immediately.

MAINTENANCE AND USE

The Razer Tartarus V2 requires minimum maintenance to keep it in optimum condition. Once a month we recommend you unplug the device from the computer and clean it using a soft cloth or cotton swab to prevent dirt buildup. Do not use soap or harsh cleaning agents.

8. LEGALESE

COPYRIGHT AND INTELLECTUAL PROPERTY INFORMATION

©2018 Razer Inc. All rights reserved. Razer, the triple-headed snake logo, Razer logo, “For Gamers. By Gamers.”, and “Powered by Razer Chroma” logo are trademarks or registered trademarks of Razer Inc. and/or affiliated companies in the United States or other countries. All other trademarks are the property of their respective owners.

Windows and the Windows logo are trademarks of the Microsoft group of companies.

Razer Inc. (“Razer”) may have copyright, trademarks, trade secrets, patents, patent applications, or other intellectual property rights (whether registered or unregistered) concerning the product in this guide. Furnishing of this guide does not give you a license to any such copyright, trademark, patent or other intellectual property right. The Razer Tartarus V2 (the “Product”) may differ from pictures whether on packaging or otherwise. Razer assumes no responsibility for such differences or for any errors that may appear. Information contained herein is subject to change without notice.

LIMITED PRODUCT WARRANTY

For the latest and current terms of the Limited Product Warranty, please visit razer.com/warranty.

LIMITATION OF LIABILITY

Razer shall in no event be liable for any lost profits, loss of information or data, special, incidental, indirect, punitive or consequential or incidental damages, arising in any way out of distribution of, sale of, resale of, use of, or inability to use the Product. In no event shall Razer’s liability exceed the retail purchase price of the Product.

GENERAL

These terms shall be governed by and construed under the laws of the jurisdiction in which the Product was purchased. If any term herein is held to be invalid or unenforceable, then such term (in so far as it is invalid or unenforceable) shall be given no effect and deemed to be excluded without invalidating any of the remaining terms. Razer reserves the right to amend any term at any time without notice.