



DW60M6043 Series
DW60M5043 Series
DW60M5042 Series

Dishwasher user manual

imagine the possibilities

Thank you for purchasing this Samsung product.



SAMSUNG

Safety instructions

Congratulations on your new Samsung dishwasher. This manual contains important information on the installation, use and care of your appliance. Please take time to read this manual to take full advantage of your dishwasher's many benefits and features.

WHAT YOU NEED TO KNOW ABOUT SAFETY INSTRUCTIONS











Please read this manual thoroughly to ensure that you know how to safely and efficiently operate the extensive features and functions of your new appliance and retain it at a safe place near the appliance for your future reference. Use this appliance only for its intended purpose as described in this user manual.

Warning and important safety instructions in this manual do not cover all possible conditions and situations that may occur. It is your responsibility to use common sense, caution, and care when installing, maintaining, and operating your dishwasher.

Because the following operating instructions cover various models, the characteristics of your dishwasher may differ slightly from those described in this manual and not all warning signs may be applicable. If you have any questions or concerns, contact your nearest service center or find help and information online at www.samsung.com.

IMPORTANT SAFETY SYMBOLS AND PRECAUTIONS

Important safety symbols

	Hazards or unsafe practices that may result in severe personal injury and/or property damage.
	Hazards or unsafe practices that may result in personal injury and/or property damage.
	To reduce the risk of fire, explosion, electric shock, or personal injury when using your dishwasher, follow these basic safety precautions:
	Do NOT attempt.
	Do NOT disassemble.
	Do NOT touch.
	Follow directions explicitly.
	Unplug the power plug from the wall socket.
	Make sure the appliance is grounded to prevent electric shock.
	Call the service centre for help.
	Note

These warning symbols are here to prevent injury to you and others.

Please follow them explicitly.

Keep these instructions in a safe place and ensure that new users are familiar with the content. Pass them on to any future owner.

 To reduce the risk of fire, electric shock, or injury to persons when using your appliance, follow basic precautions, including the following:

1. This appliance is not to be used by persons (including children) with reduced physical, sensory or mental capabilities, or lack of experience and knowledge, unless they have been given supervision or instruction concerning use of the appliance by a person responsible for their safety.
2. **For use in Europe:** This appliance can be used by children aged from 8 years and above and persons with reduced physical, sensory or mental capabilities or lack of experience and knowledge if they have been given supervision or instruction concerning use of the appliance in a safe way and understand the hazards involved. Children shall not play with the appliance. Cleaning and user maintenance shall not be made by children without supervision.
3. Children should be supervised to ensure that they do not play with the appliance.
4. If the supply cord is damaged, it must be replaced by the manufacturer, its service agent or similarly qualified persons in order to avoid a hazard.
5. The new hose-sets supplied with the appliance are to be used and that old hose-sets should not be reused.
6. For appliances with ventilation openings in the base, that a carpet must not obstruct the openings.
7. **For use in Europe:** Children of less than 3 years should be kept away unless continuously supervised.

Safety instructions

- 8. CAUTION:** In order to avoid a hazard due to inadvertent resetting of the thermal cut-out, this appliance must not be supplied through an external switching device, such as a timer, or connected to a circuit that is regularly switched on and off by the utility.
- 9.** This appliance is intended to be used in household and similar applications such as:
 - staff kitchen areas in shops, offices and other working environments;
 - farm houses;
 - by clients in hotels, motels and other residential type environments;
 - bed and breakfast type environments.
- 10.** The door should not be left in the open position since this could present a tripping hazard.
- 11. WARNING:** Knives and other utensils with sharp points must be loaded in the basket with their points down or placed in a horizontal position.
- 12. WARNING:** Some dishwasher detergents are strongly alkaline. They can be extremely dangerous if swallowed. Avoid contact with the skin and eyes and keep children away from the dishwasher when the door is open. Check that the detergent receptacle is empty after completion of the wash cycle.

INSTRUCTIONS WHEN USING YOUR DISHWASHER

 This dishwasher is not designed for commercial use. It is intended for use in domestic households and in similar working and residential environments such as:

- Shops
- Offices and showrooms

and by residents in establishments such as:

- Hostels and guest houses.

 It must only be used as a domestic appliance as specified in these user manual, for cleaning domestic crockery and cutlery.
Any other usage is not supported by the manufacturer and could be dangerous.

 The manufacturer cannot be held liable for damage resulting from incorrect or improper use or operation.

 Do not use solvents in the dishwasher. Danger of explosion.

 Do not inhale or ingest dishwasher detergent. Dishwasher detergents contain irritant or corrosive ingredients which can cause burning in the nose, mouth and throat if swallowed, or inhibit breathing. Consult a doctor immediately if detergent has been swallowed or inhaled.

 Avoid leaving the door open unnecessarily, as you could trip over it.

 Do not sit or lean on the opened door. This could cause the dishwasher to tip and be damaged, and you could get injured.

 Only use detergent and rinse aid formulated for domestic dishwashers.
Do not use washing-up liquid.

 Do not use the strong acid cleaning agent.

 Do not fill the rinse aid reservoir with powder or liquid detergent. This will cause serious damage to the reservoir.

 Inadvertently filling the salt reservoir with powder or liquid dishwasher detergent will damage the water softener. Make sure you have picked up the correct packet of dishwasher salt before filling the salt reservoir.

 Please only use special coarse grained dishwasher salt for reactivation, as other salts may contain insoluble additives which can impair the functioning of the softener.

 In an appliance with a cutlery basket (depending on model), cutlery is cleaned and dried more if placed in efficiently the basket with the handles downwards. However, to avoid the risk of injury, place knives and forks etc. with the handles upwards.

 Plastic items which cannot withstand being washed in hot water, such as disposable plastic containers, or plastic cutlery and crockery should not be cleaned in the dishwasher.
The high temperatures in the dishwasher may cause them to melt or lose shape.

 On models with Delay Start function, make sure that the dispenser is dry before adding detergent. Wipe dry if necessary. Detergent will clog if poured into a damp dispenser and may not be thoroughly dispersed.

 Knives and other utensils with sharp points must be loaded in the basket with their points down or placed in a horizontal position.

Safety instructions

INSTRUCTIONS FOR PROTECTING YOUR CHILDREN



This appliance is not a toy! To avoid the risk of injury, keep children well away and do not allow them to play in or around the dishwasher or to use the controls. They will not understand the potential dangers posed by it. They should be supervised whenever you are working in the kitchen.

There is also a danger that children playing might shut themselves in the dishwasher.



This appliance can be used by children aged from 8 years and above and persons with reduced physical, sensory or mental capabilities or lack of experience and knowledge if they have been given supervision or instruction concerning use of the appliance in a safe way and understand the hazards involved. Children shall not play with the appliance.

Cleaning and user maintenance shall not be made by children without supervision.



Older children may only use the dishwasher when its operation has been clearly explained to them and they are able to use it safely, recognising the dangers of misuse.



KEEP CHILDREN AWAY FROM DETERGENTS! Dishwasher detergents contain irritant and corrosive ingredients which can cause burning in the mouth, nose and throat if swallowed, or inhibit breathing. Keep children away from the dishwasher when the door is open.

There could still be detergent residues in the cabinet.

Consult a doctor immediately if your child has swallowed or inhaled detergent.

INSTRUCTIONS FOR INSTALLING YOUR DISHWASHER



Before setting up the appliance, check it for any externally visible damage. Under no circumstances should you use a damaged appliance. A damaged appliance could be dangerous.



The dishwasher must only be plugged into the electricity supply via a suitable switched socket. The electrical socket must be easily accessible after the dishwasher is installed so that it can be disconnected from the electricity supply at any time. (Refer to the “Parts and features” section on page 10.)



There must be no electrical sockets behind the dishwasher. Danger of overheating and fire risk if the dishwasher were to be pushed up against a plug.



The dishwasher must not be installed under a hob. The high radiant temperatures which are sometimes generated by a hob could damage the dishwasher. For the same reason it should not be installed next to open fires or other appliances which give off heat, such as heaters etc.



Do not connect the dishwasher to the mains supply until it has been fully installed and any adjustment has been made to the door springs.



Before connecting the appliance, check that the connection data on the data plate (voltage and connected load) match the mains electricity supply. If in any doubt, consult a qualified electrician.



The electrical safety of this appliance can only be guaranteed when continuity is complete between it and an effective grounding system. It is most important that this basic safety requirement is present and regularly tested and where there is any doubt the electrical system in the house should be checked by a qualified electrician.

The manufacturer cannot be held liable for the consequences of an inadequate grounding system (e.g. electric shock).



Do not connect the appliance to the mains electricity supply by a multi-socket unit or an extension lead. These do not guarantee the required safety of the appliance (e.g. danger of overheating).



This appliance may only be installed in mobile installations such as ships if a risk assessment of the installation has been carried out by a suitably qualified engineer.



The plastic housing of the water connection contains an electrical component. The housing must not be submerged in water.



There are electrical wires in the hose of Aqua-Stop. Never cut the water inlet hose, even if it is too long.



Installation, maintenance and repairs may only be carried out by a suitably qualified and competent person in strict accordance with current national and local safety regulations. Repairs and other work by unqualified persons can be dangerous. The manufacturer cannot be held liable for unauthorised work.



The integrated waterproof system offers protection from water damage, provided the following conditions are met:

- The dishwasher is correctly installed and plumbed in.
- The dishwasher is properly maintained and parts are replaced where it can be seen that this is necessary.
- The stopcock has been turned off when the appliance is not used for a longer period of time (e.g. during holidays).
- The waterproof system will work even if the appliance is switched off. However, the appliance must remain connected to the electricity supply.



A damaged appliance can be dangerous. If the dishwasher gets damaged, switch it off at the mains and call your dealer or the service department.



Unauthorised repairs could result in unforeseen dangers for the user, for which the manufacturer cannot accept liability. Repairs should only be undertaken by an approved service technician.



Faulty components must only be replaced by original spare parts. Only when these parts are fitted can the safety of the appliance can be guaranteed.



Always disconnect the dishwasher from the electrical supply for maintenance work (switch off at the wall socket and remove the plug).



If the connection cable is damaged it must be replaced with a special cable, available from the manufacturer. For safety reasons, this must only be fitted by the service department or an authorised service technician.



In countries where there are areas which may be subject to infestation by cockroaches or other vermin, pay particular attention to keeping the appliance and its surroundings in a clean condition at all times. Any damage which may be caused by cockroaches or other vermin will not be covered by the guarantee.



In the event of a fault or for cleaning purposes, the appliance is only completely isolated from the electricity supply when:

- it is switched off at the wall socket and the plug is withdrawn, or
- it is switched off at the mains, or
- the mains fuse is disconnected, or
- the screw-out fuse is removed (in countries where this is applicable).



Do not make any alterations to the appliance, unless authorised to do so by the manufacturer.

Safety instructions



Never open the casing/housing of the appliance.

Tempering with electrical connections or components and mechanical parts is highly dangerous and can cause operational faults or electric shock.



While the appliance is under guarantee, repairs should only be undertaken by a service technician authorised by the manufacturer. Otherwise the guarantee will be invalidated.



When installing the product, make sure there is space at the top, left, right and back of the product to ensure proper ventilation.

If there is insufficient space between the product and the sink, it may damage the sink or allow mold to grow.



Make sure that your dishwasher's hardness level setting is correct as your area. (Refer to the "Water softener" section on page 13.)



Before using the dishwasher, remove the silicon taping from the rollers of the lower basket.

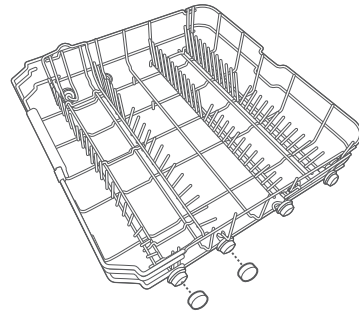

Correct Disposal of This Product (Waste Electrical & Electronic Equipment)

(Applicable in countries with separate collection systems)

This marking on the product, accessories or literature indicates that the product and its electronic accessories (e. g. charger, headset, and USB cable) should not be disposed of with other household waste at the end of their working life. To prevent possible harm to the environment or the human health from uncontrolled waste disposal, please separate these items from other types of waste and recycle them responsibly to promote the sustainable reuse of material resources.

For more information on safe disposal and recycling visit our website.

www.samsung.com/in/support or contact our Helpline numbers-

1800 40 SAMSUNG(7267864)

1800 5 SAMSUNG(7267864)

Contents

PARTS AND FEATURES	10	10	Dishwasher features
		11	Control panel
		12	Displays
USING THE DETERGENT AND WATER SOFTENER	13	13	Water softener
		14	Loading the salt into the softener
		15	Using detergent
		16	Using rinse aid
		18	How to use the multi tab option
		19	Setting mode
LOADING THE DISHWASHER RACKS	21	21	Loading the upper basket
		23	Loading the lower basket
		23	Folding spikes of lower basket (applicable models only)
		24	Cutlery(silverware) tray
		25	For washing in the dishwasher the following cutlery/dishes
WASHING PROGRAMMES	26	26	Turning on the appliance
		26	Change the programme
		27	At the end of the wash cycle
		28	Wash cycle table
CLEANING AND CARE	30	30	Cleaning the filters
		31	Cleaning the spray arms
		31	Cleaning the door
		31	Caring for the dishwasher
		31	Protect against freezing
		32	How to maintain your dishwasher
SETTING UP YOUR DISHWASHER	33	33	Water supply and drain
		35	Connection of drain hoses
		35	Position the appliance
		35	Start of dishwasher
TROUBLESHOOTING	36	36	Before calling for service
		38	Information codes
APPENDIX	39	39	Specifications
		39	Product dimension

Parts and features

DISHWASHER FEATURES

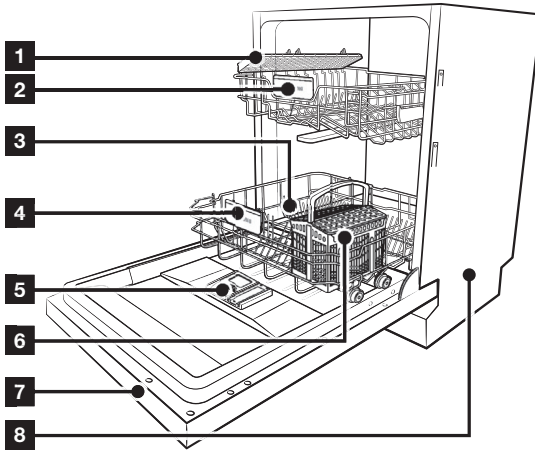

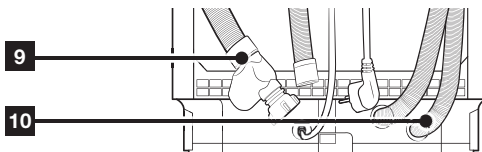

1	Knife rack
2	Upper rack
3	Salt storage
4	Lower rack
5	Dispenser
6	Cutlery basket
7	Door
8	Base
9	Inlet hose
10	Drain hose
11	Inlet valve

< DW60M6043FS >

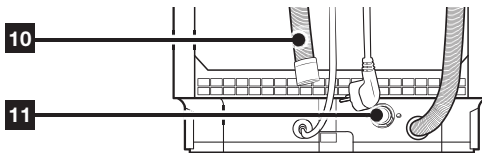

< DW60M5043FS/DW60M5042F* >



 Depending on the models, actual parts may look differ from the figures.

CONTROL PANEL

DW60M6043F*/DW60M5043F*/DW60M5042F*

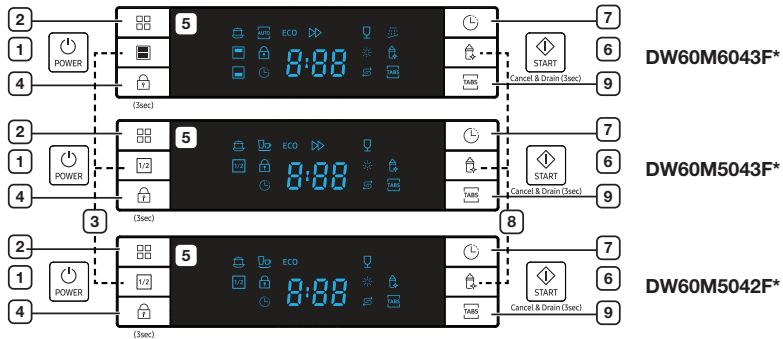

1	POWER	Press to turn the dishwasher on or off.
2	Program	Press to select a desired wash cycle.
3	Half load	For small amount of loading items, use either the upper or lower basket only to save energy. Press the Half load button to select the upper or lower basket. (DW60M6043) For small amount of loading items, press the Half load button to save energy. (DW60M5043/DW60M5042 models)
4	Control lock	Control lock allows you to lock the buttons on the control panel so children cannot accidentally start the dishwasher by pressing the buttons on the panel. To lock and unlock the buttons on the control panel, hold down the Control lock button for three (3) seconds.
5	Display window	Running indicator, delay time, information codes and etc.
6	START	Press START to start operation. Make sure the door is closed. *Reset: To cancel a currently running cycle and drain the dishwasher, press and hold the START button for three (3) seconds. Once the dishwasher is reset, select a cycle and option, and then press START to restart the dishwasher.
7	Delay start	You can delay the cycle starting up to 24 hours.
8	Hygiene	Push the Hygiene button for the best possible hygiene in your dishwasher.
9	Multi tab	To select Multi tab option which allows the replacement of salt and rinse aid with a Multi detergent tablets.

- When the door is open only the **POWER** button will operate.
- You can select options (**Multi tab**, **Delay start** and/or **Half load**) before starting a cycle.

IMPORTANT: To get the best performance from your dishwasher, read all the operating instructions before using it for the first time.

Parts and features

DISPLAYS

DW60M6043F*/DW60M5043F*/DW60M5042F*

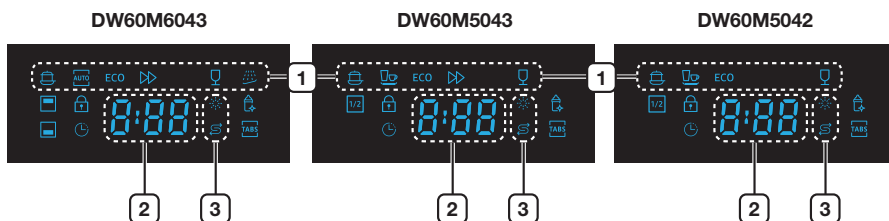

1	Program icons	Press the Program button to select each program.
	Intensive70	Select this cycle for heavily soiled items.
	Auto wash	This cycle detects the level of soil and automatically initiates the optimal cycle, which is appropriate for all levels of soiled items. (DW60M6043F*)
	Normal	For normally soiled loads, such as pots, plates, glasses, and lightly soiled pans. (DW60M5043F*/DW60M5042F*)
ECO	ECO	This cycle reduces power and water consumption, which is appropriate for normally soiled items.
	Express	Normally soiled daily using items, with short cycle time. (DW60M6043F*/DW60M5043F*)
	Delicate	Select this cycle for lightly soiled, fragile items such as glasses.
	Pre wash	Cold water rinse for removing dirt before running another program. (DW60M6043F*)
2	Display	Display the remaining time, information code, or delay time.
3	Refill indicators	If Rinse or Salt Refill indicator is lit, it means rinse or salt is needed to refill.
	Rinse refill indicator	Lights up if the dishwasher runs out of rinse aid. To refill the rinse reservoir, refer to the "Filling the rinse aid reservoir" section on page 16 .
	Salt refill indicator	Lights up when the salt storage runs out of salt. To refill the salt storage, refer to the "Loading the salt into the softener" section on page 14 .
	Delay start indicator	Lights up if " Delay start " is activated.

Using the detergent and water softener

WATER SOFTENER

The water softener is designed to remove minerals and salts from the water, which would have a detrimental or adverse effect on the operation of the appliance. We recommend using soft water for better results. Hard water contains impurities that can reduce the washing performance. You will need to soften the water if the supplied water is harder than 100 mg/l (6 °d - German scale).

- To soften the water, you need dishwasher-specific salt and configuration of the water hardness level according to your area. For more information about the water hardness level in your area, contact your local water department.
- If the hardness level of the supplied water supply is unsteady, set the dishwasher to the highest measurement. For example, if the water hardness reading ranges from 670 mg/l to 900 mg/l, set the dishwasher to 900 mg/l.
- The dishwasher's default water hardness level is 3 (2.1-3.0 mmol/l). If this setting matches the water hardness level in your area, you do not need to change it.

ADJUSTING SALT CONSUMPTION

To set the salt consumption, refer to the "Setting mode" section on page 19.

* Default setting: "H3"

WATER HARDNESS					selector position	salt consumption
° dH	° fH	° Clark	mmol/L	mg/L Ppm		
0-5	0-9	0-6	0-0.94	0-94	H1	0
6-11	10-20	7-14	1.0-2.0	100-200	H2	9
12-17	21-30	15-21	2.1-3.0	210-300	H3	12
18-22	31-40	22-28	3.1-4.0	310-400	H4	20
23-34	41-60	29-42	4.1-6.0	410-600	H5	30
35-55	61-98	43-69	6.1-9.8	610-980	H6	60

- ☑ 1 dH (German degree) = 0.178 mmol/l = 17.8 mg/l
- ☑ 1 Clark (British degree) = 0.143 mmol/l = 14.3 mg/l
- ☑ 1 fH (French degree) = 0.1 mmol/l = 10mg/l

- ☑ Contact your local water board for information on the hardness of your water supply.
- ☑ The hardness of the water varies from place to place. If hard water is used in the dishwasher, deposits may form on dishes and utensils. The appliance is equipped with a special softener that uses a salt specifically designed to eliminate lime and minerals from the water.
- ☑
 - Regeneration will be operated in dry phase with an additional 2.0-2.5 l of water being used and 4-10 minutes taken for the cycle.
 - The energy used may be increased however this should be by an insignificant amount.

[Deposits on utensils]



Using the detergent and water softener

LOADING THE SALT INTO THE SOFTENER

Always use salt intended for use with dishwasher.

The salt container is located beneath the lower rack and should be filled as follows:

ATTENTION

- Only use salt specifically designed for use in dishwashers. All other types of salt not specifically designed for use in a dishwasher, especially table salt, will damage the water softener. In case of damages caused by the use of unsuitable salt the manufacturer does not give any warranty nor is liable for any caused damages.
- Only fill with salt just before starting one of the complete washing programs. This will prevent any grains of salt or salty water, which may have been split, remaining of the bottom of the machine for any period of time, which may cause corrosion.
- After the first wash cycle the control panel light expires.

1. Remove the lower basket and then unscrew and remove the cap from the salt container.

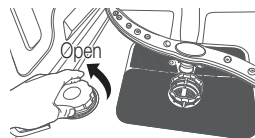

2. If you are filling the container for the first time, fill 2/3 of its volume with water (around 1 liter).
3. Place the end of the funnel (supplied) into the hole and introduce about 1.5 kg of salt. It is normal for a small amount of water to come out of the salt container.

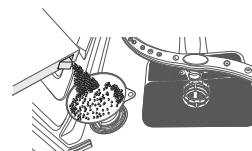

4. Carefully screw the cap back on.

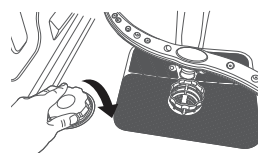



5. Usually, the salt warning light will be off after the salt container is filled with salt.

-  • The salt container must be refilled when the salt warning light on the control panel comes on. Although the salt container is filled enough, the indicator light may not switch off until the salt fully dissolves. If there is no salt warning light on the control panel, you can judge when to load the salt into the softener by the cycles that the dishwasher has run.
- If a lot of salt is spilt inside the dishwasher, run a pre wash program to reduce the spillage.

USING DETERGENT

All dishwasher cycles require detergent in the detergent compartment. Add the correct amount of detergent for the selected cycle to ensure the best performance.

-  **CAUTION:** Use dishwasher detergent only. Regular detergent produces too much foam, which may decrease the dishwasher's performance or cause it to malfunction.
-  **WARNING:** Do not swallow dishwasher detergent. Avoid breathing in the fumes. Dishwasher detergent contains irritants and caustic chemicals that can induce respiratory conditions. If you have swallowed dishwasher detergent or inhaled the fumes, seek medical attention immediately.
-  **WARNING:** Keep dishwasher detergent out of the reach of children.

Filling the detergent dispenser

DW60M6043F*

1. Open the detergent dispenser flap by pushing the detergent dispenser release catch.

 The flap is always open at the end of a dishwashing cycle.

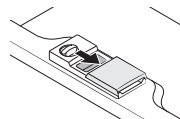
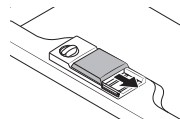

2. Add the recommended amount of detergent to the main wash detergent compartment.

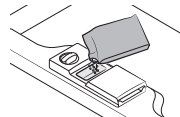

3. Close the flap by sliding it to the left and then pressing it down.

 There is no separate button that is specific to using tablet detergents.

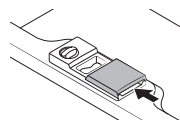

4. For better cleaning result, especially if you have very dirt items, add small amount (about 8 g) of detergent on the door. That will act in prewash phase.

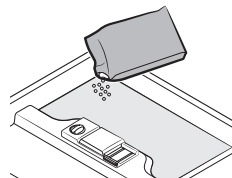

Using the detergent and water softener

DW60M5043F*/DW60M5042F*

1. Open the detergent dispenser flap by pushing the detergent dispenser release catch.

 The flap is always open at the end of a dishwashing cycle.

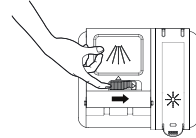

2. Add the recommended amount of detergent to the main wash detergent compartment.

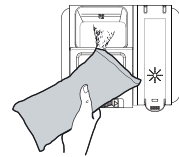

3. Close the flap by sliding it to the left and then pressing it down.

 There is no separate button that is specific to using tablet detergents.

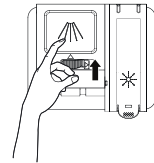

4. For better cleaning result, especially if you have very dirt items, add small amount (about 8 g) of detergent on the door. That will act in prewash phase.

USING RINSE AID

Filling the rinse aid reservoir

When the Rinse Refill indicator lights up on the control panel, refill with rinse aid.

Your dishwasher has been designed to use liquid rinse aid only.

Using a powdered rinse aid will clog the reservoir opening and cause the dishwasher to malfunction.

Rinse aid improves the drying performance of the dishwasher.

 **CAUTION:** Do not add regular detergent to the rinse aid reservoir.

DW60M6043F*

1. Remove the rinse aid reservoir cap by rotating it counterclockwise.

 Adding rinse aid to tablet detergents will improve drying performance.

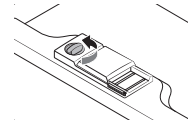

2. Fill the rinse aid reservoir with rinse aid.

 Use the viewing port when filling the rinse aid reservoir.

 **CAUTION:** Do not fill the reservoir above the full level indicator.
Excess rinse aid can overflow during the wash cycle.

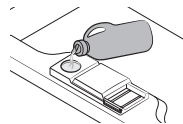

3. Turn the rinse aid indicator dial to a number between 1 and 6. The higher the number, the more rinse aid the dishwasher uses. If you are unable to rotate the rinse aid dial easily, try using a coin.
4. Close the rinse aid reservoir cap by rotating it clockwise.

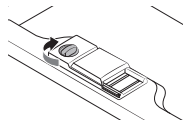

DW60M5043F*/DW60M5042F*

1. Remove the rinse aid reservoir cap by lifting up the handle.

 Adding rinse aid to tablet detergents will improve drying performance.

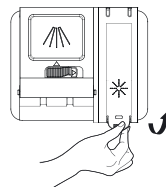

2. Fill the rinse aid reservoir with rinse aid.

 Use the viewing port when filling the rinse aid reservoir.

 **CAUTION:** Do not fill the reservoir above the maximum level. Excess rinse aid can overflow during the wash cycle.

 To set the rinse aid consumption, refer to the “Setting mode” section on page 19.

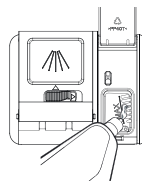

3. Close the cap after all.

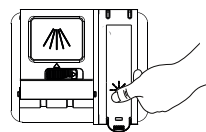

Using the detergent and water softener

HOW TO USE THE MULTI TAB OPTION

Your dishwasher has a **Multi tab** option which allows the replacement of salt and rinse aid with a Multi detergent tablets. This option can select on Intensive70, Eco program only.

 The **Multi tab** setting is only for use with Multi detergent tablets. If using Multi detergent tablets without this option, the appliance will not get its best performance.

1. Put the Multi detergent tablet into the container then start the **Multi tab** option.
2. Close the lid and press until it locks in place.

 When using Multi detergent tablet ensure that the lid can be closed correctly.

 **ATTENTION:** Keep all detergents in a safe place out of children's reach. Always add the detergent in the dispenser just before starting the dishwasher.

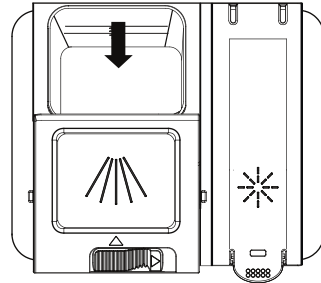

SETTING MODE

You can change the sound, auto door open function, rinse aid level, and water hardness setting to your preference.

Entering the Setting mode

1. Turn the dishwasher on.
2. Press and hold the **Program** button for five seconds within 60 seconds from turning on the dishwasher.

When you entered the Setting mode, the display will show

- "0:00" (DW60M6043F* / DW60M5043F*)
- Current water hardness setting (DW60M5042F*)
 - Default setting : H3

Water hardness level setting

You can change the water hardness level according to water hardness in your local area. Changing this setting will have effect on the salt consumption in the dishwasher's salt storage.

DW60M6043F* / DW60M5043F*

1. Press the **Hygiene** button to select the water hardness level setting menu.
 - The display will show the current setting.
 - Default setting: "H3"
2. Press the **Program** button to change the setting.
 - You can select from H1 – H6 (soft – hard).
3. Wait 5 seconds to save the setting.

DW60M5042F*

1. The display will show the current setting.
 - Default setting: "H3"
2. Press the **Program** button to change the setting.
 - You can select from H1 – H6 (soft – hard).
3. Wait 5 seconds to save the setting.



- Change the setting according to the table in the "**Water softener**" section on page **13**.
- The dishwasher regenerates the water softener once every 3-4 cycles depending on the setting. However, the dishwasher will regenerate the water softener on the first cycle after you change the setting.

Rinse aid level setting (applicable models only)

You can change the amount of rinse aid applied during a cycle.

1. Press the **Delay start** button to select the rinse aid level setting menu.
 - The display shows the current setting.
 - Default setting
 - DW60M5043F*: "F4"
 - DW60M5042F*: "d4"
2. Press the **Program** button to change the setting.
 - DW60M6043F* / DW60M5043F*: You can select from F1 – F5 (minimum – maximum)
 - DW60M5042F*: You can select from d1 – d5 (minimum – maximum)
3. Wait 5 seconds to save the setting.



DW60M6043F* model has the rinse aid indicator dial so that can change the setting by hand.

Sound setting (applicable models only)

You can turn the sound on or off.

1. Press the **Half load** button to select the sound setting menu.
2. Press the **Program** button to change the setting.
 - U0: Sound off
 - U1: Sound on
3. Wait 5 seconds to save the setting.



DW60M5042F* models have no sound setting mode.

Auto door open function setting (applicable models only)

1. You can set the dishwasher to automatically open the door after each cycle for better drying results.
2. Press the **Multi tab** button to select the auto door open function setting menu.
3. Press the **Program** button to change the setting.
 - A0: Function disabled
 - A1: Function enabled
4. Wait 5 seconds to save the setting.



DW60M5042F* models have no auto door open function setting mode.

Loading the dishwasher racks

For best performance of the dishwasher, follow these loading guidelines. Features and appearance of racks and silverware baskets may vary from your model.

Attention before or after loading the dishwasher racks

Scrape off any large amounts of leftover food. It is not necessary to rinse the dishes under running water. Place objects in the dishwasher in the following order:

1. Items such as cups, glasses, pots/pans, etc. are stood upside down.
 2. Curved items, or those with recesses, should be at a slant so that water can run off.
 3. Ensure they are stacked securely and can not tip over.
 4. Ensure they do not prevent the spray arms from rotating while washing takes place.
- Very small items should not be washed in the dishwasher as they could easily fall out of the racks.

Removing the dishes

To prevent water dripping from the upper basket into the lower basket, we recommend that you empty the lower basket first and then the upper basket.

LOADING THE UPPER BASKET

The upper basket is designed to hold more delicate and lighter dishware such as glasses, coffee and tea cups and saucers, as well as plates, small bowls and shallow pans (as long as they are not too dirty). Position the dishes and cookware so that they will not get moved by the spray of water. Always place glasses, cups & bowls upside down.

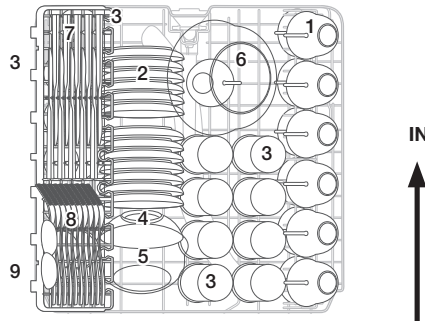

Saucers



Glasses



Small serving bowl



Medium serving bowl



Large serving bowl



Knives



Forks



Soup spoons

Loading the dishwasher racks

Adjusting the Upper Basket

The height of the upper basket can be adjusted in order to create more space for large utensils both for the upper/lower basket.

DW60M6043F*

1. To lower the upper rack, press the "A" levers located at the left and right sides of the upper basket and push the upper basket downwards slightly at the same time.
2. To raise the upper rack, just pull the upper basket upwards without operating any levers.

⚠ CAUTION: We recommend adjusting the height of the upper basket before loading dishes into the basket. If you adjust the the basket after loading the dishes, you may damage the dishes.

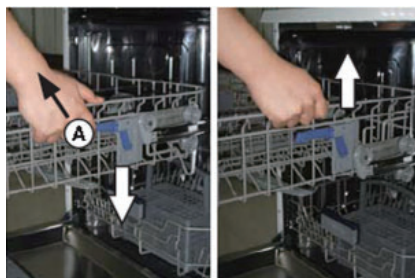

To lower position

To upper position

DW60M5043F*/DW60M5042F*

You can adjust the height of the upper rack in your Samsung dishwasher so that the lower rack can accommodate larger sized dishes. With the upper rack set at the highest position, the lower rack can accommodate plates up to 12 in. (30 cm) in diameter and the upper rack can accommodate plates up to 8 in. (20 cm) in diameter.

1. To lower the upper rack by 2 in. (5 cm), remove the upper rack. Then, reinsert the rack so that the upper four wheels on each side of the rack are above and below the guide rail.
 - See the **Lower position (A)** illustration to the left.
2. To raise the upper rack, remove the upper rack. Then, reinsert the rack so that the lower three wheels on each side of the rack are above and below the guide rail.
 - See the **Upper position (B)** illustration to the left.

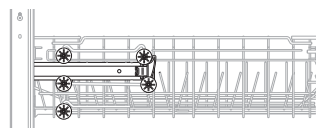

Lower position (A)

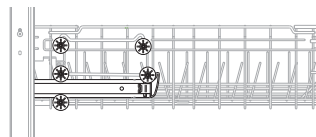

Upper position (B)

⚠ CAUTION: We recommend adjusting the height of the upper rack before loading dishes into the rack. If you adjust the rack after loading the dishes, you may damage the dishes.

LOADING THE LOWER BASKET

We recommend that you place large items which are most difficult to clean in to the lower rack: pots, pans, lids, serving dishes and bowls, as shown in the figure to the right.

It is preferable to place serving dishes and lids on the side of the racks in order to avoid blocking the rotation of the top spray arm. Pots, serving bowls, etc. must always be placed top down.

Deep pots should be slanted to allow water to flow out.

The bottom rack feature fold down tine rows so that larger or more pots and pans can be loaded.

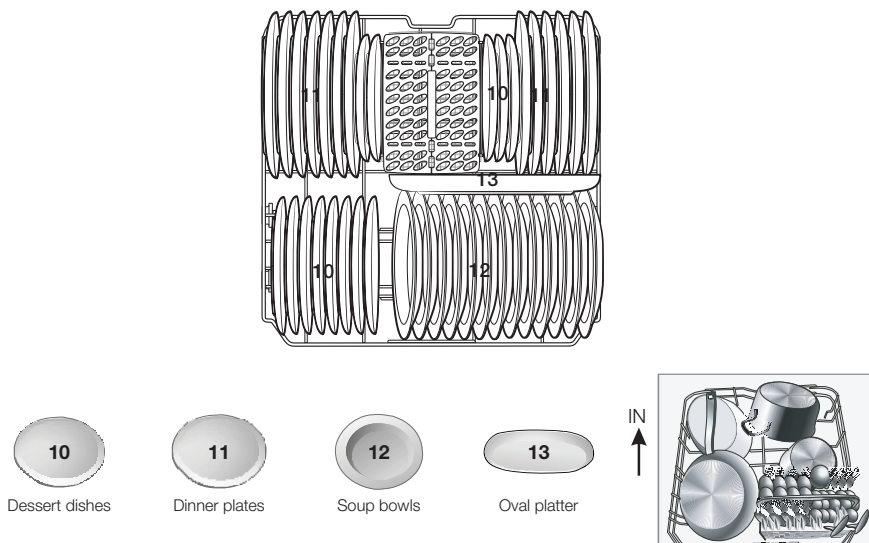

- ☑ Long items, serving cutlery, salad servers and big knives should be placed on the shelf so that they do not obstruct the rotation of the spray arms.

FOLDING SPIKES OF LOWER BASKET (APPLICABLE MODELS ONLY)

For better stacking of pots and pans, the spikes can be folded down as show in the picture below.

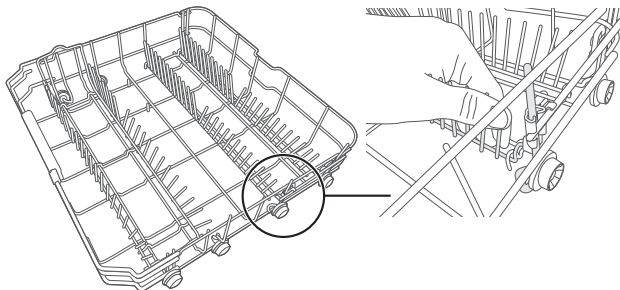







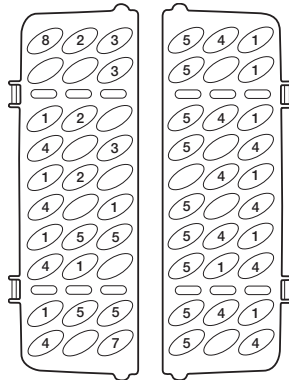
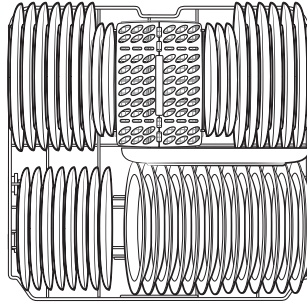

- ☑ DW60M5042F* and DW60M5043F* models have no the folding spikes.

Loading the dishwasher racks

CUTLERY(SILVERWARE) TRAY

Silverware should be placed in the cutlery tray with handles at the bottom: The spoon should be loaded individually into the appropriate slots, especially long utensils should be placed in the horizontal position at the front of the upper basket.



1	Soup spoons		5	Dessert spoons	
2	Forks		6	Serving spoons	
3	Knives		7	Serving forks	
4	Teaspoons		8	Gravy ladles	





WARNING

- Do not let any item extend through the bottom.
- Always load sharp utensils with the sharp point down!

FOR WASHING IN THE DISHWASHER THE FOLLOWING CUTLERY/ DISHES

Not suitable	Limited suitability
Plastic items that are not heat resistant. Older cutlery with glued parts that is not temperature resistant. Bonded cutlery items or dishes. Pewter or Copper items Lead crystal glass. Steel items subject to rusting. Wooden platters. Items made from synthetic fibres.	Some types of glasses can become dull after a large number of washes. Silver and aluminium parts have a tendency to discolour during washing. Glazed patterns may fade if machine washed frequently.

-  Do not try and wash items soiled with cigarette ash, candle wax, lacquer or paint. If you buy new dishes please make sure that they are suitable for dishwashers.
-  Please do not overload your dishwasher. Do not use any dish that are not suitable for dishwashers. This is important for good results and for reasonable energy consumption.

When loading the dishes and cutlery

Dishes and cutlery must not impede the rotation of the spray arms.

Load hollow items such as cups, glasses, pans etc. with the opening downwards so that water cannot collect in the container or a deep base.

-  Dishes and items of cutlery must not lie inside one another, or cover each other
 - To avoid damage to glasses, they must not touch.
 - Load large items which are most difficult to clean into the lower rack.
 - The upper rack is designed to hold more delicate and lighter dishware such as glasses, coffee and tea cups.



ATTENTION

Long bladed knives stored in an upright position are a potential hazard!

Long and/or sharp items of cutlery such as carving knives must be positioned horizontally in the upper basket.

Damage to glassware and other dishes.

Possible causes	Suggested remedy
<ul style="list-style-type: none"> • Type of glass or manufacturing process. • Chemical composition of detergent. • Water temperature and duration of dishwasher programme. 	<ul style="list-style-type: none"> • Use glassware or porcelain dishes that have been marked dishwasher-proof by the manufacturer. • Use a mild detergent that is described as kind of dishes. If necessary, seek further information from detergent manufacturers. • Select a programme with as low a temperature. • To prevent damage, take glass and cutlery out of the dishwasher as soon as possible after the programme has ended.

Washing programmes

TURNING ON THE APPLIANCE

Starting a cycle wash

1. Draw out the lower and upper basket, load the dishes and push them back.
It is recommended to load the lower basket first, then the upper one (see the section entitled "Loading the dishwasher racks").
2. Pour in the detergent (see the section entitled "Using the detergent and water softener").
3. Insert the plug into the socket. The power supply is 220-240 V~, 50 Hz, the specification of the socket is 10 A 250 VAC. Make sure that the water supply is turned on to proper pressure.
4. Close the door, press the **POWER** button, to switch on the machine.



A click could be heard when the door is closed perfectly. When the washing is over, you can shut off the switch by pressing **POWER** button.

CHANGE THE PROGRAMME

Premise:

1. A cycle that is underway can only be modified if it has only been running for a short time. Otherwise, the detergent may have already been released, and the appliance may have already drained the wash water. If this is the case, the detergent dispenser must be refilled (see the section entitled "Filling the detergent dispenser").
2. Press **POWER** button or **START** button for 3 seconds to cancel the programme, and turn on it again, then you can change the programme to the desired cycle setting.



If you open the door during a wash cycle, the machine will pause. The program light will stop blinking and the buzzer will beep every minute unless you close the door. After you close the door, the machine will keep on working after 3 seconds automatically.

If your model has broken memory function, the machine will go on to finish the selected program after the power cut.

Adding dishes

A forgotten dish can be added at any time before the detergent dispenser opens.

1. Open the door a little to stop the washing.
2. After the spray arms stop working, you can open the door completely.
3. Add forgotten dishes.
4. Close the door, the dishwasher will work after ten seconds.



WARNING: It is dangerous to open the door when washing, because the hot water may scald you. If the door is opened while the dishwasher is running, a safety mechanism is activated and stops the cycle.

AT THE END OF THE WASH CYCLE

When the working cycle has finished, the buzzer of dishwasher will beep shortly, then stop. In the digital display appears "0", only in this case the programme has ended.

1. Switch off the dishwasher by pressing the **POWER** button.
2. Turn off the water tap!

 **Open the door carefully. Hot steam may escape when the door is opened!**

- Hot dishes are sensitive to knocks. The dishes should be allowed to cool down around 15 minutes before removing from the appliance.
- Open the dishwasher's door, leave it and wait a few minutes before removing the dishes. In this way they will be cooler and the drying will be improved.
- Unloading the dishwasher.



It is normal that the dishwasher is wet inside.

Empty the lower basket first and then the upper one. This will avoid water dripping from the upper basket onto the dishes in the lower one.

Washing programmes

WASH CYCLE TABLE

DW60M6043F*

Program	Description of Cycle	Running time (min.)	Energy (kWh)	Water (ℓ)
Intensive70	Pre Wash (50 °C)	219	1.72	16.1
	Wash (65 °C)			
	Rinse			
	Rinse			
	Rinse (70 °C)			
	Drying			
ECO	Wash (50 °C)	210	0.822	10.5
	Rinse			
	Rinse (50 °C)			
	Drying			
Delicate	Pre Wash (40 °C)	120	0.90	13.5
	Wash (50 °C)			
	Rinse			
	Rinse (50 °C)			
	Drying			
Express	Wash (55 °C)	60	0.84	11.5
	Rinse			
	Rinse (50 °C)			
	Drying			
Auto	Pre Wash (45 °C)	80 - 150	1.05 - 1.55	10.5 - 16.0
	Wash (55-65 °C)			
	Rinse			
	Rinse			
	Rinse (50-55 °C)			
	Drying			
Pre Wash *	Pre Wash	15	0.02	4.0



- Pre Wash *: Continuous use of the Pre Wash cycle for an extended time is not recommended. This may reduce the performance of the water softener.
- The power consumption and cycle time depends on the water temperature and/or load.

DW60M5043F*

Program	Description of Cycle	Running time (min.)	Energy (kWh)	Water (ℓ)
Intensive70	Pre Wash (50 °C)	220	1.69	18.2
	Wash (65 °C)			
	Rinse			
	Rinse (70 °C)			
	Drying			
ECO	Wash (50 °C)	198	1.039	12.0
	Rinse			
	Rinse (50 °C)			
	Drying			
Delicate	Pre Wash (40 °C)	120	0.90	15.2
	Wash (50 °C)			
	Rinse (50 °C)			
	Drying			
Express	Wash (55 °C)	60	0.78	11.4
	Rinse			
	Rinse (50 °C)			
	Drying			
Normal	Pre Wash (45 °C)	175	1.24	18.7
	Wash (55 °C)			
	Rinse			
	Rinse (60 °C)			
	Drying			



The power consumption and cycle time depends on the water temperature and/or load.

DW60M5042F*

Program	Description of Cycle	Running time (min.)	Energy (kWh)	Water (ℓ)
Intensive70 (DW60M5042F*)	Pre Wash (50 °C)	170	1.6	17.5
	Wash (60 °C)			
	Rinse			
	Rinse (70 °C)			
	Drying			
ECO	Wash (45 °C)	195	1.039	12.0
	Rinse			
	Rinse (65 °C)			
	Drying			
Delicate	Pre Wash	130	0.95	14.5
	Wash (40 °C)			
	Rinse (60 °C)			
	Drying			
Normal	Pre Wash (45 °C)	180	1.35	15.0
	Wash (55 °C)			
	Rinse			
	Rinse (65 °C)			
	Drying			



The power consumption and cycle time depends on the water temperature and/or load.

Cleaning and care

CLEANING THE FILTERS

Filtering system

For your convenience, we have placed the drain pump and filtering system within easy reach inside the tub. There are three components of the filtering system: the main filter, the coarse filter, and the fine filter.

- 1. Main filter:** Food and soil particles trapped by this filter are pulverized by a special jet on the lower spray arm and washed down the drain.
- 2. Coarse filter:** Larger items, such as pieces of bone or glass, that could clog the drain are trapped in the coarse filter. To remove an item caught in this filter, gently squeeze the tabs on top of this filter and lift it out.
- 3. Fine filter:** This filter holds soil and food residue in the sump area and prevents it from being redeposited on the dishes during a cycle.

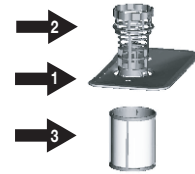

⚠ ATTENTION: Do not put the fine filter upside down.

Filter assembly

For best performance and results, the filter assembly must be cleaned. The filter efficiently removes food particles from the wash water, allowing it to be recirculated during the cycle. For this reason, it is a good idea to remove the larger food particles trapped in the filter after each wash cycle by rinsing the semicircular filter and cup under running water. To remove the filter assembly, turn it in anti-clockwise direction and lift the filter assembly up. The entire filter assembly should be cleaned regularly.

To clean the coarse filter and the fine filter, use a cleaning brush. Then, reinsert the entire assembly in the dishwasher, positioning in its seat, pressing downward, turning it clockwise direction.

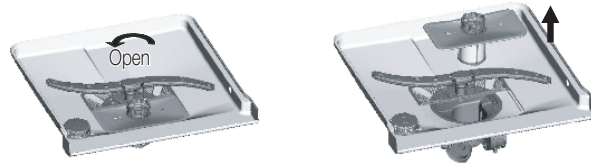

The dishwasher must never be used without the filters. Improper replacement of the filter may reduce the performance level of the appliance and damage dishes and utensils.

⚠ WARNING: Never run the dishwasher without the filters in place. When cleaning the filters, do not damage them. Otherwise the filters may not perform as intended and poor wash results or damage to the internal parts may be encountered.

Cleaning and care

CLEANING THE SPRAY ARMS

It is necessary to clean the spray arms regularly as hard water residue can clog the spray arm jets and bearings. To remove the middle spray arm, hold the nut, rotate the arm clockwise to remove it. To remove the lower spray arm, pull out the spray arm upward. Wash the arms in warm and soapy water and use a soft brush to clean the jets. Replace them after rinsing them thoroughly.

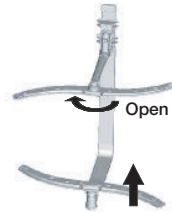

CLEANING THE DOOR

To clean the edge around the door, you should use only a soft warm, damp cloth.

Also, never use abrasive cleaners or scouring pads on the outer surfaces because they will scratch the finish. Some papers towels can also scratch or leave marks on the surface.

⚠ WARNING: Never use a spray cleaner to clean the door panel for it could damage the door lock and electrical components. It is not advised to use the abrasive agent or some paper towel because of the risk of scratching or leaving spots on the stainless steel surface.

CARING FOR THE DISHWASHER

To clean the control panel use a lightly damp cloth then dry thoroughly. To clean the exterior use a good appliance polish wax.

Never use sharp objects, scouring pads or harsh cleaners on any part of the dishwasher.

PROTECT AGAINST FREEZING

If your dishwasher is left in an unheated place during the winter:

1. Cut off electrical power to the dishwasher.
2. Turn off the water supply and disconnect the water inlet pipe from the water valve.
3. Drain water from the inlet pipe and water valve. (Use a pan to catch the water)
4. Reconnect the water inlet pipe to the water valve.
5. Remove the filter in the tub the bottom and use a sponge sock up water.

HOW TO MAINTAIN YOUR DISHWASHER

- **After Every Wash**

After every wash, turn off the water supply to the appliance and leave the door slightly ajar so that moisture and odours not trapped inside.

- **Remove the Plug**

Before cleaning or performing maintenance, always remove the plug from the socket.

- **No Solvents or Abrasive cleaning**

To clean the exterior and rubber parts of the dishwasher, do not use solvents or abrasive cleaning products. Use only a cloth and warm soapy water. To remove spots or stains from the surface of the interior, Use a cloth dampened with water and a little white vinegar, or a cleaning product made specifically for dishwashers.

- **When You Go on Holiday**

When you go on holiday, it is recommended that you run a wash cycle with the dishwasher empty and then remove the plug from the socket, turn off the water supply and leave the door of the appliance slightly ajar. This will help the seals last longer and prevent odours from forming within the appliance.

- **Moving the Appliance**

If the appliance must be moved, try to keep it in the vertical position. If absolutely necessary, it can be positioned on its back.

- **Seals**

One of the factors that cause odours to form in the dishwasher is food that remains trapped in the seals. Periodic cleaning with a damp sponge will prevent this from occurring.

Setting up your dishwasher



WARNING : Electrical shock hazard

Disconnect electrical power before installing dishwasher.

Failure to do so could result in death or electrical shock.

⚠ ATTENTION: The installation of the pipes and electrical equipments should be done by professionals.

About electricity connecting



CAUTION, for personal safety:

DO NOT USE AN EXTENSION CORD OR AN ADAPTER PLUG WITH THIS APPLIANCE.
DO NOT, UNDER ANY CIRCUMSTANCES, CUT OR REMOVE THE THIRD GROUNDING PRONG FROM THE POWER CORD.

Electrical requirements

- An 220-240 V~, 50 Hz fuse or a circuit breaker.
- An individual branch circuit serving your dishwasher.

Grounding instructions



Insure proper ground exists before use



This appliance must be grounded. In the event of a malfunction or breakdown, grounding will reduce the risk of electric shock by providing a path of least resistance of electric current. This appliance is equipped with a cord having an equipment-grounding conductor and a grounding plug. The plug must be plugged into an appropriate outlet that is installed and grounded in accordance with all local codes and ordinances.



WARNING: Improper connection of the equipment grounding conductor can result in the risk of an electric shock. Check with a qualified electrician or service representative if you are in doubt whether the appliance is properly grounded. Do not modify the plug provided with the appliance.

WATER SUPPLY AND DRAIN

Cold water connection

Connect the cold water supply hose to a threaded 3/4 (inch) connector and make sure that it is fastened tightly in place.

If the water pipes are new or have not been used for an extended period of time, let the water run to make sure that the water is clear. This precaution is needed to avoid the risk of the water inlet to be blocked and damage the appliance.



Provided water supply hose has the aqua-safe system (DW60M6043F*). Ensure that water supply hose's aqua-safe pipe is connected to the faucet.



Hot water connection

The water supply to the appliance can also be connected to the house hot water line (centralized system, heating system), as long as it does not exceed a temperature of 60 °C. In this case, the wash cycle time will be shortened by about 15 minutes and the wash efficiency slightly reduced. The connection must be made to the hot water line following the same procedures as those for the connection to the cold water line.



Positioning the appliance

Position the appliance in the desired location. The back should rest against the wall behind it, and the sides, along the adjacent cabinets or wall. The dishwasher is equipped with water supply and drain hoses that can be positioned to the right or the left to facilitate proper installation.

How to drain excess water from hoses

If the sink is 1000 mm higher from the floor, the excess water in hoses cannot be drained directly into the sink. It will be necessary to drain excess water from hoses into a bowl or suitable container that is held outside and lower than the sink.

Water outlet

Connect the water drain hose. The drain hose must be correctly fitted to avoid water leaks. Ensure that the water inlet hose is not kinked or squashed.

Extension hose

If you need a drain hose extension, Use a similar size and quality drain hose.

It must be no longer than 4 metres; otherwise the cleaning effect of the dishwasher could be reduced.

Syphon connection

The waste connection must be at a height of between 30 cm (minimum) and 80 cm (maximum) from the bottom of the dishwasher. The water drain hose should be fixed by a hose clip.

Aqua-safe

The Aqua-safe System is a safety valve system, preventing water leaks. If the water inlet hose starts to leak anytime, the safety valve cuts off the running water. If the water inlet hose or the safety valve is damaged, remove and replace it.

Do not enlarge or shorten the inlet hose.

Setting up your dishwasher

CONNECTION OF DRAIN HOSES

Insert the drain hose into a drain pipe with a minimum diameter of 4 cm, or let it run into the sink, making sure to avoid bending or crimping it. The top of the hose must be at a height between 30 and 80 cm. The free end of the hose must not be immersed in water to avoid the back flow of it.

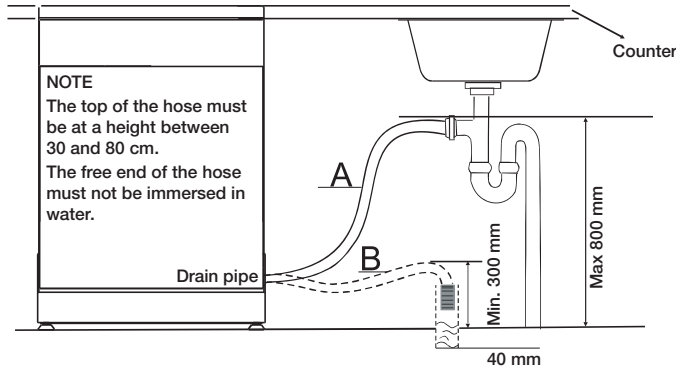

POSITION THE APPLIANCE

Position the appliance in the desired location. The back should rest against the wall behind it, and the sides, along the adjacent cabinets or walls. The dishwasher is equipped with water supply and drain hoses that can be positioned either to the right or the left sides to facilitate proper installation.

Levelling the Appliance

Once the appliance is positioned for levelling, the height of the dishwasher may be altered via adjustment of the screwing level of the feet. In any case, the appliance should not be inclined more than 2°.

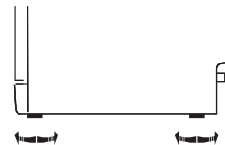

START OF DISHWASHER

The following should be checked before starting the dishwasher.

1. the dishwasher is level and fixed
2. the inlet valve is opened
3. There is no leakage at the connections of the conducts
4. the wires are tightly connected
5. the power is switched on
6. the inlet and drain hoses are not knotted
7. All packaging materials and printings have been taken out of the dishwasher

⚠ ATTENTION: After installation please put this manual in a safe place. The contents of this manual can be useful to users.

Troubleshooting

The manufacturer, following a policy of constant development and up-dating of the product, may make modifications without giving prior notice.

BEFORE CALLING FOR SERVICE

PROBLEM	POSSIBLE CAUSE	WHAT TO DO
Dishwasher doesn't run	<ul style="list-style-type: none"> Fuse blown or the circuit breaker tripped. 	<ul style="list-style-type: none"> Replace fuse or reset circuit breaker. Remove any other appliances sharing the same circuit with the dishwasher.
	<ul style="list-style-type: none"> Power supply is not turned on. 	<ul style="list-style-type: none"> Make sure the dishwasher is turned on and the door is closed securely. Make sure the power cord is properly plugged into the wall socket.
	<ul style="list-style-type: none"> Water pressure is low. 	<ul style="list-style-type: none"> Check that the water supply is connected properly and the water is turned on.
Drain pump doesn't stop	<ul style="list-style-type: none"> Overflow. 	<ul style="list-style-type: none"> The system is designed to detect an overflow. When it does, it shuts off the circulation pump and turns on the drain pump.
Noise	<ul style="list-style-type: none"> Some audible sounds are normal. 	<ul style="list-style-type: none"> Sound from soft food shredding action and detergent cup opening.
	<ul style="list-style-type: none"> Utensils are not secure in the baskets or something small has dropped into the basket. 	<ul style="list-style-type: none"> To ensure everything is secured in the dishwasher.
	<ul style="list-style-type: none"> Motor hums. 	<ul style="list-style-type: none"> Dishwasher has not been used regularly. If you do not use it often, remember to set it to fill and pump out every week, which will help keep the seal moist.
Suds in the tub	<ul style="list-style-type: none"> Improper detergent. 	<ul style="list-style-type: none"> Use only the special dishwasher detergent to avoid suds. If this occurs, open the dishwasher and let suds evaporate. Add 1 gallon of cold water to the tub. Close and latch the dishwasher, then start the "soak" wash cycle to drain out the water. Repeat if necessary.
	<ul style="list-style-type: none"> Spilled rinse agent. 	<ul style="list-style-type: none"> Always wipe up rinse agent spills immediately.
Stained tub interior	<ul style="list-style-type: none"> Detergent with colorant was used. 	<ul style="list-style-type: none"> Make sure that the detergent is the one without colorant.
Dishes are not dried	<ul style="list-style-type: none"> Rinse agent dispenser is empty. 	<ul style="list-style-type: none"> Make sure that the rinse agent dispense is filled.
Dishes and flatware not clean	<ul style="list-style-type: none"> Improper program. 	<ul style="list-style-type: none"> Select a more Intensive70 wash program.
	<ul style="list-style-type: none"> Improper rack loading. 	<ul style="list-style-type: none"> Make sure that the action of the detergent dispenser and spray arms are not blocked by large dishware.

Troubleshooting

PROBLEM	POSSIBLE CAUSE	WHAT TO DO
Spots and filming on glasses and flatware	<ol style="list-style-type: none"> Extremely hard water. Low inlet temperature. Overloading the dishwasher. Improper loading. Old or damp powder detergent. Empty rinse agent dispenser. Incorrect dosage of detergent. 	<p>To remove spots from glassware:</p> <ol style="list-style-type: none"> Take out all metal utensils out of the dishwasher. Do not add detergent. Choose the longest cycle. Start the dishwasher and allow it to run for about 18 to 22 minutes, then it will be in the main wash. Open the door to pour 2 cups of white vinegar into the bottom of the dishwasher. Close the door and let the dishwasher complete the cycle. If the vinegar does not work: Repeat as above, except use 1/4 cup (60 ml) of citric acid crystals instead of vinegar.
Cloudiness on glassware	<ul style="list-style-type: none"> Combination of soft water and too much detergent. 	<ul style="list-style-type: none"> Use less detergent if you have soft water and select a shortest cycle to wash the glassware and to get them clean.
Yellow or brown film on inside surfaces	<ul style="list-style-type: none"> Tea or coffee stains. 	<ul style="list-style-type: none"> Using a solution of 1/2 cup of bleach and 3 cups warm water to remove the stains by hand. <p>⚠ WARNING: Wait for 20 minutes after a cycle to allow heating elements cool down before cleaning interior; Failing to follow this instruction may result in injury.</p>
	<ul style="list-style-type: none"> Iron deposits in water can cause an overall film. 	<ul style="list-style-type: none"> Contact a water softener company to install specialist water filtration system on the water supply.
White film on inside surface	<ul style="list-style-type: none"> Hard water minerals. 	<ul style="list-style-type: none"> Clean the interior, use specialist dishwasher cleaner or use a damp sponge with dishwasher detergent and wear rubber gloves. Never use any other cleaner than dishwasher detergent for the risk of foaming or suds.
Detergent cup lid won't latch	<ul style="list-style-type: none"> Dial is not in the OFF position. 	<ul style="list-style-type: none"> Turn the Dial to OFF position and slide the door latch to the left.
Detergent left in dispenser	<ul style="list-style-type: none"> Dishes block detergent dispenser. 	<ul style="list-style-type: none"> Re-loading the dishes properly.
Steam	<ul style="list-style-type: none"> Normal phenomenon. 	<ul style="list-style-type: none"> There is some steam coming through the vent by the door latch during drying and water draining.
Black or gray marks on dishes	<ul style="list-style-type: none"> Aluminum utensils have rubbed against dishes. 	<ul style="list-style-type: none"> Use a mild abrasive cleaner to eliminate those marks.
Water standing in the bottom of the tub	<ul style="list-style-type: none"> This is normal. 	<ul style="list-style-type: none"> A small amount of clean water around the outlet on the tub bottom keeps the water seal lubricated.

PROBLEM	POSSIBLE CAUSE	WHAT TO DO
Dishwasher leaks	<ul style="list-style-type: none"> Overfill dispenser or rinse aid spills. 	<ul style="list-style-type: none"> Be careful not to overfill the rinse aid dispenser. Spilled rinse aid could cause overusing and lead to overflowing. Wipe away any spills with a damp cloth.
	<ul style="list-style-type: none"> Dishwasher isn't level. 	<ul style="list-style-type: none"> Make sure the dishwasher is level.
Buttons are not working on power on state	<ul style="list-style-type: none"> Door is open. 	<ul style="list-style-type: none"> When door is opened, buttons are not working except POWER button. Close the door and press the button.
	<ul style="list-style-type: none"> Control lock function is selected. 	<ul style="list-style-type: none"> When selected Control lock function, buttons are not responded. To unlock this function, hold down the Control lock button for three (3) seconds. Also, Control lock function is released when power cord is reconnected.

 The result of washing performance may be caused by a power supply issue. Try another program before contacting for service.

INFORMATION CODES

When a fault occurs, the appliance will display information codes to warn you.

Codes	Meanings	Possible Causes
4C	Water supply check	Faucets is not opened, or water intake is restricted, or water pressure is too low
LC	Leakage	Some element of dishwasher leaks.
HC	Not reaching required temperature	Malfuction of heating element
PC	Divider valve failed	Divider valve failed
AC	Failure of communication between main PCB with sub PCB	Open circuit or break wiring for the communication
bC2	Button pressed long time	Button pressed 30 seconds

 **WARNING:** If overflow occurs, turn off the main water supply before calling a service. If there is water in the base pan because of an over fill or small leak, the water should be removed before restarting the dishwasher.

Appendix

SPECIFICATIONS

Model	DW60M6043F*	DW60M5043F*	DW60M5042F*
Type	Free Standing		
Power	220 - 240 V~, 50 Hz		
Water Pressure	0.04 - 1.0 MPa		
Rated Power Usage	1760 - 2100 W		
Hot water Connection	Max 60 °C		
Drying Type	Condensed Drying + Auto Door Open Drying System	Condensed Drying System	
Washing Type	Rotating Nozzle Spray		
Dimensions (Width x Depth x Height)	598 x 600 x 845 mm		
Washing Capacity	13 Place Settings		
Weight (Unpacked)	49.50 kg	41.50 kg	41.50 kg

PRODUCT DIMENSION

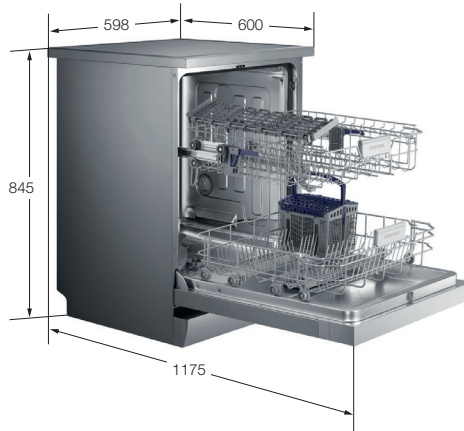

DW60M6043FS/DW60M5043FS
DW60M5042FS/DW60M5042FW

For standard test

DW60M6043F*/DW60M5043F*/DW60M5042F*

 The information for comparability test as follows:

- Washing capacity: 13 place settings
- Test standard: EN 50242
- Position of upper basket: to lower position
- Wash cycle: Eco
- Additional options: None
- Rinse aid setting: d5
- Water softener setting: H3
- Dosage of the standard detergent: Pre wash 5 g + Main wash 27.5 g
- For the arrangement of the items, refer below figures

<Upper basket>

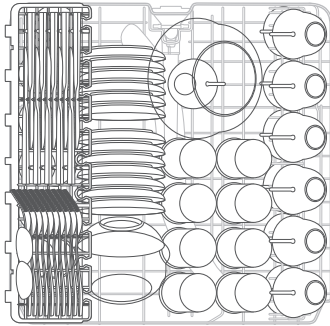



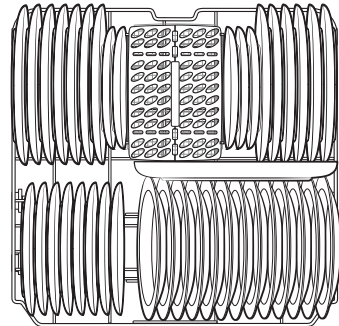



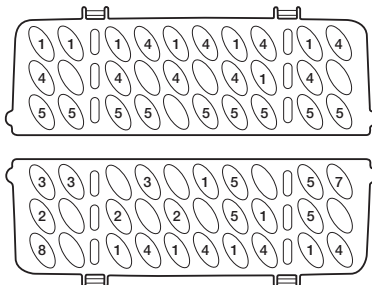

<Lower basket>



<Silverware basket>



1	Soup spoons	
2	Forks	
3	Knives	
4	Teaspoons	
5	Dessert spoons	
6	Serving spoons	
7	Serving forks	
8	Gravy ladles	

Terminology for dishwasher

1. Circulation Motor	A motor that sucks the water remaining on the floor of the dishwasher and injects water using high pressure through the internal water passages to the top Middle and lower nozzles.
2. Drain Pump	The pump that drains the polluted water from the dishwasher generated while the dishwasher is running.
3. Heater	The heater is located on the water passages inside the dishwasher. It heats the flowing water to increase wash efficiency.
4. Flow Meter	Measure the amount of supplied water by counting the pulses of the hall IC located at the next of the inlet valve.
5. Distributor	Located at the output end of the sump inside the dishwasher. It turns the flow of the water that goes to the bottom part of the dishwasher on or off. (This model does not have this part)
6. Dispenser	The location where the detergent and rinse aids are stored so they can be used by the dishwasher. The dispenser automatically supplies detergent and rinse aids to the inside of the dishwasher when they are needed.
7. Tub Assy	An internal case made of stainless steel that makes up the basic framework of the dishwasher.
8. Sump Assy	The place inside the dishwasher where water is collected. The injected water gathers here after circulation. The sump Assy is connected to the circulation motor and drain pump.
9. Inner Door Assy	An internal case made of stainless steel that makes up internal part of the front door.
10. Base Assy	A plastic part that makes up the basic bottom framework.
11. Basket Assy	The upper and lower racks where dishes can be loaded.
12. Middle/Lower Nozzles	Washes dishes by rotating and injecting the supplied water through the water passage at high pressure.
13. Case Brake	A passage that adjusts the air pressure by connecting the pressure of the inside air which is expanded at high temperature during wash and rinse cycles and the outside air pressure.
14. Door Lock Switch	Detects whether the door of the dishwasher is open or closed if the door is open while the dishwasher is running the cycle is temporary stopped.

Note

Note

SAMSUNG

QUESTIONS OR COMMENTS?

COUNTRY/LOCATION	CALL	OR VISIT US ONLINE AT
INDIA	1800 5 SAMSUNG (1800 5 7267864) (Toll-Free) 1800 40 SAMSUNG (1800 40 7267864) (Toll-Free)	www.samsung.com/in/support

This product is RoHS compliant.



DD81-02437S-04