

# Lifelong

## HOME SAFE LOCKER

User Manual

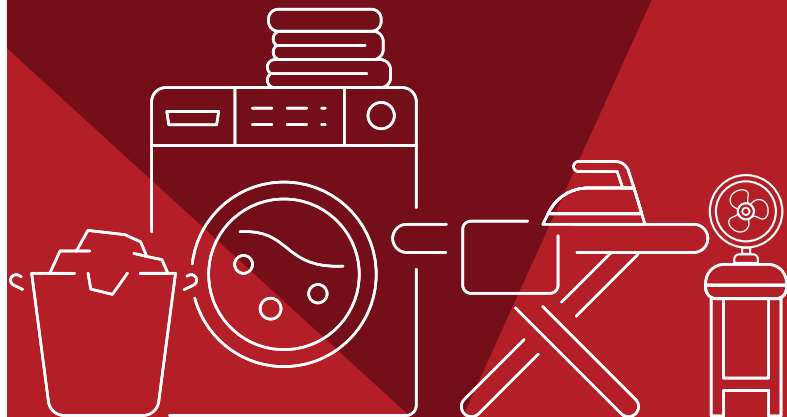

Manufactured for & Marketed by :  
**Lifelong Online Retail Private Limited**

For queries and complaints:  
please contact: [customercare@lifelongindia.com](mailto:customercare@lifelongindia.com)  
[www.lifelongindiaonline.com](http://www.lifelongindiaonline.com)

**Built for Home. Built for India.**

## INTRODUCTION:

Welcome to the Lifelong family.

Dear Customer,

Congratulations on purchasing Lifelong Home Safe 0.8 Cu. Ft with Led and a warm welcome to the Lifelong family.

At Lifelong, we take pride in developing quality products for your home, health and happiness. Through constant innovation in our products, we have been able to develop a wide spectrum of products across Home, Kitchen, Grooming and Wellness categories. We strive to enrich the lives of the modern consumer every day. Keeping that in mind, we have offered all our products at a fair and honest price.

We hope that this Home safe Lockers serves you and your family's needs without any hassles.

Thanks again for becoming a part of the Lifelong family. Enjoy using the product!

Warm Regards,  
Team Lifelong

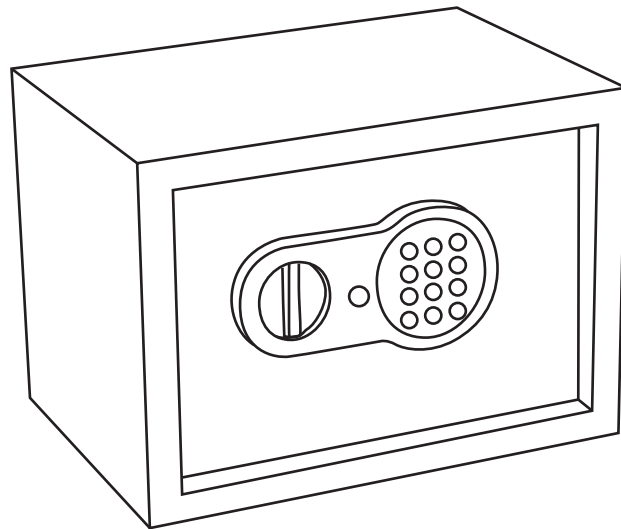

**LLHSL08**

## TABLE OF CONTENTS:

1. Mounting Method
2. Intelligent Electronic Safe
3. Opening your Safe for the first time
4. Inserting the Batteries
5. Opening Door
6. Closing Door
7. Automatic Lock
8. Setting the User Code
9. Setting Master Code
10. Opening the Safe with the Emergency Key
11. LED Light Functioning
12. Terms and Conditions
13. Warranty Card

## MOUNTING METHOD:

- Select a stable, dry and secure location for your safe.
  - If bolting to a wall, make sure that your safe is resting on a supporting surface (such as the floor or a shelf). Do not bolt your safe to both the floor and wall.
1. Place the safe on the selected location. Use a pencil to mark the mounting holes on the floor or wall.
  2. Move the safe and drill 2-inch-deep mounting holes (-50 mm) using the appropriate drill bit.
  3. Move the safe back in place, align the mounting holes to the openings in the safe. Insert the expansion bolts (included) through the holes and into the mounting holes and tighten them securely.

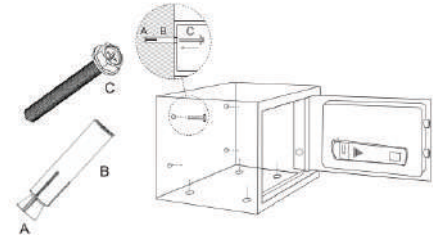

For any help, kindly consult the local distributor

## INTELLIGENT ELECTRONIC SAFE:

Please do not keep emergency keys in your safe!

### Schematic drawing of case

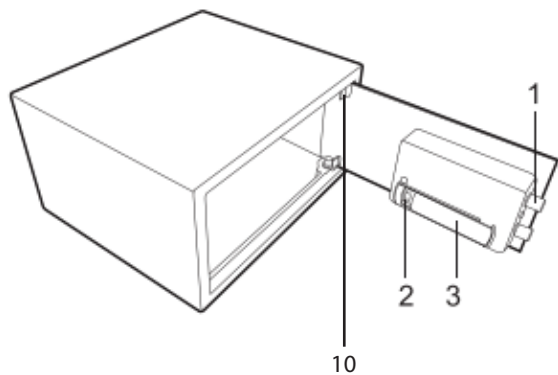

5

### Schematic drawing of control panel

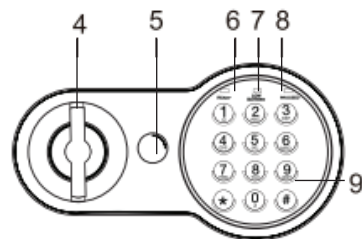

1. Bolts
2. Reset Button
3. Battery Compartment
4. Knob (Master Key)
5. Emergency Lock Cover
6. Green Light
7. Red Light
8. Yellow Light
9. Confirming button
10. LED Light

6

## OPENING YOUR SAFE FOR THE FIRST TIME:

To open the safe for the first time, please use the emergency key. The operation in details refers to "opening the safe with the emergency key".

- Remove emergency lock cover, then insert the emergency key, and turn it counter clockwise.
- Insert the emergency key, turn it counter clockwise, then turn the knob (master key) clockwise to open the door."

**CAUTION:** Finish operation, pull out the emergency key and keep it in a safe place.

## INSERTING THE BATTERIES:

- Open the door.
- Insert 4 X AA batteries into the battery compartment.
- Under normal condition both red and green lights are on at the same time. It means the voltage is low and you should insert new batteries.

**CAUTION:** Replace 4 batteries by lining them up in a manner as indicated by the "+" and "-" signs. You should reset the user's code after replace the batteries.

## OPENING DOOR:

- Input your user's code (3 to 8 digits), each press results in one beep and the yellow light flashes.
- Press "#" or "\*" confirming button, the green light will be on.
- Rotate the knob (master key) clockwise and pull outwards within 5 seconds, the door is opened.

**CAUTION:** The user preset code is "159". Please input the user code again if the yellow light flashes with beeps.

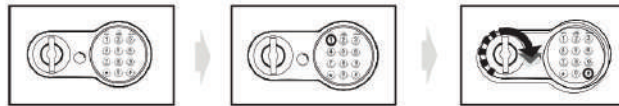

## CLOSING DOOR:

- Turn the knob (master key) counter clockwise to close the door.

## AUTOMATIC LOCK:

- 3 continuously wrong entries will activate the warning beeps.

**CAUTION:** The key pad would be disabled during the beeping. The beeping will stop automatically after approx 20 seconds or can also be stopped by opening the safe with emergency key & power-cut by removing the batteries.

## SETTING THE USER CODE:

- Open the safe, press the reset button, start setting code when the yellow light goes on.
- Input new code (3-8 digits), and press the “#” or “\*” button to confirm with beeps, which indicates the acceptance and storage of the new code.
- The beeping automatically stops after beeping for approx. 20 secs and if the customer wants to stop it before that then should use emergency or remove batteries or else beeping will stop automatically after few seconds.

## SETTING MASTER CODE:

- Open the safe, input “0” twice and press the reset button, start setting code when beeps and the yellow light goes on.
- Input the new master code (3-8 digits), then press “#” or “\*” button to confirm, it will be confirmed by beeps, setting is done successfully.
- If the yellow light flashes with beeps, it means the new code is invalid and should operate again.

## OPENING THE SAFE WITH THE EMERGENCY KEY:

Upon first receipt of the safe, or either the electronic circuit malfunction or codes unknown. You could also use the emergency key to open the safe.

- Remove the cover of the emergency lock.
- Insert the emergency key, turn it counter clockwise, then turn the knob (master key) clockwise to open the door.

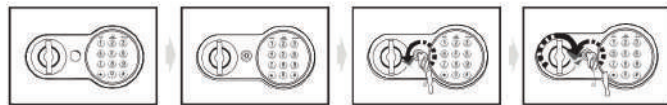

## LED LIGHT FUNCTIONING:

Post the batteries are inserted, on opening the door, LED will be automatically switched ON for 10 seconds and will be auto-off after 10 seconds.

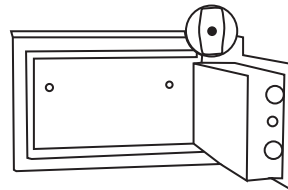

## Terms and Conditions:

1. This warranty is void if:
  - a. The completely filled warranty card is not presented at the time of servicing the product.
  - b. The product is not operated according to the instructions given under the user manual.
  - c. Damages are caused by lightning, abnormal voltage, water or other liquid intrusion, fire, flood, accident, negligence or improper handling.
  - d. Product has been damaged due to installation, repairs, alterations or modifications by unauthorized service organizations or persons.
  - e. Product label specifying the model number, serial number and production code has been removed and altered.
  - f. Defects or parts requiring replacement due to ordinary wear and tear, corrosion, rust or stains, scratches, dents on the casing or paintwork of the product.
  - g. Claims damaged and/or missing parts (accessories) after 7 days from the original date of goods received.
  - h. Defects or faults in product which have been used for commercial/industrial purposes or which have been rented/leased or have been otherwise subject to non-household/non-domestic use.
2. Repairs or replacements will be carried out by authorized service provider.
3. During the limited warranty period, Lifelong or its authorized service provider will repair without charge the defective unit inclusive of labor and parts and restore the unit to its optimum working condition. All defective parts used for the warranty repair should be surrendered to Lifelong and/or its authorised servicer.
4. All expenses incurred in collecting the unit (s) or part(s) thereof from authorised service provider as will as any other expenses and incidentals will be borne by the consumer.

5. Lifelong obligations are limited to the repair and replacement of the defective product. Except as set forth above, there are no other express or implied warranty and all warranted, conditions or other terms implied by statute or common law (including any warranty of satisfactory quality, merchantability or fitness for a particular purpose) are excluded to the fullest extent permitted by the law.
6. Lifelong total liability for damages relating to or arising out of the purchase or use of the product regardless of the type or cause of such damage of the form of characterization of the claim asserted (e.g. contract or tort) shall not exceed the original purchase price paid for the product.
7. However in no event shall Lifelong and Lifelong authorized distributors be liable for any punitive, special incidental, indirect or consequential losses or damages whatsoever (including without limitation, damages for the loss of revenue, business, profits, goodwill, or contracts, business interruptions, loss of business information or any other pecuniary loss.) Whether or not Lifelong has been advised of the possibility of such damages. These limitations shall apply not with standing the failure of the essential purpose of any limited warranty. This limited warranty does not affect consumer's statutory rights under the law.
8. No carrier, dealer or employee is thereof authorized to make modifications to this warranty and you should not rely on any such representation. Lifelong reserves the right to amend the terms and conditions if necessary.

## Consumer Warranty Card

Dear Customer,

Thank you for choosing a Lifelong consumer product. All Lifelong Consumer products are designed and manufactured to the highest standards to deliver high quality performance, as well as easy installation and use. At Lifelong, we believe in providing not only service, but adding value to your purchase. The warranty has therefore been designed especially for you with your interest at heart.

### Warranty Service

All Lifelong consumer products are covered against manufacturing defects from them date of purchase.

Name of the product: \_\_\_\_\_

Model: \_\_\_\_\_

Warranty coverage: 1 year

Please note: Purchase receipt is necessary for warranty verification.

Customer Care: [customercare@lifelongindia.com](mailto:customercare@lifelongindia.com)

### Customer Details

Name: \_\_\_\_\_

Address: \_\_\_\_\_

Home Number: \_\_\_\_\_

Office Number: \_\_\_\_\_

E-mail Address: \_\_\_\_\_

### Product Details

Model No.: \_\_\_\_\_

Serial No.: \_\_\_\_\_

Purchase Date: \_\_\_\_\_

Invoice Number: \_\_\_\_\_

Online Site: \_\_\_\_\_

Please log on to [www.lifelongindiaonline.com](http://www.lifelongindiaonline.com) and complete the online warranty form with your personal and product details within 14 days.