

Futuristic  
Design  
Comfort  
Control



**HYBRID+**  
Cassette | Ductable | Tower



Next Generation High Performance Airconditioning

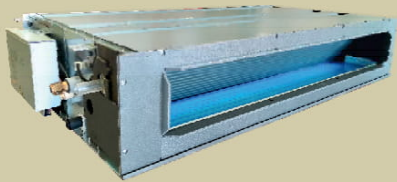

Country of Origin : Thailand





HYBRID+

## Next Generation High Performance Airconditioning

The PAC range from Mitsubishi Heavy Industries Thermal systems is ideal for air conditioning offices, shops, restaurants, and bars ... as well as other commercial environments. The versatility of the PAC range offers you a wide selection of models in function of your installation needs. The modern and attractive design of our indoor units is harmoniously integrated in any atmosphere creating a pleasant and relaxing environment.

### CONTENTS

Page

Non Inverter PAC Range	2
Product Features	3 - 4
Hybrid Cassette AC Overview	5 - 6
Remote Control Features	7 - 8
Hybrid Cassette AC	9 - 10
Hybrid Cassette Features/ Specs.	11 - 12
Hybrid Ductable AC	13 - 14
Aerodynamic Impeller Design	15
Hybrid Ductable Specs.	16
Hybrid Tower Features/ Specs.	17 - 18

### CASSETTE





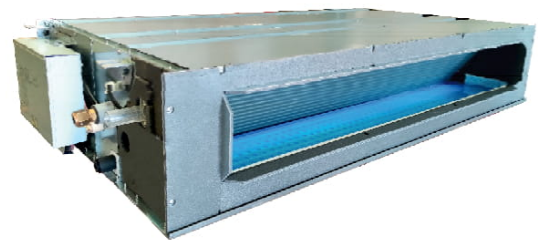



### DUCTABLE

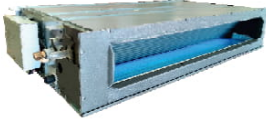

### TOWER



# NON - INVERTER PAC

TYPE	CAPACITY				
	Ton Range	1.5	2.0	3.0	3.7
	KW Range	5.0	7.1	10.5	13.0
 CASSETTE	Indoor	FDT50CNV-S6	FDT71CNV-S6	FDT100CSV-S6	FDT125CSV-S6
	Outdoor	FDC50CNV-S6	FDC71CNV-S6	FDC100CSV-S6	FDC125CSV-S6
 DUCTABLE	Indoor	FDUM50CNV-S6	FDUM71CNV-S6	FDUM100CSV-S6	FDUM125CSV-S6
	Outdoor	FDC50CNV-S6	FDC71CNV-S6	FDC100CSV-S6	FDC125CSV-S6
 TOWER	Indoor	-	FD71CNV-S6	-	FD125CSV-S6
	Outdoor	-	FDC71CNV-S6	-	FDC125CSV-S6
OUTDOOR UNIT					

## Design Condition

Outdoor Temperature

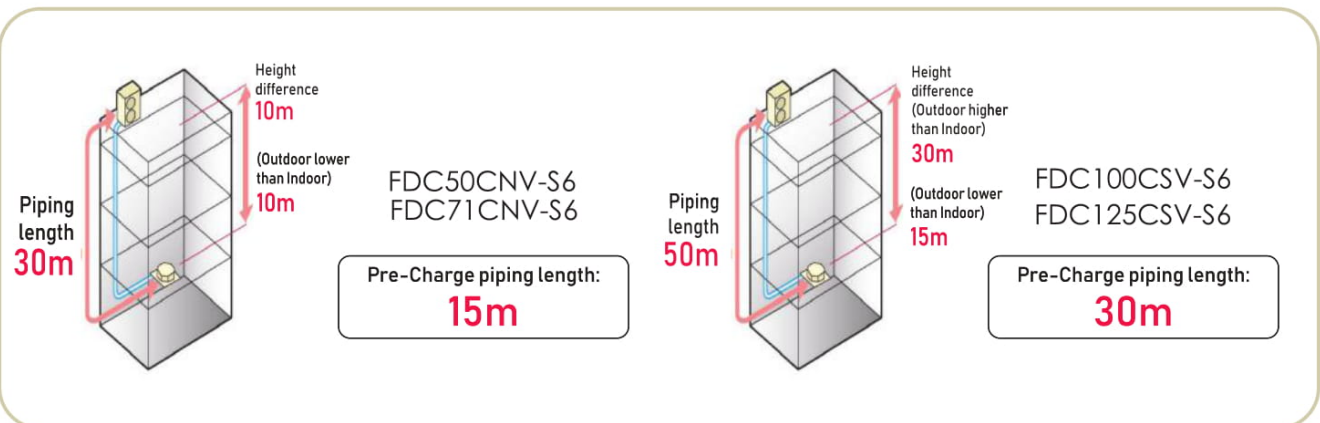
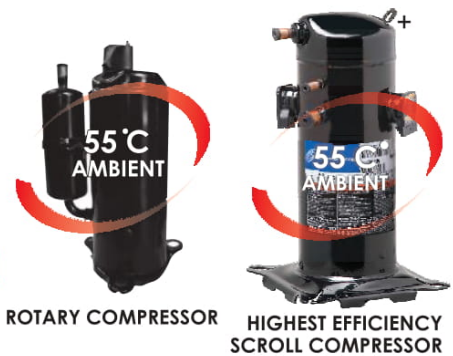
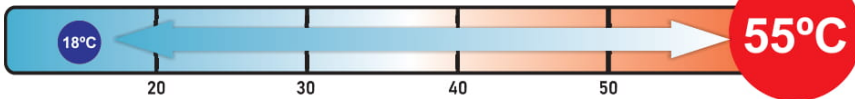



# Features

## ECONOMY MODE



### ENERGY SAVING MODE

Temperature is set to optimize to save energy without losing comfort.

## COMFORT



### Automatic Operation

This function automatically selects the required cooling function based on the current room conditions.

## AIRFLOW



### Individual Flap Control System

Wired remote controller allows you to set the upper and lower limit positions of the flap at each air outlet individually, providing you with complete control over air flow inside the room.



### Vertical Auto Swing

The vertical louvers on your unit will move up and down continuously during operation. This function allows you to set the up/down swing position of the louver to your preferred operation angle.

## TIMER



### Sleep Timer

This function allows you to set a pre-determined amount of time between 30 and 240 minutes that your unit will operate before switching off.



### Motion sensor (optional)

This sensor detects human activity and shifts the temperature setting according to the amount of activity in the room.



### Draft prevention setting (optional)

Draft Prevention setting provides a comfortable air flow without any draft feeling. The remote control can be used to instantly to suppress any warm or cool drafts. This accurately assists how air flow is directed out of the indoor unit.



### Automatic Fan Speed

The unit's on-board microcomputer continuously monitors the room's air temperature and adjusts the air flow automatically.

## CONVENIENT



### Air Filter

The air filter in the unit traps and removes airborne dust particles and other allergens to provide you with a clean air.



### Filter Clean Indicator

This warning alerts you as to when the filter needs to be cleaned.



### Function Switch

From the seven available functions on the unit, this function allows you to set two functions to operate automatically.



### Favorite setting

Operation mode, set temperature, fan speed and air flow direction automatically adjust to the programmed favourite setting.



### Fresh Air Intake Provision

This function provides clean fresh air into the room through the external air intake, avoiding the constant recycling of internal air.

## SERVICE FUNCTION



### Self Diagnostics

The internal microcomputer automatically runs a diagnostic of the system in the event of a malfunction. This enables your authorised dealer to isolate and repair any issues.



### Improved Serviceability



The fan unit (comprised of impeller and motor) is easily accessible from either the side or bottom of the unit and can be slide out for easy maintenance.

















































### Built in Drain Pump

The built-in drain pump, allows greater flexibility with installation, offering a great solution for applications with limited space.

## Indoor Units

When using RC-EX3A (Remote control), functions with symbol  are available. However, for RC-E5 (Remote control), functions  with are not available.

					
Economy	<b>Economy Mode</b> 	<b>ENERGY SAVING MODE</b> Temperature is set to optimized to save energy without losing comfort.			
Comfort	<b>Automatic Operation</b> 	This function automatically selects the required cooling function based on the current room conditions.			
	<b>Motion sensor (optional) *</b> 	This sensor detects human activity and shifts the temperature setting according to the amount of activity in the room.	 Option		
Air flow	<b>Individual Flap Control</b> 	Wired remote controller allows you to set the upper and lower limit positions of the flap at each air outlet individually, providing you with complete control over interior air flow.			
	<b>Draft prevention setting *</b> 	Draft Prevention setting provides a comfortable air flow without any draft feeling. The remote control can be used to instantly suppress any warm or cool drafts. This accurately assists how air flow is directed out of the indoor unit.			
	<b>Vertical Auto Swing</b> 	The vertical louvers on your unit will move up and down continuously during operation. This function allows you to set the up/down swing position of the louver to your preferred operation angle.	 Option		
	<b>Automatic Fan Speed</b> 	The unit's on-board microcomputer continuously monitors the room's air temperature and adjusts the air flow automatically.			
Timer	<b>Sleep Timer</b> 	This function allows you to set a pre-determined amount of time between 30 and 240 minutes that your unit will operate before switching off.			
	<b>Weekly Timer</b> 	Set your unit to turn on and off automatically on a weekly basis to suit your usual room usage on each day.			
Convenient	<b>Function Switch *</b> 	From the seven available functions on the unit, this function allows you to set two functions to operate automatically.			
	<b>Favorite setting *</b> 	Operation mode, set temperature, fan speed and air flow direction automatically adjust to the programmed favorite setting.			
	<b>Select the language *</b> 	Set the language to be displayed on the remote control.			
	<b>Air Filter</b> 	The air filter in the unit traps and removes airborne dust particles and other allergens to provide you with a clean air.		 Option	
	<b>Filter Clean Indicator</b> 	This warning alerts you as to when the filter needs to be cleaned.			
	<b>Outside Air Intake</b> 	This function provides clean fresh air into the room through the external air intake, avoiding the constant recycling of internal air.			
Others	<b>Self Diagnostics</b> 	The internal microcomputer automatically runs a diagnostic of the system in the event of a malfunction. This enables your authorised dealer to isolate and repair any issues.			
	<b>Built in Drain Pump</b> 	The built-in drain pump, allows greater flexibility with installation, offering a great solution for applications with limited space.			
	<b>Improved Serviceability</b> 	The fan unit (comprised of impeller and motor) is easily accessible from either the side or bottom of the unit and can be slid out for easy maintenance.			

FROST PREVENTION FOR HEAT EXCHANGER

INDOOR FAN MOTOR PROTECTION

ABNORMALITY OF OUTDOOR UNIT

DRAIN WATER SPIL PROTECTION

COMPRESSOR OVERHEAT PROTECTION

SIGNAL TRANSMISSION ERROR PROTECTION



SENSOR DISCONNECTION PROTECTION

ROOM TEMPERATURE SENSOR

INDOOR HEAT EXCHANGER TEMPERATURE SENSOR

OUTDOOR HEAT EXCHANGER TEMPERATURE SENSOR

DISCHARGE PIPE TEMPERATURE SENSOR

OUTDOOR AIR TEMPERATURE SENSOR



# HYBRID+ Cassette

Futuristic Design  
Comfort  
Control

## Next Generation

Aerodynamic Vane Design

Draft Prevention Panel

Motion Sensor

Next Generation High Performance Airconditioning  
High energy efficiency with latest technology

## Aerodynamic Super Turbo Fan

CFD (computational fluid dynamics), used in blade shape design of jet engines, has been applied to the design of air channels of the Super Turbo Fan of the Cassette AC to develop the ideal air channels system for air movement. The airflow created in this system by Large Diameter Slim Turbo Fan with WIDE AREA aerodynamic Vanes enables large volumes of air to be blown with minimum power consumption, yet the air flow is uniform, quiet & with longer reach. CFD used in the design of the Super Turbo Fan produces an even laminar air flow to ensure highest air flow at the lowest noise levels. DC motor makes the turbo fan movement energy efficient, vibration free & hum free.

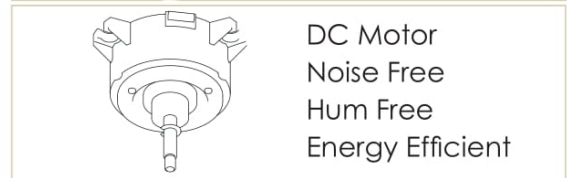
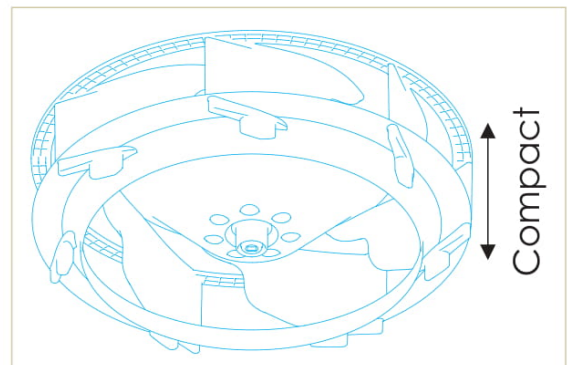

## Aerodynamic Vane Design

Improved Technology for quieter Operation  
Our new design aerodynamic vane blade & Super Turbo Fan Can achieve low noise by reducing the pressure fluctuation in the indoor unit.

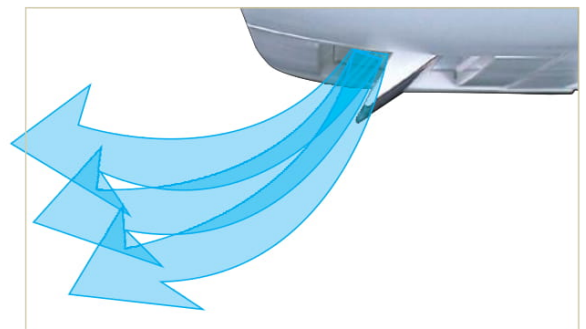



## Draft Prevention Panel

( optional )

**Maximum comfort with minimal draft**  
**New FDT controls flaps with more flexibility**

Draft Prevention Panel Prevents cold draft blown directly on the user. It is possible to set Draft Prevention Panel for each air outlet. User can position Draft Prevention Panel panels by using the remote controller only (RC-EX3A, RCN-T-5AW-E2).

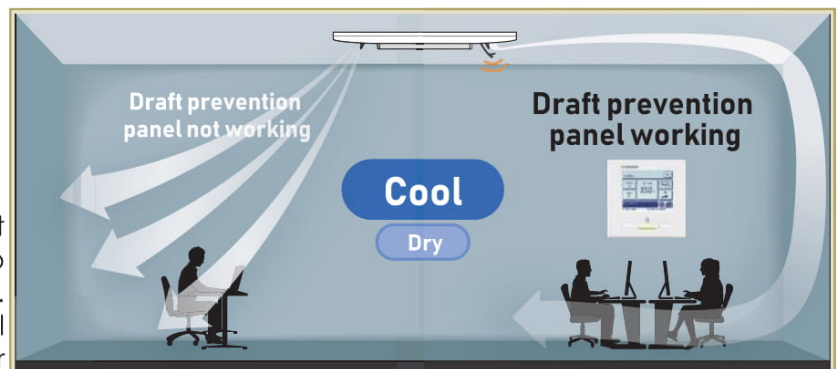

## Motion Sensor

( optional )

Motion sensor is equipped in the panel corner and detects the presence/absence and activity of humans in a room to improve the comfort and energy saving performance of the unit.

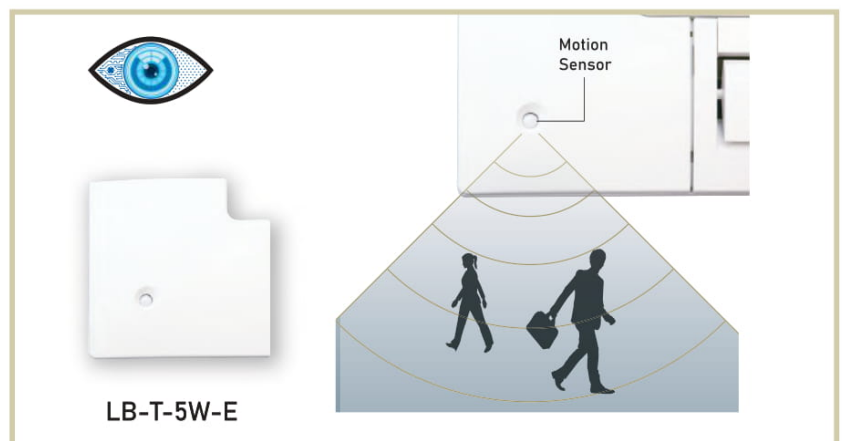



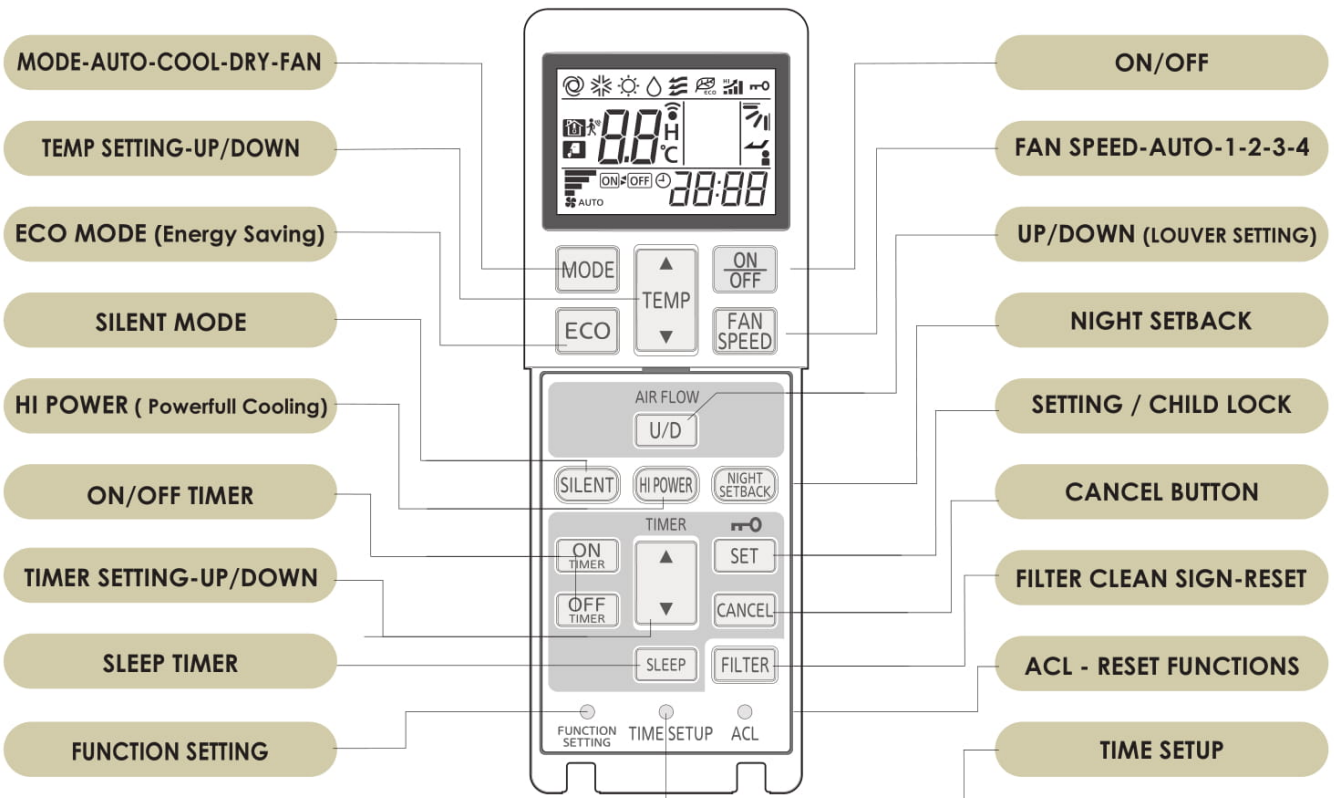
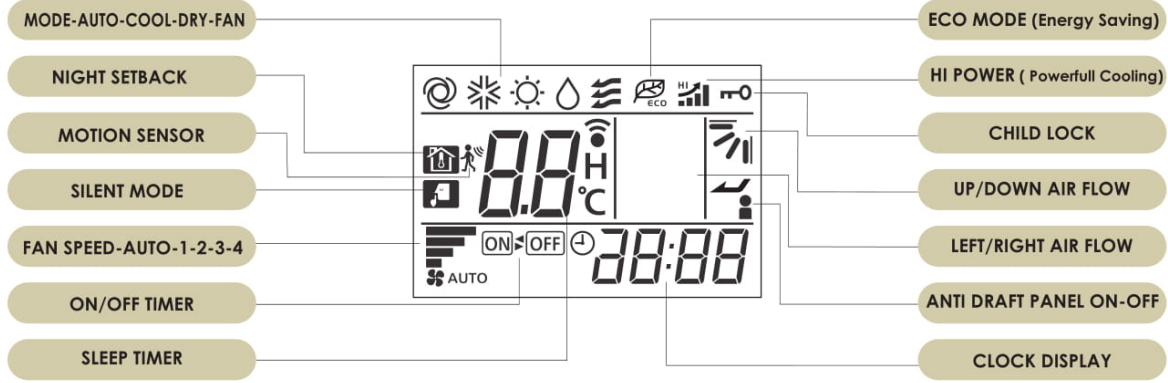

## Motion Sensor Control

Presence of humans and the amount of motion are detected by a motion sensor to perform various controls.

### Select Enable / Disable Motion sensor control



Enable / Disable

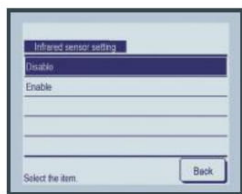

Select Enable / Disable for the motion sensor of the indoor unit connected to the R/C.

### Select Enable / Disable per control

- Power control
- Auto-off



Enable / Disable

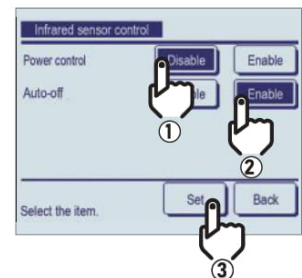

## Contact company & Error display

If any error occurs on the air conditioner, the "Unit protection stop" is indicated on the message display.

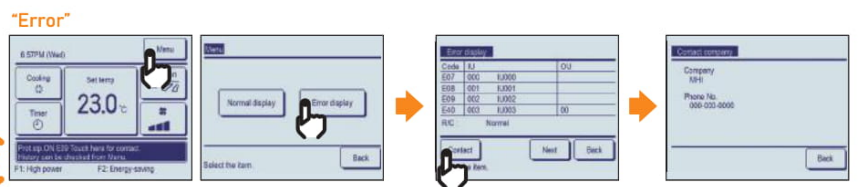



Simple use with advanced settings

## RC-EX3A

### Function Switch

The function switch allows you to select and set two functions that you desire among the seven available functions shown. These functions can be used by simply pressing the button after they are set, allowing you to use your preferable functions immediately.



#### HIGH POWER MODE

High Power Mode achieve excessive cooling / heating capacity for 15 minutes to quickly adjust the room temperature to a comfortable level.



#### ENERGY SAVING MODE

Temperature is set to optimized to save energy without losing comfort.



#### QUIET MODE

Outdoor unit starts to operate quietly by activating this mode. The time of this mode can be set in conjunction with Indoor Silent Timer.



#### HOME LEAVE MODE

Home leave mode maintains the room temperature at a moderate level.



#### FAVOURITE MODE

Operation mode, set temperature, fan speed and air flow direction are automatically adjusted to the programmed favorite setting.



#### FITTER SIGN

Announces the due time for cleaning the air filter.

### Favourite Mode

Operation mode, set temperature, fan speed and air flow direction are memorized and allocated to two buttons that can be operated by one touch.

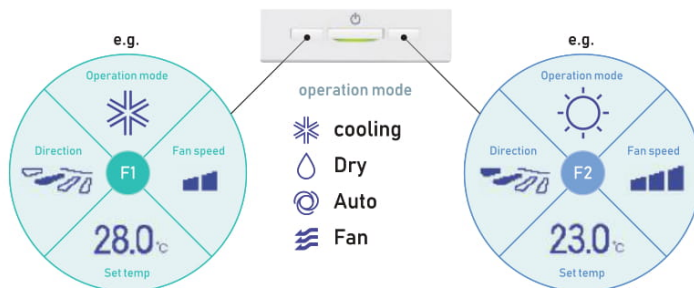

### Adjustable Brightness of the Operation Lamp

The brightness of the operation lamp behind Run/Stop switch can be adjusted by 10 stages.



### Draft Prevention Setting

(only FDT series)

User can enable/disable the motion of panel with anti draft for each operation mode. This function can be set while operating.

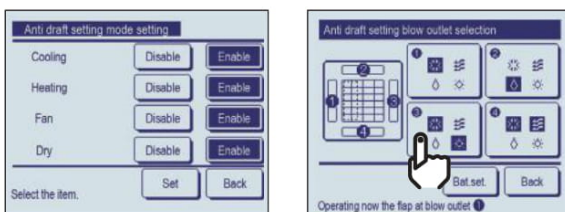

### Easy Modification of Air Flow

User can visually confirm and set the direction of louvres using the visual display on the remote controller.

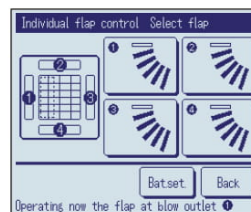

# HYBRID+ Cassette

4 Way

Futuristic Design  
Comfort  
Control!



## REMOTE CONTROL

### Wireless (Standard)



RCN-T-5AW-E2 RCN-E2

### Wired (Optional)



RC-E5



RCH-E3



RC-EX3A

## ECONOMY COMFORT AIRFLOW



Energy Saving



Automatic Operation



Motion sensor (optional)



Automatic Fan



Vertical Auto Swing



Draft Prevention (optional)



Individual Flap Control (Wired Remote)



Self Diagnostics



Sleep Timer



Filter Clean Indicator



Outside Air Intake

## 850mm Drain Pump

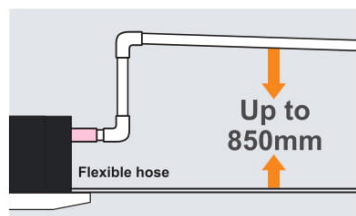

**RCN-E2**  
Standard



# Individual Flap Control System

Wired Controller ( optional )



**RC-E5**



**RC-EX3A**

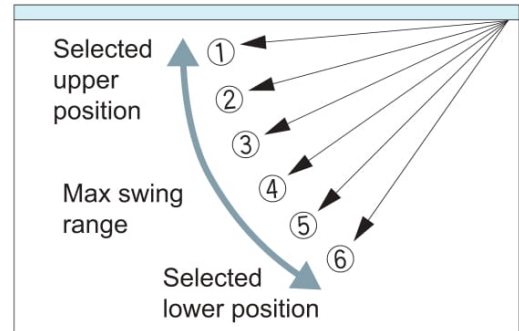

The wireless remote control is not applicable to the Individual flap control system.

According to room conditions, four directions of air flow can be controlled individually by utilizing the flap control system. Individual flap control is available even after installation. Flap can swing within an upper and lower flap range position which can be selected with a wired remote control

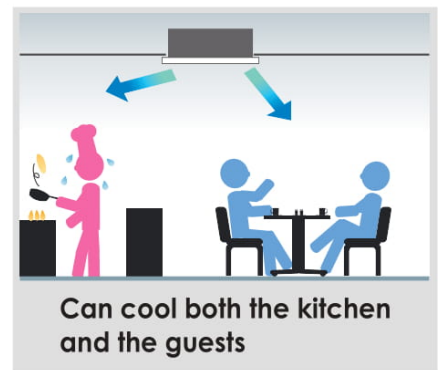
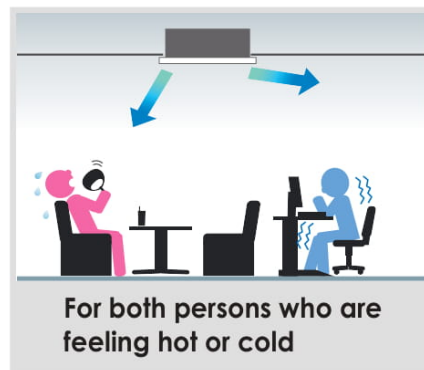
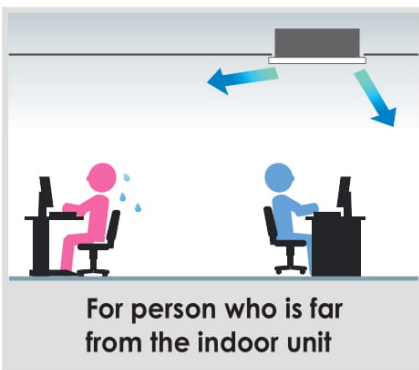
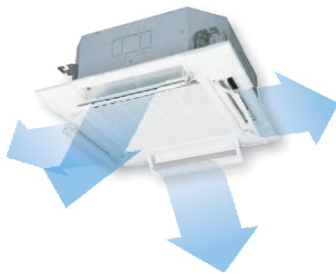

# Draft Prevention Panel ( optional )

Draft Prevention Panel Prevents cold draft blown directly on the user. It is possible to set Draft Prevention Panel for each air outlet. User can position Draft Prevention Panel panels by using the remote controller only(RC-EX3A, RCN-T-5AW-E2).

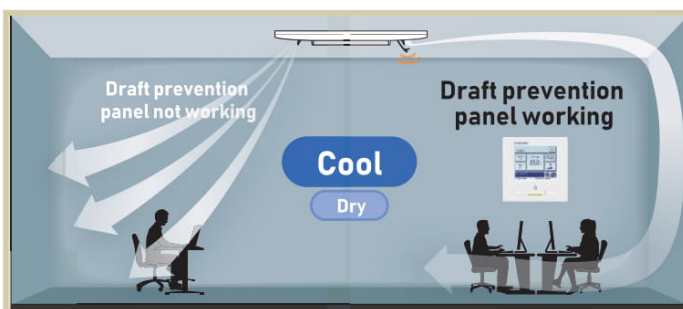

# Motion Sensor ( optional )

Motion sensor is equipped in the panel corner and detects the presence/absence and activity of humans in a room to improve the comfort and energy saving performance of the unit.

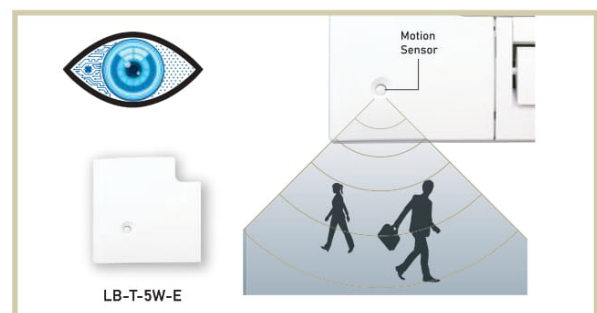

## Compact Height

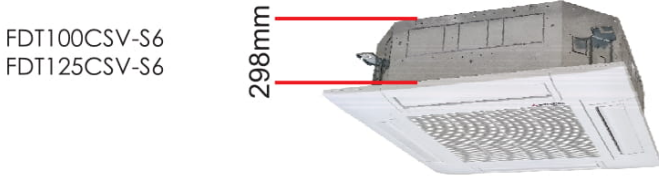

## Suitable for High Ceilings

The Powerful blowout carries comfortable air flow to the floor even in high ceiling applications. It is ideal for high ceiling offices, stores, etc., with a wide, uniform air flow throughout the room.

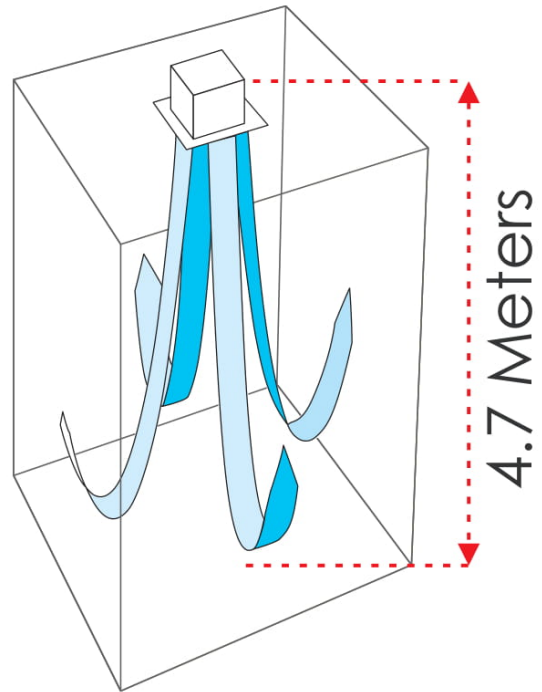

## 850mm Drain Pump

Drain can be discharged upwards up to 850mm from the ceiling surface, allowing a piping layout with a high degree of freedom. Thanks to the 185mm flexible hose, equipment supports easy workability.

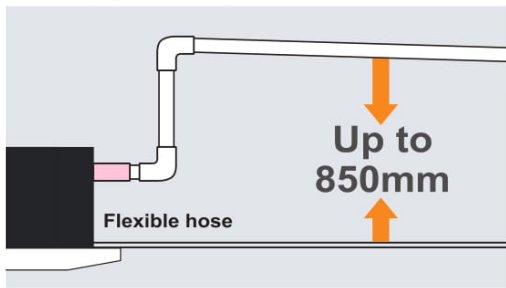

## Panel Select Pattern (optional)

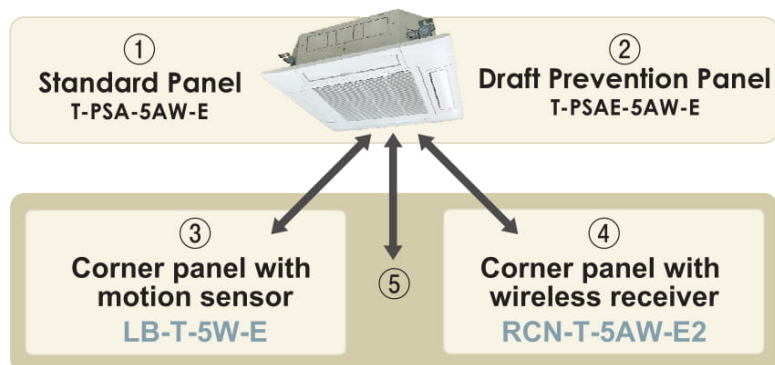

### Installation position of Wireless kit and Motion sensor kit

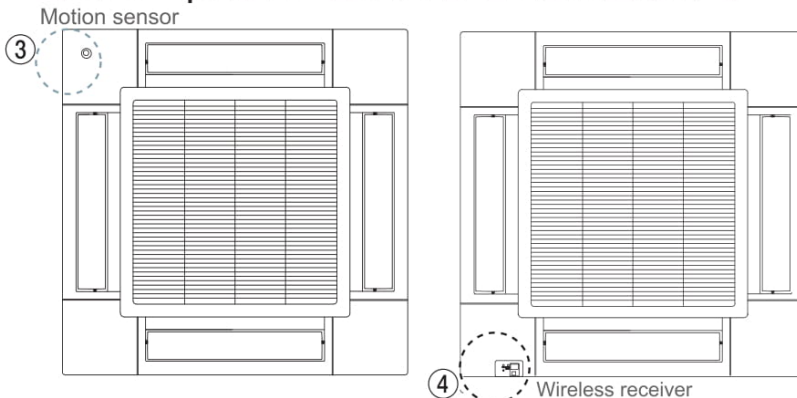

8 patterns of panel are available.

- ① Standard Panel only
- ①+③ Standard Panel with corner panel with motion sensor
- ①+④ Standard Panel with corner panel with wireless receiver
- ①+⑤ Standard Panel with corner panel with motion sensor & corner panel with wireless receiver
- ② Draft Prevention Panel only
- ②+③ Draft Prevention Panel with corner panel with motion sensor
- ②+④ Draft Prevention Panel with corner panel with wireless receiver
- ②+⑤ Draft Prevention Panel with corner panel with motion sensor & corner panel with wireless receiver

\* Wireless receiver and Motion sensor can be installed to the position as shown



# SPECIFICATIONS

SPECIFICATIONS			HYBRID - CEILING CASSETTE - 4WAY (R410A)			
Unit			FDT50CNV-S6	FDT71CNV-S6	FDT100CSV-S6	FDT125CSV-S6
Model	Indoor Unit		FDT50CNV-S6	FDT71CNV-S6	FDT100CSV-S6	FDT125CSV-S6
	Outdoor Unit		FDC50CNV-S6	FDC71CNV-S6	FDC100CSV-S6	FDC125CSV-S6
Super Tropical - Return cooled Compressor			Rotary		Rotary	Scroll
Type of AC			Heavy Duty AC		Hybrid AC	
Power Source			1 Phase, 220 - 240 V, 50 Hz		3 Phase, 380 - 440 V, 50 Hz	
Rated Cooling Capacity	Ton		1.5	2.1	3.0	3.7
	Watts		5000	7300	10400	13000
	BTU/h		17060	24908	35485	44356
Input Power ** (Minimum - Maximum)	watts		1350 - 1550	2000 - 2250	2580 - 2880	3860 - 4160
Rated EER / COP	W/w		3.23	3.24	3.61	3.13
Air flow ( Powerful - Hi )	Indoor Unit	CMH	1280 (P-Hi=1320)	1680 (P-Hi=1920)	2050 (P-Hi=2300)	2200 (P-Hi=2500)
Long Reach Airflow Up to	Indoor Unit	Meter	3.65	4.57	5.18	5.18
Sound Level (Powerful - Hi / H/M/L)	Indoor Unit	dB(A)	39 /38/ 37/ 34	46 / 43 / 39/ 37	44 / 40 / 38 /34	44 / 41 / 39 / 36
Louver Swing	Indoor Unit		Yes (Individual Flap Control System Possible in Wired Controller)			
Remote Control	Indoor Unit		Standard - Wireless Remote Controller Included / Wired Controller Optional			
Self Diagnosis Function	Indoor Unit		Yes			
Filter	Indoor Unit		Anti- Bacterial			
Fan	Indoor Unit		Super Turbo Fan			
DC Fan Motor Speed	Indoor Unit		Powerful - High / High / Medium / Low / Dry			
External Static Pressure E.S.P. (Pascal)#	Indoor Unit	Pa	Not Applicable			
Dimension (H x W x D)	Indoor Unit	mm	Unit : 236 x 840 x 840 Panel : 35 x 950 x 950		Unit : 298 x 840 x 840 Panel : 35 x 950 x 950	
	Outdoor Unit		640 x 800 (+71) x 290		845 x 970 x 370	
Weight	Indoor Unit	Kgs	25.0 (Unit:20 Panel:5.0)	27.0 (Unit:22 Panel:5.0)	30.0 (Unit:25 Panel:5.0)	30.0 (Unit:25 Panel:5.0)
	Outdoor Unit	Kgs	42	46	79	85
Refrigerant			R410A			
Refrigerant Piping	Liquid/ Gas	mm	6.35 ( 1/4" ) / 15.88 ( 5/8" )		9.52 ( 3/8" ) / 15.88 ( 5/8" )	
Precharged Refrigerant		Kgs	1 Kgs (Upto 15mtrs.)	1.4 Kgs (Upto 15mtrs.)	2.15 Kgs (Upto 30mtrs.)	2.65 Kgs (Upto 30mtrs.)
Charging requirement per mtrs		grams	25 grams ( Above 15mtrs upto 30 mtrs )		50 grams ( Above 30mtrs upto 50 mtrs )	
Maximum Piping Length		Mtrs	30 mtrs / 100 feet		50 mtrs / 164 feet	
Vertical Height Difference		Mtrs	Outdoor- Higher =10 mtrs / Lower =10 mtrs		Outdoor - Higher =30 mtrs / Lower =15 mtrs	
Main Power Supply to	Outdoor Unit		2.5 mm <sup>2</sup> x 3 cores ( including earthing )		4 mm <sup>2</sup> x 5 cores ( including earthing )	
Connecting wiring	B/w IDU & ODU		1.5 mm <sup>2</sup> x 4 cores ( including earthing )			
Area Coverage ***		Sq.Meter	15.97 - 18.58	18.58 - 25.54	25.54 - 32.51	32.51 - 44.12

# REFRIGERANT PIPE LENGTH

FDT50CNV-S6 / FDT71CNV-S6

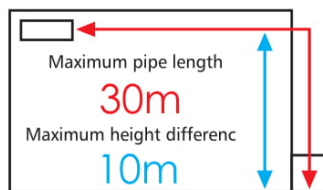

FDT100CSV-S6 / FDT125CSV-S6

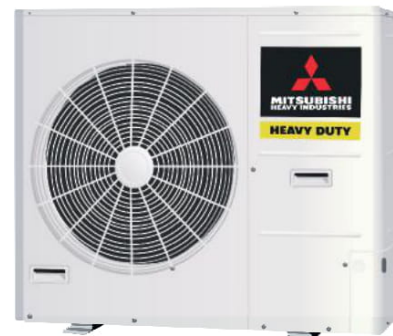
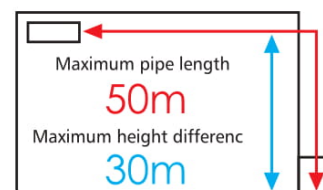

\*\* Under Standard Installation & Lab Test Condition \*\*\* Check for design condition and corresponding parameters like roof / window exposed to direction sunlight, of the area to be Air- conditioned. Because of our policy of continuous improvement, we reserve the right to make changes in all specifications without any prior notice

# HYBRID+ Ductable

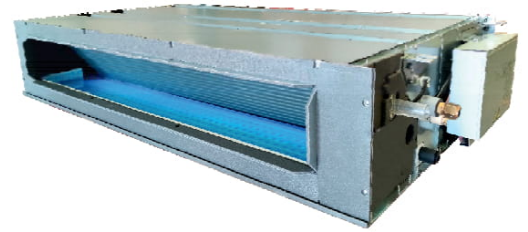

Next Generation

**ECONOMY**

- Energy Saving
- Self Diagnostics

**COMFORT**

- Automatic Operation
- Sleep Timer
- Motion sensor (optional)
- Filter Clean Indicator

**AIRFLOW**

- Automatic Fan
- Outside Air Intake

- SILENT
- 47% Saving Electricity
- EEV

HYBRID AC gives 1.5 times bigger area coverage compared to Conventional AC & still gives electricity saving

## Automatic External Static Pressure (E.S.P.) Control

Optional For Ductable AC Wired Remote Control Model RC-E5 / RC- EX3A  
Duct design was simplified, using DC motor. The most optimum air flow volume can be achieved by this automatic control. Indoor unit will recognize external static pressure by itself automatically and keep rated air flow volume.

The External Static Pressure (E.S.P.) can be manually set on the wired remote controller. It will control the fan speed to keep rated air flow volume at each fan speed setting. You can set required E.S.P. by wired remote controller, calculated with the set air flow rate and the pressure loss of the duct.

### Wireless Remote

**RCN-KIT4-E2**  
Standard

Setting No.	No.1	No.2	No.3	No.4	No.5	No.6	No.7	No.8	No.9	No.10
E.S.P.	10Pa	20Pa	30Pa	40Pa	50Pa	60Pa	70Pa	80Pa	90Pa	100Pa

**Wired (Optional)**

**RC-E5**

**RC-EX3A**

External Static Pressure (E.S.P.) can be set by E.S.P. button.



## Built in Drain Pump

600mm Drain Pump is mounted in all models. The indoor unit is completely hidden in the ceiling, so this is suitable for spaces with classy interior design & false ceiling.

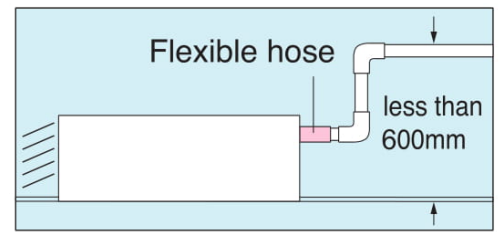

600MM DRAIN PUMP

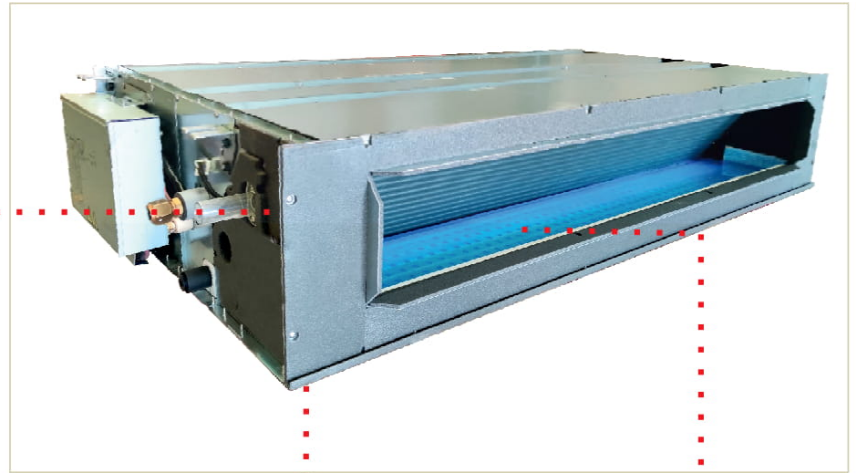
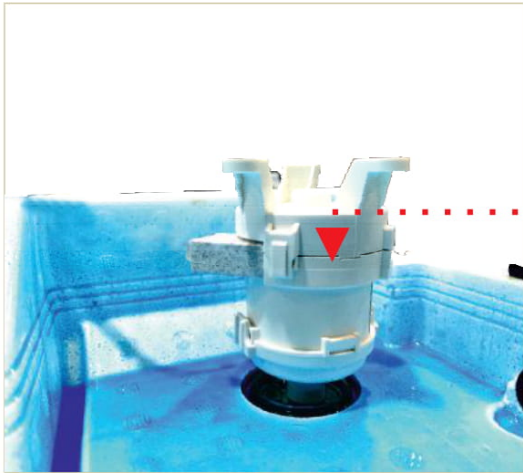

## Transparent Inspection Window

Improvement of the Serviceability  
Dirt condition of the bottom of a drain pan can be checked through this transparent inspection window without removing drain pan.

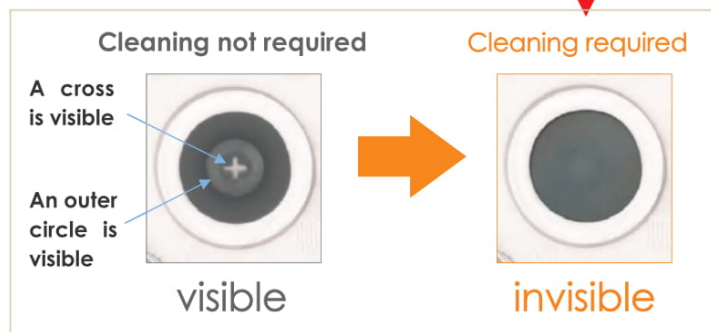

## Drain Tray with Polyurethane Ethoxyline Resin Coating

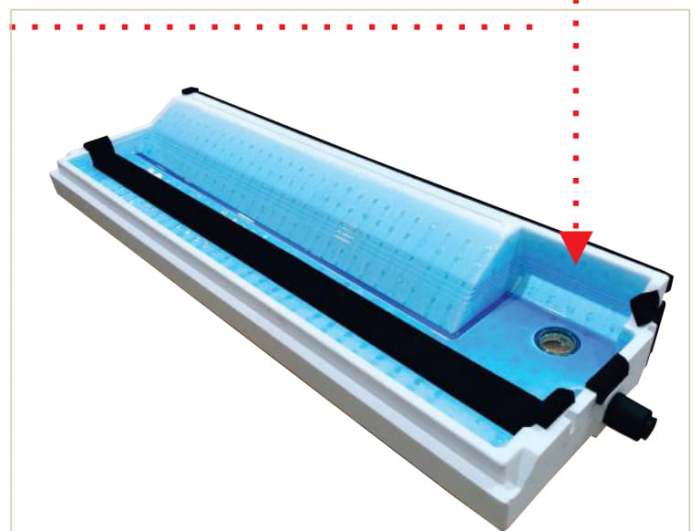

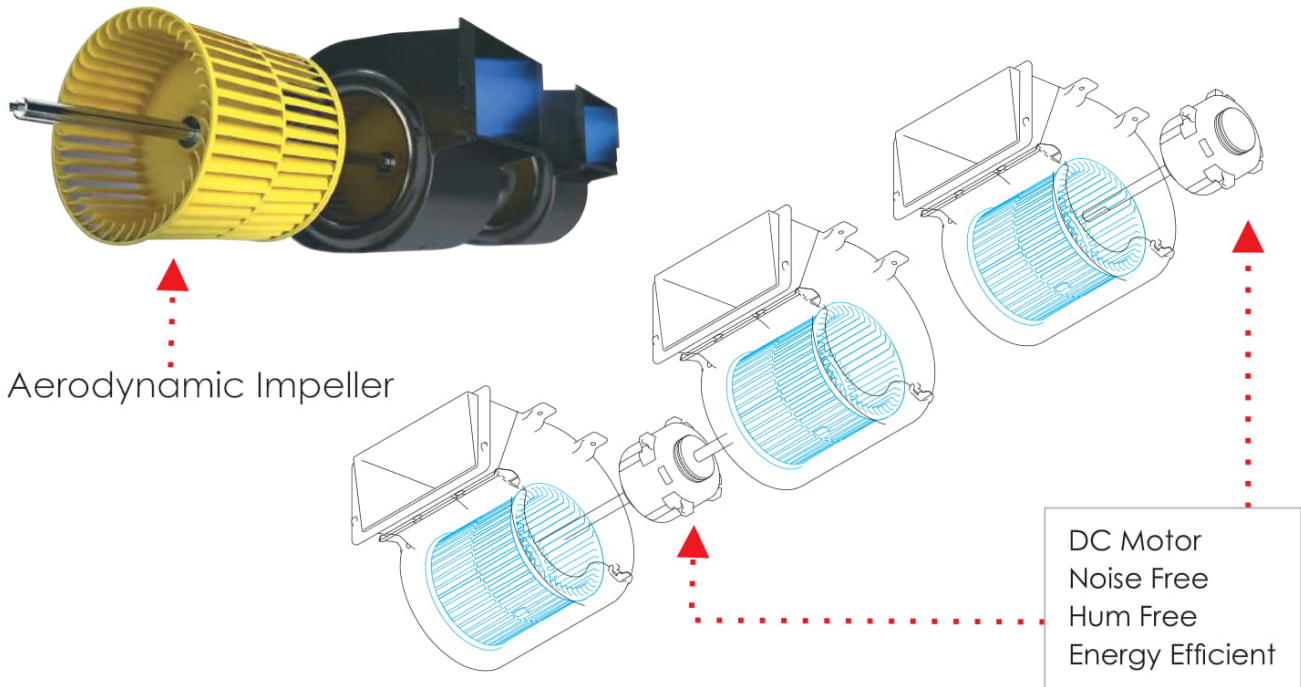

CFD (computational fluid dynamics), used in blade shape design of jet engines, has been applied to the design of air channels in the impeller of the air conditioners to develop the ideal air channels system for air movement. The air flow of the jets created in this system enables a large volume of air to be blown with minimum power consumption, yet the air flow is uniform, quiet and reaches points a long distance from the blower. With CFD used in the design of the impeller, produces an even laminar airflow to ensure the highest air flow & air throw at the lowest noise levels.

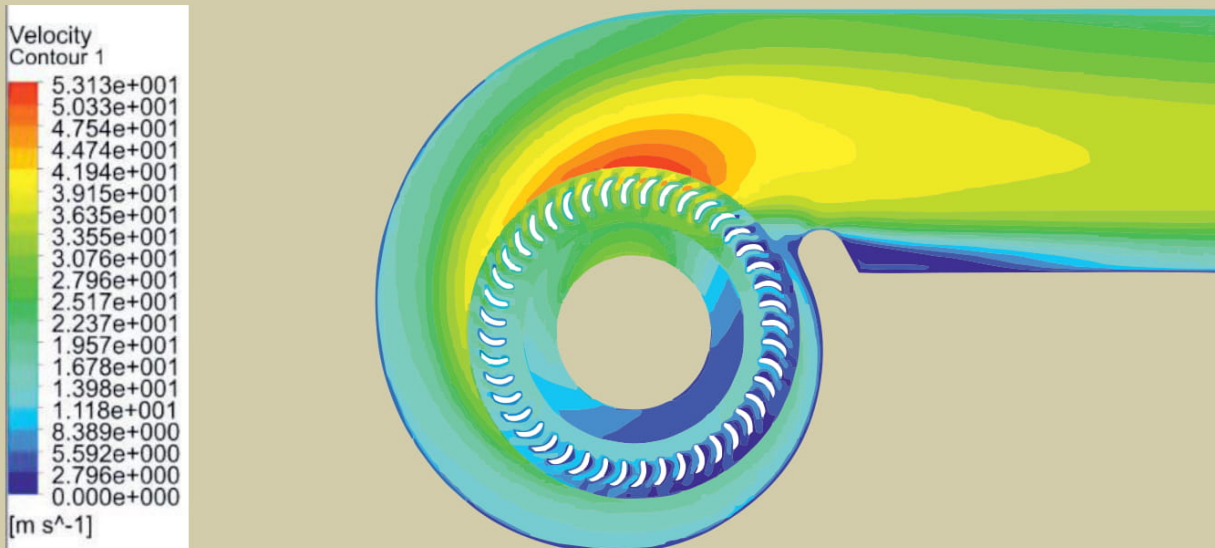



# SPECIFICATIONS

SPECIFICATIONS		HYBRID- DUCTABLE MEDIUM STATIC- FDOM SERIES (R410A)				
Unit		FDUM50CNV-S6	FDUM71CNV-S6	FDUM100CSV-S6	FDUM125CSV-S6	
Model	Indoor Unit	FDUM50CNV-S6	FDUM71CNV-S6	FDUM100CSV-S6	FDUM125CSV-S6	
	Outdoor Unit	FDC50CNV-S6	FDC71CNV-S6	FDC100CSV-S6	FDC125CSV-S6	
Super Tropical - Return cooled Compressor		Rotary		Rotary	Scroll	
Type of AC		Heavy Duty AC		Hybrid AC		
Power Source		1 Phase, 220 - 240 V, 50 Hz		3 Phase, 380 - 440 V, 50 Hz		
Rated Cooling Capacity	Ton	1.5	2.0	3.0	3.7	
	Watts	5000	7100	10400	13000	
	BTU/h	17060	24225	35485	44356	
Input Power ** (Minimum - Maximum)		watts	1400 - 1613	2000 - 2290	2900 - 3100	4000 - 4460
Rated EER / COP		W/w	3.10	3.10	3.10	2.91
Air flow (Powerful - Hi)	Indoor Unit	CMH	600 (P-Hi=800)	1200 (P-Hi=1440)	1950 (P-Hi=2340)	2200 (P-Hi=2880)
Long Reach Airflow Upto	Indoor Unit	Meter	2.43	3.65	6.09	6.09
Sound Level (Powerful - Hi /H/M/L)	Indoor Unit	dB(A)	35 / 31 / 29 / 27	38 / 33 / 31 / 29	42 / 36 / 32 / 29	44 / 37 / 33 / 29
Louver Swing	Indoor Unit		Not Applicable			
Remote Control	Indoor Unit		Standard - Wireless Remote Controller Included / Wired Controller Optional			
Self Diagnosis Function	Indoor Unit		Yes			
Filter	Indoor Unit		Anti- Bacterial Wire Mesh Filter - Optional - Chargeable Extra - Procure Locally			
Fan	Indoor Unit		Centrifugal Blower			
DC Fan Motor Speed	Indoor Unit		Powerful - High / High / Medium / Low / Dry			
External Static Pressure E.S.P. (Pascal) #	Indoor Unit	Pa	Standard = 35 Pa / Max = 100 Pa		Standard = 60 Pa / Max = 100 Pa	
Dimension (H x W x D)	Indoor Unit	mm	280 x 750 x 635	280 x 950 x 635	280 x 1370 x 740	
	Outdoor Unit		640 x 800 (+71) x 290		845 x 970 x 370	
Weight	Indoor Unit	Kgs	34	34	53	53
	Outdoor Unit	Kgs	42	46	79	85
Refrigerant			R410A			
Refrigerant Piping	Liquid/ Gas	mm	6.35 ( 1/4" ) / 15.88 ( 5/8" )		9.52 ( 3/8" ) / 15.88 ( 5/8" )	
Precharged Refrigerant		Kgs	1 Kgs (Upto 15mtrs.)	1.4 Kgs (Upto 15mtrs.)	2.15 Kgs (Upto 30mtrs.)	2.65 Kgs (Upto 30mtrs.)
Charging requirement per mtrs		grams	25 grams ( Above 15mtrs upto 30 mtrs )		50 grams ( Above 30mtrs upto 50 mtrs )	
Maximum Piping Length		Mtrs	30 mtrs / 100 feet		50 mtrs / 164 feet	
Vertical Height Difference		Mtrs	Outdoor - Higher -10 mtrs / Lower=10 mtrs		Outdoor - Higher =30 mtrs / Lower =15 mtrs	
Main Power Supply to	Outdoor Unit		2.5 mm2 x 3 cores (including earthing )		4 mm2 x 5 cores (including earthing)	
Connecting wiring	B/w IDU & ODU		1.5 mm2 x 4 cores ( including earthing )			
Area Coverage ***		Sq.Meter	15.97 - 18.58	18.58 - 25.54	25.54 - 32.51	32.51 - 44.12

## FILTER KIT (OPTIONAL)

Anti- Bacterial Wire Mesh Filter -  
Optional - Chargeable Extra - Procure Locally



## REFRIGERANT PIPE LENGTH

FDUM50CNV-S6 / FDUM71CNV-S6

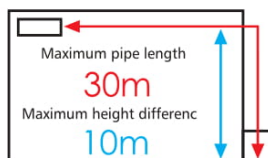

FDUM100CSV-S6 / FDUM125CSV-S6

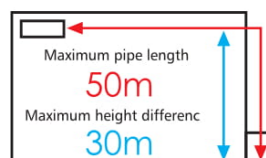

Wireless Remote  
**RCN-KIT4-E2**  
Standard

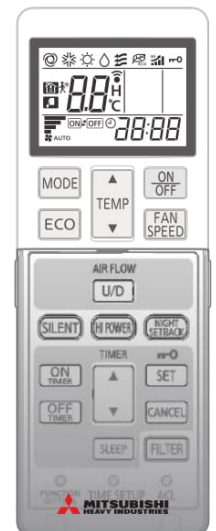

\*\* Under Standard Installation & Lab Test Condition \*\*\* Check for design condition and corresponding parameters like roof / window exposed to direction sunlight, of the area to be Air- conditioned. Because of our policy of continuous improvement, we reserve the right to make changes in all specifications without any prior notice

# [E.S.P. = External Static Pressure can be changed using Wired Controller - Model RC-E5 / RC-EX1A]

# HYBRID+ TOWER



HYBRID AC gives 1.5 times bigger area coverage compared to Conventional AC & still gives electricity saving



# SPECIFICATIONS

SPECIFICATIONS			HYBRID - TOWER AC (R410A)	
Unit			FD71CNV-S6	FD125CSV-S6
Model	Indoor Unit		FD71CNV-S6	FD125CSV-S6
	Outdoor Unit		FDC71CNV-S6	FDC125CSV-S6
Super Tropical - Return cooled Compressor			Rotary	Scroll
Type of AC			Heavy Duty AC	Hybrid AC
Power Source			1 Phase, 220 - 240 V. 50Hz	3 Phase, 380 - 440 V. 50Hz
Rated Cooling Capacity		Ton	2.0	3.70
		Watts	7100	12500
		BTU/h	24225	42650
Input Power ** (Minimum - Maximum)		watts	2300 - 2500	4000 - 4460
Rated EER / COP		W/w	2.84	2.80
Air flow	Indoor Unit	CMH	2250	2700
Long Reach Airflow Upto	Indoor Unit	Meter	9.14	12.19
Sound Level (H/M/L)	Indoor Unit	dB(A)	48 / 40 / 35	51 / 41 / 37
Louver Swing	Indoor Unit		Yes (Vertical)	
Remote Control	Indoor Unit		Standard - Wireless Remote Controller Included + Controller Inbuilt on Indoor unit	
Self Diagnosis Function	Indoor Unit		Yes	
Filter	Indoor Unit		Anti- Bacterial	
Fan	Indoor Unit		Impaler Fan	
DC Fan Motor Speed	Indoor Unit		High / Medium / Low / Dry	
External Static Pressure E.S.P. (Pascal)#	Indoor Unit	Pa	Not Applicable	
Dimension (H x W x D)	Indoor Unit	mm	1850 x 600 x 320	1850 x 600 x 320
	Outdoor Unit		640 x 800 (+71) x 290	845 x 970 x 370
Weight	Indoor Unit	Kgs	51	53
	Outdoor Unit	Kgs	46	85
Refrigerant			R410A	
Refrigerant Piping	Liquid/ Gas	mm	6.35 (1/4") / 15.88 (5/8")	9.52 (3/8") / 15.88 (5/8")
Precharged Refrigerant		Kgs	1.4 Kgs (Upto 15mtrs.)	2.15 Kgs ( Upto 30mtrs.)
Charging requirement per mtrs		grams	25 grams ( Above 15mtrs upto 30 mtrs )	50 grams ( Above 30mtrs upto 50 mtrs )
Maximum Piping Length		Mtrs	30 mtrs / 100 feet	50 mtrs / 164 feet
Vertical Height Difference		Mtrs	Outdoor- Higher= 10 mtrs / Lower= 10 mtrs	Outdoor- Higher- 30 mtrs / Lower= 15mtrs
Main Power Supply to	Outdoor Unit		2.5 mm <sup>2</sup> x 3 cores ( including earthing )	4 mm <sup>2</sup> x 5 cores ( including earthing )
Connecting wiring	B/w IDU & ODU		1.5 mm <sup>2</sup> x 4 cores ( including earthing )	
Area Coverage ***		Sq.Meter	18.58 - 27.87	37.16 - 46.45

## REFRIGERANT PIPE LENGTH

Wireless Remote Standard

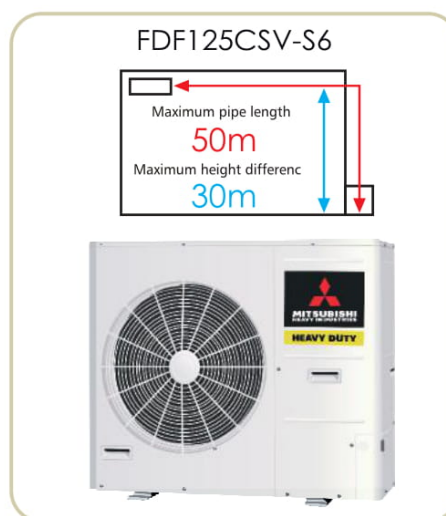
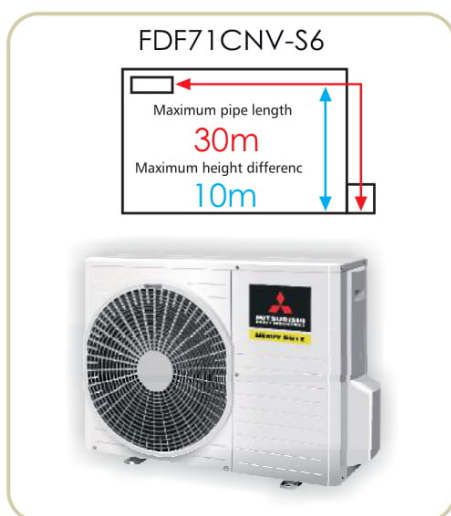

\*\* Under Standard Installation & Lab Test Condition \*\*\* Check for design condition and corresponding parameters like roof / window exposed to direction sunlight, of the area to be Air- conditioned. Because of our policy of continuous improvement, we reserve the right to make changes in all specifications without any prior notice



Our Motto  
"Customer Satisfaction Index No.-1"



Towards A Better Future Together

## PRECAUTIONS

Always get the Mitsubishi Heavy Ind. Airconditioners installed by Authorized Mitsubishi Heavy Ind. Sales & Service Channel Partners only. Do not try to install the AC either by yourself or any unauthorized dealer. Improper installation can result into non performance, low cooling, refrigerant leakage, electrical shocks. Warranty of the product shall be null & void, if not installed by an authorized Mitsubishi Heavy Ind. Sales & Service Channel Partner. In no case it will be company's responsibility if the AC unit is installed by an unauthorized dealer, is unable to perform. Warranty of the AC unit component shall be null & void if non specified/non genuine spares are used or repaired by an unauthorized dealer. Because of our policy of continuous improvement, we reserve the right to make changes in all specifications without notice. In case of any adverse area to be conditioned, if it is not verified by the company/dealer engineer and selection of the AC unit is made by the customer based on the specifications without taking any prior advice, then company will not be responsible for any variance in the performance of the AC unit installed.

Mitsubishi Heavy Industries- Mahajak Air Conditioners Co.Ltd. Lat krabang Industries Estate, Phase 3, 200 Moo 4, Chalongkrung Road, Lamplatiew, Lat krabang, Bangkok Thailand 10520

Sales, Service & Marketing Headquarter (India)



IAPL GROUP

IAPL House, 2/8, West Patel Nagar  
Near Patel Nagar Metro Station- New Delhi- 110008 (INDIA)  
Tel.: 011-47230000-99, Toll Free No.: 1800 102 0055  
Email: info@iaplgroup.com, Website: www.iaplgroup.com

## Sales, Service Office

**AGRA** : 7290094935/8006003003, **AHMEDABAD** : 9978991675, **ANAND** : 7290011957, **BANGALORE** : 9849102323, **BIHAR** : 8588864471, **BHOPAL** : 9630098716, **BHUBANESWAR** : 8697706531, **CHENNAI** : 8939991872, **COCHIN** : 9946446067, **COIMBATORE** : 9645134000, **DEHRADUN** : 8826899163, **DELHI & NCR** : 8826392381, **DELHI** : 8826392374, **GHAZIABAD** : 8826899163, **GWALIOR** : 9630098716, **HARYANA** : 7290094933 / 8929602345, **HYDRABAD** : 9885651712, **INDORE** : 9630033341, **J & K** : 9915009212 / 9599656801, **JABALPUR** : 9630098716, **JAIPUR** : 8588830502, **KOLKATA** : 8697744670, **LUCKNOW** : 8929602483, **LUDHIANA** : 8283843670 / 9599656893, **MUMBAI** : 8879599905, **NAGPUR** : 9657004567, **NASIK** : 7291972089, **NOIDA** : 8826899163, **PATNA** : 8588864471, **PUNE** : 7291972089, **PUNJAB** : 9915009212 / 9599656801, **RAIPUR** : 9821197915, **RAJKOT** : 9727731456, **SURAT** : 9978996351, **THRISSUR** : 9946446067, **TRICHY** : 8929602485, **VADODARA** : 9978991675, **VIJAYAWADA** : 9550488000



(Wholly-owned subsidiary of MITSUBISHI HEAVY INDUSTRIES, LTD.)



Our factories are ISO9001 and ISO14001 certified.

Certified ISO 9001

Certified ISO 14001



BIWAJIMA PLANT  
Mitsubishi Heavy Industries, Ltd.  
Manufacturing Department, Japan

BIWAJIMA PLANT  
Mitsubishi Heavy Industries, Ltd.  
Manufacturing Department, Japan

MITSUBISHI HEAVY INDUSTRIES  
MAHAKAJ AIR CONDITIONERS CO., LTD.  
Certificate Number: 8015 189 9013

MITSUBISHI HEAVY INDUSTRIES  
MAHAKAJ AIR CONDITIONERS CO., LTD.  
Certificate Number: 8014 189 9013