

# COOKING BY ECO MODE

ECO mode is heat by bottom and ring heater, with this mode you can save energy during cooking.

## RECIPES

Accessories	Level	Time(min)	Pre-heat		
Challah	1 tray	180	1	45-50	No
Pork Roast	1 tray	200	1	80-85	No
Clafouti Cherry Cake	Round form	200	1	55-60	No
Beef Roast 1.5kg	1 tray	200	1	80-85	No
Brownies	Rack and glass plate	180	1	55-60	No
Potato Graftin	Rack and round plate	180	1	65-70	No
Lasagne	Rack and glass plate	180	1	75-80	No
Cheese Cake	Springform Ø20cm	160	1	80-90	No

## DATASHEET (EU 65/2014 & EU 66/2014)

Midea EPBI 1167 MTC BK

No. of Cavities	1
Heat Source	Electric
Usable Volume	80L
EC electric, cavity (Conventional)	1.06kWh/cycle
EC electric, cavity (Forced Air)	0.69kWh/cycle
EELCavity	81,9
Energy Efficiency Class (A+++ to D)	A+





EPBI 1167 MTC BK

Built-In Electric Oven

User Manual

## TEST FOOD ACCORDING TO EN 60350-1

RECIPESA	Accessories	F	°C	Level	Time(min)	Pre-heat
Toast	Rack		Max	5	6-8	Yes 5min
Chicken	Rack & tray		180	Rack 2 Tray 1	75-80	Yes

1. In chicken recipe, begin with the backside on top and turn the chicken after 30 min to the top side.
2. Use a dark, frosted mold and place it on the rack.
3. Take out the trays at the moment, when the food is ready, even when it is not at the end of the given baking time.
4. Choose the lower temperature and check after the shortest time, given in the table.
5. If using the tray to capture fluids dripping from the food placed on the rack during any grilling mode, the tray should be set to level 1 and filled with some water.
6. The burger patties should turned around after 2/3 of the time.

## ENERGY EFFICIENCY ACCORDING TO EN 60350-1

Please note the following information:

1. The measurement is carried out in the "ECO" mode to determine the data regarding the forced air mode and the label-class.
2. The measurement is carried out in the "Top & Bottom Heating" mode to determine the data regarding the conventional mode.
3. During the measurement only the necessary accessory is in the cavity. All other parts have to be removed.
4. The oven is installed as described in the installation guide and placed in the middle of the cabinet.
5. It is necessary for the measurement to close the door like in the household, even when the cable disturbs the sealing function of the gasket during the measurement. To make sure, that there are no negative effects regarding the disturbed sealing due to the energy data, it is necessary to close the door carefully during the measurement. It is may be required to use a tool to guaranty the sealing of the gasket like in the household, where no cable disturbs the sealing function.
6. The determination of the cavity volume carried out for the usage "Defrost" as described on page 12. To ensure an efficient use of the oven, all accessories including side-racks are removed.

MEAT	Form	Level	Mode	Temp.in °C	Duration in minutes
Meatloaf 1 kg Meat	Tray	1	Conventional	180	75
Chicken 1 kg	Tray	L2:Rack L1:Tray	Double Grill with Fan	180	50
Fish (2,5 kg )	Tray	2	Conventional	170	70
Ribs Tomahawk Cooked B.T.	Tray	3	Convection	120	85
Pork Roast of the neck (1,2kg )	Tray	1	Convection	160	82
Chicken 1,7kg	Tray	L2:Rack L1:Tray	Convection	180	78

## TEST FOOD ACCORDING TO EN 60350-1

RECIPESA	Accessories	F	C	Level	Time(min)	Pre-heat
Sponge cake	Springform Φ26cm	☐	☐	1	30-35	No
Sponge cake	Springform Φ26cm	☐	☐	1	30-35	No
Small cake	1 tray	☐	☐	2	30-40	Yes
Small cake	1 tray	☐	☐	2	40-50	Yes
Small cake	2 trays	☐	☐	L2&L4	30-35	Yes
Cheese cake	Springform Φ26cm	☐	☐	1	70-80	No
Apple pie	Springform Φ20cm	☐	☐	1	80-85	No
Apple pie	Springform Φ20cm	☐	☐	1	70-80	No
Bread	1 tray	☐	☐	1	30-35	Yes
Bread	1 tray	☐	☐	1	30-35	Yes

# CONTENTS

- 2 SAFETY INFOR
- 3 Intended Use
- 3 Warning
- 6 Causes of damage
- 8 INSTALLATION
- 9 OPERATING THE APPLIANCE
- 9 Identifying the appliance
- 9 EPB1 1187 MTC BK
- 9 Component
- 10 Before using the appliance
- 11 Types of heating
- 12 Using your appliance
- 14 Demo with sabbat mode
- 15 ACCESSORIES
- 19 AIR SAFEGUARD SYSTEM
- 20 ENERGY EFFICIENT USE
- 21 ENVIRONMENT
- 21 HEALTH
- 21 MAINTENANCE YOUR APPLIANCE
- 24 APPLIANCE DOOR
- 31 CURE YOUR APPLIANCE WHEN NEEDED
- 35 CUSTOMER SERVICE
- 36 TIPS AND TRICKS
- 38 TYPICAL RECIPES
- 38 Cakes
- 39 Bread & pizza
- 40 Meat
- 40 TEST FOOD ACCORDING TO EN 60350-1
- 41 ENERGY EFFICIENCY ACCORDING TO EN 60350-1
- 42 COOKING BY ECO MODE
- 42 DATASHEET (EU 65/2014 & EU 66/2014)

## SAFETY INFORMATION

### Intended Use

Thank you for buying Midea Built-in Oven. Before unpacking it, please read these instructions carefully. Only then will you be able to operate your appliance safely and correctly. Warmly recommend retain the instruction manual and installation instructions for future use or for subsequent owners.

The appliance is only intended to be fitted in a kitchen. Observe the special installation instructions.

Check the appliance if there is any damage after unpacking it. Do not connect the appliance if it has been damaged. Only a licensed professional may connect appliances without plugs. Damage caused by incorrect connection is not covered under warranty. Only use this appliance indoors. The appliance must only be used for the preparation of food and drink. The appliance must be supervised during operation. This appliance may be used by children over the age of 8 and by persons with reduced physical, sensory or mental capabilities or by persons with a lack of experience or knowledge if they are supervised or are instructed by a person responsible for their safety how to use the appliance safely and have understood the associated hazards.

Children must not play with, on, or around the appliance. Children must not clean the appliance or carry out general maintenance unless they are at least 8 years old and are being supervised.

Keep children below the age of 8 years old at a safe distance from the appliance and power cable. And please always slide accessories into the cavity the right way round.

CAKE	Form	Level	Mode	Temp.in °C	Duration in minutes
Small Cakes 20	Tray	2	Convection	150	36
Small Cakes 40	Tray	2+4	Convection	150	p.h.t.:10:00 b.t.:34:00
Butter Yeast Cake	Tray	2	Conventional	150	p.h.t.: 8:00 b.t.: 30:00
Shortbread	Tray	2	Conventional	170	p.h.t.: 8:00 b.t.: 13:00
Shortbread 2 Trays	Tray	2+4	Conventional with Fan	160	p.h.t.:8:20 b.t.:12:00
Vanilla Cookies	Tray	2	Conventional	160	p.h.t.: 8:00 b.t.:10:00
Vanilla Cookies	Tray	2+4	Conventional with Fan	150	p.h.t.:8:00 b.t.:14:00
<b>BREAD</b>					
White Bread (1 kg Flour) Box shape	Box	1	Conventional	170	p.h.t.: 9:20 b.t.: 50:00
White Bread (1 kg Flour) Box shape	Box	1	Conventional with Fan	170	p.h.t.: 12:00 b.t.: 45:00
Fresh Pizza (thin)	Tray	2	Conventional	170	p.h.t.: 9:30 b.t.: 21:00
Fresh Pizza (thick)	Tray	2	Conventional	170	p.h.t.: 10:00 b.t.: 45:00
Fresh Pizza (thick)	Tray	2	Conventional with Fan	170	p.h.t.:8:00 b.t.: 41:00
Bread	Tray	1	Convection	190	p.h.t.:9:00 b.t.:30:00

Note : p.h.t means preheat time, b.t. means baking time.

quantities of drinks with high alcohol content. Only use small quantities of drinks with high alcohol content. Open the appliance door with care.

**Risk of scalding!**

1. The accessible parts become hot during operation. Never touch the hot parts. Keep children at a safe distance.
2. When you open the appliance door, hot steam can escape. Steam may not be visible, depending on its temperature. When opening, do not stand too close to the appliance. Open the appliance door carefully. Keep children away.
3. Water in a hot cavity may create hot steam. Never pour water into the hot cavity.

**Risk of injury!**

1. Scratched glass in the appliance door may develop into a crack. Do not use a glass scraper, sharp or abrasive cleaning aids or detergents.
2. The hinges on the appliance door move when opening and closing the door, and you may be trapped. Keep your hands away from the hinges.

**Risk of fire!**

1. Combustible items stored in the cavity may catch fire. Never store combustible items in the cavity. Never open the appliance door if there is smoke inside. Switch off the

Which kind of baking ware can be used?	Every heat resistant baking ware can be used. It is recommended not to use aluminium in direct contact with food, especially when it is sour. Please ensure a good fitting between container and lid.
How to use the grill function?	Preheat the oven for 5 minutes and place the food in the level given by this manual. Close the oven door when you use any grilling mode. Do not use the oven when the door is open, except for load / remove / check the food.
How to keep clean the oven during grilling ?	Use the tray filled with 2 liter of water in at level 1. Nearly all fluids drip down from the food placed on the rack will captured by the tray.
The heating element in all grilling modes are switching on and off over the time.	It is a normal operation and depends on the temperature setting.
How to calculate the oven settings, when the weight of a roast is not given by a recipe?	Choose the settings next to the roast weight and change the time slightly. Use a meat probe if possible to detect the temperature inside the meat. Place the head of the meat probe carefully in the meat, due to the manufacturer instructions. Make sure, that the head of the probe is placed in the middle of the biggest part of the meat, but not in the near of a bone or hole.
What happens if a fluid is poured to a food in the oven during the baking or cooking process?	The fluid will boil and steam will arise as a normal physical process. Please be careful, because the steam is hot. See also "Condensing water during baking" for more information. If the fluid contains alcohol, the boiling process will be quicker and can lead to flames in the cavity. Make sure, that the oven door is closed during such kind of processes. Please control the baking or cooking process carefully. Open the door very gentle and only if necessary.

## TYPICAL RECIPES

CAKE	Form	Level	Mode	Temp./In °C	Duration In minutes
Sponge Cake (simple) in a Box shape	Box	2	Conventional with Fan	170	50
Sponge Cake (simple) in a Box shape	Box	1	Conventional	140	70
Sponge Cake with Fruits in a round Form	Round form	1	Conventional with Fan	150	50
Sponge Cake with Fruits on a Tray	Tray	1	Conventional	140	70
Raisins Brioche Muffins (Yeast Cake)	Muffin form	2	Conventional	220	p.h.t.:19:00 b.t.: 11:00
Gugelhupf (with Yeast)	Tray	1	Conventional	150	p.h.t.:11:00 b.t.:60:00
Muffins	Muffin form	1	Conventional	160	p.h.t.: 8:30 b.t.: 30:00
Muffins	Muffin form	1	Conventional with Fan	150	p.h.t.: 8:30 b.t.: 30:00
Apple Yeast Cake on a Tray	Tray	1	Conventional with Fan	160	p.h.t.: 10:00 b.t.: 42:30
Water Sponge Cake ( 6 Eggs)	Spring form	1	Conventional	160	p.h.t.: 9:30 b.t.: 41:00
Water Sponge Cake ( 4 Eggs)	Spring form	1	Conventional	160	p.h.t.: 9:00 b.t.: 26:00
Water sponge Cake	Spring form	1	Convention	160	35
Apple Yeast Cake on a Tray	Tray	2	Conventional with Fan	150	p.h.t.: 8:00 b.t.: 42:00
Hefezopf (Callah)	Tray	2	Conventional with Fan	150	40

### WARNING

#### Risk of electric shock!

1. Incorrect repairs are dangerous. Repairs may only be carried out and damaged power cables replaced by one of our trained after-sales technicians. If the appliance is defective, unplug the appliance from the mains or switch off the circuit breaker in the fuse box. Contact the after-sales service.
2. The cable insulation on electrical appliances may melt when touching hot parts of the appliance. Never bring electrical appliance cables into contact with hot parts of the appliance.
3. Do not use any highpressure cleaners or steam cleaners, which can result in an electric shock.
4. A defective appliance may cause electric shock. Never switch on a defective appliance. Unplug the appliance from the mains or switch off the circuit breaker in the fuse box. Contact the after-sales service.

#### Risk of burns!

1. The appliance becomes very hot. Never touch the interior surfaces of the appliance or the heating elements.
2. Always allow the appliance to cool down.
3. Keep children at a safe distance.
4. Accessories and ovenware become very hot. Always use oven gloves to remove accessories or ovenware from the cavity.
5. Alcoholic vapors may catch fire in the hot cooking compartment. Never prepare food containing large

## TIPS AND TRICKS

<p>Do not use settings of similar recipes first and compare later recipes.</p> <p>Do not use settings of similar recipes first and compare later recipes.</p>	<p>Try to use settings of similar recipes first and compare the cooking process due to the result.</p> <p>Put a wooden stick inside the cake about 10 minutes before the given baking time is reached. If there is no raw dough at the stick after pulling out, the cake is ready.</p>
<p>The cake comes together better during cooling down after baking.</p>	<p>Try to cover the temperature setting by 10°C and double check the food preparing instructions regarding the mechanical handling of the dough.</p>
<p>The height of the cake is higher when using higher heat at the outer ring.</p>	<p>Do not press the outer ring of the spring form.</p>
<p>The cake is not browned at the top.</p>	<p>Use a lower shelf level and/or use a lower set temperature (this may lead to a longer cooking time).</p>
<p>The cake is too dry.</p>	<p>Use a 10°C higher set temperature (this may lead to a shorter cooking time).</p>
<p>The bread is just cooking but the crumbly inside is missing.</p>	<p>Use a 10°C lower set temperature (this may lead to a longer cooking time) and double check the recipe.</p>
<p>The baking is uneven.</p>	<p>Use a 10°C lower set temperature (this may lead to a longer cooking time).</p> <p>Use the "Top &amp; Bottom Heating" mode on one level.</p>
<p>The cake is not browned on the bottom.</p>	<p>Choose a level down.</p>
<p>Baking on more than one level at the same time. One shelf is better than the other.</p>	<p>Use a fan assisted mode for baking at more than one level and take out the trays individually when ready. It is not necessary that all trays are ready at the same time.</p>
<p>Condensing water during baking.</p>	<p>Steam is part of baking and cooling and moves normally out of the oven together with the cooling air flow. This steam may condense at different surfaces at the oven or near to the oven and build water droplets. This is a physical process and cannot be avoided completely.</p>

appliance and unplugging it from the mains or switch off the circuit breaker in the fuse box.

2. A draught is created when the appliance door is opened. Greaseproof paper may come into contact with the heating element and catch fire. Do not place greaseproof paper loosely over accessories during preheating. Always weight down the greaseproof paper with a dish or a baking tin. Only cover the surface required with greaseproof paper. Greaseproof paper must not protrude over the accessories.

### Hazard due to magnetism!

Permanent magnets are used in the control panel or in the control elements. They may affect electronic implants, e.g. heart pacemakers or insulin pumps. Wearers of electronic implants must stay at least 10 cm away from the control panel.

## Causes of Damage

1. Accessories, foil, greaseproof paper or ovenware on the cavity floor: do not place accessories on the cavity floor. Do not cover the cavity floor with any sort of foil or greaseproof paper. Do not place ovenware on the cavity floor if a temperature of over 50 °C has been set. This will cause heat to accumulate. The enamel will be damaged.
2. Aluminum foil: Aluminum foil in the cavity must not come into contact with the door glass. This could cause permanent discoloration of the door glass.
3. Silicone pans: Do not use any silicone pans, or any mats, covers or accessories that contain silicone. The oven sensor may be damaged.
4. Water in a hot cooking compartment: do not pour water into the cavity when it is hot. This will cause steam. The temperature change can cause damage to the enamel.
5. Moisture in the cavity: Over an extended period of time, moisture in the cavity may lead to corrosion. Allow the appliance to dry after use. Do not keep moist food in the closed cavity for extended periods of time. Do not store food in the cavity.
6. Cooling with the appliance door open: Following operation at high temperatures, only allow the appliance to cool down with the door closed. Do not trap anything in the appliance door. Even if the door is only left open a crack, the front of nearby furniture may become damaged over

## CUSTOMER SERVICE

Our after-sales service is there for you if your appliance needs to be repaired. We will always find an appropriate solution. Please contact the dealer where you bought this appliance. When calling us, please give the model number and S/N so that we can provide you with the correct advice. The rating plate bearing these numbers can be found when you open the appliance door.

Model: EPE1167 MTC BK  
Rated voltage: 220-240V-  
Rated frequency: 50Hz-60Hz  
Electric power: 2.9 kW



To save time, you can make a note of the model of your appliance and the telephone number of the aftersales service in the space below, should it be required.

### MAINTENANCE CARD

Model number	Purchasing date
Serial number	Purchasing store

#### Warning

This appliance shall be installed in accordance with the regulations in force and only used in a well ventilated space. Read the instructions before installing or using this appliance.

#### Note

Please note that a visit from an after-sales service engineer is not free of charge, even during the warranty period. Rely on the professionalism of the manufacturer. You can therefore be sure that the repair is carried out by trained service technicians who carry original spare parts for your appliances.

Above, thank you again for buying Midea Built-in Oven, and we wish that our appliance will bring you delicious food and happy life.



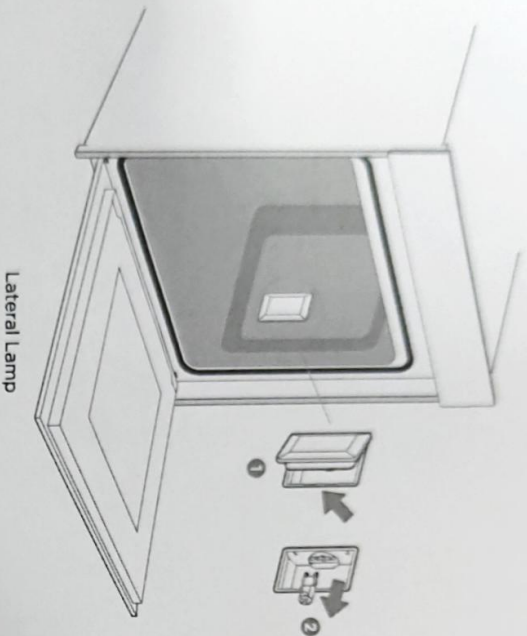

Lateral Lamp

#### Glass cover

If the glass cover of the halogen lamp is damaged, it must be replaced. You can obtain a new glass cover from the after-sales service. Please specify the E number and FD number of your appliance.

7. **Fruit juice:** when baking particularly juicy fruit pies, do not pack the baking tray too generously. Fruit juice dripping from the baking tray leaves stains that cannot be removed. If possible, use the deeper universal pan.
8. **Extremely dirty seal:** if the seal is very dirty, the appliance door will no longer close properly during operation. The fronts of adjacent units could be damaged. Always keep the seal clean.
9. **Appliance door as a seat, shelf or worktop:** Do not sit on the appliance door or place or hang anything on it. Do not place any cookware or accessories on the appliance door.
10. **Inserting accessories:** depending on the appliance model, accessories can scratch the door panel when closing the appliance door. Always insert the accessories into the cavity as far as they will go.
11. **Carrying the appliance:** do not carry or hold the appliance by the door handle. The door handle cannot support the weight of the appliance and could break.
12. **If you use the residual heat of the switched off oven to keep food warm,** a high moisture content inside the cavity can occur. This may lead to condensation and can cause corrosion damage of your high quality appliance as well as harm your kitchen. Avoid condensation by opening the door or use "Defrost" mode.

## INSTALLATION

To operate this appliance safe, please be sure that it has been installed to a professional standard respecting the installation instructions. Damages occur because of incorrect installation are not within the warranty.

While doing the installation, please wear protective gloves to prevent yourself from getting cut by sharp edges.

Check the appliance if there is any damage before installation and do not connect the appliance if there is.

Before turning on the appliance, please clean up all the packaging materials and adhesive film from the appliance.

The dimensions attached are in mm. It is necessary to have the plug accessible or incorporate a switch in the fixed wiring, in order to disconnect the appliance from the supply after installation when necessary.

Warning: The appliance must not be installed behind a decorative door in order to avoid overheating.

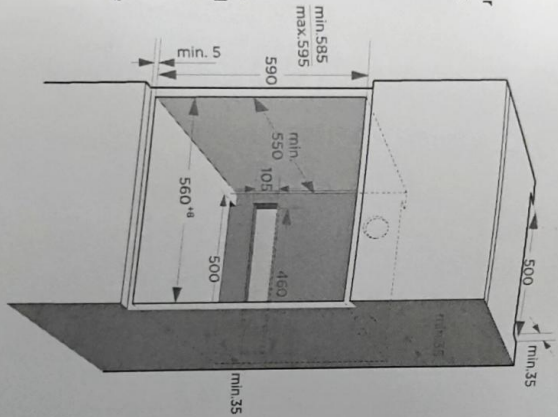
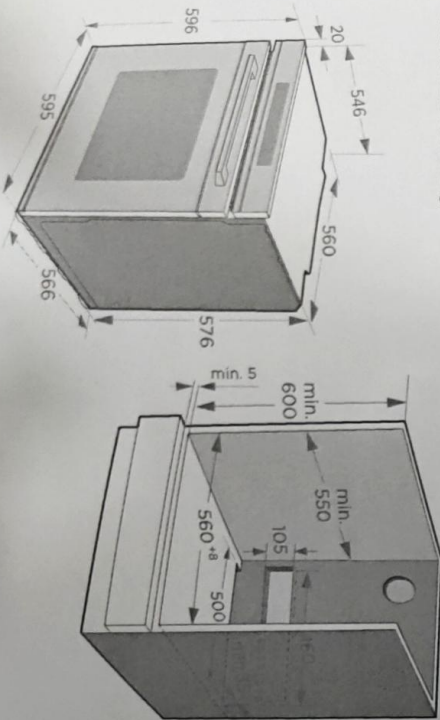

### Maximum operating time

The maximum operating time of this appliance is 9 hours, to prevent that you forget shot off the power.

### Replacing the lamp on the corner of the cavity

If the cavity lamp fails, it must be replaced. Heat-resistant, 25 watt, 230 V- halogen lamps are available from the after-sales service or specialist retailers. When handling the halogen lamp, use a dry cloth. This will increase the service life of the lamp.

## WARNING

### Risk of electric shock!

When replacing the lamp, the lamp socket contacts are live. Before replacing the lamp, unplug the appliance from the mains or switch other circuit breaker in the fuse box.

### Risk of burns!

The appliance becomes very hot. Never touch the interior surfaces of the appliance or the heating elements. Always allow the appliance to cool down. Keep children at a safe distance.

1. Place a towel in the cold cavity to prevent damage.
2. Turn the glass cover anti-clockwise to remove it (Corner lamp). Pull the lateral grid out and then pry the glass cover off slightly by a tool with a flat head (Lateral lamp)
3. Pull out the lamp - do not turn it.
4. Assemble the glass cover back in.
5. Remove the towel and switch on the circuit breaker to see if lamp switches on.
6. For the lateral lamp, if it works well after the replacement, please remember to put the lateral grid back.

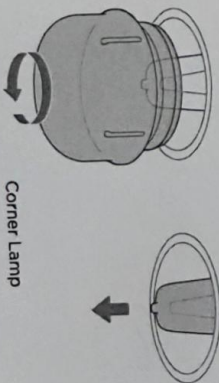

Corner Lamp

## OPERATING THE APPLIANCE

### EPB1167 MTC BK COMPONENT



1. Cancel  
Cancel the current state and enter standby mode.
2. Timer / Child-Proof Lock  
Use timer function/use child-proof lock with 3s press
3. End time  
Set an end time to the cooking duration.
4. Quick preheat  
Use this to have a quick preheat.
5. Oven - Function  
Press this symbol to change heating mode; hold on 3s to change it quickly.
6. Slider  
Slide it to change the adjustment values shown in the display.
7. Duration & Clock Setting  
Set a duration time then select function & set clock in standby mode.
8. Temperature Setting  
Press to set temperature.
9. Lamp ON / OFF  
Switch on and off the lamp.
10. Start / Pause  
Start and pause the cooking process.

<p>Knobs can no longer be turned easily.</p> <p>There is dirt under knobs</p>	<p>Knobs can be removed. To disengage knobs, simply remove them from the support.</p> <p>Alternatively, press on the outer edge of knobs so that they tip and can be picked up easily. Carefully clean the knobs using a cloth and soapy water. Dry with a soft cloth.</p> <p>Do not use any sharp or abrasive materials. Do not soak or clean in the dishwasher. Do not remove knobs too often so that the support remains stable.</p>
<p>Fan does not work all the time in the mode: "Fan Heating"</p> <p>After a cooking process a noise can be heard and a air flow in the rear of the control panel can be observed.</p>	<p>This is a normal operation due to the best possible heat distribution and best possible performance of the oven.</p> <p>The cooling fan is still working, to prevent high moisture conditions in the cavity and cool down the oven for your convenience. The cooling fan will switch off automatically.</p>
<p>The food is not sufficient cooked in the time given by the recipe.</p>	<p>A temperature different from the recipe is used. Double check the temperatures. The ingredient quantities are different to the recipe. Double check the recipe.</p>
<p>Uneven browning</p>	<p>The temperature setting is too high, or the shelf level could be optimized. Double check the recipe and settings. The surface finish and or color and or material of the baking ware were not the best choice for the selected oven function. When use radiant heat, such as "Top &amp; Bottom Heating" mode, use matt finished, dark colored and light weighted oven ware.</p>
<p>The lamp doesn't turn on</p>	<p>The lamp needs to be replaced.</p>

### Warning-Risk of electric shock!

Incorrect repairs are dangerous. Repairs may only be carried out and damaged power cables replaced by one of our trained after-sales technicians. If the appliance is defective, unplugging the appliance from the mains or switch off the circuit breaker in the fuse box. Contact the after-sales service.

# BEFORE USING THE APPLIANCE

## First using for the first time

**Before using the appliance to prepare food for the first time, you must clean the cavity and accessories.**

1. Remove all stickers, surface protection foils and transport protection parts.
  2. Remove all accessories and the side-racks from the cavity.
  3. Clean the accessories and the side-racks thoroughly using soapy water and a dish cloth or soft brush.
  4. Ensure that the cavity does not contain any leftover packaging, such as polystyrene pellets or wooden pieces which may cause risk of fire
  5. Wipe the smooth surfaces in the cavity and the door with a soft, wet cloth.
  6. To remove the new-appliance smell, heat up the appliance when empty and with the oven door closed.
  7. Keep the kitchen highly ventilated while the appliance is heating up first time. Keep children and pets out of the kitchen during this time. Close the door to the adjacent rooms.
  8. Adjust the settings indicated. You can find out how to set the heating type and the temperature in the next section.
- >Using "Your Appliance" on page 12

Settings	
Heating Mode	
Temperature	250°C
Time	1h

### After the appliance has cooled down:

1. Clean the smooth surfaces and the door with soapy water and a dish cloth.
2. Dry all surfaces
3. Install the side-racks

### Setting the time

- Before the oven can be used, the time should be set.
1. After the oven has been electrically connected, touch the clock symbol
  2. Touch clock symbol
  3. Touch clock symbol

NOTE: The clock has a 24 hour display.

## Change the power cord

Position A show the terminal box position on the back of the back outer case and it's closed.

Steps:

- a. cut off the power, use small flat screwdriver to open two snap 1, 2.
- b. use Phillips crew driver to take off screws 3, 4, 5 and 6.
- c. change the new power cord, fix the yellow/green wire on 3, brother wire on 4, blue wire on 5.
- d. twist screw 6 closed the terminal box cover finish the changing.

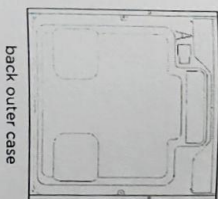

back outer case

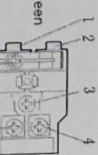

terminal box

## CURE YOUR APPLIANCE WHEN NEEDED

If a fault occurs, before calling the after-sales service, please ensure that is not because of incorrect operations and refer to the fault table, attempt to correct the fault yourself. You can often easily rectify technical faults on the appliance yourself.

If a dish does not turn out exactly as you wanted, you can find many tips and instructions for preparation at the end of the operating manual.

Fault	Possible Cause	Notes/remedy
The appliance does not work.	Faulty fuse Power cut	Check the circuit breaker in the fuse box. Check whether the kitchen light or other kitchen appliances are working.
Knobs have fallen out of the support in the control panel.	Knobs have been accidentally disengaged.	Knobs can be removed. Simply place knobs back in their support in the control panel and push them in so that they engage and can be turned as usual.

### Disassemble self-cleaning baffle

Take self-cleaning baffle out for the convenience of cleaning lateral sides of cavity:

1. Pull the side rack out from the cavity horizontally. The self-cleaning baffle will be pulled out together with the side rack.
2. Take side rack out of the cavity together with the self-cleaning baffle.
3. Separate the self-cleaning baffle from the side rack.

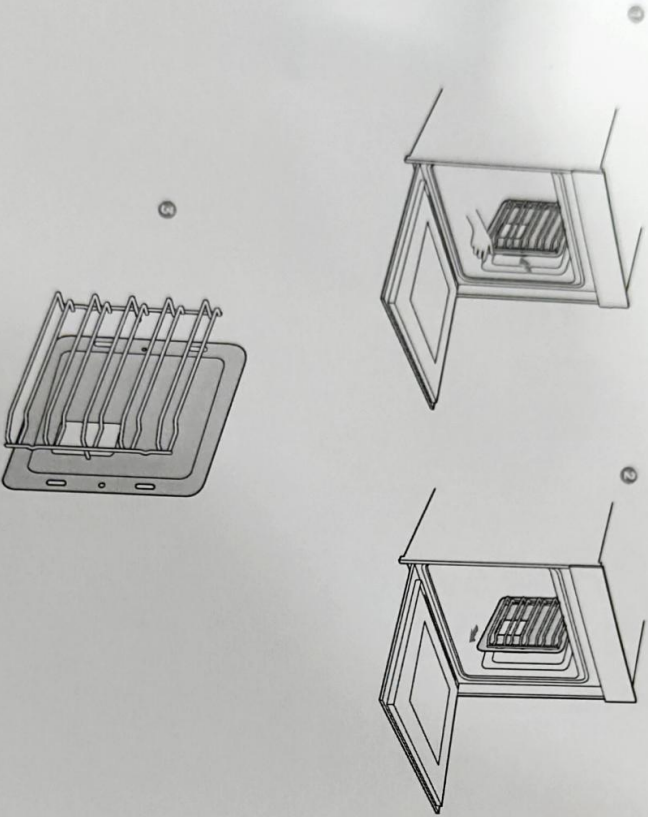

### Notes

The telescopic runners/shelves/self-cleaning baffle are optional accessories.

## TYPES OF HEATING

Your appliance has various operating modes which make your appliance easier to use. To enable you to find the correct type of heating for your dish, we have explained the differences and scopes of application here.

Types of Heating	Temperature		Use
	Temperature	Use	
Conventional	30~250°C	For traditional baking and roasting on one level. Especially suitable for cakes with moist toppings.	
Convection	50~250°C	For baking and roasting on one or more levels. Heat comes from the ring heater surrounding the fan evenly.	
ECO	140~240°C	For energy-saved cooking.	
Conventional + Fan	50~250°C	For baking and roasting on one or more levels. The fan distributes the heat from the heating elements evenly around the cavity.	
Radiant Heat	150~250°C	For grilling small amounts of food and for browning food. Please put the food in the center part under the grill heating element.	
Double Grill + Fan	50~250°C	For grilling flat items and for browning food. The fan distributes the heat evenly around the cavity.	
Double Grill	150~250°C	For grilling flat items and for browning food.	
Pizza	50~250°C	For pizza and dishes which need a lot of heat from underneath. The bottom heater and ring heater will work.	
Bottom Heat	30~220°C	For add extra browning to the bases of pizzas, pies, and pastries. Heating come from the bottom heater.	
Defrost	-	For gently defrosting frozen food.	
Fermentation	30~45°C	For making yeast dough and sourdough to prove and culturing yogurt.	

### Notes

Defrosting, fermentation and "ECO" functions cannot be preheated quickly.

**Caution!**  
If you open the appliance door during an on-going operation, the operation will not be paused, please be especially careful with the risk of burns.

#### Notes

1. To defrost big portions of food, it is possible to remove the side-racks and place the container on the cavity floor.
2. To warming tableware, it is beneficial to remove the side-racks and the heating modes "Hot Air Grilling" and "Fan Heating" with temperature setting of 50°C are useful. "Hot Air Grilling" should be used, if more than half of the cavity floor is covered by the tableware. Due to an optimum evenness of heat distribution inside the cavity during "Fan Heating", the fan will work at certain times of the heating process, to guaranty the best possible performance.

#### Cooling fan



The cooling fan switches on and off as required. The hot air escapes above the door.

#### Caution!

Do not cover the ventilation slots. Otherwise, the appliance may overheat.  
To make the appliance cools down more quickly after the operation, the cooling fan may continue to run for a period afterwards.

## USING YOUR APPLIANCE

### Cooking with oven

1. After the oven has been electrically connected, touch the oven-function symbol  to select functions, use the slider or "</>" symbol to set cooking temperature.
2. Touch Start / Pause symbol , oven begin to work, if not, oven will back to clock after 10 minutes.
3. During the cooking process, you can touch  to cancel it.

NOTE: After temperature setting, you can touch clock symbol  to set the cooking duration time, you can set it by slider or "</>" symbol.

### Quick preheat

You can use quick preheat to shorten the preheat time. When you select a function, touch the quick preheat symbol , the mark of quick preheat in the screen will light

### Remove the telescopic runners (take the left side for example, same for right side)

1. Lift up one end of the telescopic runners hard.
2. Lift up the whole telescopic runners and remove backward.

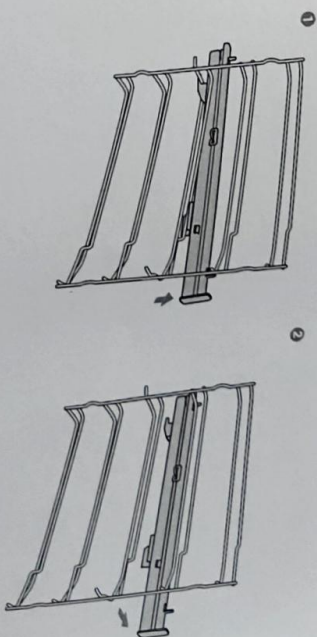

### Self-cleaning baffle

Baffle with special enamelling treatment on its surface, which can absorb oil and fat, volatilize them out later on, make cavity clean and no peculiar smell during the process of cooking.

### Fix self-cleaning baffle

Install side rack and self-cleaning baffle in turn according to direction as shown in the picture:

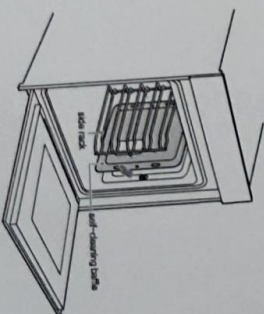

**Fix the telescopic runners**  
(take the left side for example, same for right side)

1. Put the point A and B of the telescopic runners horizontally on the outer wire.
2. Rotate the telescopic runners anti-clockwise (clockwise for right side) by 90 degrees.
3. Push forward the telescopic runners, make the point C buckled onto the lower wire and the point D buckled onto the upper wire.

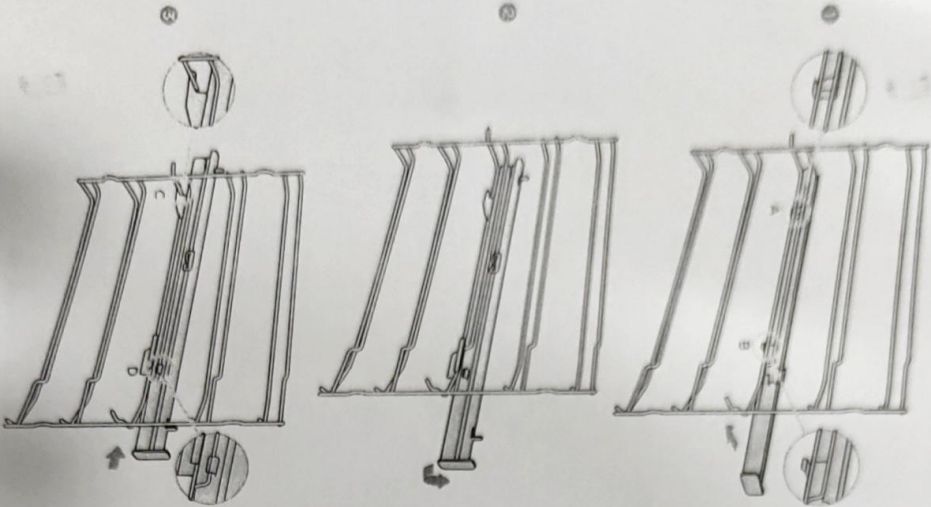

up. If this function can't detect preheat, then there will be a "beep". Defrosting, fermentation and "ECO" functions cannot be preheated quickly.

**Set a finish time**  
Then you finished the time setting, you can set a time when cooking end.

1. Touch then you can use slider or "</>" symbol to set end time in hours, touch again then set it in minutes. When you finished the setting, touch to make sure.
2. When you set the end time, you need set cooking duration time. Please check cook-ling with oven. **NOTE** to see how to set cooking duration time. Please check cook-then oven will heat up at 9 o'clock, and finish at 10 o'clock.

**Change during cooking**

During the period of appliance operating, you can change the heating type setting and temperature setting by oven-function or slider. After the change, if there no other action after 6 seconds, the oven will heat as what you changed. If you want change cooking duration time in the cooking process, please touch and change it by slider or "</>" symbol. After the change, if there no other action after 6 seconds, the oven will work as what you changed. During the cooking process, with an end time setting, you can't do any change. When you want cancel the cooking process, please touch .

**Note**

1. Changing modes/temperature/heat cooking time may have some negative influences for the result of cooking, we warmly recommend you not to do so unless you are well experienced on cooking.

**Caution!**

After the appliance switched off, it becomes very hot especially inside the cavity. Never touch the interior surfaces of the appliance or the heating elements. Use oven gloves to remove accessories or ovenware from the cavity, and allow the appliance to cool down. Keep children at a safe distance at the same time to avoid the injury of burns.

**Timer**

You can use timer function by touching . When the time arrived, oven will give "beep" for remind. At the first touch of , set timer by hours, then touch again, set timer by minutes. Touch again and the setting is finished. You can set the timer before and during cooking process, but when you are selecting function and temperature, it's not available.

### Childproof lock

Your appliance has a childproof lock so that children cannot switch it on accidentally or change any settings.

When you give a long press for 3 seconds, childproof lock is activated. A long press for 3 seconds again, the oven is unlocked. You can activate and deactivate childproof lock when the oven is work or not. Give a long press for 3 seconds, you can switch on and off the childproof lock. When the childproof is on, there will be a  in the status bar.

### EPBI 1167 MTC BK

## DEMO WITH SABBAT MODE

#### Demo mode

Demonstration mode, with power-off saving data function. Power off saving function, for example, when the demo mode is set to on, power off and then on is still on. After the demonstration mode is turned on, the heating pipe does not work.

1. In standby mode, press and hold the  key to enter the demonstration mode and display "off".
2. Slide the slider to the right to open the demonstration mode and display "off", slide the slider to the left to close the demonstration mode and display "on"; (EPBI 1167 MTC BK)

### Caution!



While the appliance door is well installed, the door cover can also be taken off, by this time,

1. Removing the door cover means to set the inner glass of the appliance door free, the glass can be easily moved and cause damage or injury.
2. As removing the door cover and inner glass means to reduce the overall weight of the appliance door. The hinges can be easier to be moved when closing the door and you may be trapped. Keep your hands away from the hinges.

Because of the 2 points above, we strongly recommend you not to remove the door cover unless the appliance door removed. Damage caused by incorrect operation is not covered under warranty.

### Rails

When you want have a good cleaning for the rails and cavity, you can remove the shelves and clean it. In this way your appliance will retain its appearance and remain fully functional for a long time to come.

1. Pull the front part of the side rails horizontally to the opposite direction until the feature  gets out. Later on you can remove the shelves out like the picture.
2. Put the side rail back into the cavity, first insert the rear part of the side rail into the hole of the cavity correctly, and then insert the front part of  into the hole into.

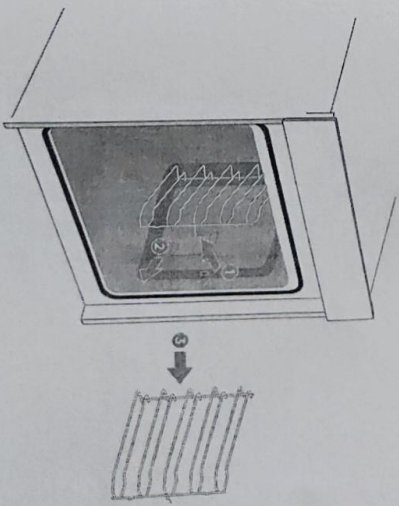



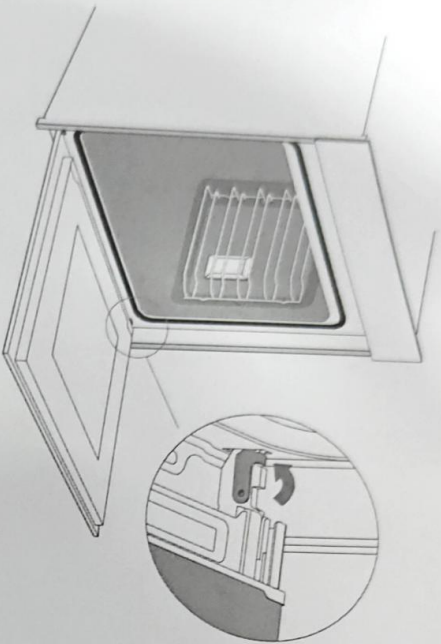

### Removing the door cover

The plastic inlay in the door cover may become discolored. To carry out thorough cleaning, you can remove the cover.

Remove the appliance door like instructed above.

1. Press on the right and left side of the cover.
2. Remove the cover.
3. After removing the door cover, that rest parts of the appliance door can be easily taken off so that you can go on with the cleaning. When the cleaning of the appliance door has finished, put the cover back in place and press on it until it clicks audibly into place.
4. Fitting the appliance door and close it.

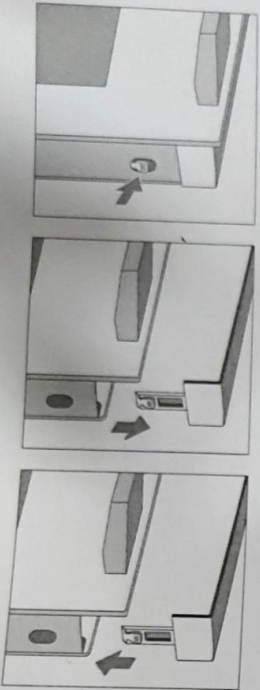

### Note:

You can press the cancel key to exit the setting, or wait for 3 seconds to automatically exit the demo mode setting state and return to the standby state.

### Sabbath mode

Sabbath mode has the function of power-off saving data. Save cooking data every 25 minutes. If the power is cut off during operation, after power on again, the Sabbath mode will continue to run until the cooking time is 0, or press the **⏪** key to return to standby mode.

1. In standby mode, press and hold the fast preheating key for 3 seconds to enter sabbath mode. The screen displays 5A8. The time adjustment range is 24-80 hours.
2. The cooking time can be adjusted by sliding the slider.
3. Press start key or start Ramadan mode automatically after 8 seconds.

### Note:

1. During operation, only the **⏪** key is valid, and other keys are invalid.
2. During the operation of sabbath mode, the furnace door is opened or closed, and the furnace light is not on.

## ACCESSORIES

Your appliance is accompanied by a range of accessories. Here, you can find an overview of the accessories included and information on how to use them correctly.

### Accessories Included

Your appliance is equipped with the following accessories:



Wire Rack

For ovenware, cake tins and ovenproof dishes. For roasts and grilled food



Baking Tray

For tray bakes and small baked products.

You can use the tray to place liquid or cooking food with juice.

Only use original accessories. They are specially adapted for your appliance.

\* You can buy accessories from the after-sales service, from specialist retailers or online.

**Note**

The accessories may deform when they become hot. This does not affect their function. Once they have cooled down again, they regain their original shape.

**Inserting accessories**

The cavity has five shelf positions. The shelf positions are counted from the bottom up. The accessories can be pulled out approximately halfway without tipping.

**Notes**

1. Ensure that you always insert the accessories into the cavity the right way round.
2. Always insert the accessories fully into the cavity so that they do not touch the appliance door.

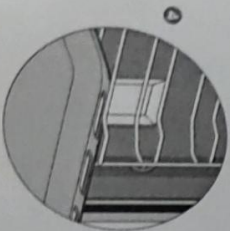
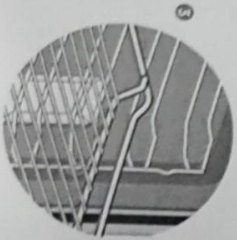
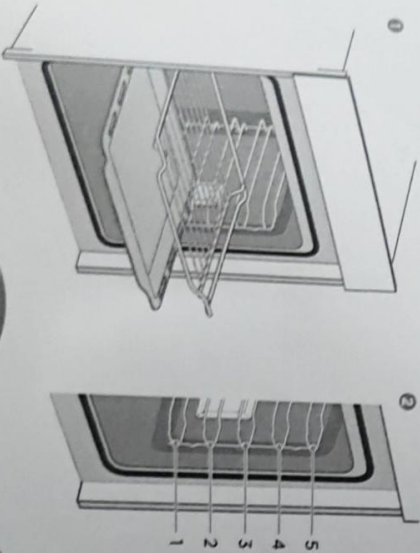

**Removing the appliance door**

1. Open the appliance door fully.
2. Fold open the two locking levers on the left and right.
3. Close the appliance door as far as the limit stop.
4. With both hands, grip the door on the left- and right-hand side, and pull it out upwards.

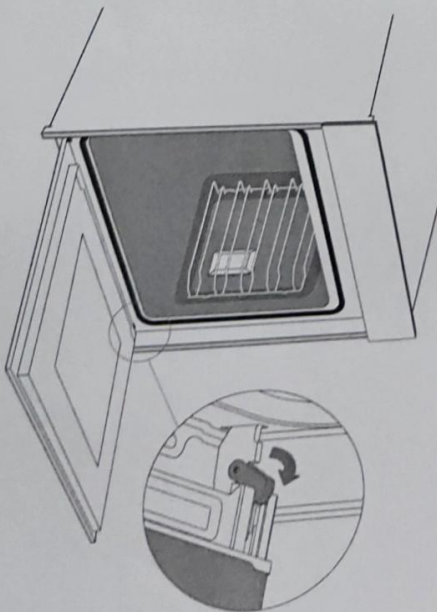

**Fitting the appliance door**

Reattach the appliance door in the opposite sequence to removal.

1. When attaching the appliance door, ensure that both hinges are placed right onto the installing holes of the front panel of the cavity. Ensure that the hinges are inserted into the correct position. You must be able to insert them easily and without resistance. If you can feel any resistance, check that the hinges are inserted into the holes right.
2. Open the appliance door fully. While opening the appliance door, you can make another check if the hinges are onto the right position. If you make the fitting wrong, you will not be able to make the appliance door fully opened. Fold both locking levers closed again.
3. Close the cooking compartment door. By the same time, we warmly recommend you to check one more time, if the door is onto the right position and if the ventilation slots are not half-sealed.

3. Enamel is baked on at very high temperatures. This can cause some slight color variation. This is normal and does not affect operation. The edges of thin trays cannot be completely enamelled. As a result, these edges can be rough. This does not impair the anti-corrosion protection.
4. Always keep the appliance clean and remove dirt immediately so that stubborn deposits of dirt do not build up.

#### Tips

1. Clean the cooking compartment after each use. This will ensure that dirt cannot be baked on.
2. Always remove flecks of lime scale, grease, starch and albumin (e.g. egg white) immediately.
3. Remove flecks of food with sugar content immediately, if possible, when the fleck is still warm.
4. Use suitable ovenware for roasting, e.g. a roasting dish.

## APPLIANCE DOOR

With good care and cleaning, your appliance will retain its appearance and remain fully functional for a long time to come. This will tell you how to remove the appliance door and clean it.

For cleaning purposes and to remove the door panels, you can detach the appliance door. The appliance door hinges each have a locking lever. The appliance door is secured in place. It cannot be detached. When the locking levers are closed, the appliance door is closed, the hinges are locked. When the locking levers are open in order to detach the appliance door, the hinges are locked. They cannot snap shut.

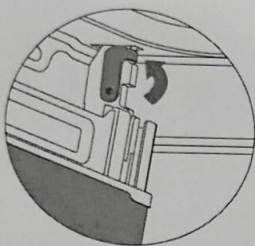
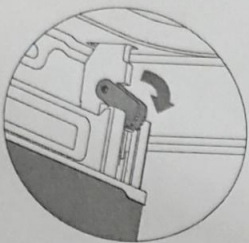

### Warning – Risk of injury!

1. If the hinges are not locked, they can snap shut with great force. Ensure that the locking levers are always fully closed or, when detaching the appliance door, fully open.
2. The hinges on the appliance door move when opening and closing the door, and you may be trapped. Keep your hands away from the hinges.

### Tilt protection

Accessories can be approximately pulled halfway out until they lock in place. The locking function prevents accessories from tilting with the gravity of food and accessories themselves while they get pulled out. Accessories should be inserted into cavity correctly for the tilt protection. When inserting the wire rack, ensure the wire rack is onto the right facing direction like the picture ① ②.

When inserting the backing tray, ensure the backing tray is onto the right facing direction like the picture ① ②.

### Optional accessories

You can buy optional accessories from the after-sales service, from specialist retailers or online. Accessories below are available to be purchased, and you are also welcome to see your sales brochures for more details.



Rotary system

For roasting meat like chicken, turkey, rabbit and so on.



Barbecue stick

For making some barbecue like meat and vegetables.

### Inserting accessories:

- Barbecue sticks are only suitable with rotary system, when using barbecue sticks, put them onto the wire rack of rotary system. And before inserting accessories into cavity, please insure all the food is well put, then slightly insert them into level 2 of the cavity.

### Notes

1. The rotary system is not continuously rotating, you can choose to make it turned during the process of cooking based on the performance of food. Make sure you have dressed with heat insulating gloves and be careful with the heat rushing out while opening the door of the oven. The rotary system can make 90 degree rotations and probably you don't even need to turn it at all.
2. The barbecue sticks are dangerous with cuspidal heads, please make sure children and disabled people are away with them. And check sticks are not into the convention cover before oven gets turned on cause this will make damage to oven and could hurt people also.
3. We strongly suggest to use level 2 of cavity, top + bottom heating function to bake while using rotary system and barbecue sticks.

### Area Appliance exterior

### Cleaning

Area Appliance exterior	Cleaning
Door handle	<b>Hot soapy water:</b> Clean with a dish cloth and then dry with a soft cloth. If descaler comes into contact with the door handle, wipe it off immediately. Otherwise, any stains will not be able to be removed.
Enamel surfaces and self-cleaning surfaces	Observe the instructions for the surfaces of the cooking compartment that follow the table.
Glass cover for the interior lighting	<b>Hot soapy water:</b> Clean with a dish cloth and then dry with a soft cloth. If the cooking compartment is heavily soiled, use oven cleaner.
Door seal	<b>Hot soapy water:</b> Clean with a dish cloth. Do not scour.
Do not remove	
Stainless steel door cover	<b>Stainless steel cleaner:</b> Observe the manufacturer's instructions. Do not use stainless steel care products. Remove the door cover for cleaning.
Accessories	<b>Hot soapy water:</b> Soak and clean with a dish cloth or brush. If there are heavy deposits of dirt, use a stainless steel scouring pad.
Rails	<b>Hot soapy water:</b> Soak and clean with a dish cloth or brush.
Pull-out system	<b>Hot soapy water:</b> Clean with a dish cloth or a brush. Do not remove the lubricant while the pull-out rails are pulled out. It is best to clean them when they are pushed in. Do not clean in the dishwasher.

### Notes

1. Slight differences in color on the front of the appliance are caused by the use of different materials, such as glass, plastic and metal.
2. Shadows on the door panels, which look like streaks, are caused by reflections made by the interior lighting.

**Caution!**  
**Risk of surface damage**

**Do not use:**

1. Harsh or abrasive cleaning agents.
2. Cleaning agents with a high alcohol content.
3. Hard scouring pads or cleaning sponges.
4. High-pressure cleaners or steam cleaners.
5. Special cleaners for cleaning the appliance while it is hot.

Wash new sponge cloths thoroughly before use.

**Tip**

Highly recommended cleaning and care products can be purchased through the after-sales service.  
Observe the respective manufacturer's instructions.

Area Appliance exterior	Cleaning
Appliance exterior Stainless steel front	<b>Hot soapy water:</b> Clean with a dish cloth and then dry with a soft cloth. Remove flecks of limescale, grease, starch and albumin (e.g. egg white) immediately. Corrosion can form under such flecks Special stainless steel cleaning products suitable for hot surfaces are available from our after-sales service or from specialist retailers. Apply a very thin layer of the cleaning product with a soft cloth.
Plastic	<b>Hot soapy water:</b> Clean with a dish cloth and then dry with a soft cloth. Do not use glass cleaner or a glass scraper.
Painted surfaces	<b>Hot soapy water:</b> Clean with a dish cloth and then dry with a soft cloth.
Control panel	<b>Hot soapy water:</b> Clean with a dish cloth and then dry with a soft cloth. Do not use glass cleaner or a glass scraper.
Door panels	<b>Hot soapy water:</b> Clean with a dish cloth and then dry with a soft cloth. Do not use a glass scraper or a stainless steel scouring pad.

**AIR SAFEGUARD SYSTEM**

An advanced air diversion technology.  
If your appliance is equipped with an Air Safeguard (depends on the actual machine), please note:

An active-protection system that keeps you away from the unexpected heat from cool-touch door which prevents unconscious burn, to air curtain which blocks hot air. Every time when the oven door is opened, air safeguard will be activated automatically. It redirects the cool air and forms an invisible curtain in front of the cavity, blocking the burning-hot air flows directly to your face. Keep you safe with a more comfortable cooking experience.

When oven is running, the door is closed and air-safeguard is in a contractive state: like the picture ①.

After cooking, when the door is opened, the air-safeguard will automatically pop open and change the wind direction at the exhaust port to make the hot air blow downward, like the picture ②.

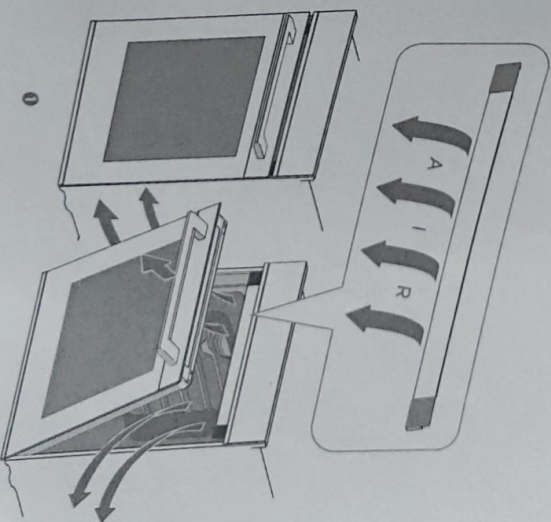

## ENERGY EFFICIENT USE

1. Remove all accessories, which are not necessary during the cooking & baking process.
2. Do not open the door during the cooking & baking process.
3. If you open the door during cooking & baking, switch the mode to "Lamp". (Without change the temperature setting)
4. Decrease the temperature setting in not fan assisted modes to 50°C at 5min to 10min before end of cooking & baking time. So you can use the cavity heat to complete the process.
5. Use "Fan Heating", whenever possible. You can reduce the temperature by 20°C to 30°C.
6. You can cook and bake using "Fan Heating" on more than one level at the same time.
7. If it is not possible to cook and bake different dishes at the same time, you can heat one after the other to use the preheat status of the oven.
8. Do not preheat the empty oven, if it is not required.  
If necessary put the food into the oven immediately after reaching the temperature indicated by switching off the indicator light the first time.
9. Do not use reflective foil, like aluminum foil to cover the cavity floor.
10. Use the timer and or a temperature probe whenever possible.
11. Use dark matt finish and light weighted baking molds and containers. Try not to use heavy accessories with shiny surfaces, like stainless steel or aluminum.

## ENVIRONMENT

The packaging is made for protect your new appliance against damages during transport. The materials used are selected carefully and should be recycled. Recycling reduces the use of raw materials and waste. Electrical and electronic appliances often contain valuable materials. Please do not dispose of it with your household waste.

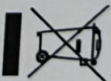

## HEALTH

Acrylamide occurs mainly by heating up starchy food (i.e. potato, French fries, bread) to very high temperatures over long times.

### Tips

1. Use short cooking times.
2. Cook food to a golden yellow surface color, do not burn it to dark brown colors.
3. Bigger portions have less acrylamide.
4. Use "Fan Heating" mode if possible.
5. French fries: Use more than 450g per tray, place them evenly spread and turn them time by time. Use the product information if available to get the best cooking result.

## MAINTENANCE YOUR APPLIANCE

### Cleaning Agent

With good care and cleaning, your appliance will retain its appearance and remain fully functioning for a long time to come. We will explain here how you should correctly care for and clean your appliance.

To ensure that the different surfaces are not damaged by using the wrong cleaning agent, observe the information in the table. Depending on the appliance model, not all of the areas listed may be on/in your appliance.

## Caution!

### Risk of surface damage

#### Do not use:

1. Harsh or abrasive cleaning agents.
2. Cleaning agents with a high alcohol content.
3. Hard scouring pads or cleaning sponges.
4. High-pressure cleaners or steam cleaners.
5. Special cleaners for cleaning the appliance while it is hot.

Wash new sponge cloths thoroughly before use.

#### Tip

Highly recommended cleaning and care products can be purchased through the after-sales service.

Observe the respective manufacturer's instructions.

Area Appliance exterior	Cleaning
Appliance exterior Stainless steel front	<b>Hot soapy water:</b> Clean with a dish cloth and then dry with a soft cloth. Remove flecks of limescale, grease, starch and albumin (e.g. egg white) immediately. Corrosion can form under such flecks Special stainless steel cleaning products suitable for hot surfaces are available from our after-sales service or from specialist retailers. Apply a very thin layer of the cleaning product with a soft cloth.
Plastic	<b>Hot soapy water:</b> Clean with a dish cloth and then dry with a soft cloth. Do not use glass cleaner or a glass scraper.
Painted surfaces	<b>Hot soapy water:</b> Clean with a dish cloth and then dry with a soft cloth.
Control panel	<b>Hot soapy water:</b> Clean with a dish cloth and then dry with a soft cloth. Do not use glass cleaner or a glass scraper.
Door panels	<b>Hot soapy water:</b> Clean with a dish cloth and then dry with a soft cloth. Do not use a glass scraper or a stainless steel scouring pad.

## AIR SAFEGUARD SYSTEM

An advanced air diversion technology.

If your appliance is equipped with an Air Safeguard (depends on the actual machine), please note:

An active-protection system that keeps you away from the unexpected heat from cool-touch door which prevents unconscious burn, to air curtain which blocks hot air inside the cavity flows over your face.

Every time when the oven door is opened, air safeguard will be activated automatically. It redirects the cool air and forms an invisible curtain in front of the cavity, blocking the burning-hot air flows directly to your face. Keep you safe with a more comfortable cooking experience.

When oven is running, the door is closed and air-safeguard is in a contractive state, like the picture ①.

After cooking, when the door is opened, the air-safeguard will automatically pop open and change the wind direction at the exhaust port to make the hot air blow downward, like the picture ②.

