

705-LF3080-01

合格证
QC PASS

深圳市神牛摄影器材有限公司

地址: 深圳市宝安区福海街道塘尾社区耀川工业区厂房2栋
电话: 0755-29609320(8062) 传真: 0755-25723423 邮箱: godox@godox.com

GODOX Photo Equipment Co., Ltd.

Add: Building 2, Yaochuan Industrial Zone, Tangwei Community, Fuhai Street, Bao'an District,
Shenzhen, China Tel: +86-755-29609320(8062) Fax: +86-755-25723423
E-mail: godox@godox.com

godox.com

Made in China



Godox

LED闪光灯
LED Flash Light

LF308D LF308Bi



说明手册

INSTRUCTION MANUAL

一、前言

感谢您购买神牛产品!

LF308系列闪光灯在传统LED灯的基础上增加了闪光功能, 既可作为LED灯使用, 又可作为闪光灯使用。非常适用于微距拍摄、婚庆拍摄、采访布光、静物拍摄以及视频拍摄等。两种型号可选: LF308D白光版(色温5600K)、LF308Bi双色温版(3300~5600K), 亮度高, 轻巧便携, 无线分组调光, 操作便捷。

主要特点:

- 一灯两用, 既可作为LED灯使用, 又可作为闪光灯使用
- 308颗高亮度灯珠, 锂电池或DC供电
- 蓝牙或2.4G无线6组32频道分组控制
- 无线调节各组亮度或色温(双色温版)
- 快速调节补光角度
- 大液晶屏, 参数自动保存
- 适用于各品牌摄像机和相机

类型	型号
白光版(色温5600K)	LF308D
双色温版(色温3300K~5600K)	LF308Bi

警告

- ⚠ 请勿将闪光灯放置在高温、高湿的地方。
- ⚠ 此机有温度保护功能, 当温度过高时进入保护状态, 当温度降低后恢复正常。
- ⚠ 请勿用湿手接触产品, 亦不可将产品浸入水中或暴露于雨中。
- ⚠ 使用电池的注意事项:
 - 切勿将电池投入火中或加热升温。
 - 当电量用尽时, 电池容易漏液。所以为了避免产品受损, 请在长期使用本产品或电量用尽时取出电池。
 - 如果受损电池中的液体接触到皮肤或衣服, 请立即用大量清水冲洗。

三、部件

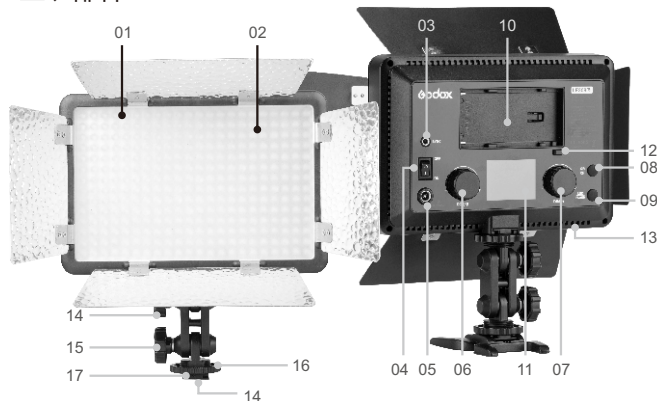

- 01. 308粒灯珠
- 02. 色温片
- 03. 3.5mm同步插孔
- 04. ON/OFF开关
- 05. DC电源插座
- 06. CCT/色温调节旋扭+造型灯按钮
- 07. DIM/亮度/功率调节旋扭+试闪按钮
- 08. GR/CH按钮
- 09. LED/FLASH切换按钮
- 10. 锂电池插槽
- 11. LCD屏(黑底白字)
- 12. 散热孔
- 13. 转轴固定旋钮A
- 14. 转轴固定旋钮B
- 15. 转轴固定旋钮
- 16. 热靴固定旋钮
- 17. 热靴连接座
- 18. 1/4" 支架安装孔
- 19. 手柄
- 20. 微型底座



四、电源管理

1. 供电方式

LF308系列LED闪光灯有2种供电方式:



● 锂电池供电
选择SONY 锂电池NP-F970, 放置于锂电池插槽内。



● 直流电源供电
6.5~12V 4A适配器,与DC电源插座连接。

注:

- 使用锂电池供电时, LCD显示当前剩余电量。当电量符号闪烁时, 表示锂电池电量极低。为了防止LED灯自动强行熄灭, 请及时对锂电池充电后再使用。
- 当使用直流电源, 电量显示满格。
- 必须使用神牛标配的适配器, 否则测试出来的指数不一致。
- 插入DC插头时自动切断锂电池。

2. 安装锂电

- (1) 关闭电源开关。
- (2) 将锂电池带插孔端对准闪光灯锂电池插槽正负极触点, 并推进卡紧。
- (3) 打开电源开关即可。
- (4) 使用完毕, 请关闭电源开关。
- (5) 取出电池: 按电池取出按键再往右推就可拿出电池。

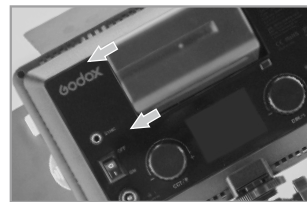

五、使用LED闪光灯



1. 机顶使用

- 转动闪光灯的热靴固定旋钮至最高点，将闪光灯热靴水平插入相机或摄像机热靴。
- 扭紧热靴固定旋钮。



3. 平放使用

- 转动闪光灯的热靴固定旋钮至最高点，将闪光灯热靴水平插入微型底座。
- 扭紧热靴固定旋钮。



2. 手持使用

- 转动闪光灯的热靴固定旋钮至最高点，将手柄固定在1/4"支架安装孔上。
- 扭紧热靴固定旋钮。



4. 灯架使用

- 转动闪光灯的热靴固定旋钮至最高点，将灯架固定在1/4"支架安装孔上。
- 扭紧热靴固定旋钮。

注：如您的摄像机没有热靴座，可以购买市面上的摄像机连接支架，通过闪光灯上的1/4"支架安装孔来固定。

六、操作说明

1. 闪光灯设置

1.1. 开/关机

- 插入锂电池或者DC电源。
- 按ON/OFF开关，闪光灯打开。
- LCD显示主机当前信息。

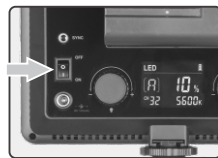

1.2. 模式选择：LED常亮模式/LED闪光模式

- 按LED/FLASH按钮切换模式：
显示屏上显示为LED即LED常亮模式，显示⚡即为闪光模式。

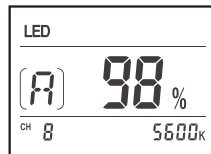

常亮模式

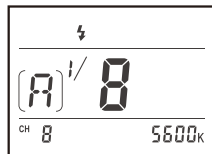

闪光模式

1.3. 亮度调节

- LED常亮模式时，旋转主机上的DIM/⚡调节旋钮可对亮度进行调整。
亮度范围0%-100%。



1.4. 色温调节

- LED常亮模式或闪光模式时，旋转主机上的CCT/☀️旋钮可对色温进行调整。

色温显示范围：

白光版LF308D	双色温版LF308Bi
5600K	3300K-5600K

注：白光版无法调节色温，LCD显示5600K。



1.5. 主机频道/组别调整

- 在常态时, 按CH/GR按钮, 此时组别闪烁, 旋转调节旋钮可选择组别(A~F)。
 - 在常态时, 长按CH/GR按钮, 此时频道闪烁, 旋转调节旋钮可选择频道(1~32)。
- 自定义功能设置: 在开机状态下, 长按LED/FLASH按钮, 进入自定义功能。

自定义功能符号	功能	设置符号	设置和说明	使用范围限制
F1	无线ID	OF 01~99	关闭ID 可选择01~99任意一个数字	无
F2	输出功率显示模式	1/P PP	显示功率方式为分数形式 显示功率方式为小数形式	闪光模式
F3	蓝牙ID号	GDB6-XXXX	蓝牙连接时选择要连接的ID号连接	无
F4	LED灯色温调节模式	01	P模式(调节色温时,亮度也跟着改变,当色温在4200K的时候亮度达到最大)	双色温灯
		02	普通模式(调节色温时,在相同亮度等级下,所有的色温亮度基本一样)	

2. 闪光模式

- 2.1. 使用闪光模式时, 可以用X系统无线引闪闪光, 无线引闪需选购神牛X系列触发器, 如X1、X2、Xpro系列、XT32等, 此类带发射功能的产品可远程调节LF308系列产品功率, 控制造型灯的开关及触发闪光灯引闪。(触发器的操作请看对应触发器说明书)。



2.2 同步孔触发

LF308系列产品带PC同步插孔, 同步插孔规格为 $\varnothing 3.5\text{mm}$ 。此处可插入同步线或者触发器(如RT、DM等)触发插头对闪光灯进行同步引闪。



2.3 造型灯

按 CCT / ● 按钮可以开关造型灯, 或用触发器控制。造型灯亮度跟随LED常亮模式。如需调节亮度请切换到LED常亮模式, 调好亮度再切换到闪光模式。

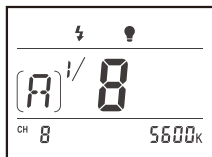

2.4 试闪

按DIM / ⚡ 按钮, LED灯将闪光或用触发器引闪。



3. LED灯模式

3.1 此模式下可使用2.4G无线遥控器无线调节其色温和亮度。

- 3.2 LED灯色温调节模式选择P模式时, 色温在4200K时亮度达到最大; 选择普通模式调节色温时, 在相同亮度等级下所有的色温亮度基本一样。

4. 无线远程控制 (遥控器另购)

4.1 2.4G无线遥控

本产品具备无线遥控功能, 使用2.4G无线技术, 无视角限制, 距离远, 可同时分别控制6组LED灯。32组通道频率, 100个无线ID, 抗干扰强。使用前请把LED主机和遥控器RC-A66的频道与组别调至一致。

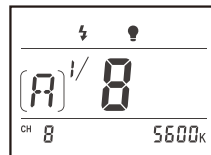

遥控器频道/组别调整

- 在常态时, 按CH/GR按钮, 此时组别闪烁, 按 "-" "+" 按钮可选择组别(A~F,0-9);
- 在常态时, 按CH/GR按钮2次, 此时频道闪烁, 按 "-" "+" 按钮可选择频道(1~32)。

遥控器ID调整

- 在常态时, 双击CH/GR按钮, 按 "-" "+" 按钮可选择ID号(ID号为OFF,01-99)。

遥控器亮度参数调节

- 在常态时, 按 "-" "+" 按钮可对亮度调整。

遥控器色温参数调节

- 在常态时, 按SET按钮, 此时色温值闪烁, 按 "-" "+" 按钮可对色温调整。

遥控器复位

- 同时按住 "-" "+" 按钮即可复位。

4.2 蓝牙无线控制

本产品还具备手机APP蓝牙无线控制功能,可同时分别控制多台LED灯。32组通道频率,抗干扰强。

- **连接蓝牙:** 在开机状态下,长按LED/FLASH按钮,进入自定义功能。旋转DIM/⚡旋钮到F3,LED灯会显示蓝牙ID号。打开APP“GodoxPhoto”,点击蓝牙选择LED灯对应的蓝牙号,输入密码(原始密码“000000”),蓝牙连接成功。



当同时用多台带蓝牙模块的LED灯组合使用时,APP可以同时控制多台LED灯。与手机蓝牙连接成功的机作为主机,其他机为从机,主机将手机APP数据广播出去,从机接收到与其通道和组别匹配的数据以实现调控。



- **LED控制和闪光控制:** 具体操作请看手机APP“GodoxPhoto”:设置---帮助。

注: 主机在开机状态下才可以接收无线信号。

其他操作说明

- 按遥控器的ON/OFF按键,只可打开或者关闭所有组别的LED灯的当前状态,无法对LED灯开机或关机。LED灯在接收遥控器的“OFF”指令后,灯光消失,LCD屏变暗且只显示“OF”。
- 长按遥控器“SET”按钮2秒,可关闭或者打开当前组别的LED灯。

遥控器使用提示:

- (1)使用白光版时,请把遥控器的色温值固定在5600K。
- (2)长时间不使用,请取出电池。

5. 滤色片更换

- 用手轻轻捏住色温片向右拉出。
- 将新色温片直接插入,向左推移,色温片更换完毕。

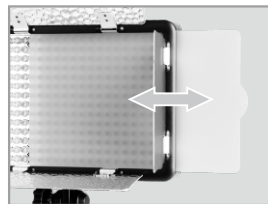

七、标配物品

序号	包含物品	LF308D (5600K)	LF308Bi (3300K~5600K)
1	LED闪光灯	1个	1个
2	适配器	1个	1个
3	手柄	1个	1个
4	微型底座	1个	1个
5	柔光片	1个	1个
6	黄色滤色片	1个	无
7	蓝色滤色片	1个	无



八、产品参数

LED闪光灯	白光版LF308D	双色温版LF308Bi
锂电池供电	7.4V锂电池(NP-F970接口)(需另购)	
DC电源供电	6.5~12V 4A	
频道	32个	
组别	6组(A、B、C、D、E、F)	
功率	最大18W	
色温	5600K±300K	3300K~5600K ±300K
100%光照度(LUX)	LUX≤1300 (1 米)	LUX≤1200 (1 米)
调光范围	0%~100%	
闪光功率调控	OF, 7.0-10 (1/8-1/1)	
闪光触发控制方式	同步线插孔, 试闪按钮, 2.4G无线, 蓝牙	
灯珠数量	308个	308个(5600K: 154个; 3300K: 154个)
工作环境温度	-10~50度	
产品尺寸	180mm*185mm*40mm (不包含手柄尺寸)	
净重	400g	

设计和规格如有变更, 恕不另行通知。

Foreword:

Thank you for purchasing this Godox Product!

LED Flash Light LF308 series add flash functions based on the traditional LED light. LF308 series can be served as a flash, as well as an LED light. It's excellent for macrophotography, product shooting, photojournalistic and video recording, etc. The lightweight and portable light provides high brightness and accurate color temperature. Two models are available: LF308D Daylight Version Version (5600K) and LF308Bi Bicolor Version (3300K).

Features:

- Can both serve as a flash and an LED light
- 308-LED-bulbs panel is lithium-ion or DC powered
- Bluetooth or 2.4G wireless grouping system (6 groups & 16 channels)
- Wirelessly adjust brightness or color temperature(bicolor version)
- Include an adapter, a remote control, a portable handle and a mini stand
- Quickly change panel angle
- Large-sized LCD panel & settings auto saved
- Fits almost any cameras and camcorders

Type	Model
Daylight Version (Color Temperature 5600K)	LF308D
Bicolor Version (Color Temperature 3300K~5600K)	LF308Bi

⚠ Warning:

- ⚠ Do not place in high temperature or high humidity conditions.
- ⚠ If this product overheats, it will cease operation and resume working after cooling down. This is due to the built-in overtemperature protection.
- ⚠ Do not handle with wet hands, immerse in water, or expose to rain.
- ⚠ Observe precautions when handling batteries:
 - Do not mix new and used batteries or batteries of different types.
 - Do not put batteries into a fire or apply direct heat to it.
 - Batteries are prone to leakage when fully discharged. To avoid damage to the product, be sure to remove batteries out when the product will not be used for a long time or when batteries run out of charge.
 - Should liquid from batteries come into contact with skin or clothing, rinse immediately with fresh water.

Parts

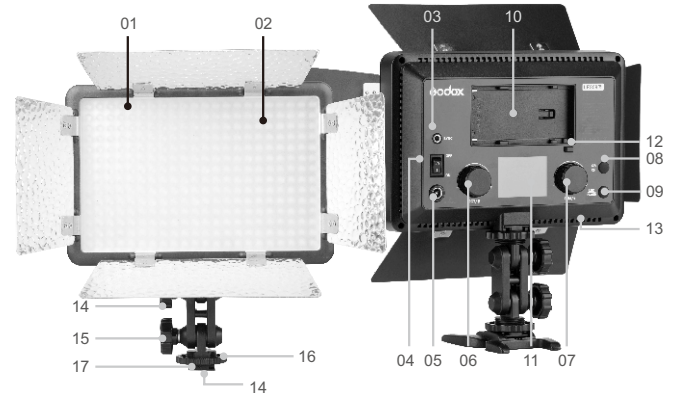

Body

- 01. 308 LED Beads
- 02. Color Filters
- 03. 3.5mm Sync Cord Jack
- 04. Power Switch
- 05. DC Power Jack
- 06. **CCT** Color Temperature
Select Dial + Modeling Lamp Button
- 07. **DIM** Light Brightness/
Power Select Dial + Test Button
- 08. GR/CH Button
- 09. LED/Flash Button
- 10. Lithium Battery Compartment
- 11. LCD Panel (White in Black)
- 12. Battery Release Button
- 13. Heat Dissipation Hole
- 14. Angle Adjusting Knob A
- 15. Angle Adjusting Knob B
- 16. Locking Ring
- 17. Camera Hotshoe
Connection
- 18. 1/4" Bracket
Mounting Hole
- 19. Handle
- 20. Mini Stand

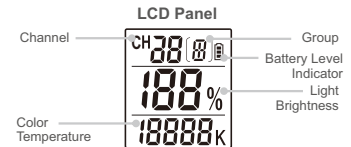

Power Management

1. Power Supply

Two power supply modes are available:



• Using lithium battery:

Choose SONY NP-F970 model lithium battery (separately sold) and install them correctly.

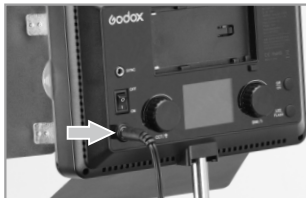

• Using DC power jack:

This light can be powered by DC power supply. Use a 6.5~12V 4A adapter (purchased separately) to connect the light with the DC power supply.

Note:

- When using lithium battery, the Battery Level Indicator is displayed on the LCD panel. When the indicator blinks, the lithium battery power is low. Please recharge it immediately before usage in order to avoid forceful auto off.
- When using DC power supply, the Battery Level Indicator will be displayed as full.
- Must use the included Godox adapter, otherwise, the tested index may not be in accordance with instruction manual.
- The lithium battery will be disconnected when inserting DC power source.

2. Installing Lithium Battery

- (1) Turn the Power Switch off.
- (2) Target the socket of the lithium battery towards the "+" "-" contacts of the Battery Compartment. Push the battery in until it locks.
- (3) Power the light on.
- (4) After using the light, please power it off.
- (5) Press the Battery Release Button and push rightwards to take the battery out.



Using the LED Flash Light



1. On the Camera

- Screw the Locking Ring to the highest point and insert the Camera Hotshoe Connection horizontally into the hotshoe of a camera or a camcorder.
- Tighten the Locking Ring.

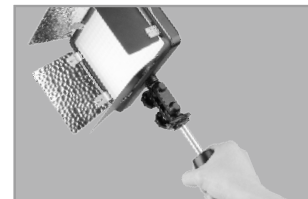

2. By the Handle

- Screw the Locking Ring to the highest point and insert the Camera Hotshoe Connection horizontally into the hotshoe of a camera or a camcorder.
- Tighten the Locking Ring.

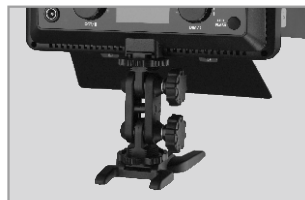

3. On the Mini Stand

- Screw the Locking Ring to the highest point and insert the Camera Hotshoe Connection horizontally into the hotshoe of the mini stand.
- Tighten the Locking Ring.



4. On the Light Stand

- Screw the Locking Ring to the highest point and install the light stand onto the 1/4" Bracket Mounting Hole.
- Tighten the Locking Ring.

Note: If your camcorder has no hotshoe connection, you are advised to purchase a connecting bracket for camcorder. The video light has a 1/4" Bracket Mounting Hole as your camcorder does. Therefore, you can easily connect both the light and the camcorder to the bracket.

Operation

1. Flash Setting

1.1 Before Usage

- Insert the lithium battery or connect the light with the DC power supply.
- Switch the power on, the video light giving out light.
- LCD panel shows the information.



1.2 Mode Selection:

LED Mode/Flash Mode

- Press LED/FLASH Button to switch different mode: the light will be served as LED if LED is displayed while being served as flash if is displayed.

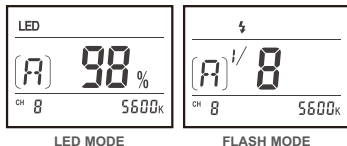

LED MODE

FLASH MODE

1.3 Light Brightness Adjustment

- In LED mode, turn the DIM/ button to adjust the light brightness from 0% to 100%.



1.4 Color Temperature Adjustment

- In LED mode or flash mode, turn the CCT/ button to adjust color temperature.

Color temperature range:

Daylight Version	Bicolor Version
LF308D	LF308Bi
5600K	3300K-5600K



NOTE: Color temperature of LED 308D (Daylight Version) is invariable. The LCD panel only shows 5600K.

1.5 Adjusting Channel/Group of the LED Flash Light

- Press the CH/GR button and the group icon blinks. Turn the select dial to choose a group (A to F).
- Press the CH/GR button twice and the channel icon blinks. Turn the select dial to choose a channel (1 to 32).

Custom Function Settings: when turning on the flash, long press the LED/FLASH button and enter custom function settings.

Custom Function Signs	Function	Setting Signs	Settings & Description	Restrictions
F1	Wireless ID	OF 01-99	Wireless ID is off Choose any figure from 01 to 99	No
F2	Power output display mode	1/P	Display power in the form of fractions	Flash mode
		P/P	Display power in the form of fraction decimal	
F3	Bluetooth ID	GDBG-XXXX	Choose the ID to be connected	No
F4	Color temperature adjusting mode of LED light	01	P mode(light brightness changes with the color temperature and reach to the max. value in 4200K)	Bicolor light
		02	General mode(when adjusting color temperature, the light brightness in the same level nearly keep the same value in all color temperature)	

2. Flash Mode

2.1 In flash mode, X system wireless triggering can be achieved. It is recommended to separately purchase Godox X series flash trigger, e.g. X1, X2, XPro series, XT32, etc. The products with transmitting functions can remote control LF series' power, modeling lamp' s ON/OFF and triggering. Please refer to relevant instruction manuals of flash triggers for more details.



2.2 Sync Triggering

The sync cord jack of LF308 is a Φ 3.5mm plug. Insert a trigger(e.g. RT and DM flash trigger) plug here and the flash will be fired synchronously with the camera shutter.

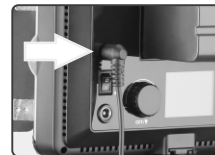

2.3 Modeling Lamp

In flash mode, press the DIM/ button can switch on or off the modeling lamp. Or use a flash trigger to control it. The modeling lamp's light brightness will change with brightness value in LED mode. If light brightness adjustment is needed, please switch to LED mode and back to the flash mode after adjustment finished.

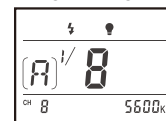

2.4 Test

Press **CCT** button, and the LED light will fire a flash or using a flash trigger to control it.



3. LED Mode

- 3.1 In this mode, 2.4G wireless remote control can be applied to wirelessly adjust the light's color temperature and light brightness.
- 3.2 When choosing P mode in color temperature adjusting mode of LED light, the light brightness reaches to the max. value in 4200K. When choosing general mode, the light brightness in the same level nearly keep the same value in all color temperature.

4. Wireless Remote Control

4.1 2.4G Wireless Remote Control

With 2.4G wireless system, this product has remote grouping and control function. Up to 6 groups of LED light can be controlled. 32 channels are available with strong anti-interference capability.

Please set the channels and groups of LED Flash Light to the same as those of RC-A6 remote control before usage.

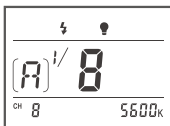

Adjusting Channel/Group with the Remote Control

- Press the CH/GR button and the group icon blinks. Press the "-" "+" button to choose a group (A to F, 0 to 9).
- Press the CH/GR button twice and the channel icon blinks. Press the "-" "+" button to choose a channel (1 to 32).

Adjusting ID with the Remote Control

- Double click the CH/GR button and press the "-" "+" button to choose ID from OFF or 0 to 99.

Adjusting Light Brightness with the Remote Control

- Press the "-" "+" button to adjust the light brightness.

Adjusting Color Temperature with the Remote Control

- Press the SET button of the remote control and the color temperature icon blinks. Press the "-" "+" button to adjust the color temperature.

Remote control reset: press down "-" and "+" button simultaneously to reset.

Note: Remote control purchased separately

4.2 Bluetooth Wireless Remote Control

This LED light can also be wirelessly controlled by smartphone APP through Bluetooth. 32 channels are available with strong anti-interference capability.

- **Bluetooth connection:** when turn the LED light on, long press the LED/FLASH button and enter C.Fn custom functions. Turn the button to F3, Bluetooth ID will be displayed on the LCD panel. Open the GodoxPhoto APP and click Bluetooth to choose the corresponding Bluetooth ID. Enter the password (original password is 000000) and the Bluetooth is successfully connected.



When using in combination with multiple LED lights with Bluetooth, APP can be applied to control those LED lights simultaneously. Use one light as mast unit and others as slave units. The mast unit will transmit the parameters to slave unit and the slave units will receive the data which belongs to their own channels and groups.



- **LED control and flash control:** please refer to Settings---Help in "GodoxPhoto" APP to see more detail.

Other Operation Tips:

- Pressing the ON/OFF button on the remote control can only turn on/off all the LED groups instead of powering it on or off. When received the "OFF" command from the remote control, LED Flash Light stop lighting up and LCD panel gets dark with "OF" displayed.
- Pressing the "SET" button on the remote control for 2 seconds can only turn on/off the current LED group.

Tips of Using Remote Control:

- (1) When using the Daylight Version LF308D, please set the color temperature of the remote control as 5600K constantly.
- (2) Please remove the battery if the light will not be used for an extended period of time.

5. Replacing A Color Filter

- Pinch the edge of the color filter and pull it out.
- Insert a new color filter in and push it to the left.
Then the color filter is securely in position.

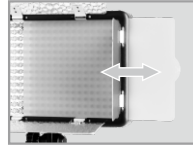

What's in the Box of LF308?

NO.	Included Item	LF308D (5600K)	LF308Bi (3300K~5600K)
1	LED Flash Light	1 PC	1 PC
2	Adapter	1 PC	1 PC
3	Handle	1 PC	1 PC
4	Mini Stand	1 PC	1 PC
5	Diffusion Filter	1 PC	1 PC
6	Yellow Filter	1 PC	NO
7	Blue Filter	1 PC	NO



LED Flash Light



Mini Stand



Handle



Adapter

Technical Data:

LED Flash Light	Daylight Version LF308D	Bicolor Version LF308Bi
Lithium Battery	7.4V Lithium Battery(SONY NP-F970 model lithium battery) (sold separately)	
DC Power Supply	6.5~12V 4A	
Channel	32	
Group	6 groups(A, B, C, D, E, F)	
Power	Max. 18W	
Color Temperature	5600K±300K	3300K~5600K ±300K
100% Light Brightness (LUX)	LUX≤1300 (1 m)	LUX≤1200 (1 m)
Light Brightness Range	0%~100%	
Power Output Control	OF, 7.0-10(1/8-1/1)	
Triggering Method	Sync cord, test button, 2.4G wireless, Bluetooth	
LED Beads Quantity	308	308 (5600K: 154; 3300K: 154)
Operation Temperature	-10~40 °C	
Dimension	180mm*185mm*40mm(not with the Handle)	
Net Weight	400g	
BT Frequency Range	2402.0-2480.0MHz	
Max. Transmitting Power	5dbm	

* Product design and specifications are subject to change without notice.

FCC Statement

This device complies with part 15 of the FCC Rules. Operation is subject to the following two conditions: (1) This device may not cause harmful interference, and (2) this device must accept any interference received, including interference that may cause undesired operation.

Any Changes or modifications not expressly approved by the party responsible for compliance could void the user's authority to operate the equipment.

Note: This equipment has been tested and found to comply with the limits for a Class B digital device, pursuant to part 15 of the FCC Rules. These limits are designed to provide reasonable protection against harmful interference in a residential installation. This equipment generates uses and can radiate radio frequency energy and, if not installed and used in accordance with the instructions, may cause harmful interference to radio communications. However, there is no guarantee that interference will not occur in a particular installation. If this equipment does cause harmful interference to radio or television reception, which can be determined by turning the equipment off and on, the user is encouraged to try to correct the interference by one or more of the following measures:

- Reorient or relocate the receiving antenna.
- Increase the separation between the equipment and receiver.
- Connect the equipment into an outlet on a circuit different from that to which the receiver is connected.
- Consult the dealer or an experienced radio/TV technician for help.

The device has been evaluated to meet general RF exposure requirement.
The device can be used in portable exposure condition without restriction.

产品保修

尊敬的用户，本保修卡是申请维修服务的重要凭证，请您配合销售商填写并妥善保管，谢谢！

产品信息	型号	产品条码
用户信息	姓名	联系电话
	通信地址	
销售商信息	名称	
	联系电话	
	通信地址	
	销售日期	
备注		

注：此表应由销售商盖章确认。

如何获得维修服务

要维修服务，您可直接与产品销售商或授权服务机构联系，也可拨打神牛产品售后服务电话，与我们联系，由我们的服务人员为您安排服务。申请保修时，您应提供有效的保修卡作为保修凭证，方可获得保修。如您不能提供有效的保修卡，则在我们可确认产品或部件属于保修范围的情况下，也可以为您提供保修，但这不作为我们的义务。

不适用保修的情况

如产品存在下列情况，本文件项下的保证和服务将不适用 ①产品或部件超过相应保修期；②错误或不适当使用、维护或保管导致的故障或损坏，如：不当搬运；非按产品合理预期用途使用；不当插拔外接设备；跌落或外力挤压；接触或暴露于不当温度、溶剂、酸碱、水浸或潮湿环境；③由非神牛授权机构或人员安装、修理、更改、添加或拆卸造成的故障或损坏；④产品或部件原有识别信息被修改变更或除去；⑤无有效保修卡；⑥使用非合法授权、非标准或非公开发行的软件造成的故障或损坏；⑦因不可抗力或意外事件造成的故障或损坏；⑧其他非因产品本身质量问题导致的故障或损坏。遇上述情况，您应向相关责任方寻求解决，神牛对此不承担任何责任。因非在保修期或保修范围内的部件、附件或软件导致产品不能正常使用的，不是保修范围内的故障。产品使用过程中正常的脱色，磨损和消耗，不是保修范围内的故障。

产品保修和服务支持信息

产品的保修期和服务类型按以下《产品保修信息》执行：

产品类别	选项名称	保修期(月)	保修服务类型
部件	电路板	12	客户送修
	电池	3	客户送修
	充电器、电源线、同步线等带电性能的部件。	12	客户送修
其他	如闪光灯、造型灯泡、外壳、保护罩、锁紧装置、包装等。	无	无保修

神牛产品售后服务电话 0755-29609320-8062

适用产品

本文件适用于相关《产品保修信息》(见后面说明)所列产品，其他非属此范围的产品或部件(如促销品、赠品及其他出厂后附加的部件等)不在此保修承诺内。

保修期

产品及部件的相应保修期按相关的《产品保修信息》执行。保修期自产品首次购买日起算，购买日以购买产品时保修卡登记日期为准。

Warranty

Dear customers, as this warranty card is an important certificate to apply for our maintenance service, please fill in the following form in coordination with the seller and safekeep it. Thank you!

Product Information	Model	Product Code Number
Customer Information	Name	Contact Number
	Address	
Seller Information	Name	
	Contact Number	
	Address	
	Date of Sale	
Note:		

Note: This form shall be sealed by the seller.

Warranty Period

The warranty period of products and accessories is implemented according to the relevant Product Maintenance Information. The warranty period is calculated from the day (purchase date) when the product is bought for the first time. And the purchase date is considered as the date registered on the warranty card when buying the product.

How to Get the Maintenance Service

If maintenance service is needed, you can directly contact the product distributor or authorized service institutions. You can also contact the Godox after-sale service call and we will offer you service. When applying for maintenance service, you should provide valid warranty card. If you cannot provide valid warranty card, we may offer you maintenance service once confirmed that the product or accessory is involved in the maintenance scope, but that shall not be considered as our obligation.

Inapplicable Cases

The guarantee and service offered by this document are not applicable in the following cases: ①. The product or accessory has expired its warranty period; ②. Breakage or damage caused by inappropriate usage, maintenance or preservation, such as improper packing, improper usage, improper plugging in/out external equipment, falling off or squeezing by external force, contacting or exposing to the improper temperature, solvent, acid, base, flooding and damp environments, etc; ③. Breakage or damage caused by non-authorized institution or staff in the process of installation, maintenance, alternation, addition and detachment; ④. The original identifying information of product or accessory is modified, alternated, or removed; ⑤. No valid warranty card; ⑥. Breakage or damage caused by using illegally authorized, nonstandard or non-public released software; ⑦. Breakage or damage caused by force majeure or accident; ⑧. Breakage or damage that could not be attributed to the product itself. Once met these situations above, you should seek solutions from the related responsible parties and Godox assumes no responsibility. The damage caused by parts, accessories and software that beyond the warranty period or scope is not included in our maintenance scope. The normal discoloration, abrasion and consumption are not the breakage within the maintenance scope.

Maintenance and Service Support Information

The warranty period and service types of products are implemented according to the following Product Maintenance Information:

Product Type	Name	Maintenance Period(month)	Warranty Service Type
Parts	Circuit Board	12	Customer sends the product to designated site
	Battery	3	Customer sends the product to designated site
	Electrical parts e.g.battery charger, power cord, sync cable, etc.	12	Customer sends the product to designated site
Other Items	Flash tube, modeling lamp, lamp body, lamp cover, locking device, package, etc.	No	Without warranty

Godox After-sale Service Call **0755-29609320-8062**

Applicable Products

The document applies to the products listed on the Product Maintenance Information (see below for further information). Other products or accessories (e.g. promotional items, giveaways and additional accessories attached, etc.) are not included in this warranty scope.