

instructions

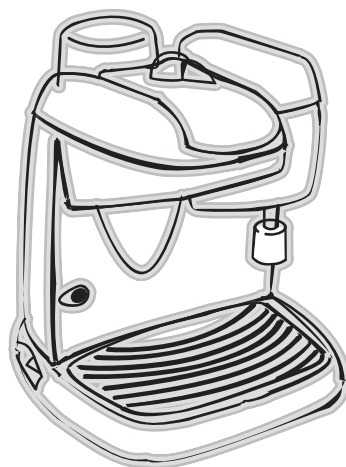

Coffee Maker EC9

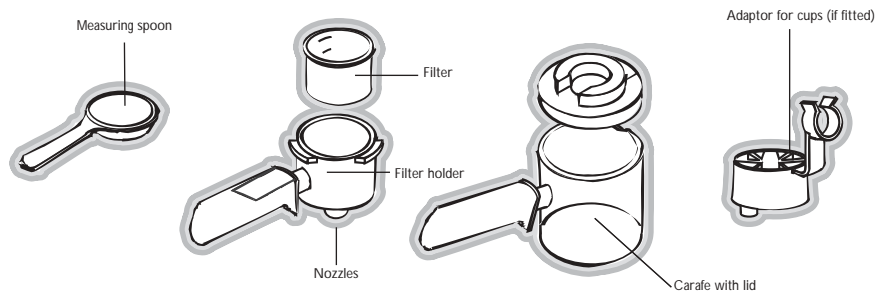

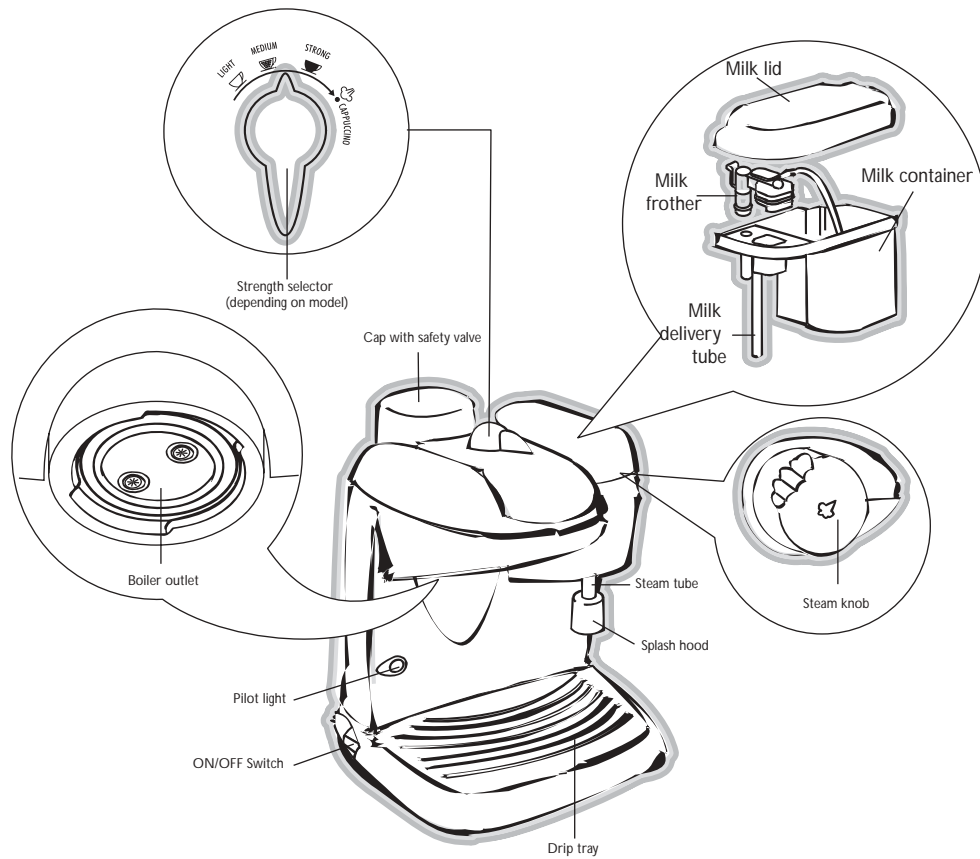

Coffee Maker EC9

Thank you for choosing this coffee machine. To get the very best out of your new coffee machine it is advisable to read these instructions before using the appliance. This is the only way to ensure optimum results and maximum safety.

Using for the first time

Carefully unpack the coffee maker and remove all the packaging material. Before using wash the accessories and surfaces. Do not immerse the coffee maker in water; simply wipe with a cloth and mild detergent if necessary. Do not put in the dishwasher or use harsh, abrasive cleaners.

For the best tasting results prior to making coffee we recommend that you flush the coffee maker out with cold water only, without using coffee to remove any dust which may still be inside the coffee maker. To do this follow the directions 'Preparing the coffee'.

Installation

- Place the coffee maker on a flat work surface at a safe distance from taps and sinks.
- Check that the voltage corresponds to that indicated on the appliance rating plate. The appliance must always be connected to a well-earthed socket rated at 10A minimum. The manufacturer is not liable for damage caused by inadequate earthing of the appliance.
- In the event of incompatibility between the plug on the appliance and the socket, have the plug replaced by a qualified service engineer.
If the cable is damaged or requires replacing, contact a service centre authorised by the manufacturer only.
- Never install the machine in an environment that can reach a temperature less than or equal to 0°C (the appliance may be damaged if the water freezes).

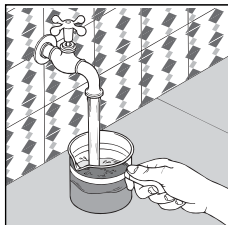

fig. 1

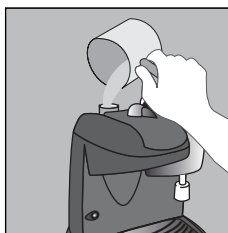

fig. 2

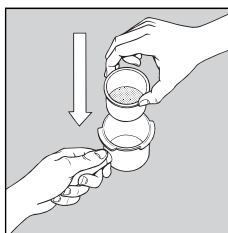

fig. 3

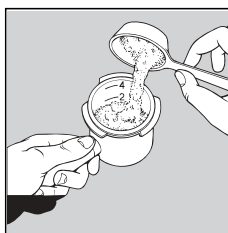

fig. 4

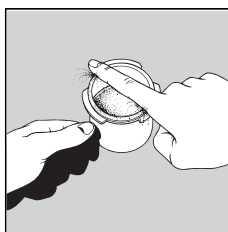

fig. 5

How to prepare the espresso coffee

- 1 Unscrew the water tank cap by turning it anti-clockwise.
- 2 Using the carafe supplied (fig. 1) pour water into the boiler (fig. 2) according to the amounts shown in the table on page 10.
Do not exceed the amounts shown as this could cause the appliance to malfunction.

While filling the boiler make sure the ON/OFF switch is in the OFF position.

- 3 Carefully close the boiler cap by turning it clockwise.
- 4 Insert the filter into the filter-holder. (fig. 3).
- 5 Fill the filter with ground coffee using the measures described in the table (page 10) about 7 g per cup. Fill the filter evenly in small doses to prevent the ground coffee from overflowing. (fig. 4).

IMPORTANT: Before adding the ground coffee to the filter holder, make sure there is no coffee left from previous usage.

It is important to use medium ground coffee. (Avoid using too finely ground coffee otherwise the filter can become blocked).

- 6 Remove any excess coffee from the filter rim (fig. 5).
- 7 Attach the filter holder to the machine by positioning the handle to the left of the boiler outlet, then pushing upwards and turning the handle to the right (fig. 6).
- 8 Place the carafe with the lid on the drip tray, make sure the nozzles on the filter holder fit inside the opening on the carafe's lid (fig. 7).

Make sure that the steam knob is turned off.

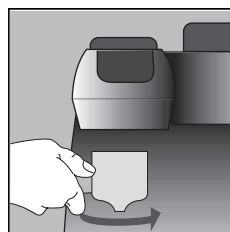

fig. 6

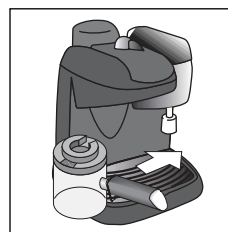

fig. 7



Coffee Maker EC9

- 9 Position the strength selector according to the flavour of coffee desired, "light", "medium" or "strong" (fig.8).
- 10 Press the ON/OFF switch (fig. 9). The pilot light will light up.
- 11 The coffee will start to flow after approximately three minutes. Turn off the power switch after sufficient coffee has been dispensed.
- 12 Before removing the filter holder, residual pressure must be released by slowly turning the steam knob (fig. 10) so that the residual steam can escape.
 Note: for safety reasons the cap turns freely and cannot be opened when the boiler is hot. The tank therefore cannot be refilled until all the water has been used or until the boiler cools down (to make this a quicker process, open the steam knob).
- 13 To detach the filter holder, turn the handle from right to left. To remove the used coffee lock the filter with the built-in lever and let the coffee fall out by knocking the over turned filter holder.

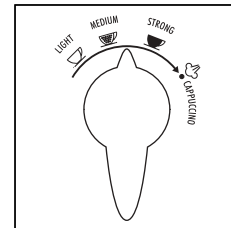

fig. 8

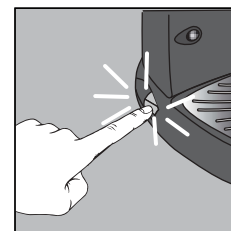

fig. 9



fig. 10

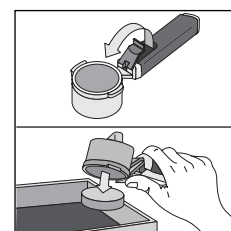

fig. 11

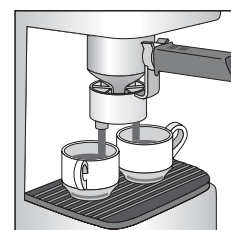

fig. 12

Coffee made directly into cups

The carafe can be used to make 2 or 4 cups of coffee. If you prefer to make 2 cups only, fit the adaptor for cups to the lower section of the filter-holder (fig. 12) and place the cups directly underneath the nozzles. This will allow the coffee to flow directly into the cups.

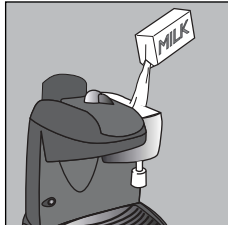

fig. 13

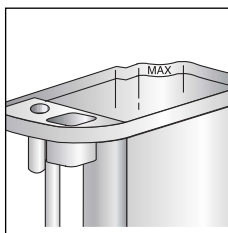

fig. 14



fig. 15

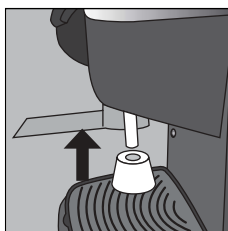

fig. 16

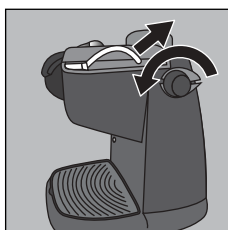

fig. 17

Making Cappuccino

A cappuccino is an espresso coffee with a froth topping made by heating milk.

- 1 Pour the quantity of milk required to make the cappuccino coffees (about 100 ml for each cappuccino) into the milk container (E) (fig. 13). Never exceed the MAX level (corresponding to about 250 mls) marked on the tank (fig. 14) as milk may continue to drip from the milk tank tube after the cappuccino has been made. Always use fresh cold milk. Never use hot milk.
- 2 When preparing four cappuccino coffees, the milk in the tank must be topped up.
- 3 Follow the steps 1-10 in the paragraph "Making Espresso Coffee". Note that the amount of water needed to make 2 cups of cappuccino is greater than that required for 2 cups of normal coffee as it is also necessary to produce the steam to froth the milk.
For best results the strength selector should be set to "MEDIUM".
- 4 Allow the coffee to drip into the carafe until it reaches the number 2 or 4 marked on the side of the carafe, then select "CAPPUCCINO".
- 5 Pour the coffee into the cups and place one cup at a time underneath the steam tube.
- 6 Rotate the steam knob anticlockwise for at least one turn (fig. 15). The frothed milk from the tube will flow into the cup. Continue until half the milk has been emptied from the tank, then shut off the steam by rotating the knob clockwise. **When using small cups, to avoid splashes of milk, fit the splash hood onto the milk tube (fig. 16).**
- 7 Repeat the operation for the number of cups required until sufficient milk is in the cups.
- 8 After preparing the last cappuccino, before turning the appliance off, lift the intake tube in the container above the level of any milk left as shown in fig. 17 and rotate the steam knob anticlockwise. Allow the steam to discharge for a few seconds, then close the knob with the tube extracted. For hygiene reasons, this operation should always be performed to avoid stale milk remaining in the circuits of the appliance.
- 9 Finally, to avoid the milk solidifying, the milk container should be washed immediately as described below in the "Cleaning the milk frother" paragraph.



Coffee Maker EC9

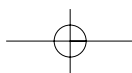

Hints

Making good espresso and cappuccino is not difficult however it does require practice. The following tips will help you get the best results from your machine:

- Warm the cups before filling with coffee.
- Use an espresso coffee for best results.
- Freshly ground coffee provides the best flavour. To maintain flavour, fresh coffee is best stored in an airtight container in a cool place, even in the fridge.

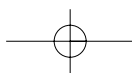
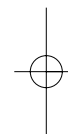
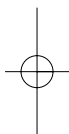

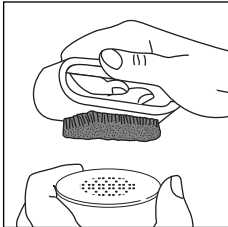

fig. 18

Cleaning the filter holder

About every 300 coffees, clean the filter holder for ground coffee as follows:

- Remove the filter
- Clean the inside of the filter holder. Never wash in a dishwasher.
- Rinse all components and clean the metal filter thoroughly in hot water using a brush (fig. 18). Make sure the holes in the metal filter are not blocked. If necessary, clean with a pin (fig. 19).

Failure to clean as described above invalidates the guarantee.

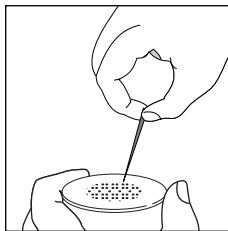

fig. 19

Cleaning the espresso boiler outlet

About every 300 coffees, the espresso boiler outlet must be cleaned as follows:

- check that the coffee machine is not warm and unplug from the mains;
- using a screwdriver, unscrew the two screws that hold the outlet of the espresso boiler (fig. 20);
- clean the boiler with a damp cloth (fig. 21);
- clean the outlet thoroughly in hot water using a brush. Make sure the holes are not blocked. If necessary, clean with a pin.
- rinse the outlet under the tap, still scrubbing it;
- replace the outlet of the espresso boiler ensuring the screws are replaced firmly.

Failure to clean as described above invalidates the guarantee.

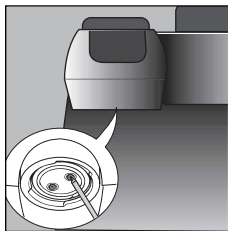

fig. 20

Cleaning the milk frother

IMPORTANT: the milk frother must be cleaned each time you use it.

Proceed as follows:

- Remove the milk container by pressing the "PRESS" lever and at the same time pulling upwards: wash with hot water.
- Remove the red frother by pressing on the clip (A) and at the same time pulling upwards (fig. 22). Remove the rubber mixer, wash and clean with hot water, particularly the four holes indicated in figure 23 (use a needle). Make sure the hole indicated with the arrow B is not blocked.

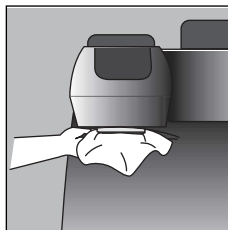

fig. 21

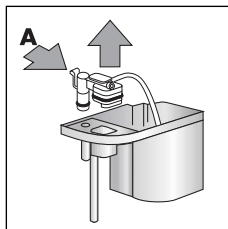

fig. 22

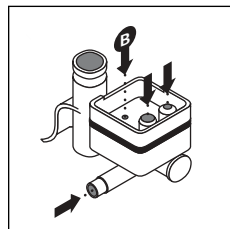

fig. 23



Coffee Maker EC9

- Once clean, all elements must be replaced correctly. In particular, make sure the rubber mixer is inserted completely and that the red frother is pushed in fully until it clicks into place. If you do not clean the tube after use, milk frothing may not be successful, the milk may not be sucked up or milk may drip from the milk tube.

Descaling







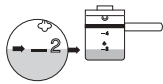

It is advisable to clean the calcium from the machine every 200 cups of coffee. It is recommended to use specific (store bought) products for descaling of espresso coffee machines. If such products are not available, the following method is recommended.

1. First clean the coffee machine, turn off and unplug from the mains.
 2. Fill the carafe to the brim with water.
 3. Dissolve 1 spoonful (about 10/15 g) of citric acid in the water.
 4. Pour the solution into the boiler.
 5. Replace the boiler cap and leave the solution to work for about 30 minutes.
 6. Place the selector in the "LIGHT" position..
 7. Check that the filter holder is not attached and place the carafe without the lid on the drip tray under the boiler outlet.
 8. Plug the appliance into the mains.
 9. Turn the coffee machine on. After a few minutes, the hot solution will start to flow through the boiler outlet into the carafe.
 10. Place the steam tube in a glass or cup. Open the steam knob for a few seconds while the descaling solution flows through the milk frother. This cleans all residue of milk from inside the milk frother and the tube.
 11. Close the steam knob (the descaling solution will continue to flow into the carafe).
 12. When the solution stops flowing into the carafe, turn off and allow the machine to cool down.
Rinse the carafe, the milk frother and milk container with hot water.
 13. To remove traces of the solution, perform at least 2 coffee-making cycles without coffee.
- Failure to clean as described above invalidates the guarantee.

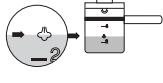
Safety Warnings

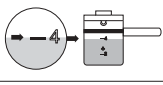
- This appliance is designed to make coffee. Take care during use to avoid burns caused by sprays of hot water or steam and avoid any improper use
- When the appliance is in use, do not touch any of the machine's hot surfaces.
- After unpacking, make sure that the machine is complete and undamaged. In case of doubt, do not use the appliance and seek the advice of a qualified service professional.
- Packaging materials (plastic bags, foam polystyrene, etc.) should not be left within the reach of children as this could be a potential source of danger.
- This appliance is to be used for domestic use only. Any other use is to be considered improper and therefore, dangerous.
- The manufacturer takes no responsibility for damage derived from improper use.
- Never touch the appliance with wet or damp hands.
- Never allow the appliance to be used by children or unfit persons.
- Do not allow children to play with the appliance.
- In the event of breakdown or malfunctioning, turn the appliance off immediately and do not touch. For repairs, please contact a Service Centre authorized by the manufacturer. Failure to observe the above points may affect the safe use of the appliance.
- The power cable must never be replaced by the user. If the cable should become damaged, or needs to be replaced, please contact a Service Centre authorized by the manufacturer.
- When the appliance is not in use, turn off and disconnect the plug from the socket.
- As with any electrical appliance, whilst the instructions aim to cover as many eventualities as possible, caution and common sense should be applied when operating your appliance, particularly in the vicinity of young children.

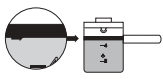
Table

To make	Water quantity in the carafe	Coffee quantity in the filter
2 espressos		
2 cappuccinos	Water level must coincide with steam symbol on the carafe 	
4 espressos		
4 cappuccinos	Water level must coincide with the bottom part of the metal band 	

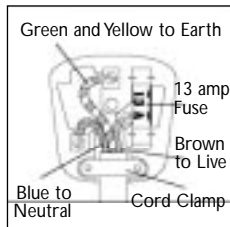

Electrical requirements

Before using this appliance ensure that the voltage indicated on the product corresponds with the main voltage in your home, if you are in any doubt about your supply contact your local electricity company.

The flexible mains lead is supplied connected to a B.S. 1363 fused plug having a fuse of 13 amp capacity. Should this plug not fit the socket outlets in your home, it should be cut off and replaced with a suitable plug, following the procedure outlined below.

Note: Such a plug cannot be used for any other appliance and should therefore be properly disposed of and not left where children might find it and plug it into a supply socket - with the obvious consequent danger.

N.B. We recommend the use of good quality plugs and wall sockets that can be switched off when the machine is not in use.

important: the wires in the mains lead fitted to this appliance are coloured in accordance with the following code:

GREEN AND YELLOW	EARTH
BLUE	NEUTRAL
BROWN	LIVE

As the colours of the wires in the mains lead of this appliance may not correspond with the coloured markings identifying the terminals in your plug, proceed as follows:

The wire which is coloured green and yellow must be connected to the terminal in the plug which is marked with the letter E or by the earth symbol \perp or coloured green or green and yellow.

The wire which is coloured blue must be connected to the terminal which is marked with the letter N or coloured black.

The wire which is coloured brown must be connected to the terminal which is marked with the letter L or coloured red.

When wiring the plug, ensure that all strands of wire are securely retained in each terminal. Do not forget to tighten the mains lead clamp on the plug. If your electricity supply point has only two pin socket outlets, or if you are in doubt, consult a qualified electrician.

Should the mains lead ever require replacement, it is essential that this operation be carried out by a qualified electrician and should only be replaced with a flexible cord of the same size.

After replacement of a fuse in the plug, the fuse cover must be refitted. If the fuse cover is lost, the plug must not be used until a replacement cover is obtained. The colour of the correct replacement fuse cover is that of the coloured insert in the base of the fuse recess or elsewhere on the plug. Always state this colour when ordering a replacement fuse cover.

Only 13amp replacement fuses which are approved to B.S. 1362 should be fitted.

This appliance conforms to the Norms EN 55014 regarding the suppression of radio interference.

Warning - this appliance must be earthed

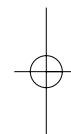
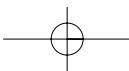

5732126800/07.03

