

Godox

微距LED环形灯
Macro LED Ring Light

RING72

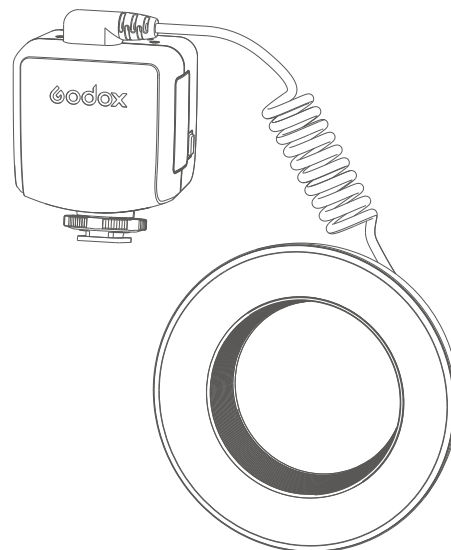

合格证
QC PASS

深圳市神牛摄影器材有限公司

地址: 深圳市宝安区福海街道塘尾社区耀川工业区厂房2栋

电话: 0755-29609320(8062) 传真: 0755-25723423 邮箱: godox@godox.com

GODOX Photo Equipment Co., Ltd.

Add: Building 2, Yaochuan Industrial Zone, Tangwei Community, Fuhai Street, Bao'an District,

Shenzhen, China Tel: +86-755-29609320(8062) Fax: +86-755-25723423 E-mail: godox@godox.com

godox.com

Made in China



说明手册
Instruction Manual

前言

请先仔细阅读本手册，以确保您能正确操作及使用。

请保存好说明手册以备将来查询。

感谢您购买神牛产品！

RING72 一款小型环形灯，精简轻便。其环形灯头可安装在相机镜头上，控制器可安装在相机热靴上；通过调节控制器的按键和旋钮，可实现单独调节L左灯/R右灯亮度，精准获取所需亮度。适用于人像拍摄、饰品拍摄、昆虫植物拍摄、口腔牙科拍摄等。轻巧时尚，操作便捷。

产品优势

- 选用72颗优质灯珠，光线充足，亮度高。
- 环形灯体安装方便，灵活性高，适用于49mm-82mm口径的相机镜头。
(82mm适配环需另购)
- 双按键双旋钮，轻松实现单独调节L左灯/R右灯亮度。
- 环形灯头小巧轻便，外观简洁，触感舒适可人。

⚠ 注意事项

- ⚠ 使用时需小心，避免发生碰撞或跌落。
- ⚠ 请勿在温度过高或过低以及潮湿的环境下使用此灯。
- ⚠ 请勿使用稀释剂、苯或其他清洁剂擦洗产品上的污渍或指印。
可使用柔软加湿布料进行擦拭清洁。
- ⚠ 如长时间不使用，建议储存在干燥、阴凉、通风良好的地方。

部件名称

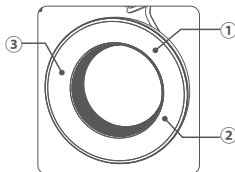
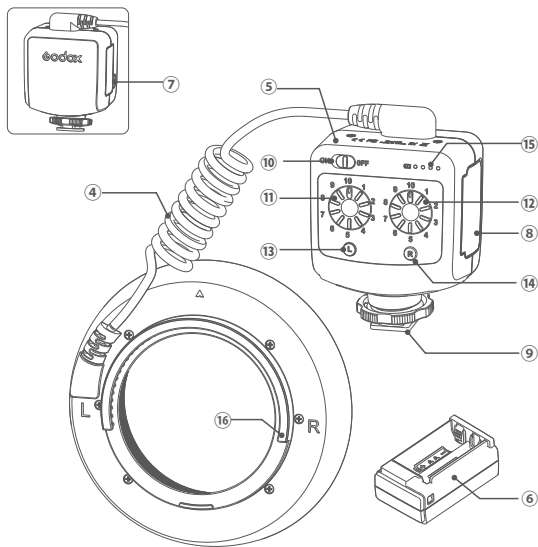

- | | |
|-----------|----------------|
| 01. 灯头 | 09. 冷靴 |
| 02. L左灯 | 10. ON/OFF电源开关 |
| 03. R右灯 | 11. 左调节旋钮 |
| 04. 连接线 | 12. 右调节旋钮 |
| 05. 控制器主体 | 13. L左灯按键 |
| 06. 电池盒 | 14. R右灯按键 |
| 07. 取电池按钮 | 15. 电量指示灯 |
| 08. 电池挡板 | 16. 适配环连接口 |

标配物品

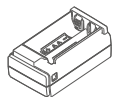

AA电池盒 *1

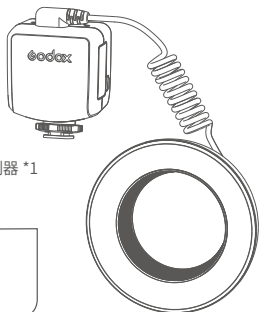

控制器 *1

灯体 *1



镜头适配环(8种规格

49mm、52mm、55mm、
58mm、62mm、67mm、
72mm、77mm)



说明书 *1

电源

此微距LED环形灯可使用电源有2种:

- 4节高容量碱性干电池或可充电镍氢电池。
- 7.2V/2600mAh 锂电池，支持反复充放电450次，使用寿命长。

注：控制器所需的高容量5号AA碱性干电池或可充电镍氢电池或锂电池，皆需另购。

RING72 通用神牛V1锂电池VB26和神牛AD100Pro锂电池WB100(7.2V/2600mAh或7.2V/3200mAh)。

使用AA碱性干电池注意事项

- 1.使用前将电池连接端擦净，以保持良好接触。
- 2.为避免电池出现爆炸、液体泄漏或过热情况，请使用4节同一品牌型号的新AA电池，请勿将不同型号电池或新旧电池混合使用。
- 3.请勿拆开、短接电池或将其置于火中或水中，以免发生爆炸。
- 4.如果长时间不使用此灯，应将电池取出电池槽。

使用锂电池注意事项

- 1.避免正负极短路。
- 2.电池没有防水功能，请勿将电池浸泡在雾、水中。
- 3.为了安全起见，请将此灯放置于儿童不易接触的地方。
- 4.建议电池充电放置最好不要超过24小时。
- 5.建议电池放置于凉爽、干燥及通风的地方存储。
- 6.请勿将电池靠近和放置于火中。
- 7.电池使用报废后请按当地的规定进行处理。
- 8.如果电池超过3个月不使用，请对电池进行充电。
- 9.长期不使用，请充电至60%左右再放置。
- 10.反复充放电450次以上或电池使用3年以上，建议更换新电池。

安装教程

一 安装电池

1. 选择使用AA碱性干电池或可充电镍氢电池

- 1.1将4节电池装入电池盒。
- 1.2将装好电池的电池盒对准电池槽插入，听到“咔”声表示装到位即可。

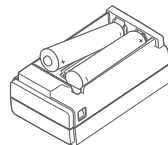

2. 选择使用锂电池

- 2.1 将锂电池对准电池槽插入，听到“咔”声表示装到位即可。

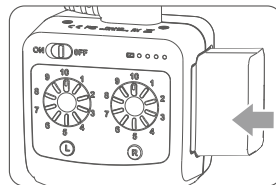

二 LED灯控制器安装到相机上教程

1. 旋转拧松固定座上的旋钮。
2. 滑动LED灯控制器固定座使其完全插入相机的热靴插座。
3. 将固定座上的旋钮旋紧，直至LED灯控制器被锁住。

注：如果要卸下LED灯控制器，先将旋钮松开再将其从相机热靴座上滑出。

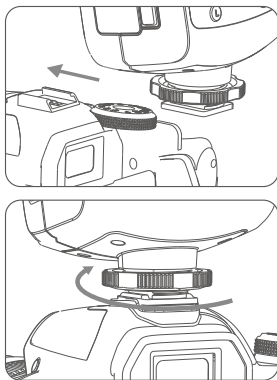

三 环形LED灯头安装到相机上教程

1. 本产品配有8种规格的适配环，与相机镜头颈圈相符：49mm、52mm、55mm、58mm、62mm、67mm、72mm和77mm。
2. 选择相应的适配环安装在相机镜头上，然后将环形LED灯头扣在适配环上。

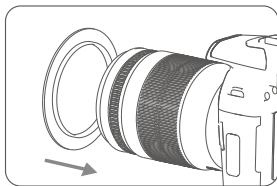

使用LED灯

1. 开机

电源开关拨至“ON”，LED灯点亮。

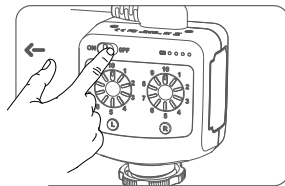

2. 控制器电量指示灯显示

亮绿灯提示剩余电量，四个亮绿灯表示剩余100%电量，三个亮绿灯表示剩余75%电量，两个亮绿灯表示剩余50%电量，一个亮绿灯表示剩余25%电量。

低电提示：当左边第一个指示灯闪烁（一秒亮一秒灭）状态，表示电池电量不足，请及时更换电池。

注：上述电量显示基于神牛测评数据，实际使用时，使用不同品牌的电池，电池指示显示会有所变化。

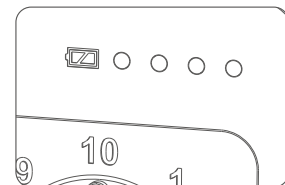

3. L左灯开关

L左灯按键亮绿色，表示L左灯打开；短按可实现关闭L左灯，再次短按可恢复之前亮度值。

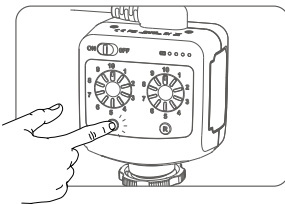

4. R右灯开关

R右灯按键亮绿色，表示R右灯打开；短按可实现关闭R右灯，再次短按可恢复之前亮度值。

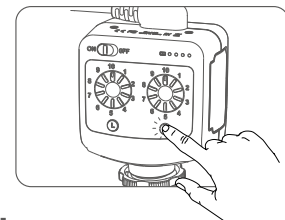

5. 左灯亮度调节

灯体开机，L左灯按键显示亮绿色，左灯打开。旋转左调节旋钮，可进行L左灯亮度调节。调光范围：10%-100%，调光档位为十档，每档以+10%单位值为增量。

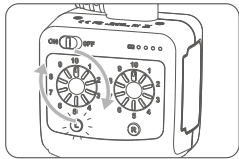

6. 右灯亮度调节

灯体开机，R右灯按键显示亮绿色，右灯打开。旋转右调节旋钮，可进行R右灯亮度调节。调光范围：10%-100%，调光档位为十档，每档以+10%单位值为增量。

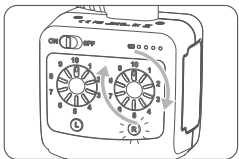

7. 左灯和右灯亮度调节

灯体开机，LR左右灯按键显示亮绿色，左右灯打开，旋转左、右调节旋钮，自由调节亮度。

注：此环形灯分为L左灯和R右灯，亮度实现单独调节，具体灯光可根据自己需求自由调节。

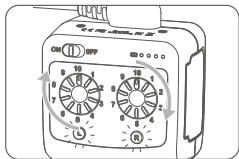

规格参数

型号	RING72	
输出功率	8W	
亮度显示	半圆环灯、圆环灯	
调光范围	10% - 100% 十档调节	
电源	大容量5号AA碱性干电池或可充电镍氢电池(另购)	1.5V*4节
	锂电池(另购)	7.2V/2600mAh
色温	5600K	
LED灯珠数量	72颗	
TLCI	≥97	
CRI	≥96	
体积	环形灯：φ132*30mm	
	控制器：84*71.5*50.5mm	
净重	245g(环形灯+控制器)(不带电池)	

* 设计和规格如有变更，恕不另行通知。

维护保养

- 在工作时，如发现异常，应立即关掉电源，查明原因。
- 灯体应避免震动，平时注意表面除尘。
- 灯体稍有发热为正常现象。
- 所有维修概由本厂指定的可供原配件的维修部负责。
- 1年保修，消耗品如灯管等，不在1年保修范围。
- 经发现，擅自检修此LED环形灯，将取消一年保修期，维修需要收取相关费用。
- 如果本品出现故障或者被水淋湿，在专业人员维修后方可继续使用。
- 如有技术更改，恕不另行通知。

Foreword

Thank you for purchasing!

RING72 is a compact and portable LED ring light, whose light body can be installed on the camera lens, and the controller can be installed on the camera hot shoe. The brightness of the L left half and the R right half can be individually adjusted to accurately obtain the required brightness by adjusting the buttons and knobs of the controller. It is ideal for portrait shooting, jewelry shooting, insects and plants shooting, and dental photography etc.

Please read this manual carefully before using to make sure the correct operation and exert the optimum function. Please keep the instruction manual for future reference.

Main Features

- Adopt 72 pieces premium LED beads ensure sufficient high-brightness light.
- Eight different adapter rings are included to fit a range of lens diameters from 49mm to 82mm (82mm adapter ring is not included).
- Separately control the brightness of the left/right half to create side-lite effects.
- Coiled cord connects the ring light to the controller to provide extra convenience.

⚠ Warning

- ⚠ Be careful while using to protect it from crashing or falling.
- ⚠ Do not use in the too high or too low temperature environment. And Do not use in rain or in damp conditions.
- ⚠ Do not use thinner, benzene or other cleaning agents to clean. It is recommended to use a soft, moisturized cloth for wiping and cleaning this product.
- ⚠ Store it in a dry, cool and well-ventilated place, if don't not use this product for long time.

Names of Parts

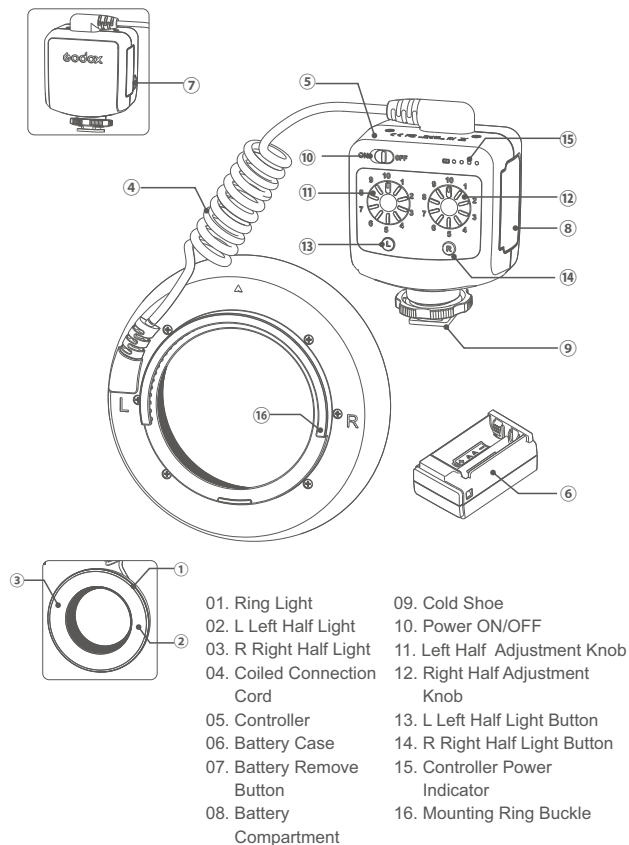

What's in the Box

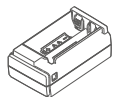

AA Battery Case *1

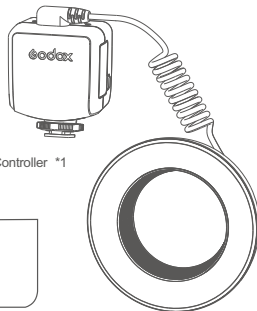

Controller *1

Ring Light *1



Adapter Rings (eight different lens diameters:
49mm, 52mm, 55mm, 58mm, 62mm,
67mm, 72mm, 77mm)



Instruction
Manual *1

Types of power supply

2 types power supply following for this macro LED ring light:

- 4 pieces size-AA large capacity alkaline batteries or 4 rechargeable Ni-MH batteries.
- 7.2V/2600mAh lithium battery supports 450 times of repeated charging and discharging, and has a long using life span.

* Note: Batteries are sold separately and you can purchase it from us Godox. 2 types Godox lithium battery(7.2V/2600mAh or 7.2V/3200mAh) following can be applied to this Ring 72.

- Godox lithium battery VB26(shared with Godox TTL Li-ion Round Head Camera Flash V1).
- Godox lithium battery WB100(shared with Godox Pocket Flash AD100Pro).

Precautions for using AA alkaline batteries

1. Keep the batteries connection clean and dry to maintain good contacts.
2. Use a new set of four batteries of the same brand. When replacing the batteries, replacing all four at one time.
3. Do not disassemble or short-circuit the batteries. And do not put aside or into fire or water.
4. Take the batteries out from the battery slot, if the light is not used for a long time.

Precautions for using lithium battery

1. Avoid short-circuiting the positive and negative poles.
2. As the batteries do not have waterproof function, please take measures of waterproof in rainy or damp environment.
3. Keep the product out of reach of children.
4. No over 24 hours' continuous charging.
5. Store in dry, cool, ventilated places.
6. Do not put the battery aside or into the fire.
7. Dead batteries should be disposed according to local regulations.
8. Please charge the battery to approx. 60% before being placed for long time.
9. If the battery had ceased using for over 3 months, please make a full recharge.
10. It's normal that the battery will be degraded after a period's usage for the battery life limitation.

Installation tutorial

Install the battery

1.1 Use AA alkaline batteries or rechargeable Ni-MH batteries

- 1.1.1 Put 4 pieces batteries into the battery case.
- 1.1.2 Align the battery case with the battery compartment, and insert the battery case into the battery compartment until it be locked with a click sound.

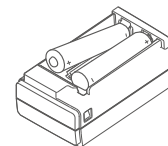

1.2. Use lithium battery(Lithium battery is not included and you can purchase it separately)

- 1.2.1 Align the battery with the battery compartment, and insert the battery into the battery compartment until it be locked with a click sound.

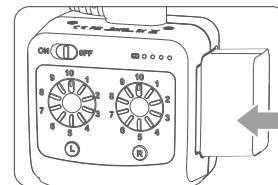

How to install the LED light controller on the camera

2.1 Rotate and loosen the knob at the bottom of the ring light controller.

2.2 Slide the ring light controller base mount and insert it into the hot shoe socket of the camera.

2.3 Tighten the knob at the bottom of the controller until it is completely fixed.

Note: If you remove the LED light controller, first loosen the knob and then slide it out of the camera hot shoe.

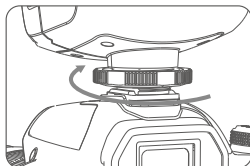
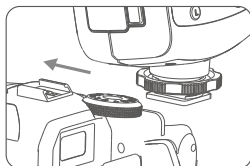

How to install the ring LED head on the camera

3.1 This product is equipped with 8 different types of adapter rings, which can fully match the camera diameter of: 49mm, 52mm, 55mm, 58mm, 62mm, 67 mm, 72mm and 77mm.

3.2 Choose the corresponding adapter ring and install it on the camera lens, and then buckle the ring LED head on the adapter ring.

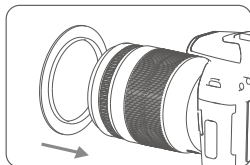

Use LED lights

1. Turn on

Slide the power switch to "ON" and the LED light will light up.

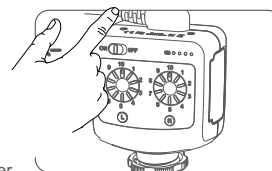

2. Controller power indicator display

The green light indicates the remaining power, the four green lights indicate the remaining 100% power, the three green lights indicate the remaining 75% power, the two bright green lights indicate the remaining 50% power, and the one green light indicates the remaining 25% power.

Low battery reminder: When the first indicator on the left flashes (on for one second and off for one second), it indicates that the battery is low. Please replace the battery in time.

Note: The above power display is based on the testing data of Godox. Different brands of batteries will cause the battery indicator display to be different.

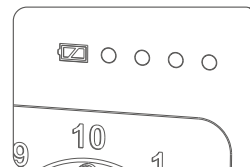

3. L left half ON/OFF

L left half light button lights up green, indicating that the L left half light is turned on; short press can turn off the L left half light, short press again to restore the previous brightness value.

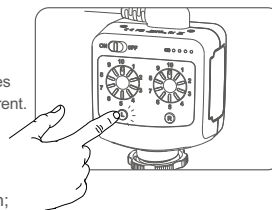

4. R right half ON/OFF

The R right half light button lights up green, indicating that the R right half light is on; short press can turn off the R right half light, and short press again to restore the previous brightness value.

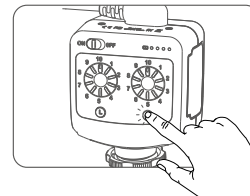

5. Left half brightness adjustment

Power on ring light, L left half light button lights up green indicating the L left half brightness is on, turn the left half adjustment knob to adjust the brightness of the L left half light.

Adjustment range: 10%-100%, 10 levels to switch, and each level is incremented by +10%.

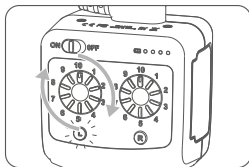

6. Right half brightness adjustment

Power on ring light, R right half light button lights up green indicating the R right half brightness is on, turn the right half adjustment knob to adjust the brightness of the R right half light.

Adjustment range: 10%-100%, 10 levels to switch, and each level is incremented by +10%.

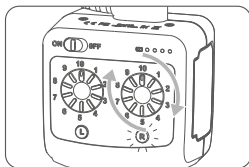

7. Left half and Right half brightness adjustment

Power on ring light, the L and R half light buttons light up green indicating both the left and the right half light brightness are on. And then switch the Left half adjustment knob and the Right half adjustment knob to set their brightness freely.

Note: This ring light is divided into L left half light and R right half light. The L and R rights' brightness can be adjusted separately according to user specific needs.

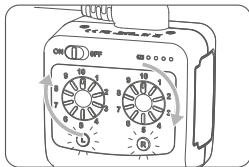

Technical Data

Model	RING72	
Output Power	8W	
Brightness Display	Separate control on the left / right half	
Dimming Range	10% - 100% adjustment in 10 levels	
Power Supply	AA Size large capacity alkaline battery or rechargeable Ni-MH battery (sold separately)	1.5V*4 pieces
	Lithium Battery (sold separately)	7.2V/2600mAh
Color Temperature	5600K	
Number Of LED Lamp Beads	72 pcs	
TLCI	≥97	
CRI	≥96	
Volume	Ring Light: $\phi 132*30$ mm	
	Controller: $84*71.5*50.5$ mm	
Net Weight	245g (ring light+controller) (battery not included)	

* Product design and specifications are subject to change without notice.

Maintenance

- When the flash is working, if an abnormality is found, the power should be turned off immediately to find out the cause.
- The lamp body should avoid vibration, and always pay attention to dust removal on the surface.
- It is normal that the lamp body is slightly hot. Do not flash continuously when there is no special need.
- All repairs are handled by the repair department designated by the factory for original parts.
- One year warranty, consumables such as lamps are not covered by one year warranty.
- All maintenance shall be handled by the maintenance department designated by the factory.
- If this product breaks down or gets wet, it can be used only after professional repairs.
- Subject to technical changes without notice.

FCC Statement

This device complies with part 15 of the FCC Rules. Operation is subject to the following two conditions: (1) This device may not cause harmful interference, and (2) this device must accept any interference received, including interference that may cause undesired operation.

Note: This equipment has been tested and found to comply with the limits for a Class B digital device, pursuant to part 15 of the FCC Rules. These limits are designed to provide reasonable protection against harmful interference in a residential installation. This equipment generates uses and can radiate radio frequency energy and, if not installed and used in accordance with the instructions, may cause harmful interference to radio communications. However, there is no guarantee that interference will not occur in a particular installation. If this equipment does cause harmful interference to radio or television reception, which can be determined by turning the equipment off and on, the user is encouraged to try to correct the interference by one or more of the following measures:

- Reorient or relocate the receiving antenna.
- Increase the separation between the equipment and receiver.
- Connect the equipment into an outlet on a circuit different from that to which the receiver is connected.
- Consult the dealer or an experienced radio/TV technician for help.

产品保修

尊敬的用户，本保修卡是申请保修服务的重要凭证，请您配合销售商填写并妥善保管，谢谢！

产品信息	型号	产品条码
用户信息	姓名	联系电话
	通信地址	
销售商信息	名称	
	联系电话	
	通信地址	
	销售日期	
备注		

注：此表应由销售商盖章确认。

适用产品

本文件适用于相关《产品保修信息》(见后面说明)所列产品，其他非属此范围的产品或部件(如促销品、赠品及其他出厂后附加的部件等)不在此保修承诺内。

保修期

产品及部件的相应保修期按相关的《产品保修信息》执行。保修期自产品首次购买日起算，购买日以购买产品时保修卡登记日期为准。

如何获得保修服务

您可直接与产品销售商或授权服务机构联系，也可拨打神牛产品售后服务电话，与我们联系，由我们的服务人员为您安排服务。申请保修时，您应提供有效的保修卡作为保修凭证，方可获得保修。如您不能提供有效的保修卡，则在我们确认产品或部件属于保修范围的情况下，也可以为您提供保修，但这不作为我们的义务。

不适用保修的情况

如产品存在下列情况，本文件项下的保证和服务将不适用 ①产品或部件超过相应保修期；②错误或不当使用、维护或保管导致的故障或损坏，如：不当搬运；非按产品合理预期用途使用；不当插拔外接设备；跌落或外力挤压；接触或暴露于不适当温度、溶剂、酸碱、水浸或潮湿环境；③由非神牛授权机构或人员安装、修理、更改、添加或拆卸造成的故障或损坏；④产品或部件原有识别信息被修改变更或删除；⑤无有效保修卡；⑥使用非合法授权、非标准或非公开发行的软件造成的故障或损坏；⑦因不可抗力或意外事件造成的故障或损坏；⑧其他非因产品本身质量问题导致的故障或损坏。遇上述情况，您应向相关责任方寻求解决，神牛对此不承担任何责任。因非在保修期或保修范围内的部件、附件或软件导致产品不能正常使用的，不是保修范围内的故障。产品使用过程中正常的脱色，磨损和消耗，不是保修范围内的故障。

产品保修和服务支持信息

产品的保修期和服务类型按以下《产品保修信息》执行：

产品类别	选项名称	保修期(月)	保修服务类型
部件	电路板	12	客户送修
	电池	3	客户送修
	充电器、电源线，同步线等带电性能的部件。	12	客户送修
其他	如闪光管、造型灯泡、外壳、保护罩、锁紧装置、包装等。	无	无保修

神牛产品售后服务电话 0755-29609320-8062

Warranty

Dear customers, as this warranty card is an important certificate to apply for our maintenance service, please fill in the following form in coordination with the seller and safe-keep it. Thank you!

Product Information	Model	Product Code Number
Customer Information	Name	Contact Number
	Address	
Seller Information	Name	
	Contact Number	
	Address	
	Date of Sale	
Note:		

Note: This form shall be sealed by the seller.

Applicable Products

The document applies to the products listed on the **Product Maintenance Information** (see below for further information). Other products or accessories (e.g. promotional items, giveaways and additional accessories attached, etc.) are not included in this warranty scope.

Warranty Period

The warranty period of products and accessories is implemented according to the relevant Product Maintenance Information. The warranty period is calculated from the day (purchase date) when the product is bought for the first time. And the purchase date is considered as the date registered on the warranty card when buying the product.

How to Get the Maintenance Service

If maintenance service is needed, you can directly contact the product distributor or authorized service institutions. You can also contact the Godox after-sale service call and we will offer you service. When applying for maintenance service, you should provide valid warranty card. If you cannot provide valid warranty card, we may offer you maintenance service once confirmed that the product or accessory is involved in the maintenance scope, but that shall not be considered as our obligation.

Inapplicable Cases

The guarantee and service offered by this document are not applicable in the following cases: ①. **The product or accessory has expired its warranty period;** ②. **Breakage or damage caused by inappropriate usage, maintenance or preservation, such as improper packing, improper usage, improper plugging in/out external equipment, falling off or squeezing by external force, contacting or exposing to the improper temperature, solvent, acid, base, flooding and damp environments, etc;** ③. **Breakage or damage caused by non-authorized institution or staff in the process of installation, maintenance, alternation, addition and detachment;** ④. **The original identifying information of product or accessory is modified, alternated, or removed;** ⑤. **No valid warranty card;** ⑥. **Breakage or damage caused by using illegally authorized, nonstandard or non-public released software;** ⑦. **Breakage or damage caused by force majeure or accident;** ⑧. **Breakage or damage that could not be attributed to the product itself.** Once met these situations above, you should seek solutions from the related responsible parties and Godox assumes no responsibility. The damage caused by parts, accessories and software that beyond the warranty period or scope is not included in our maintenance scope. The normal discoloration, abrasion and consumption are not the breakage within the maintenance scope.

Maintenance and Service Support Information

The warranty period and service types of products are implemented according to the following **Product Maintenance Information**:

Product Type	Name	Maintenance Period(month)	Warranty Service Type
Parts	Circuit Board	12	Customer sends the product to designated site
	Battery	3	Customer sends the product to designated site
	Electrical parts e.g. battery charger, power cord, sync cable, etc.	12	Customer sends the product to designated site
Other Items	Flash tube, modeling lamp, lamp body, lamp cover, locking device, package, etc.	No	Without warranty

Godox After-sale Service Call **0755-29609320-8062**