

705-S60000-00

Godox

LED聚光灯
Focusing LED Light

S60

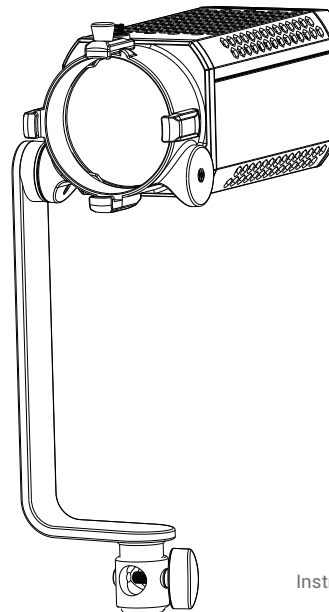

使用手册
Instruction Manual

深圳市神牛摄影器材有限公司

地址: 深圳市宝安区福海街道塘尾社区耀川工业区厂房2栋
电话: 0755-29609320(8062) 传真: 0755-25723423 邮箱: godox@godox.com

GODOX Photo Equipment Co., Ltd.

Add: Building 2, Yaochuan Industrial Zone, Tangwei Community, Fuhai Street, Bao'an District,
Shenzhen, China Tel: +86-755-29609320(8062) Fax: +86-755-25723423 E-mail: godox@godox.com

godox.com

Made in China



前言

感谢您购买神牛产品！

LED聚光灯S60光源稳定，显色性佳，灯控分离，功能强大，适用于静物拍摄、人像拍摄、采访布光以及视频拍摄等。可以精细调节亮度，附件丰富，操作简便。

主要特点：

- 专门设计镜片，光效柔和，中心、边缘光效输出均匀，得到最佳的拍摄效果
- 可变焦，能看到投影的硬度、大小、边缘对比度的变化
- 配合丰富附件，精确控光，打造更多创意光效
- 带有2.4G、蓝牙无线传输功能、DMX功能
- 小巧轻便，为各类场景提供可移动的光源
- 色温恒定，亮度可调
- 静音模式：零噪音，无干扰
- 灯体/控制器分离，操控更便捷，散热性更佳

警告

- △ 请勿私自拆卸产品，如产品出现故障须由本公司或授权的维修人员进行检查维修。
- △ 此机有温度保护功能，当温度过高时进入保护状态，当温度降低后恢复正常。
- △ 摄影灯采用电源插头做为断接装置，应保持随时便于操作。
- △ 本产品不能防水，在雨天及潮湿的环境下注意防水。
- △ 在不使用时，请断开电源。

部件名称

• 主机

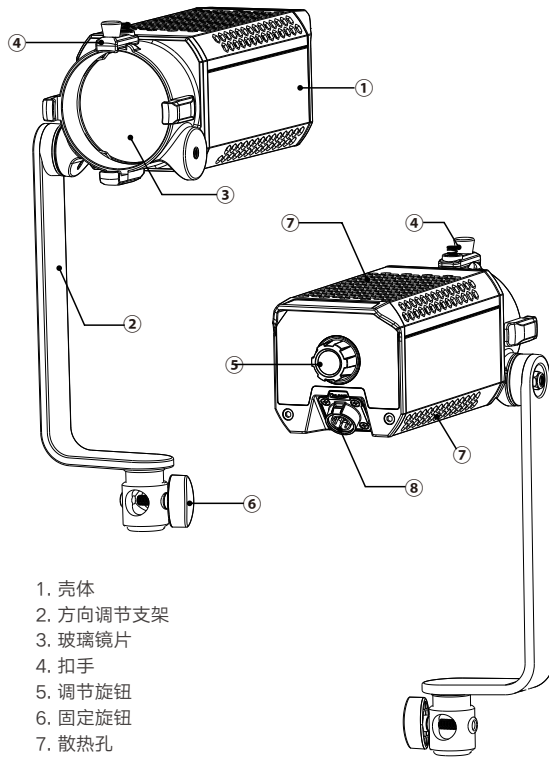

1. 壳体
2. 方向调节支架
3. 玻璃镜片
4. 扣手
5. 调节旋钮
6. 固定旋钮
7. 散热孔
8. 电源插座

• 控制盒

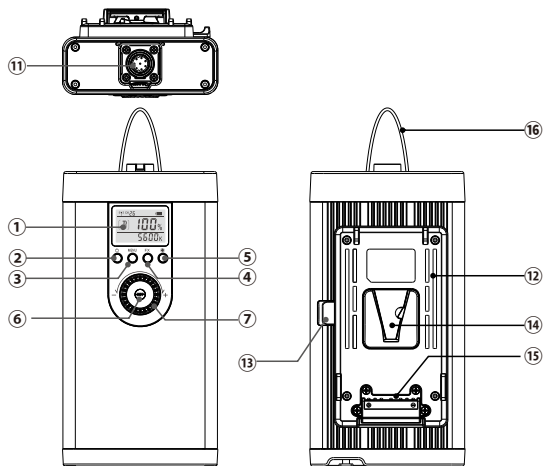

- | | |
|----------------------|----------------------|
| 1. 显示屏 | 9. DMX输出控制
接口(母插) |
| 2. 开关按键 | 10. 电源输入端 |
| 3. MENU按键 | 11. 电源输出端 |
| 4. FX按键 | 12. 电池背夹 |
| 5. 风扇开关按键 | 13. 电池推钮 |
| 6. SET按键 | 14. 电池卡座 |
| 7. +-调节拨轮 | 15. 电池触针底座 |
| 8. DMX输出控制
接口(公插) | 16. 钢丝线 |

标配物品

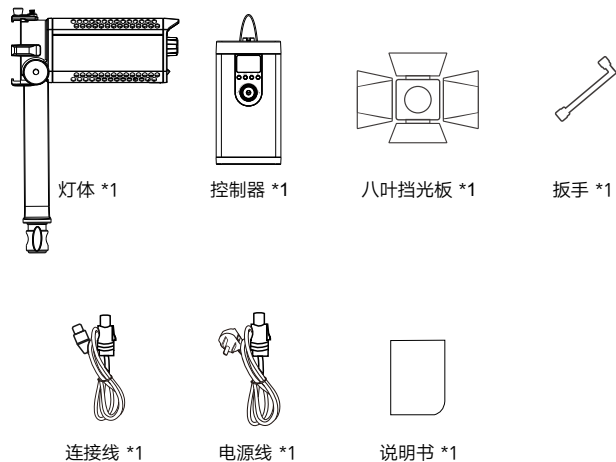

灯体 *1

控制器 *1

八叶挡光板 *1

扳手 *1

连接线 *1

电源线 *1

说明书 *1

可选购附件

可搭配本公司以下摄影附件使用，以获得最佳的拍照效果和使用体验：



SA-P投影机
(包含SA-01 85mm镜头)



SA-01
85mm镜头



SA-02
60mm广角镜头



SA-03
150mm长焦镜头



SA-05
减光纱网



SA-06
可调光阑



SA-07
挡光片



SA-09
投影片



SA-10
投影片座



SA-11C(色彩效果组)
SA-11T(色温调整组)
色片



RC-A6遥控器

供电方式

• 第一种：DC电源供电

1. 将电源连接线两端分别对准控制器电源输出接口和灯体电源输入接口插入，听到“咔”声表示插到位。

2. 将电源线输出端对准控制器输入接口插入，然后向右旋转15°，听到“咔”声表示装到位。电源线拔出方式：将电源线输出端的推钮往外推同时向左旋转15°拔出即可。

3. 电源线插入插座，接通电源。

连接线拔出方式：将连接线上端的弹片按压同时拔出即可。

• 第二种：V口电池(另购)供电

直接将V口电池插入控制盒电池背夹上，打开电源开关即可使用。

注：V口电池请使用标准电压为14.8V，请勿使用电压超过16.8V的电池供电。

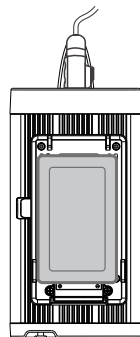
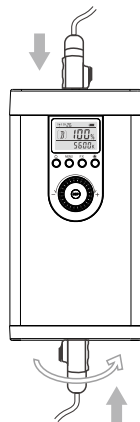

操作说明

• 开关:

短按电源开关键，LED灯亮，再短按一次LED灯熄灭。

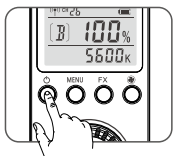

• 亮度调节:

在主界面，拨动+-调节拨轮，可进行亮度调节(0~100%)。

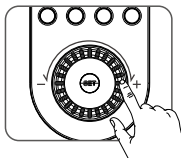

• 光效模式设置

在常态下，短按一次FX按键，进入光效模式界面，拨动+-调节拨轮可选择光效场景。FX光效模式有8种(OFF/1~8)，模拟各种拍摄场景，轻松实现创意光效。

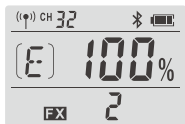



显示	FX1	FX2	FX3	FX4	FX5	FX6	FX7	FX8
场景	Flash 1	Flash 2	Flash 3	Storm 1	Storm 2	Storm 3	TV	坏灯泡

设置好后再次短按FX键或SET键退出光效模式，返回到主界面。

注：选择1~8光效场景，主界面显示FX图标及光效类型，并可调节高度，不显示色温；若选择OFF档位，主界面不显示FX图标，显示色温。

• 静音模式

在常态下，短按风扇按键, 可进行风扇开关。风扇关闭时，进入静音模式，显示屏上方出现图标，亮度可调范围为0%-50%。

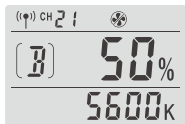

注：默认状态为风扇开启，显示屏上方无图标出现。

控制模式选择

• 1. 2.4G无线控制:

静音LED摄影灯S60具有2.4G无线接收功能，可另购遥控器RC-A6进行无线遥控，使用2.4G无线技术功能，可同时分别控制16组LED灯，32个频道，99个无线ID，抗干扰强。

注：使用前请把遥控器与LED灯的频道(CH)、组别(GR)，ID设为一致，LED灯在开机的状态下才能接收无线信号。

• CH频道调节/GR组别调节/ID值调节:

在主界面，短按一次MENU按键，再拨动+-调节拨轮可进行CH频道、GR组别、ID值进行切换调节；在CH频道界面，短按一次SET键，参数图标闪烁；然后拨动+-调节拨轮可进行频道(CH)调节(1~32)；调节好后短按SET键确认，参数图标停止闪烁。

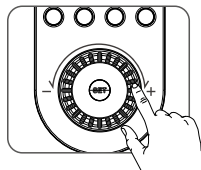
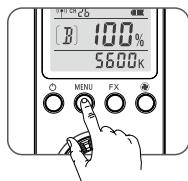

在GR组别界面，短按一次SET键，参数图标闪烁；然后拨动+-调节拨轮可进行组别(GR)调节(A-F、0-9)，调节好后短按SET键确认，参数图标停止闪烁。

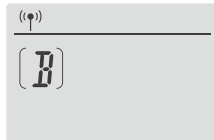

在ID界面，短按一次SET键，参数图标闪烁；然后拨动+-调节拨轮可进行ID调节(1~99 / OFF)，调节好后短按SET键确认，参数图标停止闪烁。

设置好后短按MENU键，返回到主界面。

注：10秒后无操作自动返回到主界面。



• 2. 蓝牙控制：

2.1 蓝牙编号显示&蓝牙重置功能

查看蓝牙编码：在主界面，短按一次MENU按键，再拨动+-调节拨轮切换，显示屏上方出现蓝牙符号即可见蓝牙编码。

蓝牙重置功能：在蓝牙编码界面长按SET按键2秒，蓝牙图标闪烁，可实现蓝牙重置功能。再短按MENU键，返回到主界面。

注：LED灯蓝牙默认开启状态。

首个移动设备（手机或平板电脑）可直接使用APP操控灯体。更换其他移动设备（手机或平板电脑）时，灯体进行蓝牙重置后，方可正常使用APP连接。



2.2 直接扫二维码即可下载“Godox Light”手机APP。（安卓和苹果系统都可以使用）

手机APP操作请打开APP里的“帮助”，里面有详细教程。



• 3. DMX控制设置：

在主界面，短按一次MENU按键，再拨动+-调节拨轮切换，直到显示屏下方出现DMX参数图标。短按SET键，此时参数图标闪烁，然后拨动+-调节拨轮可进行DMX通道设置(1~512)。快速调节10个单元值。调节好后短按SET键确认，参数图标停止闪烁。再短按MENU键，返回到主界面。



DMX参数表：

运行模式 地址码	CCT	FX	备注
n(模式)	0-51	52-255	
n+1	DMX*(100/255) 取整数 0-100%亮度调节	DMX*(100/255) 取整数 0-100%亮度调节	
n+2		DMX*(特效总数/255)	例如：特效总数8， DMX=160， 特效号160*8/255=5

产品参数

LED聚光灯	S60	
供电方式	AC电源供电	100~240V 50/60HZ 0.9A.MAX
	V口电池	标准电压: 14.8V (另购)
输出功率	60W	
色温	5600K±300K	
100%光照度(LUX)	散光(中心区)	3200
暗室, 1米距离(≈)	聚光(中心区)	40000
CRI	≥96	
TLCI	≥97	
调光范围	0~100%	
频道(CH)	32个 (1~32)	
组别 (GR)	16组 (A~F, 0-9)	
照射角度	6°-55°	
工作环境温度	-10~40°C	
控制方式	手机APP/2.4G无线遥控/DMX控制	
2.4G无线传输距离	50米	
产品尺寸(≈)	灯体: 264*107*100mm	
	控制盒: 268*113*64mm	
净重(≈)	灯体: 1.36kg	
	控制盒: 0.94kg	

* 设计和规格如有变更, 恕不另行通知。

维护保养

- 1年保修, 消耗品电池, 电源线, 电源连接线等配件不在此保修范围内
- 经发现, 擅自检修此补充灯的, 将取消LED灯之一年保修期, 维修需要收取相关费用。
- 对于不规范操作引起的机器故障不在保修范围内。
- 所有维修概由本厂指定可供原厂配件之维修部负责。
- 为了防止灰尘的堆积影响到产品的性能, 请定时用干净的湿布轻轻擦拭产品外部。
- 如果本品出现故障或者被水淋湿, 在专业人员维修后方可继续使用。
- 设计和规格如有变更, 恕不另行通知。

本设备包含型号核准代码为: CMIIT ID:2020DP13510, 为该产品的无线电发射模块。

Foreword

Thank you for purchasing Godox product!

Focusing LED Light S60 is excellent for product shooting, photojournalistic and video recording, etc. It creates stable light resource and even illumination for photography. This light's brightness can be precisely adjusted with easy operation.

Main Features:

- With specially designed lens to gain soft and even light effect from center to edge
- Adjustable focusing range and light brightness enable you to observe the variation of shadow's hardness, dimension and edge contrast
- Precisely control the light and achieve more creative light effects when use in combination with abundant accessories
- Three ways of power supply (5V/7.4V/15V) offer great convenience, portability and wide application

⚠ Warning

- ⚠ Do not disassemble or modify. Should the product break down, send the defective back to the authorized service center for inspection and maintenance.
- ⚠ If this product overheats, it will cease operation and resume working after cooling down. This is due to the built-in over-temperature protection.
- ⚠ As this product adopts make and break device, please keep it easy to be used.
- ⚠ Keep dry. Do not handle with wet hands, immerse in water, or expose to rain.
- ⚠ Do not place in high temperature or high humidity conditions.
- ⚠ Keep out of reach of children.
- ⚠ Disconnect from the power supply when it will not be used for an extended period.

Name of Body

• Main Body

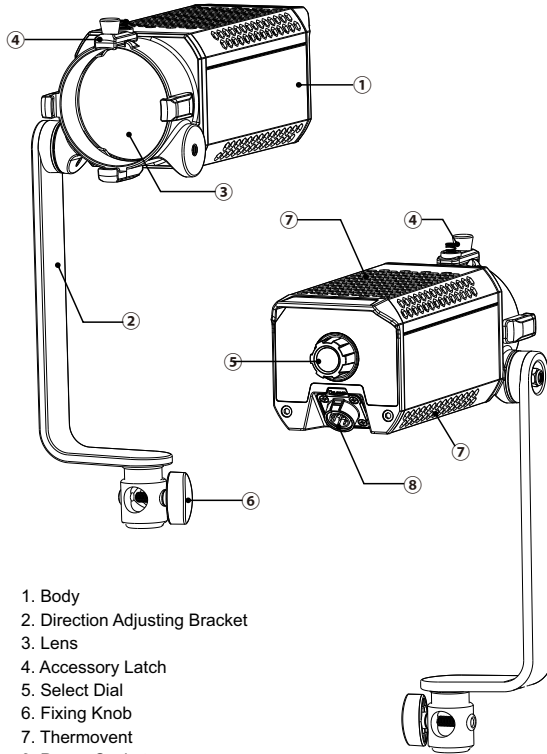

1. Body
2. Direction Adjusting Bracket
3. Lens
4. Accessory Latch
5. Select Dial
6. Fixing Knob
7. Thermovent
8. Power Socket

• Controller

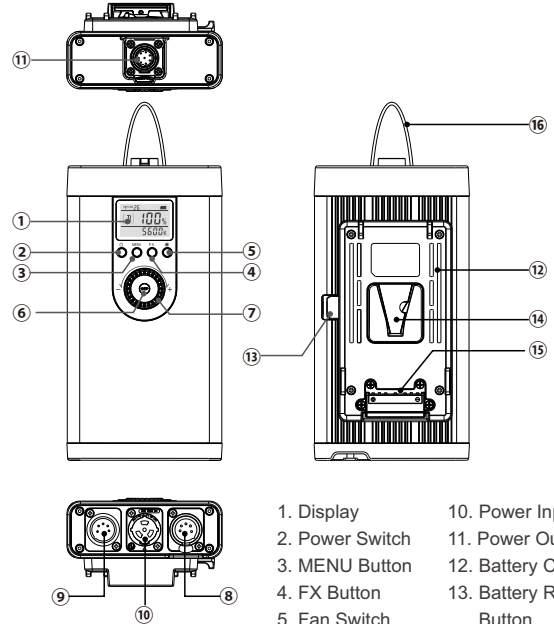

- | | |
|-----------------------------|----------------------------|
| 1. Display | 10. Power Input |
| 2. Power Switch | 11. Power Output |
| 3. MENU Button | 12. Battery Clip |
| 4. FX Button | 13. Battery Release Button |
| 5. Fan Switch | 14. Battery Compartment |
| 6. SET Button | 15. Battery Base |
| 7. + - Select Dial | 16. Steel Cable |
| 8. DMX Output Port (male) | |
| 9. DMX Output Port (female) | |

Included Items

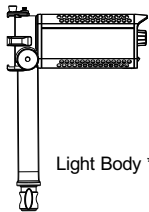

Light Body *1

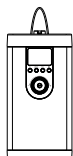

Controller *1

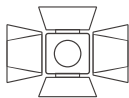

Barndoor Set *1



Wrench *1



Connect Cable *1



Power Cable *1



Instruction Manual *1

Optional Accessory

The product can be used in combination with the following accessories sold separately, so as to achieve best photography effects.



SA-P
Projection Attachment
(included a SA-01 85mm Lens)



SA-01
85mm Lens



SA-02
60mm Wide-angle
Lens



SA-03
150mm Telephoto
Lens



SA-05
Scrim Set



SA-06
Iris Diaphragm



SA-07
Framing Shutter



SA-09
GOBO Set



SA-10
GOBO Holder



SA-11C
(Color effects set)
SA-11T
(Color temperature
adjustment set)
Color Filter



RC-A6
Remote Control

Power Supply

DC Power Supply

1. Insert the two ends of power source connect cable into the controller's power output port and light's power input port until a "click" can be heard.

Pull out the connect cable: press down the PUSH button and pull out the cable simultaneously.

2. Insert the power cable's output end into the controller's input port. Then, rotate it rightwards to 15° until a "click" can be heard.

Pull out the power cable: press the PUSH button on the output end of power cable and rotate it leftwards to 15° to pull out.

3. Connect power cable into the power source.

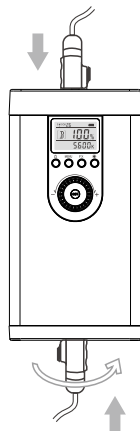

V-port Battery Power Supply (Optional)

Install the V-port battery onto the controller's battery compartment. Then, power the light on to operate.

Note: please use the standard V-port battery with 14.8V standard voltage. Do not supply power with the battery whose voltage is over 16.8V.

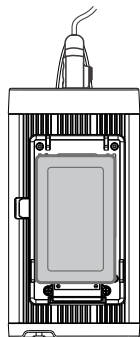

Operation

• Power switch:

Short press the power switch, and the LED light will be lighted on. Press the button again to turn off the light.

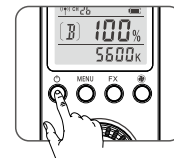

• Brightness adjustment:

In the main interface, turn the select dial to adjust brightness from 0% to 100%.

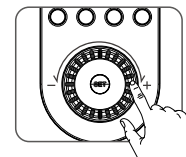

• Light effects setting:

In normal status, short press the FX button once to enter the setting interface. Then, turn the select dial to choose light effects from OFF and 1 to 8.

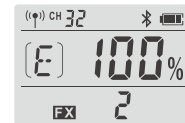

Display	FX1	FX2	FX3	FX4	FX5	FX6	FX7	FX8
Scene	Flash 1	Flash 2	Flash 3	Storm 1	Storm 2	Storm 3	TV	Broken bulb

Short press the FX button or SET button to exit from light effects modes and back to the main interface after settings finished.

Note: If a light effect is selected from 1 to 8, the FX icon and light effects will be displayed on the main interface. And the brightness can be adjusted. The color temperature will not be displayed.

If choose OFF, the color temperature will be displayed instead of FX icon.

• Silent Mode:

In normal status, short press the Fan button to turn it on or off. When turning off the fan, the LED light will enter silent mode. And the fan icon will be displayed and the brightness will be adjusted from 0% to 50%.

Note: the fan will be turned on by default and there is no icon appeared on the display.

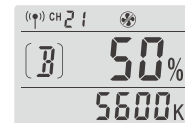

Control Mode Selection

1. 2.4G Wireless Control

With 2.4G wireless system, S60 focusing LED video light has remote grouping and control function. It is recommended to purchase RC-A6 remote control (optional) to achieve wireless control. Multiple LED lights can be controlled. 32 channels and 99 IDs are available with strong anti-interference capability.

Note:

1. Please make LED light's channel, group and ID to the same as remote control's.
2. The wireless signals can only be received in the situation that the LED light is powered on.

CH Channel Adjustment/GR Group Adjustment/ID Value Adjustment

In main interface, short press MENU button once and turn the select dial to adjust channel, group and ID values.

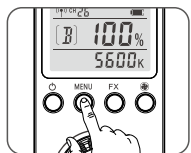

In CH channel setting interface, short press SET button and the channel icon will blink. Then, turn the select dial to choose channel from 1 to 32. Press the SET button to confirm and the icon will stop blinking.

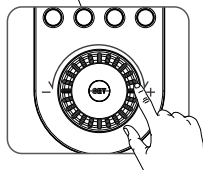

In GR channel setting interface, short press SET button and the group icon will blink. Then, turn the select dial to choose group from A to F and 0 to 9. Press the SET button to confirm and the icon will stop blinking.

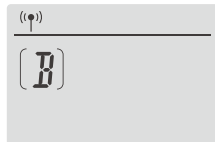

In ID channel setting interface, short press SET button and the group icon will blink. Then, turn the select dial to choose group from OFF and 1 to 99. Press the SET button to confirm and the icon will stop blinking.



After setting all these parameters, short press SET button to confirm and back to the main interface.

Note: the LED light will auto return to the main interface if there's no operation after 10 seconds.

2. Bluetooth Control

2.1 Bluetooth Code Display & RESET Function

Check Bluetooth code: in main interface, short press MENU button. Then, press the select dial to switch the icons. The Bluetooth icon will be displayed after Bluetooth icon appeared.



Bluetooth reset function: in the Bluetooth code interface, long press the SET button for 2 seconds and the Bluetooth icon will blink because of resetting. And the icon will stop blinking after successfully reset. Then, short press the MENU button to return to main interface.

Note: The LED light's Bluetooth function should be turned on. The APP can be used directly on the firstly installed device (smartphone or iPad). When change to other mobile device (smartphone or iPad), the light shall be reset before the normal connection of APP.

2.2 Scan the QR code to download the "Godox Light" smartphone APP (can be used in Android and Apple).

For more smartphone APP operations, please open the "help" in APP to gain detailed guidance.



3. DMX Control Mode

In main interface, short press MENU button once and turn the select dial to switch until the DMX icon is displayed. Short press the SET button and the icon will be blinking. Then, turn the select dial to set the DMX channel from 1 to 512. Adjustment in 10 values quickly or 1 value normally. Then, short press the SET button to confirm and the icon will stop blinking. Short press the MENU button to return to main interface.



DMX Parameters:

Operation Code	Mode	CCT	FX	Note
n	(Mode)	0-51	52-255	
n+1		DMX*(100/255) Integer 0-100% Brightness	DMX*(100/255) Integer 0-100% Brightness	
n+2			DMX*(total light effects/255)	For example: total light effects 8, DMX=160, light effects No.=160*8/255=5

Technical Data

Silent LED Video Light	S60	
Power Supply	AC Power Supply	100~240V 50/60HZ 0.9A
	V-port battery	Standard voltage: 14.8V (optional)
Output Power	60W	
Color Temperature	5600K±300K	
100% Illuminance(LUX) (1m,darkroom) (≈)	Spot(Central Area)	3200
	Flood(Central Area)	40000
CRI	≥96	
TLCI	≥97	
Brightness Range	0~100%	
Channel(CH)	32 (1 to 32)	
Group (GR)	16 (A to F/ 0 to 9)	
Beam Angle	6°-55°	
Working Environment Temperature	-10~40°C	
Control Method	Smartphone APP/2.4G wireless remote control/DMX control	
2.4G Wireless Transmission Distance(≈)	50m	
Dimension (≈)	Light body: 264*107*100mm	
	Controller: 268*113*64mm	
New weight(≈)	Light body: 1.36kg	
	Controller: 0.94kg	

* Product design and specifications are subject to change without notice.

Maintenance

This product, except consumables e.g. battery, power cable and connect cable, is supported with a one-year warranty.

Avoid sudden impacts and the product should be dedusted regularly.

Maintenance of the flash must be performed by our authorized maintenance department which can provide original accessories.

Unauthorized service will void the warranty.

If the product had failures or was wetted, do not use it until it is repaired by professionals.

Changes made to the specifications or designs may not be reflected in this manual.

FCC Statement

This device complies with part 15 of the FCC Rules. Operation is subject to the following two conditions: (1) This device may not cause harmful interference, and (2) this device must accept any interference received, including interference that may cause undesired operation.

Any Changes or modifications not expressly approved by the party responsible for compliance could void the user's authority to operate the equipment.

Note: This equipment has been tested and found to comply with the limits for a Class B digital device, pursuant to part 15 of the FCC Rules. These limits are designed to provide reasonable protection against harmful interference in a residential installation. This equipment generates uses and can radiate radio frequency energy and, if not installed and used in accordance with the instructions, may cause harmful interference to radio communications. However, there is no guarantee that interference will not occur in a particular installation. If this equipment does cause harmful interference to radio or television reception, which can be determined by turning the equipment off and on, the user is encouraged to try to correct the interference by one or more of the following measures:

- Reorient or relocate the receiving antenna.
- Increase the separation between the equipment and receiver.
- Connect the equipment into an outlet on a circuit different from that to which the receiver is connected.
- Consult the dealer or an experienced radio/TV technician for help.