

705-LC50R0-03

合格证  
QC PASS

### 深圳市神牛摄影器材有限公司

地址: 深圳市宝安区福海街道塘尾社区耀川工业区厂房2栋  
电话: 0755-29609320(8062) 传真: 0755-25723423 邮箱: godox@godox.com

### GODOX Photo Equipment Co., Ltd.

Add: Building 2, Yaochuan Industrial Zone, Tangwei Community, Fuhai Street, Bao'an District,  
Shenzhen, China Tel: +86-755-29609320(8062) Fax: +86-755-25723423  
E-mail: godox@godox.com

godox.com

Made in China



# Godox

RGB LED棒灯  
RGB LED Light Stick

## LC500R

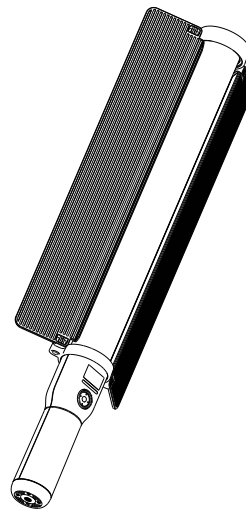

说明手册

INSTRUCTION MANUAL



## 一、前言

感谢您购买神牛产品!

RGB LED棒灯LC500R是一款高亮度、支持无线调控的常亮灯,可自由切换多种模式。适用于任何场景:直播、野外露营、自拍、静物拍摄、化妆照明、视频录播、婚纱摄影、儿童拍摄及有限空间内补光、轻松动感补光,操作便捷,轻巧便携。产品有以下亮点:

- 一灯多用,随心切换LED双色温模式、彩光模式和39种情景特效模式
- 自由调节色温、亮度、色相和色彩饱和度
- 跟随音乐跳动并变换颜色,营造多彩氛围
- 小巧显示屏,精确显示参数
- 操作简单,适用范围广泛

## ⚠警告

- ⚠ 请保持干燥:请勿用湿手接触产品,亦不可将产品浸入水中或暴露于雨中。
- ⚠ 请勿私自拆卸产品,如产品出现故障须由本公司或授权的维修人员进行检查维修。
- ⚠ 请勿让儿童接触本产品。
- ⚠ 本产品不能防水,在雨天及潮湿环境下请注意防水。
- ⚠ 请勿在化学品、可燃性气体或其他特殊物质附近使用摄影灯。在这些场合下,请注意相关警告标识。
- ⚠ 内置锂电池,禁止拆卸、撞击、挤压或投入火中,若出现严重鼓胀,请勿继续使用。请勿放置在超过40°C的高温环境中。使用专用的充电器进行充电,并且正确的按照操作说明,在规定的电压、温度范围内使用。

## 三、部件

### • 主机

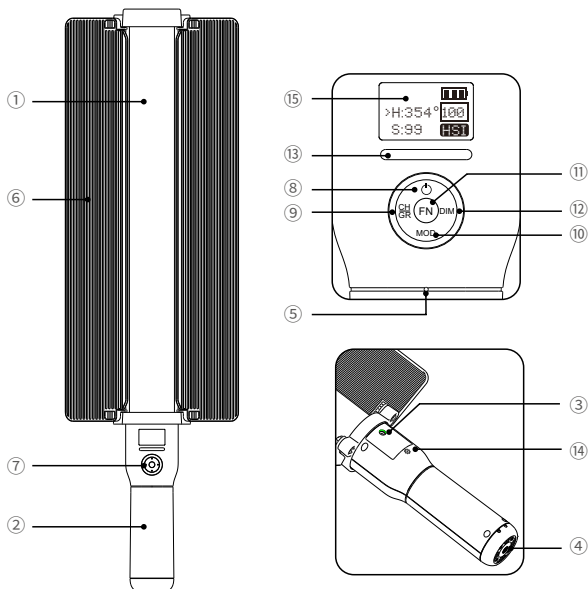

- |            |             |             |
|------------|-------------|-------------|
| 01. 灯珠     | 06. 挡光板     | 11. FN多功能按键 |
| 02. 手柄     | 07. 控制面板    | 12. DIM按键   |
| 03. DC电源插座 | 08. 开关按键    | 13. 色域      |
| 04. 支架安装孔  | 09. CH/GR按键 | 14. MIC孔    |
| 05. 复位孔    | 10. MOD按键   | 15. LCD显示屏  |

#### • LCD显示屏



显示屏上显示为CCT  
即为双色温模式。



显示HSI即为彩光模式。

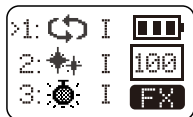

显示FX即为情景特效  
模式。

#### 四、标配物品



#### 五、电源管理

##### 1. 供电

内置大容量锂聚合物电池, 充满电最大功率100%亮度持续常亮约1.5H。

##### 2. 充电

充电时间约2.5小时, 充电时充电器指示灯为红色, 充满电指示灯为绿色。

#### 六、装卸挡光板

- 安装: 选择需要挡光的一面, 使挡板面朝这面。将挡板手柄套内部的凸槽对准手柄凹槽(见图示), 自上而下套入棒灯并推进。打开挡光板, 即可拍摄。



- 卸下: 握住手柄, 自下往上推, 即可卸下挡板。



## 七、使用说明

### 1. 灯设置

#### 1.1. 开关机

长按“”控制机子的打开和关闭，LCD显示主机当前信息。

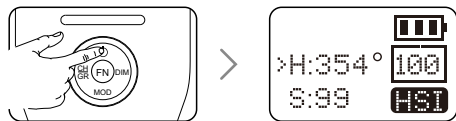

1.2 模式选择:双色温模式/彩光模式/情景模式

按MOD按钮切换模式:显示屏上显示为CCT即双色温模式,显示HSI即为彩光模式,显示FX即为情景模式。

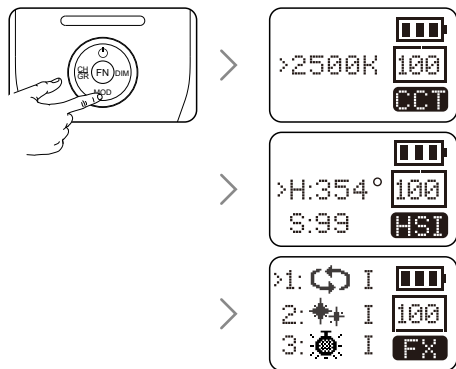

### 2.无线远程控制(遥控器另购)

本产品具备无线遥控功能,使用2.4G无线技术,无视角限制,距离远,可同时分别控制6组LED灯。16组通道频率,抗干扰强。使用前请把LED主机和遥控器的频道、组别与ID调至一致。

无线频道/组别/ID设置:按CH/GR键进入设置界面。

#### 2.1. 频道设置:

按FN选择CH然后旋转拨轮选定要设置的频道,可选频道32个(1~32)。

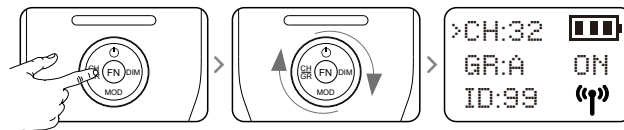

#### 2.2. 组别设置:

按FN选择GR然后旋转拨轮选定要设置的组别,可选组别6组(A~F)。

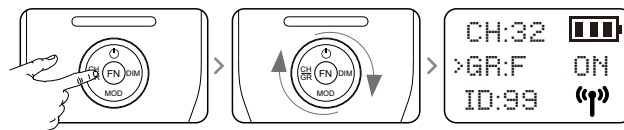

#### 2.3. ID设置:

按FN选择ID然后旋转拨轮选定要设置的ID,可选ID 99个(1~99)。

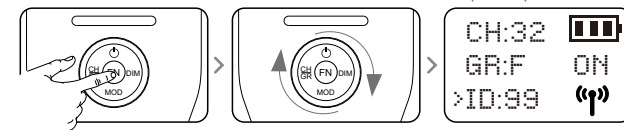

#### 2.4. 开关无线:

按FN选择“无线符号”然后旋转拨轮选择ON打开无线,选择OFF关闭无线。

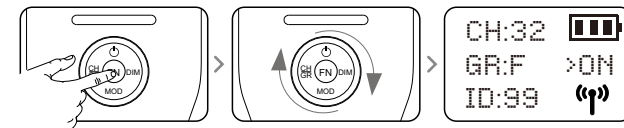

### 3. 双色温模式

3.1 色温调节: 直接旋转拨轮调节, 调节范围2500K~8500K。

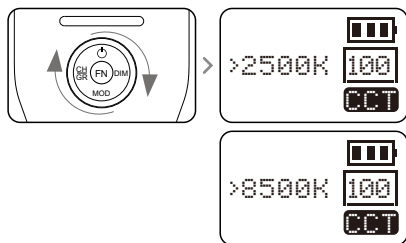

3.2 亮度调节: 按DIM按钮, 亮度值闪烁后旋转拨轮调节, 调节范围0~100%。

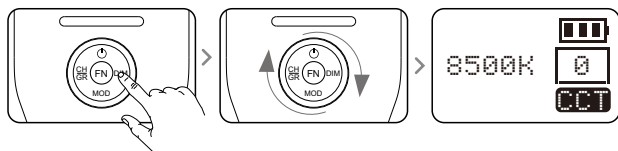

3.3 P模式: 按FN按钮, 显示屏显示P为P模式。P模式时, 调节色温时亮度也跟着变化, 当色温在4500K时, 亮度达到最大。普通模式, 调节色温时亮度基本一样。

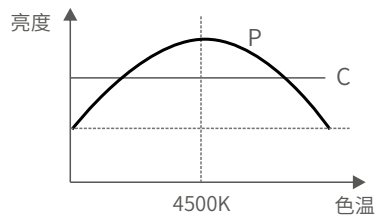

### 4. 彩光模式

按MOD按键, 进入设置界面。

4.1 调节色相H: 按多功能按键FN选中H, 再旋转拨轮调节色相, 色相调节范围0~360°。

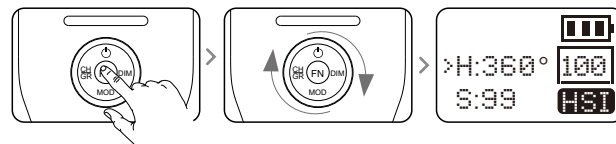

4.2 调节饱和度S: 按多功能按键FN选中S, 再旋转拨轮调节饱和度, 饱和度调节范围0-100。

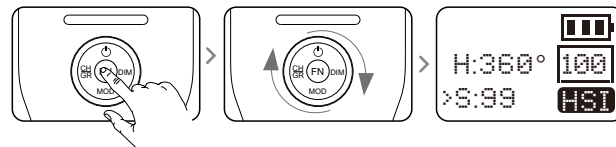

4.3 亮度调节: 按DIM后旋转拨轮调节, 调节范围0~100%。

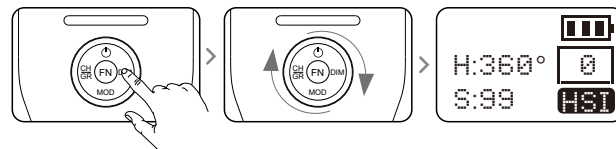

## 5. 情景特效模式(39种)

5.1 拨动拨轮选择特效模式类别, 1~14类可选, 拨动拨轮循环出现。



5.2 选中后, 按多功能按键FN可选择当前类别中的模式: I、II、III 3种模式, 按多功能按键FN循环出现。

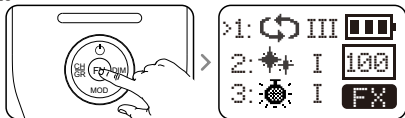

5.3 亮度调节: 按DIM后旋转拨轮调节, 调节范围0~100%。

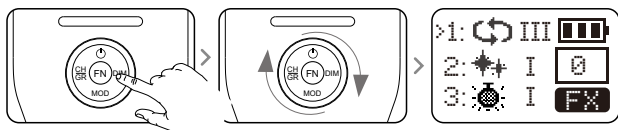

5.4 情景特效模式有14类共39种: 可根据需求选择。

序号	显示	场景	显示 I	显示 II	显示 III
1		彩光循环	慢速	中速	快速
2		闪光灯	闪光	发布会	狗仔队
3		激光彩灯	生日会	KTV	迪斯科
4		雷闪电	间歇	频繁	持续
5		坏灯泡	间歇	频繁	持续
6		电视机	慢速	中速	快速
7		蜡烛	间歇	频繁	持续
8		火	柴火	篝火	火灾
9		烟花	短暂	连续	演出
10		警车	暴闪	频闪	快闪
11		消防车	暴闪	频闪	快闪
12		救护车	暴闪	频闪	快闪
13		音乐	音乐 I	音乐 II	
14		SOS			

## 九、产品参数

LED棒灯型号	LC500R
内置锂电池供电	14.4V/2600mAh锂电池
功率	最大23W
频道	32个
组别	6组(A B C D E F)
色温范围	2500K~8500K
调光范围	0%~100%
RGB色域	0~360°
100%光照度(LUX)	最大5800
CRI(≈)	96
TLCI(≈)	98
持续使用时间(100%功率连续输出)(≈)	90分钟
工作环境温度	-10~40°C
产品尺寸(不含挡光板)	616*56*56mm
重量(不含挡光板)	0.81Kg

\* 设计和规格如有变更, 恕不另行通知。

## Foreword

Thank you for purchasing this Godox Product!

This RGB LED Light Stick LC500R is a continuous light with high light brightness, wireless adjustment and multiple modes. Suitable for almost all shooting occasions e.g. live, camping, make up, portrait shooting, make up, video, wedding, children photography, etc. It's portable and easy to be operated.

### Features:

- Freely switch LED bicolor mode, colorful light mode and 39 situational special effects modes
- Easy to adjust color temperature, light brightness, hue and color saturation
- Blink and change colors with the rhythm of music
- With a display to clearly show the parameters
- With easy operation and wide application

## ⚠ Warning

- ⚠ Always keep this product dry. Do not use in rain or in damp conditions.
- ⚠ Do not disassemble. Should repairs become necessary, this product must be sent to an authorized maintenance center.
- ⚠ Keep out of reach of children.
- ⚠ As this product do not have waterproof function, please take measures of waterproof in rainy or damp environment.
- ⚠ Do not use the flash unit in the presence of flammable gases, chemicals and other similar materials. In certain circumstance, these materials may be sensitive to the strong light emitting from this flash unit and fire or electromagnetic interference may result.
- ⚠ As this product has built-in lithium battery, do not disassemble, impact, squeeze or put it into fire. If serious bulge occurs, please do not use. Do not use or store the product if the ambient temperature reads over 50°C. Please charge the product with specialized charger and correctly operate it within the defined voltage and working temperate according to the instruction manual.

## Parts

### • Body

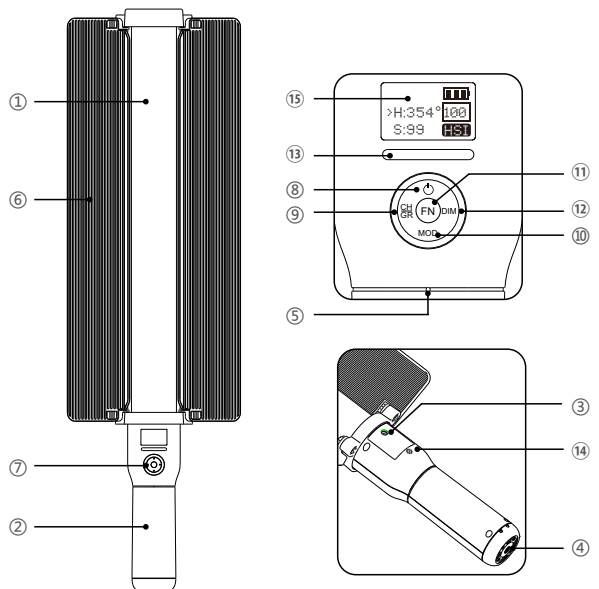

- 01. LED Beads
- 02. Handle
- 03. DC Power Jack
- 04. Bracket Mounting Hole
- 05. Reset Button

- 06. Reflector
- 07. Control Panel
- 08. Power Switch
- 09. CH/GR Button
- 10. MOD Button

- 11. FN Multifunctional Select Dial
- 12. DIM Button
- 13. Color Gamut
- 14. MIC Hole
- 15. LCD Panel

## • LCD Panel



CCT: Bicolor Modes



HSI: Colorful Light Modes

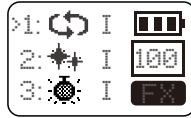

FX: Situational Special Effects Modes

## Included Items

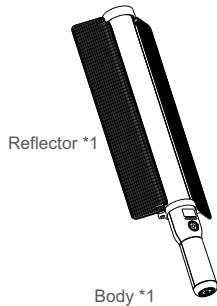

## Battery Management

### 1. Power Supply

With built-in Li-polymer battery which can offer about 1.5 hours'lighting in 100% brightness once got fully charged.

### 2. Charge

The whole charging takes about 2.5 hours. The charge indicator turns to red in charging while green once got fully charged.

## Attaching Reflector

**Installation:** Choose the side which needs reflector and adjust the reflector's direction. Match the ridge in the reflector's handle ring with the groove on the handle(as shown) and slip the reflector over the LED ice light and push in. Extend the reflector for shooting.



**Detachment:** Hold the handle and push the reflector from the bottom up to detach.





# Operation

## 1. Setting

### 1.1 Power On/Off

Long press the  to power on/off the LED light and the current information will be displayed on the LCD panel.

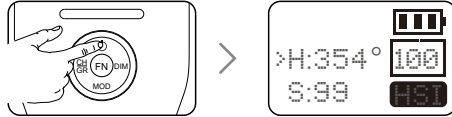

**1.2 Mode Selection:** Bicolor Mode/Colorful Mode/Situational Special Effects Mode. Press MOD button to switch different modes: CCT displayed on the screen means bicolor mode, HIS displayed on the screen means colorful mode and FX means situational special effects mode.

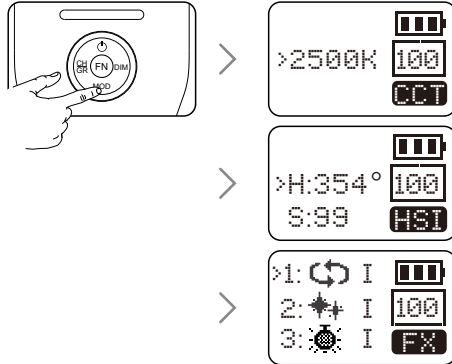

## 2. Wireless Remote Control

With 2.4G wireless system, this product has remote grouping and control function. Up to 6 groups of LED light stick can be controlled. 16 channels are available with strong anti-interference capability.

Please set the channels and groups of LED ice light to the same as those of remote control before usage.

Channel/Group/ID Setting: Press CH/GR to enter the setting interface.

**Note:** Remote control purchased separately

**2.1 Channel setting:** press the FN button to choose CH and turn the select dial to choose channel value from 1 to 32.

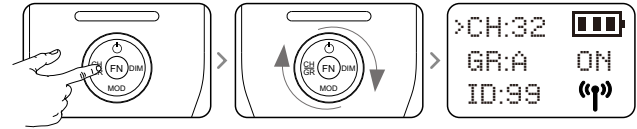

**2.2 Group setting:** press the FN button to choose GR and turn the select dial to choose group value from A to F.

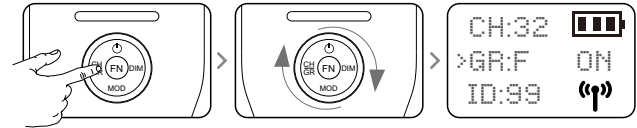

**2.3 ID setting:** press the FN button to choose ID and turn the select dial to choose ID from 1 to 99.

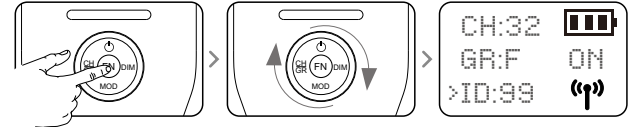

**2.4 Turn on/off the wireless:** press the FN button to choose  and turn the select dial to turn on or off the wireless.

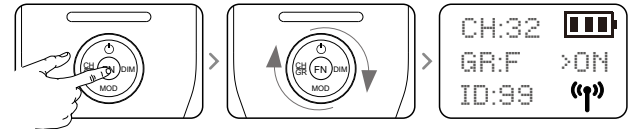

### 3. Bicolor Mode

**3.1 Color temperature adjustment:** turn the FN multifunction select dial to adjust the color temperature from 2500K to 8500K.

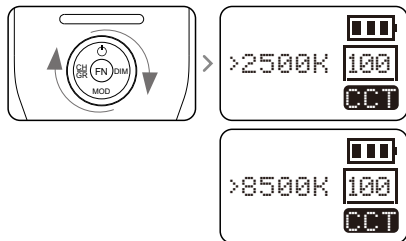

**3.2 Light brightness adjustment:** press the DIM button and the brightness value will be blinking. Turn the select dial to adjust the value from 0 to 100%.

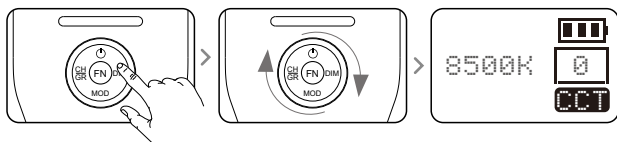

**3.3 P mode:** press the FN button and P will be displayed on the LCD panel, which means P mode. In P mode, the brightness will be change with the color temperature and reach the maximum value when color temperature is 4500K. In general mode, the brightness will keep the same when adjusting the color temperature.

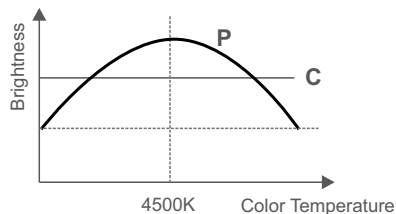

### 4. Colorful Mode

Press MOD button to enter setting interface.

**4.1 Adjust hue H:** press the FN multifunction select dial and H is selected. Turn the FN multifunction select dial to adjust the hue from 0 to 360°.

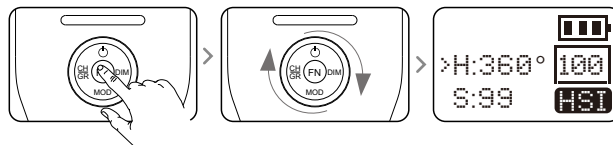

**4.2 Adjust saturation S:** press the FN multifunction select dial and S is selected. Turn the FN multifunction select dial leftwards or rightwards to adjust the saturation from 0 to 100.

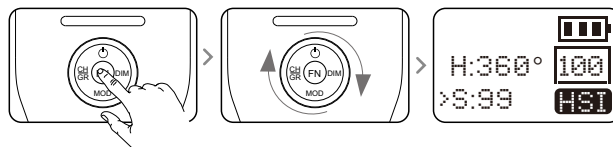

**4.3 Adjust light brightness:** press the DIM button and turn the select dial to adjust the brightness from 0-100%.

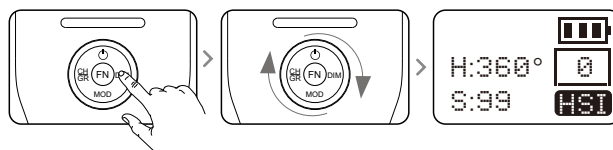

## 5. FX Situational Special Effects Mode(39 kinds)

5.1 Turn the select dial to choose different special effects modes from 1 to 14. And the modes will display circularly by turning the select dial.

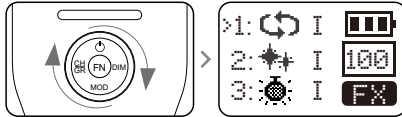

5.2 After choosing the current mode, press down the FN multifunctional select dial from I, II and III. And the modes will display circularly when keeping pressing the FN multifunctional select dial.



5.3 Adjust light brightness: turn the light brightness select dial to adjust from 0 to 100%.

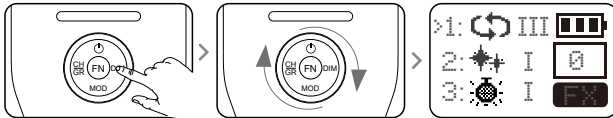

5.4 There're 39 kinds of situational special effects mode which are divided into 14 categories for your choice.

No.	Display	Situation	Display I	Display II	Display III
1	[Recycle icon]	Colorful lights recycle	Slow speed	Medium speed	Quick speed
2	[Flash icon]	Flash	Flash	Press conference	Paparazzi
3	[Laser icon]	Laser colorful lights	Birthday party	KTV	Disco
4	[Lightning icon]	Lightning	Discontinuous	Frequent	Sustainable
5	[Broken bulb icon]	Broken bulb	Discontinuous	Frequent	Sustainable
6	[TV icon]	TV	Slow speed	Medium speed	Quick speed
7	[Candle icon]	Candle	Discontinuous	Frequent	Sustainable
8	[Fire icon]	Fire	Firewood	Campfire	Fire hazard
9	[Firework icon]	Firework	Brief	Continuous	Show
10	[Police car icon]	Police car	Strong flash	Frequent flash	Quick flash
11	[Fire truck icon]	Fire truck	Strong flash	Frequent flash	Quick flash
12	[Ambulance icon]	Ambulance	Strong flash	Frequent flash	Quick flash
13	[Music icon]	Music	Music I	Music II	
14	[SOS icon]	SOS			

## Technical Data

Model	LC500R
Built-in Lithium Battery	14.4V/2600mAh lithium battery
Power	Max. 23W
Channel	32
Group	6 ( A B C D E F )
Color Temperature Range	2500K ~ 8500K
Light Brightness Range	0%~100%
RGB Color Gamut	0 ~ 360°
100% Light Brightness(LUX)	Max. 5800
CR I(≈)	96
TLCI(≈)	98
Duration(continuous output in 100% full power)(≈)	Approx. 90 minutes
Operation Temperature	-10~40 °C
Dimension (without reflector)	616*56*56mm
Net Weight (without reflector)	0.81Kg

\* Product design and specifications are subject to change without notice.

## FCC Statement

This device complies with part 15 of the FCC Rules. Operation is subject to the following two conditions: (1) This device may not cause harmful interference, and (2) this device must accept any interference received, including interference that may cause undesired operation.

**Note:** This equipment has been tested and found to comply with the limits for a Class B digital device, pursuant to part 15 of the FCC Rules. These limits are designed to provide reasonable protection against harmful interference in a residential installation. This equipment generates uses and can radiate radio frequency energy and, if not installed and used in accordance with the instructions, may cause harmful interference to radio communications. However, there is no guarantee that interference will not occur in a particular installation. If this equipment does cause harmful interference to radio or television reception, which can be determined by turning the equipment off and on, the user is encouraged to try to correct the interference by one or more of the following measures:

- Reorient or relocate the receiving antenna.
- Increase the separation between the equipment and receiver.
- Connect the equipment into an outlet on a circuit different from that to which the receiver is connected.
- Consult the dealer or an experienced radio/TV technician for help.

## 产品保修

尊敬的用户，本保修卡是申请维修服务的重要凭证，请您配合销售商填写并妥善保管，谢谢！

产品信息	型号	产品条码
用户信息	姓名	联系电话
	通信地址	
销售商信息	名称	
	联系电话	
	通信地址	
	销售日期	
备注		

注：此表应由销售商盖章确认。

### 如何获得保修服务

要维修服务，您可直接与产品销售商或授权服务机构联系，也可拨打神牛产品售后服务电话，与我们联系，由我们的服务人员为您安排服务。申请保修时，您应提供有效的保修卡作为保修凭证，方可获得保修。如您不能提供有效的保修卡，则在我们可确认产品或部件属于保修范围的情况下，也可以为您提供保修，但这不作为我们的义务。

### 不适用保修的情况

如产品存在下列情况，本文件项下的保证和服务将不适用 ①产品或部件超过相应保修期；②错误或不适当使用、维护或保管导致的故障或损坏，如：不当搬运；非按产品合理预期用途使用；不当插拔外接设备；跌落或外力挤压；接触或暴露于不当温度、溶剂、酸碱、水浸或潮湿环境；③由非神牛授权机构或人员安装、修理、更改、添加或拆卸造成的故障或损坏；④产品或部件原有识别信息被修改变更或删除；⑤无有效保修卡；⑥使用非合法授权、非标准或非公开发行的软件造成的故障或损坏；⑦因不可抗力或意外事件造成的故障或损坏；⑧其他非因产品本身质量问题导致的故障或损坏。遇上述情况，您应向相关责任方寻求解决，神牛对此不承担任何责任。因非在保修期或保修范围内的部件、附件或软件导致产品不能正常使用的，不是保修范围内的故障。产品使用过程中正常的脱色，磨损和消耗，不是保修范围内的故障。

### 产品保修和服务支持信息

产品的保修期和服务类型按以下《产品保修信息》执行：

产品类别	选项名称	保修期(月)	保修服务类型
部件	电路板	12	客户送修
	电池	3	客户送修
	充电器、电源线、同步线等带电性能的部件。	12	客户送修
其他	如闪光灯、造型灯泡、外壳、保护罩、锁紧装置、包装等。	无	无保修

### 适用产品

本文件适用于相关《产品保修信息》(见后面说明)所列产品，其他非属此范围的产品或部件(如促销品、赠品及其他出厂后附加的部件等)不在此保修承诺内。

### 保修期

产品及部件的相应保修期按相关的《产品保修信息》执行。保修期自产品首次购买日起算，购买日以购买产品时保修卡登记日期为准。

神牛产品售后服务电话 0755-29609320-8062

# Warranty

Dear customers, as this warranty card is an important certificate to apply for our maintenance service, please fill in the following form in coordination with the seller and safekeep it. Thank you!

Product Information	Model	Product Code Number
Customer Information	Name	Contact Number
	Address	
Seller Information	Name	
	Contact Number	
	Address	
	Date of Sale	
Note:		

Note: This form shall be sealed by the seller.

## Warranty Period

The warranty period of products and accessories is implemented according to the relevant Product Maintenance Information. The warranty period is calculated from the day (purchase date) when the product is bought for the first time. And the purchase date is considered as the date registered on the warranty card when buying the product.

## How to Get the Maintenance Service

If maintenance service is needed, you can directly contact the product distributor or authorized service institutions. You can also contact the Godox after-sale service call and we will offer you service. When applying for maintenance service, you should provide valid warranty card. If you cannot provide valid warranty card, we may offer you maintenance service once confirmed that the product or accessory is involved in the maintenance scope, but that shall not be considered as our obligation.

## Inapplicable Cases

The guarantee and service offered by this document are not applicable in the following cases: ①. The product or accessory has expired its warranty period; ②. Breakage or damage caused by inappropriate usage, maintenance or preservation, such as improper packing, improper usage, improper plugging in/out external equipment, falling off or squeezing by external force, contacting or exposing to the improper temperature, solvent, acid, base, flooding and damp environments, etc; ③. Breakage or damage caused by non-authorized institution or staff in the process of installation, maintenance, alternation, addition and detachment; ④. The original identifying information of product or accessory is modified, alternated, or removed; ⑤. No valid warranty card; ⑥. Breakage or damage caused by using illegally authorized, nonstandard or non-public released software; ⑦. Breakage or damage caused by force majeure or accident; ⑧. Breakage or damage that could not be attributed to the product itself. Once met these situations above, you should seek solutions from the related responsible parties and Godox assumes no responsibility. The damage caused by parts, accessories and software that beyond the warranty period or scope is not included in our maintenance scope. The normal discoloration, abrasion and consumption are not the breakage within the maintenance scope.

## Maintenance and Service Support Information

The warranty period and service types of products are implemented according to the following Product Maintenance Information:

Product Type	Name	Maintenance Period(month)	Warranty Service Type
Parts	Circuit Board	12	Customer sends the product to designated site
	Battery	3	Customer sends the product to designated site
	Electrical parts e.g.battery charger, power cord, sync cable, etc.	12	Customer sends the product to designated site
Other Items	Flash tube, modeling lamp, lamp body, lamp cover, locking device, package, etc.	No	Without warranty

Godox After-sale Service Call **0755-29609320-8062**

## Applicable Products

The document applies to the products listed on the Product Maintenance Information (see below for further information). Other products or accessories (e.g. promotional items, giveaways and additional accessories attached, etc.) are not included in this warranty scope.