

## **PORTABLE FRIDGE & WARMER**

---

## **USER'S MANUAL**

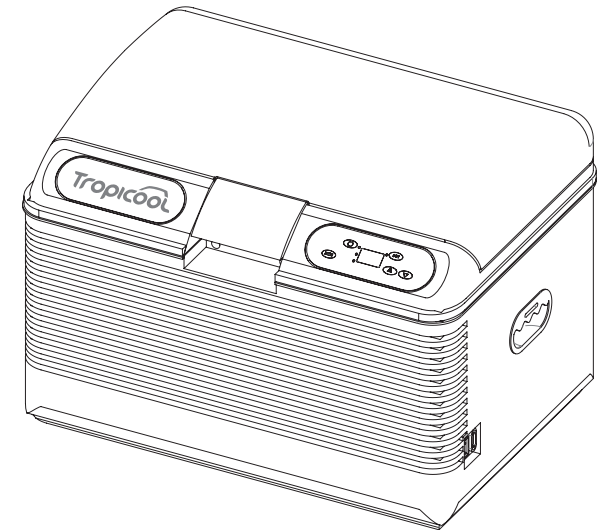

**Tropicool®**

**Tropicool Car Gadgets Pvt. Ltd.**

[www.tropicoolindia.com](http://www.tropicoolindia.com)

Customer Care No. +91-92261 92262

### INDEX

Operational Safety-----1~3

Unit Features----- 4







Operating Instructions---5~8

Troubleshooting-----9

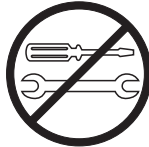
Warranty

---

Item	Reason	Troubleshooting
Basic Inspection	Power failure.	Make sure power cord is completely plugged in.
	Power failure when car is running.	Check for burnt cigarette lighter fuse.
Cooling problems	Unit cover is not completely closed.	Make sure unit cover is tightly sealed.
	Unit does not have sufficient cooling period.	Minimize the time the cover is lifted.
	Fan is not turning.	Please contact your local agent.
	The environment temperature is too high.	Move unit to cool surroundings.
	Other cooling problems.	Please contact your local agent.
Heating problems	Unit cover is not completely closed.	Make sure unit cover is tightly sealed.
	The environment temperature is too low.	Move unit to warm surroundings.
	Others heating problems.	Please contact your local agent.
Power problems	AC cable is not properly connected	Make sure that AC power cord is completely plugged in.
	DC cable is not properly connected	Make sure that DC power cord is completely plugged in.
	Other power problems	Please contact your local agent.

⊘ Warning	
	Do not remove or disassemble: Consult a qualified service engineer; do not disassemble, fix or modify. >May cause fire and/or electrical shock. >Service the unit according to this guide only.
	Do not place unit in a wet or humid area. >May cause electrical shock and/or power shortage.
	Do not place metal objects, such as paper clips, near the intake or output vents. >May cause electrical shock and/or power shortage.
	Do not place weight on, modify, or entangle the power cord. >May cause electrical shock and/or fire.
	Do not handle power supply with wet or sweaty hands. >May cause electrical shock.
	Use only the supplied wires and plug. >May cause electrical shock and/or fire.

## How to operate the Control Panel:

### 1. Start

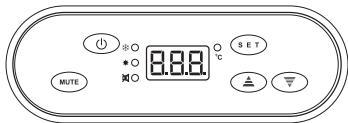

Press POWER switch to turn it on.  
(Again to turn it off)

### 2. Display

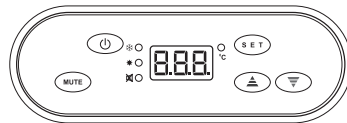

The temperature screen to show your setting.

### 3. Setting

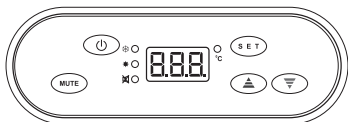

Press button to adjust your needed Temp.  
Press set to lock the temperature.  
▽ : Decrease Temperature  
▲ : Increase Temperature

### 4. Indicate

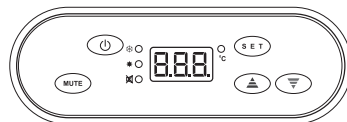

Lamp show up or down Temp. or Mute  
1st Lamp shows down Temp.  
2nd Lamp shows up Temp.  
3rd Lamp shows Mute

### 5. Mute

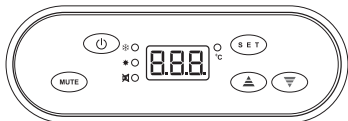

Press MUTE switch to turn on quiet function.  
And press again to turn normal.  
( On mute mode, it takes longer time than normal mode for increasing & decreasing Temp. )

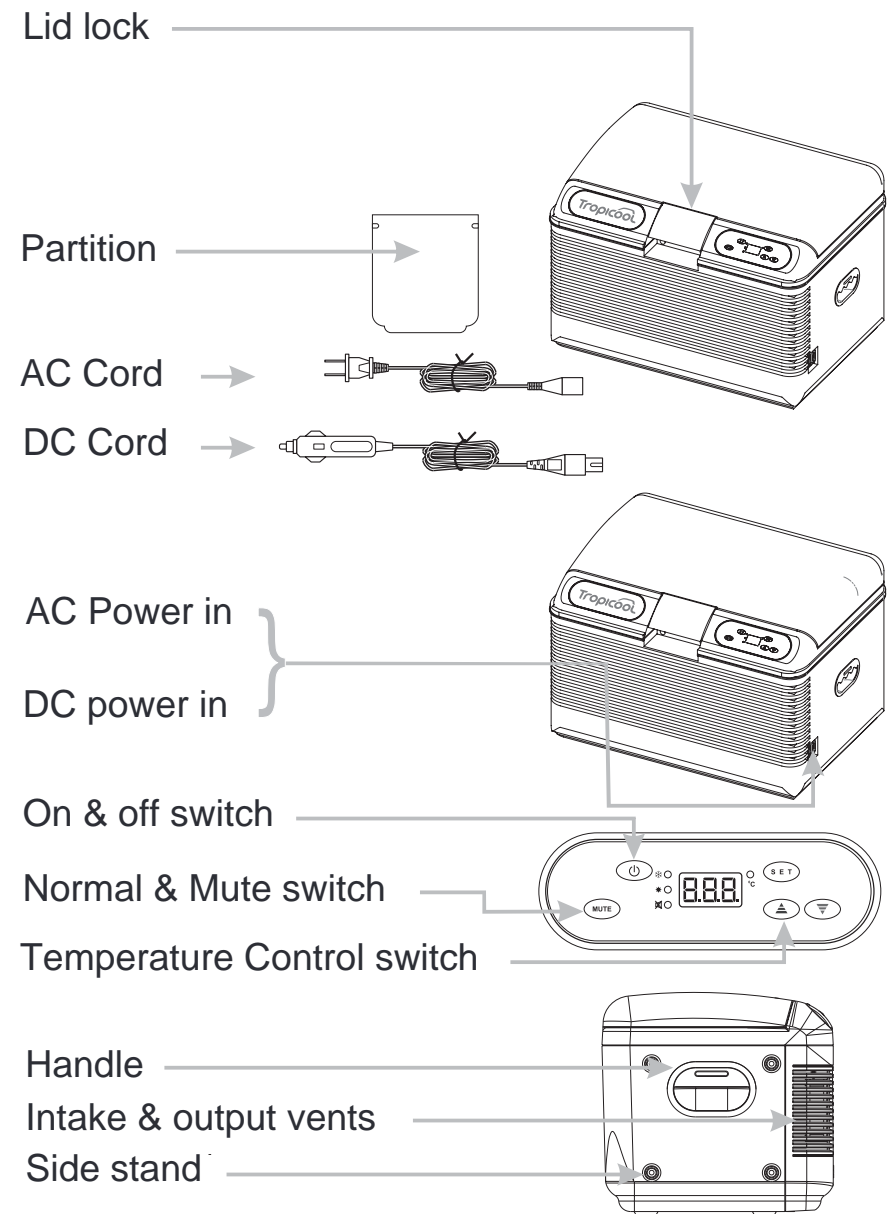

## Important Operational Safety Guide

1. Before using your unit, please follow the safety guides provided in this manual.
2. To ensure safe usage and trouble-free performance, please pay special attention to the notice below.
3. Please save this manual for future reference.

## Please Follow the Below Guidelines

**Warning:** May lead to serious injuries or death.



Specific action prohibited.

Left diagram: Do not remove or disassemble.

**Caution:** May lead to injuries or unit damage.



Administer with great caution.

Left diagram: Handle with care.

**Instructions:** Please administer in accordance with the guideline.



Please follow the instruction indicated.









Plug in as indicated.

## WARRANTY

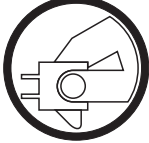

Model name	Tropicool- 12AD 3.0 Sr.No.		
Warranty period	Sales agent :		
2 years from the buying date			
The buying date			
YY / MM / DD			
Customer Name		Tel	
Address			

### Warranty Conditions :

1. This unit is covered by a limited two years warranty.  
**Important:** Please read and follow the usage and care guide on proper product installation and operation procedures carefully. This limited warranty covers only damages resulting from normal operations and is valid two years from the date of purchase.
2. All repairs/ replacements outside the warranty period or resulting from the following may require additional service fees:
  - \*Damages caused by improper use, including but not limited to incorrect voltage application and all unauthorized alterations/repair.
  - \*Damages resulting from natural disasters, electrical shock, water hazard, or any other uncontrollable factors.
  - \*Damages occurred during shipping and handling.
  - \*Warranty certificates without official company stamp or with incomplete, illegible, or altered dates.
  - \*Replacement of accessories.
3. For all warranty and non-warranty servicing, customers are responsible for the delivery to and pick up from the company's authorized repair center.  
 Tropicool Car Gadgets Pvt. Ltd. is not responsible for any damages occurred during shipping and handling.
4. The completed warranty certificate is required to be received by us for warranty repair service. Lost certificates will not be replaced.

 <b>Warning</b>	
	Do not touch when unit is in "HOT" mode. >May cause burns.
	Keep socket clear of obstructions. May cause electrical shock and/or poor connection.
 <b>Caution</b>	
	Handle with care when opening and closing the lid. >May jam and/or cause hand injuries.
 <b>Directions</b>	
	Grip the power plug firmly when disconnecting. >May cause wire damage, electrical shock, and/or fire if pulled by the wire.
	Unplug when not in use for long periods. >May cause rusting, electrical shock, and/or fire.

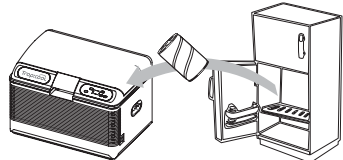
## Suggested Use

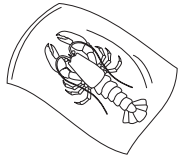
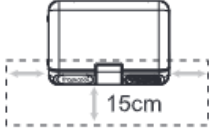
		
In order to save energy, cool beverages in regular refrigerator first.	Dry the surface of contents to prevent water from crystallizing in the unit.	Keep fresh product in tightly sealed bags to prevent water from crystallizing in the unit.
		
During operation, Place unit in a ventilated space to ensure optimal performance.		

## Uses not recommended:

		
Do not store fresh product in unit for a long period of time.	Do not store open beverage containers.	Do not store carbonated drinks when set in warm mode.

# Operating Instructions

## Normal standing

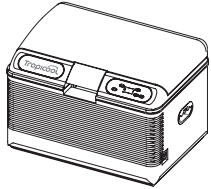

## Side standing

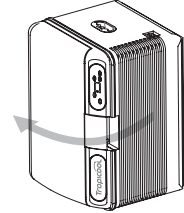

## How to open the unit cover

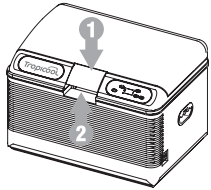

## Installing belt

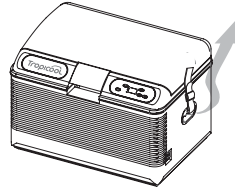

## DC Power

12 / 24 V

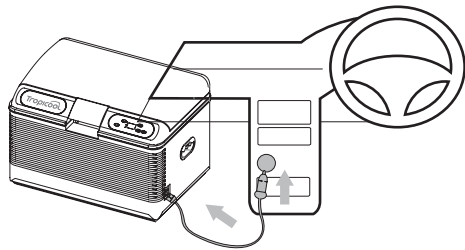

## AC Power

AC 220V

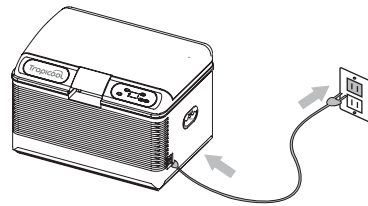

## 12L size

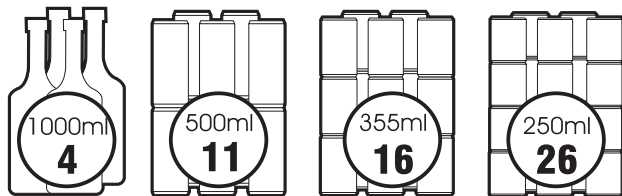

# Operating Instructions

## Panel operation manual

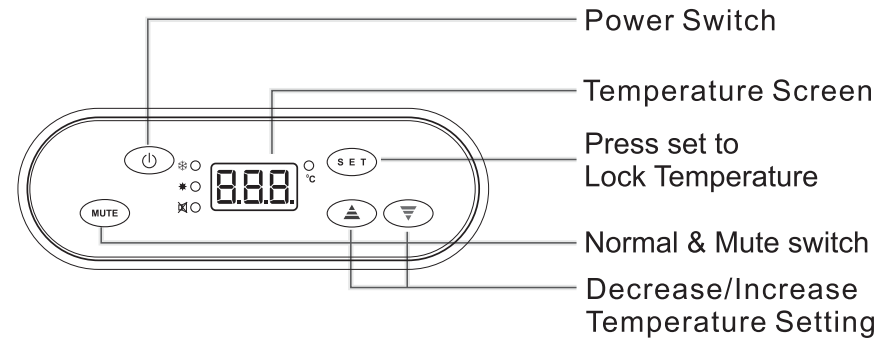

## Temperature guide

