

PHILIPS

Soundbar

8000 Series

TAB8947



www.philips.com/welcome





- EN** Download Google Home app
- ES** Descargue la app Google Home
- FR** Télécharger l'appli Google Home
- PT** Baixe o aplicativo Google Home
- DE** Google Home App herunterladen

Google Home **AR** نزل تطبيق

- ID** Unduh aplikasi Google Home
- TH** ดาวน์โหลดแอป Google Home
- TW** 下載 Google Home 應用程式
- JA** Google Homeアプリをダウンロードします
- KO** Google Home 앱 다운로드
- VT** Tải xuống ứng dụng Google Home

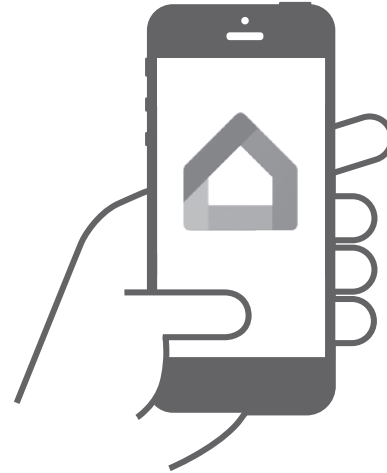



- EN** Before using your Product, read all accompanying safety information
- ES** Antes de usar el producto, lea toda la información de seguridad que lo acompaña
- FR** Avant d'utiliser votre produit, lisez toutes les informations de sécurité qui l'accompagne.
- PT** Antes de utilizar o produto, leia todas as informações de segurança que o acompanham
- DE** Bevor Sie Ihr Produkt verwenden, lesen Sie alle begleitenden Sicherheitsinformationen

AR قبل استخدام المنتج الخاص بك ، اقرأ جميع معلومات السلامة المصاحبة

- ID** Sebelum menggunakan produk, baca semua informasi petunjuk keamanan
- TH** ก่อนใช้งานผลิตภัณฑ์ โปรดอ่านข้อมูลด้านความปลอดภัยทั้งหมดที่แนบมาด้วย
- TW** 使用產品前，請閱讀隨附的所有安全資訊
- JA** 本製品を使用する前に、安全上のご注意事項をすべてお読みください
- KO** 제품을 사용하기 전에 동봉된 모든 안전 정보를 읽어보십시오
- VT** Trước khi sử dụng Sản phẩm của bạn, hãy đọc tất cả thông tin an toàn kèm theo

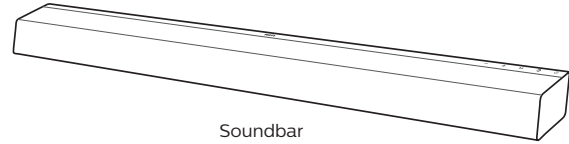

Soundbar



Remote Control and batteries

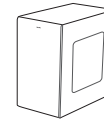

Wireless Subwoofer



Soundbar Wall Bracket



Soundbar Wall Bracket Screws (for walls) 2 X 2 X



TAB8947/98



TAB8947/96

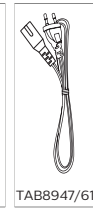

TAB8947/61

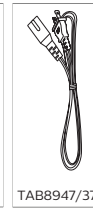

TAB8947/37

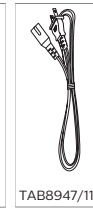

TAB8947/11



TAB8947/94

*2X Power Cord (Soundbar, and Subwoofer)



Warranty Card Safety Sheet

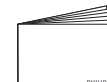

Quick start guide



User Manual (only for /96 Taiwan, /61 South Korea, for /11 Japan)



Wall Mount Template

* Power cord quantity and plug type vary by regions

* 付属の電源ケーブルは本製品専用になります。他の製品にはご使用できません。

1

- EN** Position the SoundBar / Wall mount the SoundBar (optional)
- ES** Colocar la barra de sonido/Montar la barra de sonido en la pared (opcional)
- FR** Placement / Montage mural (en option) de la barre de son
- PT** Ustaw soundbar / zamontuj soundbar na ścianie (opcjonalnie)
- DE** Positionierung der SoundBar / Wandmontage der SoundBar (optional)

AR قم بتثبيت العارضة الصوتية/قم بتعليق العارضة ال صوتية على الجدار (اختياري)

- ID** Posisikan SoundBar/Pasang SoundBar di tembok (opsional)
- TH** การจัดตำแหน่งซาวด์บาร์/ติดตั้งซาวด์บาร์บนกำแพง (ไม่จำเป็น)
- TW** 放置聲霸/壁掛式安裝聲霸 (可選)
- JA** サウンドバーをオーディオラックの上などに設置します。(日本では壁取り付けは推奨しておりません。棚置き設置でご使用ください。)
- KO** 사운드바 배치/사운드바 벽면 장착(음선)
- VT** Xác định vị trí SoundBar / Tường gắn SoundBar (tùy chọn)

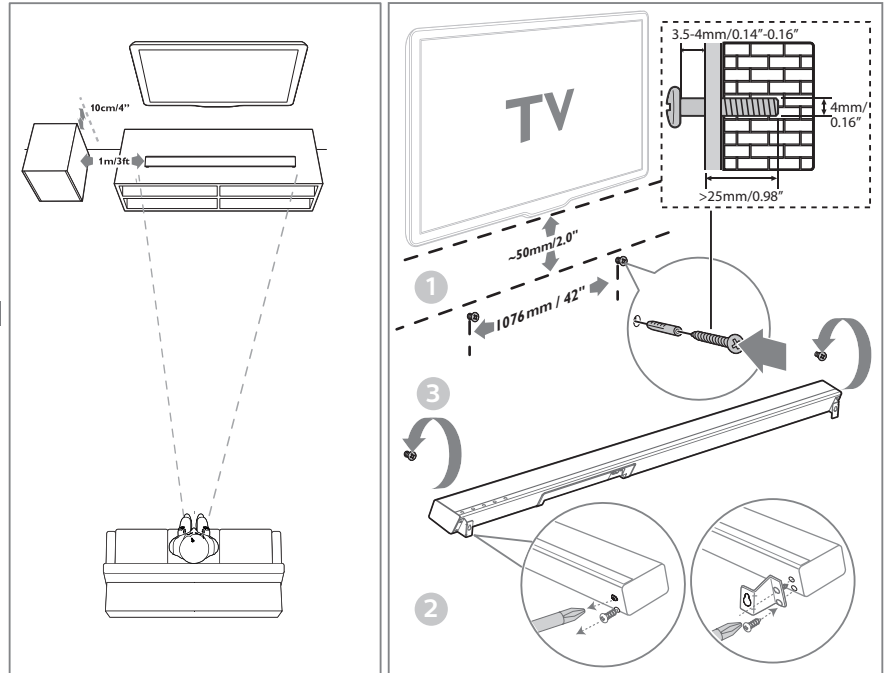

Suggested wall mounting height

You are suggested to install the TV first before wall mounting the soundbar.

With a TV preinstalled, wall mount the soundbar 50mm/2.0" in distance from the bottom of the TV.

If you wall mount the soundbar first, drill 2 parallel holes (Ø 3-8 mm each according to wall type) in the wall. The distance between the holes should be 1076mm / 42".

2

- EN** Hear audio from TV in one of the following ways
- ES** Escuche el audio del televisor de una de las formas siguientes
- FR** Écoutez le son du téléviseur par l'un de ces moyens
- PT** Ouça o áudio da televisão de uma das seguintes formas
- DE** Hören Sie den Fernsehton auf eine der folgenden Arten
وصول الصوت من التلفاز بإحدى الطرق التالية **AR**
- ID** Nikmati audio TV dengan salah satu cara berikut
- TH** ได้ยินเสียงจากทีวีในแบบใดแบบหนึ่งดังต่อไปนี้
- TW** 透過以下方式之一收聽電視的音訊
- JA** HDMI、光デジタル、アナログケーブルのいずれかの方法でテレビと接続してください
- KO** 다음 방법 중 하나로 TV 오디오 듣기
- VT** Nghe âm thanh từ TV theo một trong các cách sau đây

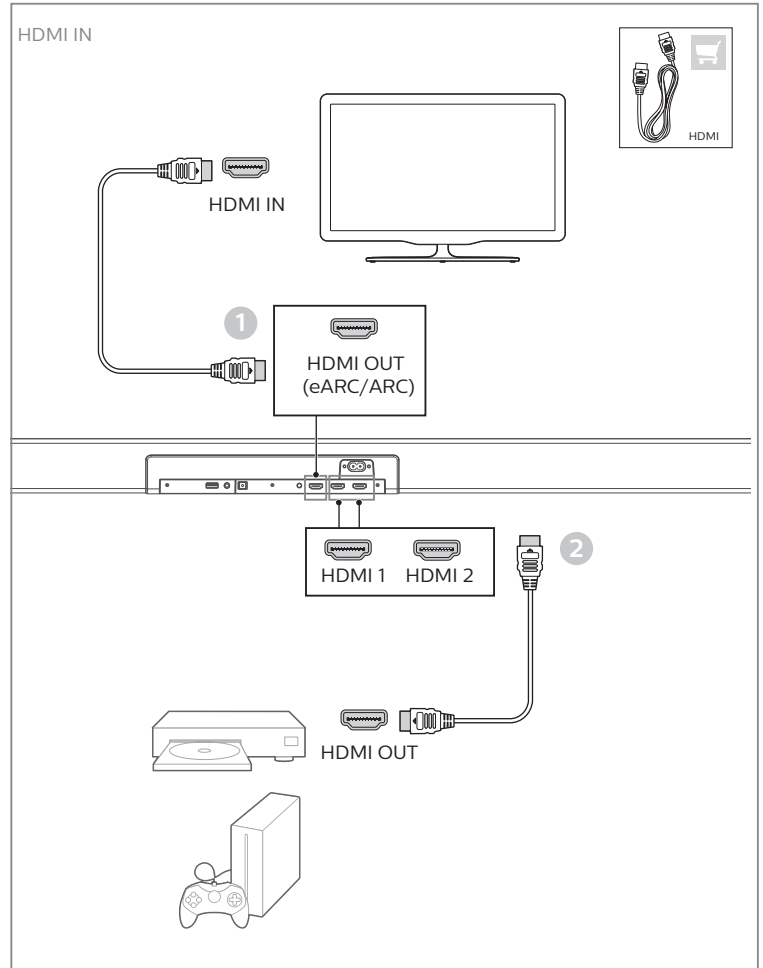

HDMI eARC/ARC

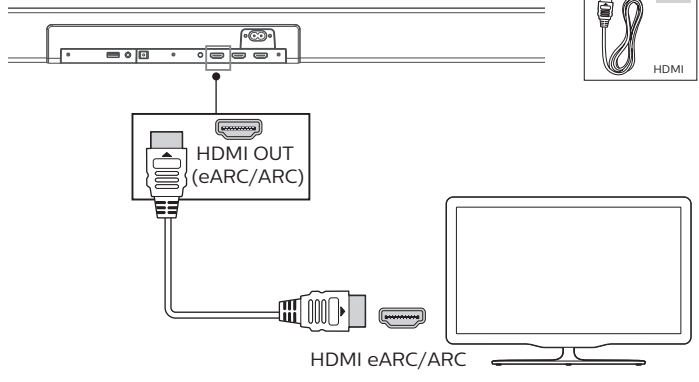

AUX

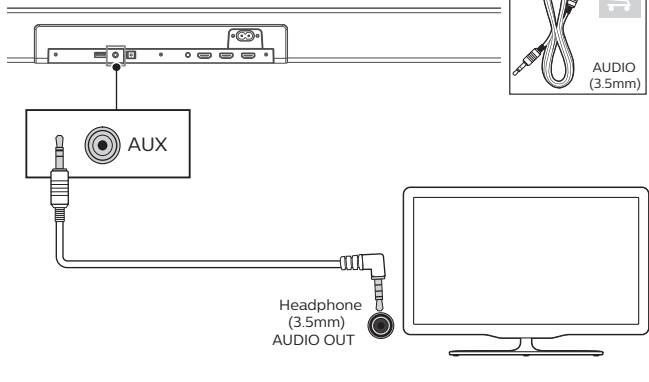

OPTICAL

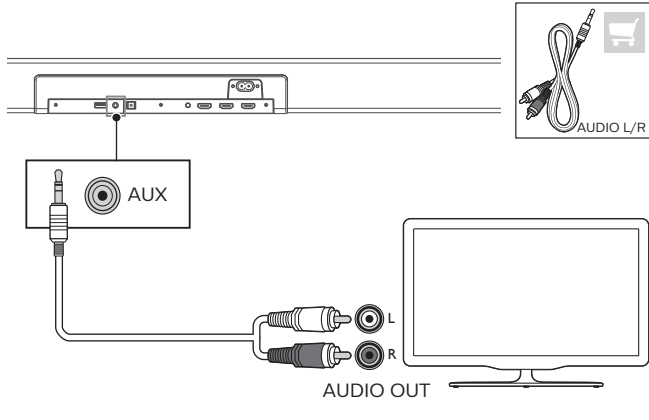
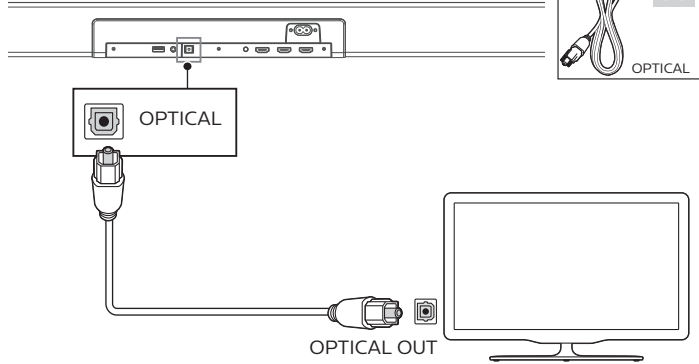

3

- EN** Connect to power. Switch on the SoundBar
- ES** Conecte el equipo a una fuente de alimentación. Encender la barra de sonido
- FR** Connecter à l'alimentation. Allumez la barre de son
- PT** Conecte à energia. Ligue a Soundbar
- DE** Mit Stromversorgung verbinden. Schalten Sie die SoundBar ein

التوصيل بالطاقة **AR**
قم بتشغيل العارضة الصوتية

ID Sambungkan ke Daya. Nyalakan SoundBar

TH เชื่อมต่อกับ ไฟฟ้า. เปิดซาวด์บาร์

TW 連線到電源, 開啟聲霸

JA 電源ケーブルを壁のコンセントに接続
します。リモコンに電池を入れます。電
源をオンにします

KO 전원 연결.사운드바 켜기

VT Kết nối với sức mạnh. Bật SoundBar

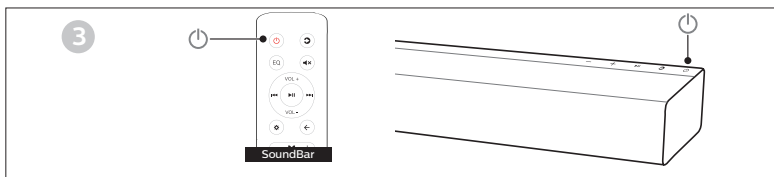
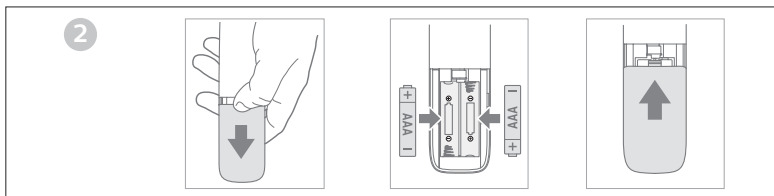
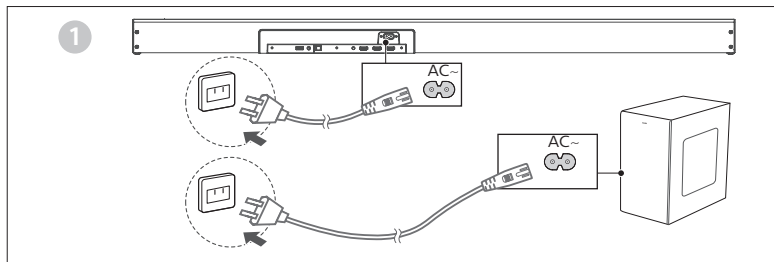

4

EN Connect the SoundBar

ES Conectar la barra de sonido

FR Connexion de la barre de son

PT Ligue a SoundBar

DE Anschließen der SoundBar

قم بتوصيل العارضة الصوتية **AR**

ID Hubungkan SoundBar

TH การเชื่อมต่อซาวด์บาร์

TW 連接聲霸

JA サウンドバーとウーファーを接続します

KO 사운드바 연결

VT Kết nối SoundBar

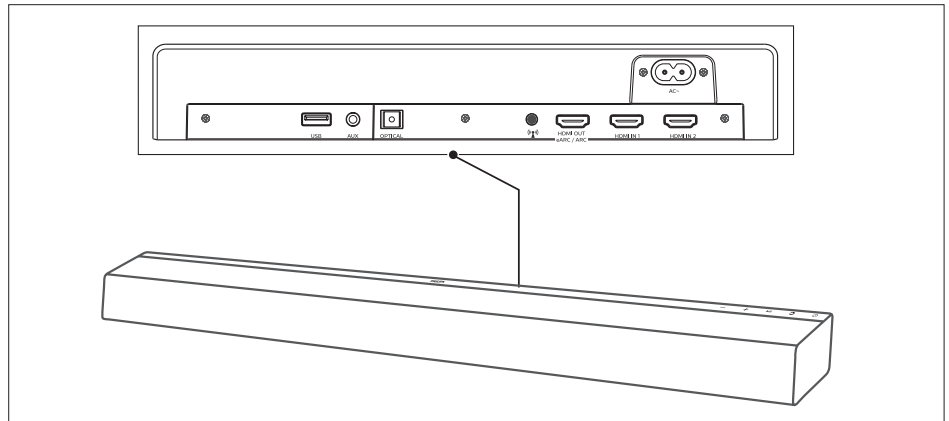
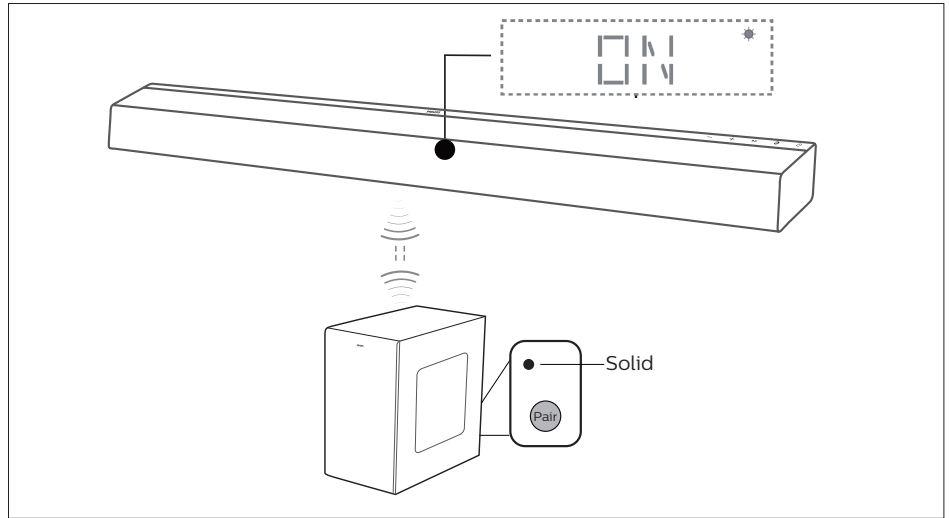



- EN** Manual subwoofer set up (no subwoofer connection/sound)
- ES** Configurar manualmente el subwoofer (cuando no se puede conectar o no se escucha el audio)
- FR** Configuration manuelle du caisson de basses (pas de caisson de basses/de son)
- PT** Configuração manual do subwoofer (sem conexão/som do subwoofer)
- DE** Manuelle Einrichtung des Subwoofers (keine Subwoofer-Verbindung/kein Ton)
- AR** الإعداد اليدوي لمضخم الصوت (لا يوجد اتصال/صوت بمضخم الصوت)
- ID** Pengaturan subwoofer manual (jika sambungan ke subwoofer gagal/suara tidak keluar)
- TH** การตั้งค่าซับวูฟเฟอร์แบบแมนนวล (ไม่มีการเชื่อมต่อซับวูฟเฟอร์ / เสียง)
- TW** 手動重低音喇叭設定 (無重低音喇叭連線/音效)
- JA** 万一接続しない場合は、手動で接続してください
- KO** 서브우퍼 수동 설정(서브우퍼 연결 안 됨/사운드 없음)
- VT** Cài đặt loa siêu trầm thủ công (không có kết nối / âm thanh loa siêu trầm)

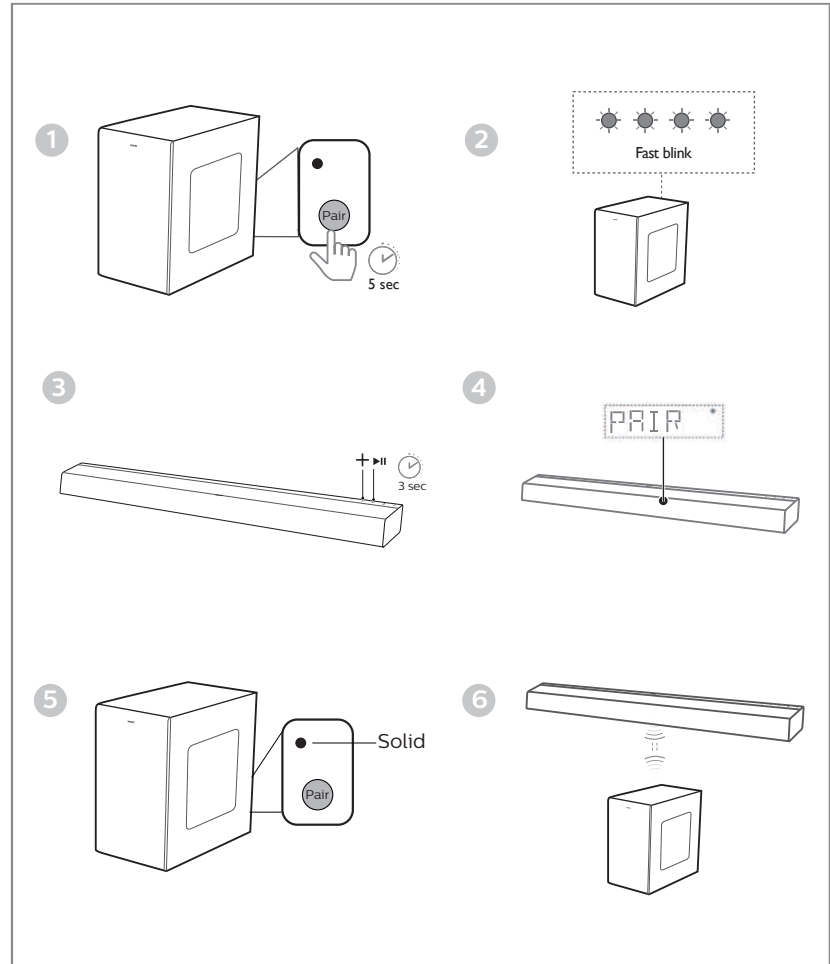

5

- EN** Wi-Fi set up
- ES** Configuración de Wi-Fi
- FR** Configuration Wi-Fi
- PT** Configuração do Wi-Fi
- DE** WLAN-Einrichtung
- AR** إعداد الواي فاي
- ID** Pengaturan Wi-Fi
- TH** การตั้งค่า Wi-Fi
- TW** Wi-Fi 設定
- JA** Wi-Fiの設定
- KO** Wi-Fi 설정
- VT** Thiết lập Wi-Fi

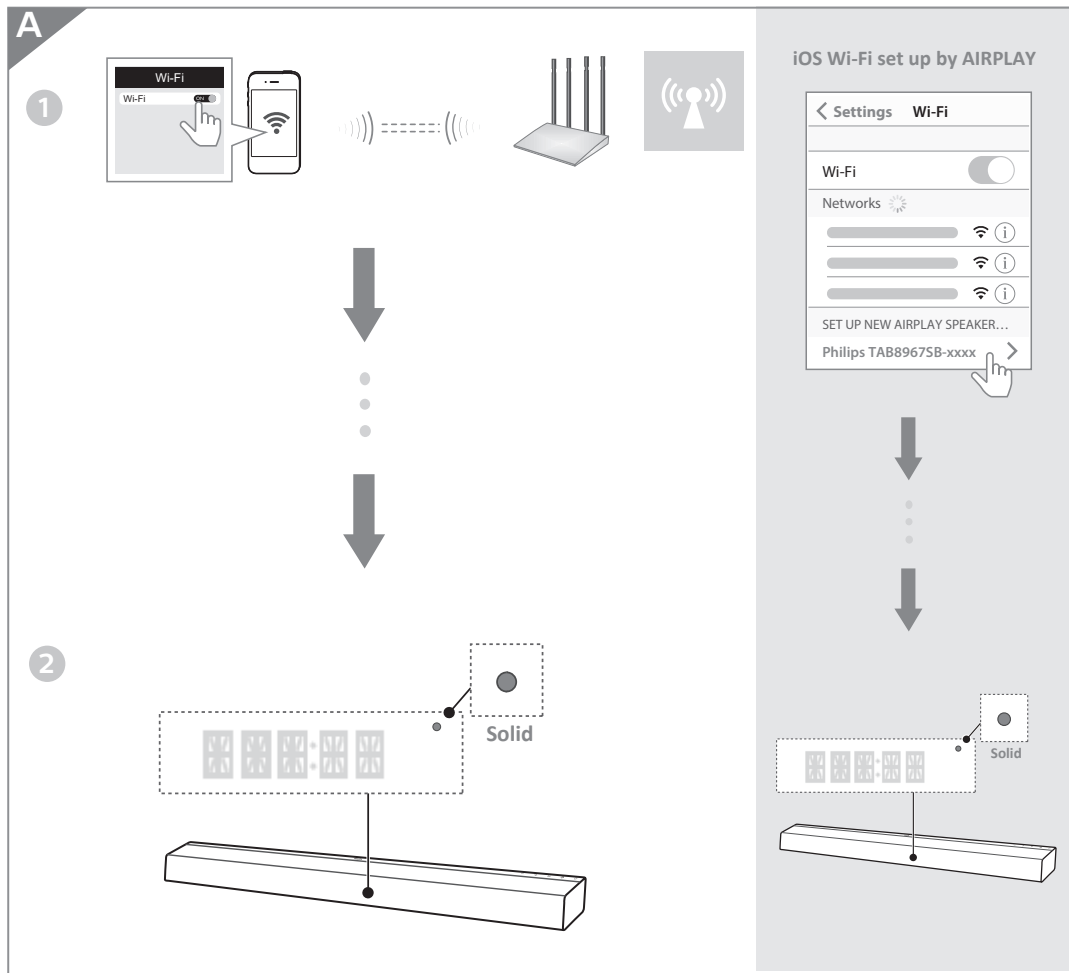

- EN** Wi-Fi protected setup (WPS)
- ES** Configuración protegida Wi-Fi (Wi-Fi protected setup, WPS)
- FR** Configuration Wi-Fi sécurisée (WPS)
- PT** Configuração protegida de Wi-Fi (WPS)
- DE** Einrichtung von geschütztem WLAN (WPS)
 - (WPS) إعداد واي فاي المحمي **AR**
- ID** Pengaturan Wi-Fi terproteksi (WPS)
- TH** การตั้งค่าการป้องกัน Wi-Fi (WPS)
- TW** Wi-Fi 受保護設定 (WPS)
- JA** Wi-Fiの設定 (WPS)
- KO** Wi-Fi 보호 설정(WPS)
- VT** Thiết lập được bảo vệ bằng Wi-Fi (WPS)

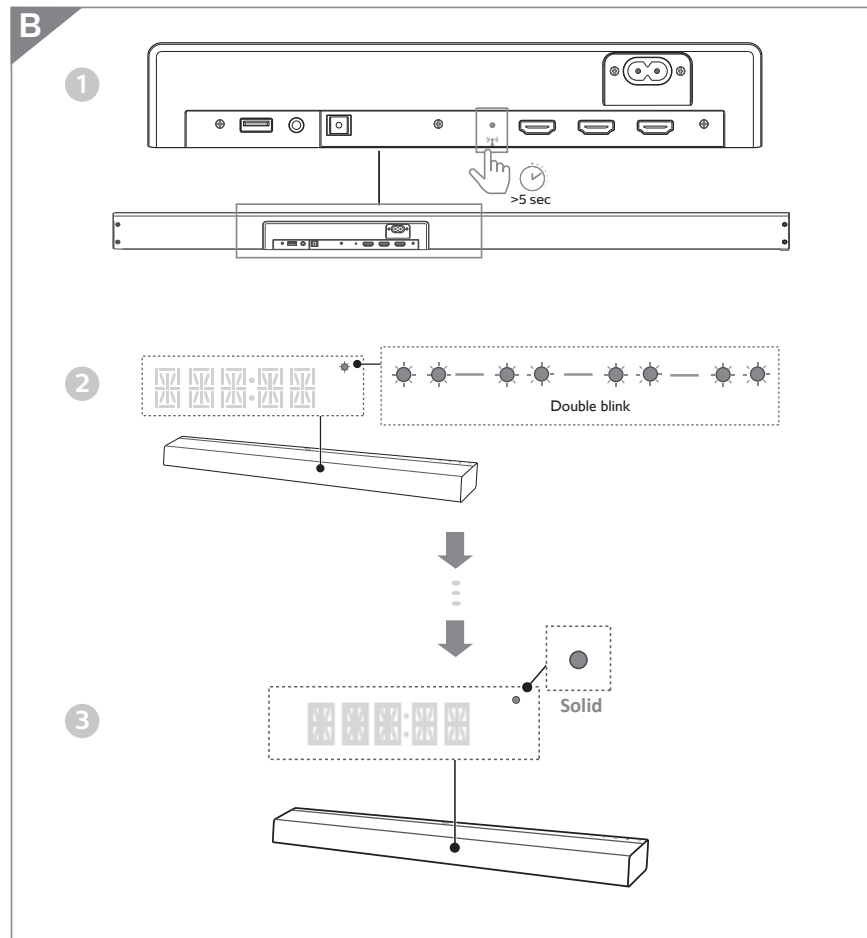

6

- EN** Select the correct audio source
- ES** Seleccionar la fuente de audio correcta
- FR** Sélectionnez la source audio appropriée
- PT** Selecione a fonte de áudio correta
- DE** Wählen Sie die richtige Audioquelle

حدد مصدر الصوت الصحيح **AR**

- ID** Pilih sumber audio yang benar
- TH** เลือกแหล่งที่มาของเสียงที่ถูกต้อง
- TW** 選擇正確的音訊來源
- JA** リモコンでオーディオソースを選択します
- KO** 올바른 오디오 소스 선택
- VT** Chọn nguồn âm thanh đúng

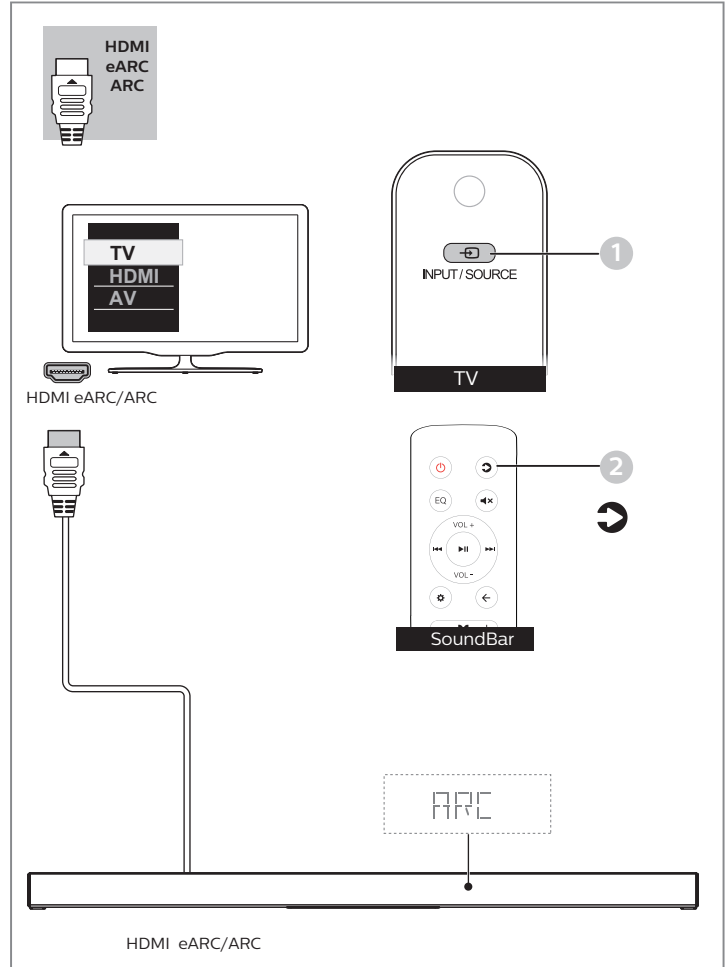

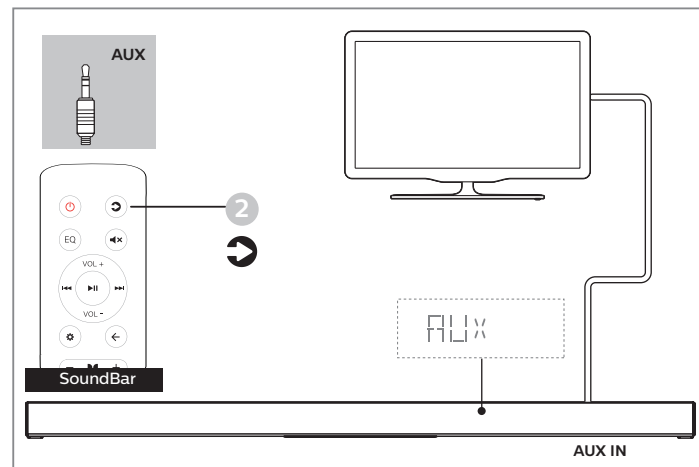
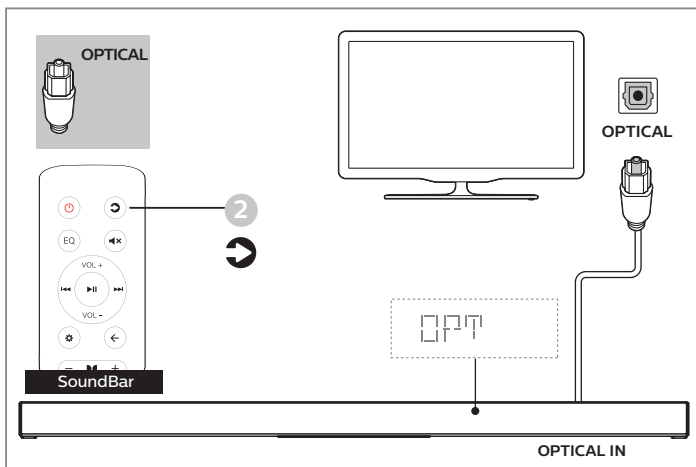
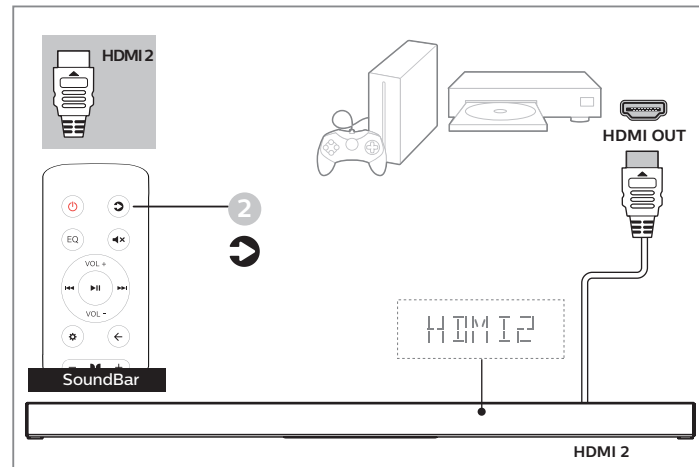
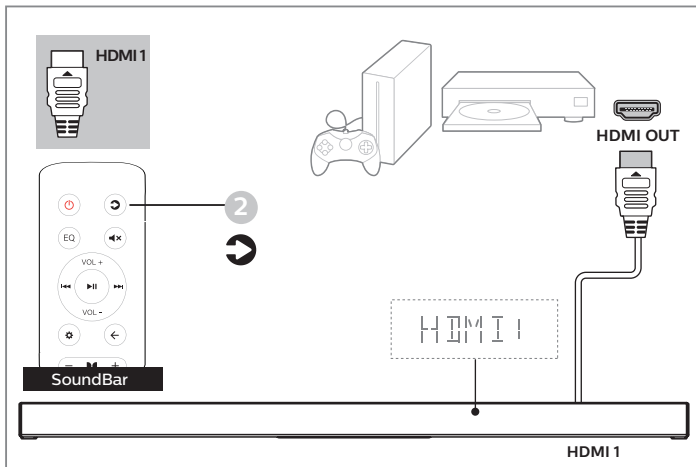

7

- EN** Play other devices
- ES** Reproducir otros dispositivos
- FR** Lecture d'autres appareils
- PT** Reproduzir outros dispositivos
- DE** Andere Geräte wiedergeben

ابدأ تشغيل الأجهزة الأخرى **AR**

- ID** Putar perangkat lainnya
- TH** เล่นจากอุปกรณ์อื่น
- TW** 播放其他裝置
- JA** テレビ以外の機器を接続し、再生することも可能です
- KO** 기타 장치 재생
- VT** Phát các thiết bị khác

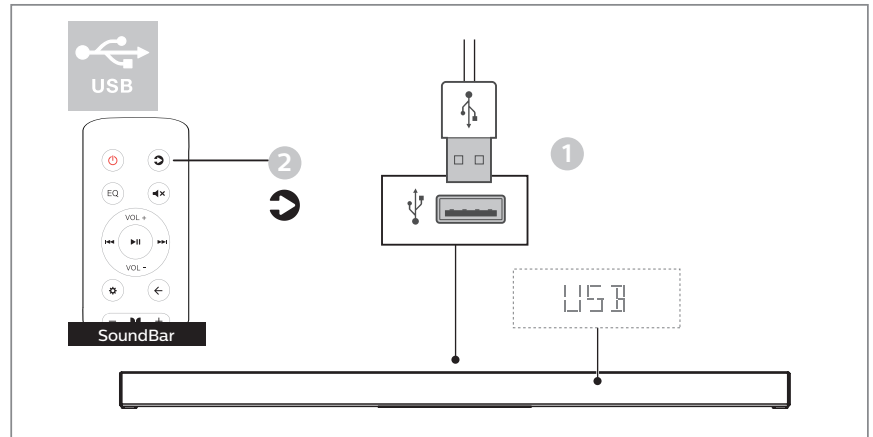
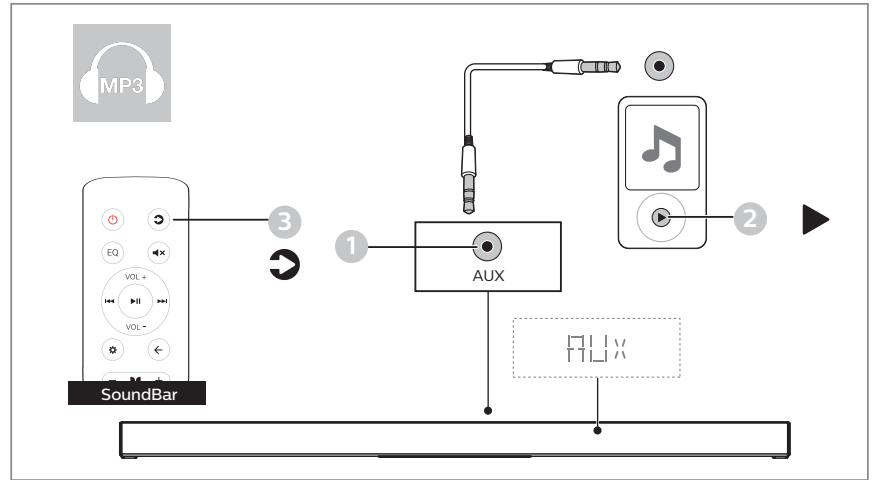

8

- EN** Play audio through Bluetooth
- ES** Reproducir audio mediante Bluetooth
- FR** Lecture de l'audio via Bluetooth
- PT** Reproduzir áudio via Bluetooth
- DE** Audiowiedergabe über Bluetooth

AR بدأ تشغيل الصوت عبر البلوتوث

ID Putar audio melalui Bluetooth

TH เล่นเสียงผ่านระบบ Bluetooth

TW 透過藍牙播放音訊

JA Bluetooth 機器の接続が可能です。リモコンの Bluetooth ボタンを押し、デバイス側の Bluetooth をオンにしてください。ペアリングが完了したら、音楽をお楽しみください

KO Bluetooth를 통해 오디오 재생

VT Phát âm thanh qua Bluetooth



Bluetooth
Frequency band / Output power
2400 MHz~2483.5 MHz / ≤ 5 dBm

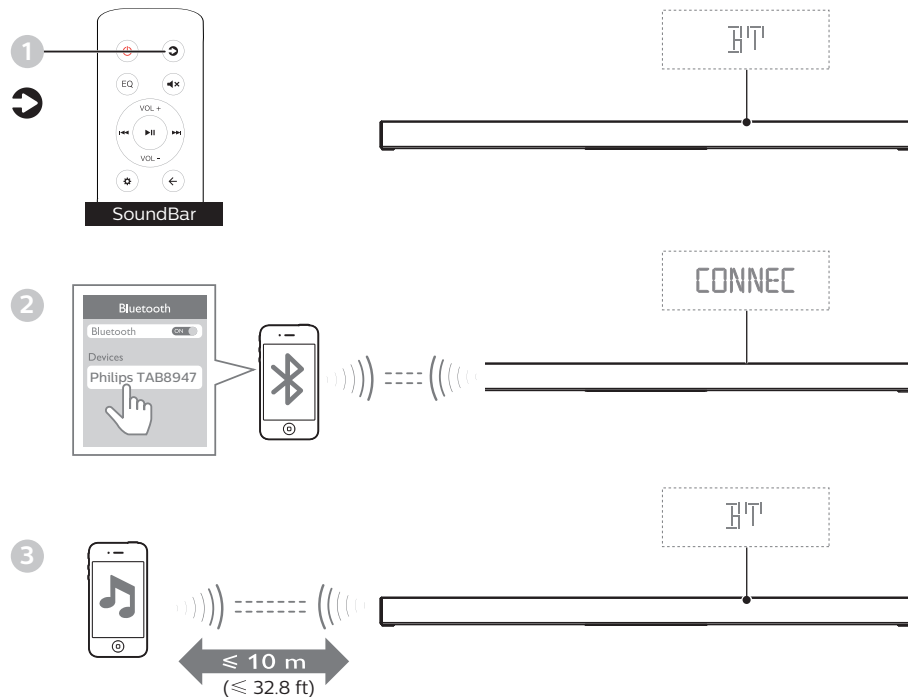



EN For more information about using this product, visit www.philips.com/support

ES Para obtener más información sobre el uso de este producto, visite www.philips.com/support

FR Pour plus d'informations sur l'utilisation de ce produit, visitez www.philips.com/support

PT Para obter mais informações sobre a utilização deste produto, visite www.philips.com/support.

DE Weitere Informationen zur Verwendung dieses Produkts finden Sie unter www.philips.com/support

AR لمزيد من المعلومات عن استخدام هذا المنتج، يرجى زيارة الرابط التالي www.philips.com/support

ID Untuk informasi lebih lanjut tentang produk ini, kunjungi www.philips.com/support

TH สำหรับข้อมูลเพิ่มเติมเกี่ยวกับการใช้งานผลิตภัณฑ์ โปรดไปที่ www.philips.com/support

TW 欲知有關使用本產品的更多資訊，請瀏覽 www.philips.com/support

JA 本製品の使用方法の詳細については、www.philips.com/support にアクセスしてください。

KO 제품 사용에 대한 자세한 내용은 사이트를 방문하십시오. www.philips.com/support

VT Để biết thêm thông tin về cách sử dụng sản phẩm này, hãy truy cập www.philips.com/support

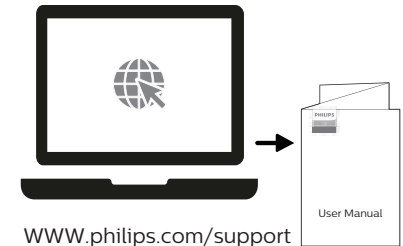



Specifications are subject to change without notice. Please visit www.philips.com/support for the latest updates and documents.

Philips and the Philips Shield Emblem are registered trademarks of Koninklijke Philips N.V. and are used under license. This product has been manufactured by and is sold under the responsibility of MMD Hong Kong Holding Limited or one of its affiliates, and MMD Hong Kong Holding Limited is the warrantor in relation to this product.

