

# ILIFE-T10s

Auto-Empty Robot Vacuum Cleaner

# User Manual

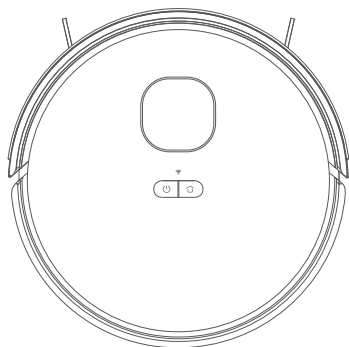

English

Español

For more details, please  
visit [www.iliferobot.com](http://www.iliferobot.com)

**ILIFE**



Dear Customer,

Thank you for purchasing ILIFE T10s robotic vacuum cleaner!  
You've joined the millions of people who clean with robots - the smarter way to get it done.

Please take a few moments to read this manual and get acquainted with your robot, to get the best performance from your robot. If you have any problems with your robot please do not hesitate to contact our customer service or visit our website at [www.iliferobot.com](http://www.iliferobot.com) for more information.

Stay connected with us on Facebook and Twitter to enjoy these exclusive benefits:

- Get support tailored to your specific robot, including answers to questions, maintenance tips, video demos, live chat and more.
- Get product updates and other valuable information among the first to find out about new robots, exclusive discounts and special promotions.

Connect with us right now at  
Facebook: [facebook.com/iliferobotics](https://facebook.com/iliferobotics)  
Twitter: [twitter.com/ILIFEROBOTICS](https://twitter.com/ILIFEROBOTICS)

Enjoy a thorough cleaning every day!  
Best regards,  
ILIFE Innovation

## ILIFE Customer Service



**1-800-631-9676** (Toll free for North America)  
Mon-Fri: 8:00 am - 7:00 pm CST



[service\\_us\\_ca@iliferobot.com](mailto:service_us_ca@iliferobot.com)

## Table of Contents

<b>Safety Instruction</b> .....	4
<b>Product Composition</b> .....	6
List of accessories .....	6
Main machine .....	7
Indicator status .....	7
Sensor and structure .....	8
Auto-empty station .....	9
Dust bin assembly .....	9
<b>Installation</b> .....	10
Precautions .....	10
Mopping function .....	14
<b>APP Connection</b> .....	15
Preparation before connection .....	15
Hotspot network .....	16
<b>How To Use</b> .....	18
Use Instructions .....	18
Intelligent cleaning (default mode) .....	20
Cleaning as required .....	21
Cleaning of selected area .....	22
Cleaning of defined area .....	23
Restricted area setting .....	24
Scheduled cleaning .....	25
DND mode .....	25
Other APP functions .....	25

<b>Routine Maintenance</b> .....	26
Roller brush .....	26
Side brush .....	27
Dust bin and filter .....	28
Wash the dust bin .....	29
Clean the infrared obstacle avoidance sensor .....	30
Clean the cliff sensor .....	30
Clean the charging contact .....	30
Clean the signal emission region on the Auto-empty station .....	31
Battery .....	31
Firmware upgrade .....	31
How to change the dust bag .....	32
Clean the Auto-empty station dust channel .....	33
Clean the Auto-empty station infrared sensor/Charging contact shrapnel .....	33
<b>Product Specification</b> .....	34
Main unit .....	34
Auto-empty station .....	34
<b>Common Problems</b> .....	35
<b>Troubleshooting</b> .....	37

## Safety Instructions

---

### Use Restrictions

- This product can only be used for floor cleaning at home. Please do not use it in outdoor (such as an open balcony), non-ground (such as a sofa), commercial or industrial environment.
- Do not use the machine in the suspended environments without protective fences (such as duplex floor, open balcony, and top of furniture).
- Please hang up the ground wires at home before use to avoid dragging the wires when the main unit is running.
- Please put away the fragile articles and sundries (such as vases, plastic bags, etc.) on the ground; otherwise, the machine may be blocked or a slight collision may cause damage to valuables at home.
- Do not allow people (including children) with physical, mental or perceptual disabilities to use or operate this product.
- Do not allow children to use the machine as a toy. When the machine is working, please keep children and pets away from the machine.
- Keep the cleaning brush out of reach of children.
- Do not place any objects (including children and pets) on the stationary or moving machine.
- When the machine is working, keep the hair, fingers and other parts of human body or pet away from the dust suction inlet of the machine.
- Do not use the machine to clean long-haired carpets. Some dark carpets might not be cleaned normally).
- Do not use the machine to clean long-haired carpets. Some dark carpets might not be cleaned normally).
- Do not use the machine to vacuum hard or sharp objects, such as decoration waste, glass, nails, etc.
- Do not use the protective cover of the laser ranging sensor or bumper as a handle to carry the machine.

## **Safety Instructions**

---

- Please clean or maintain the machine and charging base when the machine is shut down or powered off.
- Do not use a damp cloth or any liquid to wipe any part of the machine.
- Please follow the instructions in the manual when using the machine. Any loss and injury caused by improper use of the product shall be borne by the user.
- Do not use the mopping function on the carpet or the top of furniture.
- Remove the water tank when charging the machine.

## **Battery and Charging**

- Do not use any third-party batteries, charging bases or chargers.
- Do not disassemble, repair or modify the battery or charging base without permission.
- Do not place the charging base near heat sources such as heating radiators.
- Do not use a damp cloth or wet hands to wipe or clean the charging base strapne
- Dispose of used batteries properly and send them to professional recycling agencies.
- If the power line is damaged or broken, stop using it immediately and buy a new one through official channels.
- When transporting the product, ensure that the machine is shut down, and it is recommended to use the original packaging box for packaging.
- If you do not use the machine for a long time, fully charge it, power if off and put it in a cool and dry place. The machine shall be charged at least once every three months to avoid damage to th e battery due to over- discharge.

## Product Composition

---

### List of accessories

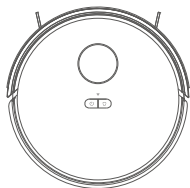

Robot

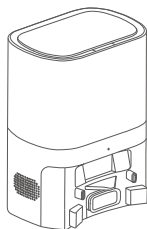

Auto-empty station

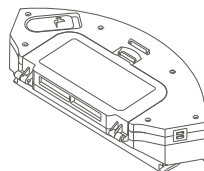

2 in1 Dustbin & water tank

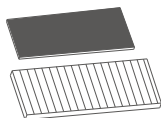

High-efficiency filter+ sponge

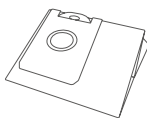

Dust bag

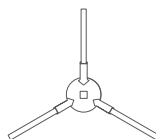

Side brush

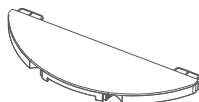

Mopping support



Mop cloth



Cleaning tool



User Manual



## Product Composition

### Main machine

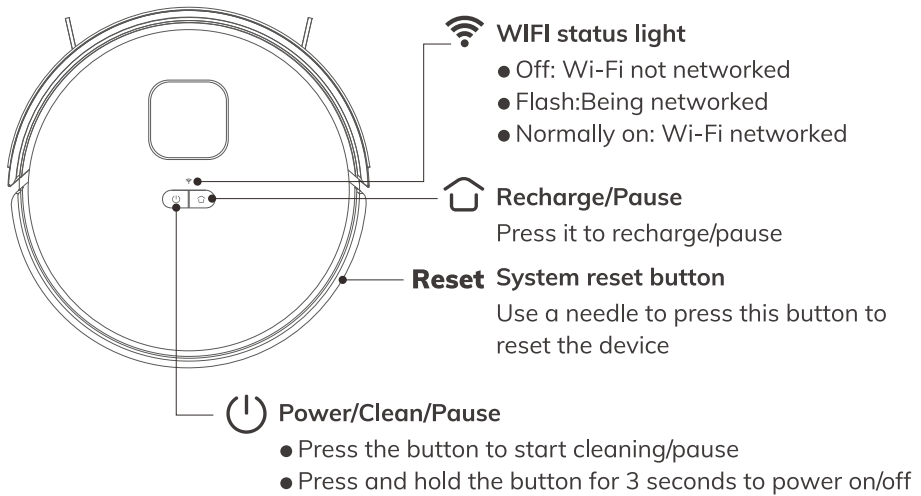

### Indicator status

Status	light
Cleaning	Blue light on
Recharging	Blue light on
Charging	Blue light flickering
Low power	Red light flickering
Fullycharged	Blue light on
Alarming	Red light flickering
Standby	Off

## Product Composition

---

### Sensor and structure

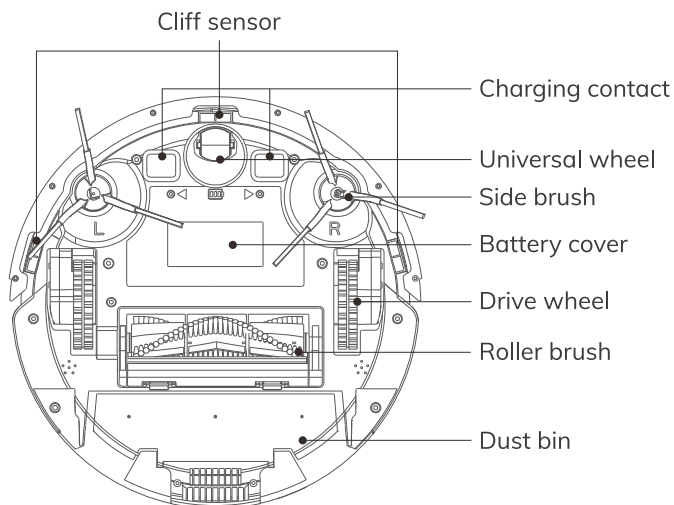
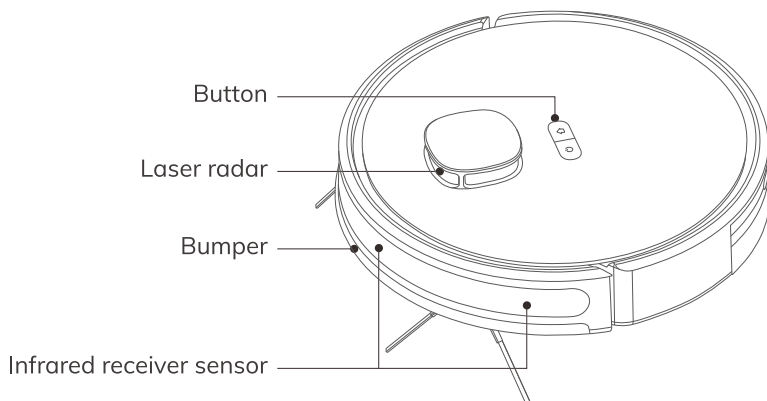

## Product Composition

---

### Auto-empty station

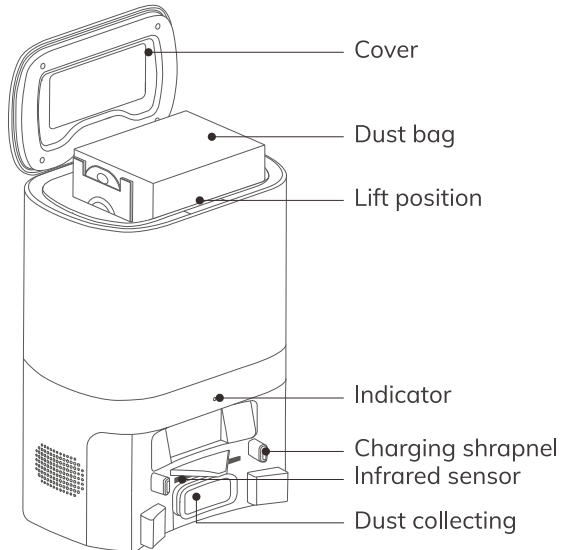

### Dust bin assembly

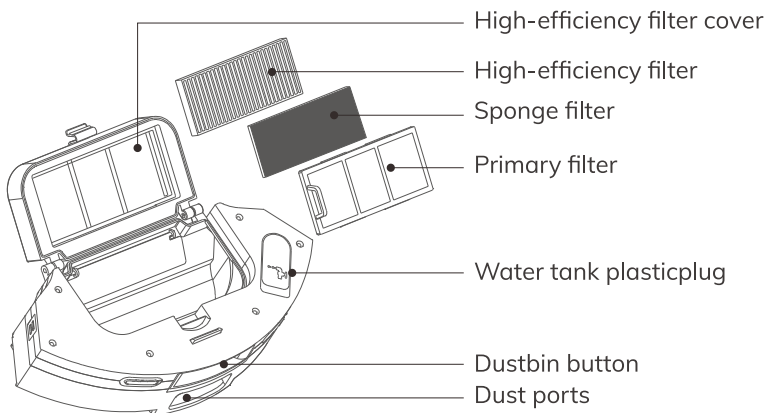

## Installation

### Precautions

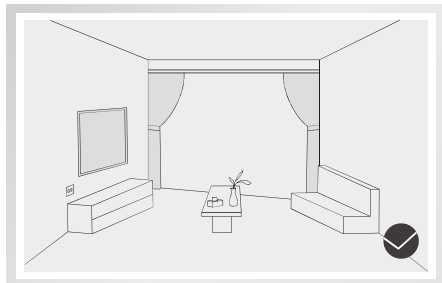
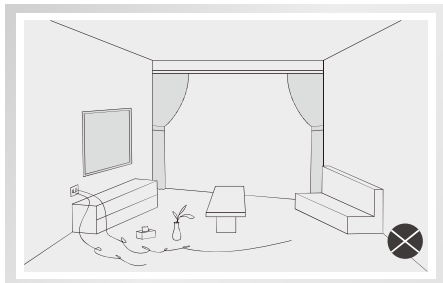

Before starting the vacuum cleaner, clean up wires and sundries scattered on the ground, and remove easy-to-fall, fragile, valuable and potentially dangerous items. Avoid being entangled, stuck, dragged or knocked down by the main unit; otherwise, personal injury or property damage may be caused.

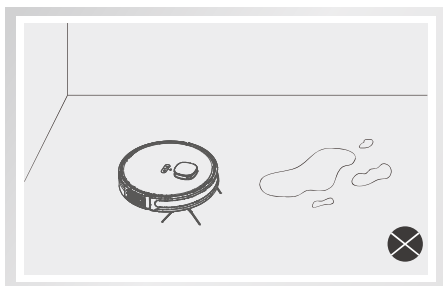

Do not use the robot to clean liquid

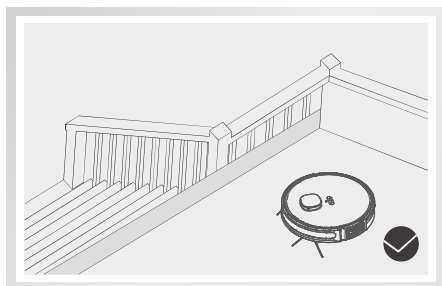

When used in a suspended circumstance, it shall be protected by rails to avoid accidental falling or pushing other articles from falling; otherwise, personal or property damage may be caused.

## Installation

- 1 Remove the protection material from both sides of the robot

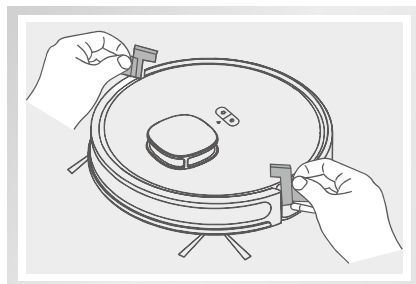

- 2 Install side brushes

Put the left side brush (L) and right side brush (R) against the letters L and R on the bottom shell respectively, press down, you will hear a “click” sound, and it means that the side brushes are installed in place.

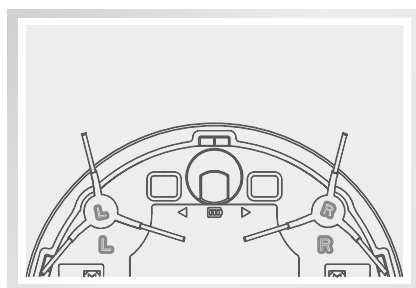

- 3 Take out and place the Auto-empty station on a flat floor against the wall and tidy up the redundant wires

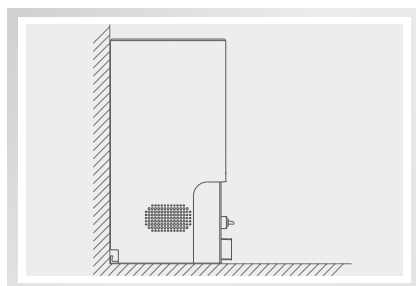

## Installation

- 4 Clean up the sun dries around the station and connect the power supply that meets the requirement of electricity consumption

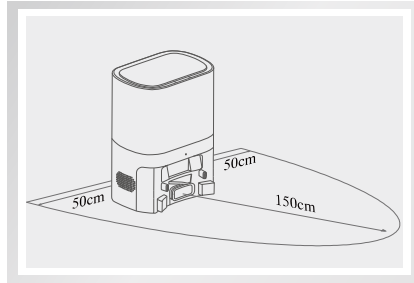
**Note:**

Ensure space more than 0.5m from the left and right to the charging base and 1.5m in front of the charging base.

- 5 Do not move the charging base at will; avoid direct sunlight on the charging base

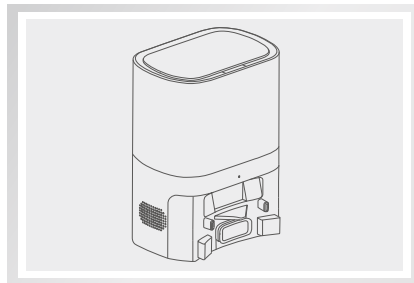
**Note:**

The sunlight may interfere the recharging signal, which may cause the robot vacuum cleaner to fail to return to the charging base.

## Installation

---

### 6 Power on and charge

Press and hold the  button to power on. When the indicator light is normally on, put the main unit against the charging base for charging; when you hear the voice of “Start charging”, it means that the robot is being charged successfully.

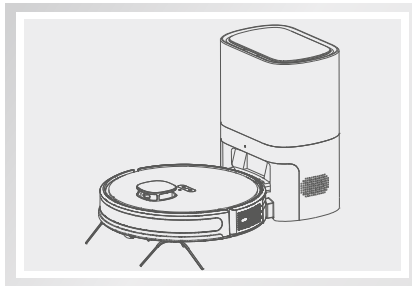

**Note:**

If the battery is at low level, the robot cannot be powered on. Please put the robot vacuum cleaner on the charging base and the device will be powered on automatically.

## Installation

### Mopping function

- 1 Open the water injection cover, add appropriate amount of water and then cover tightly, please do not add any detergent.
- 2 Put the water tank back into the robot

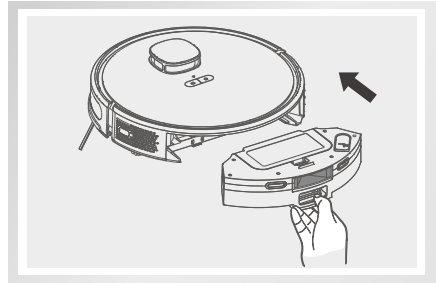
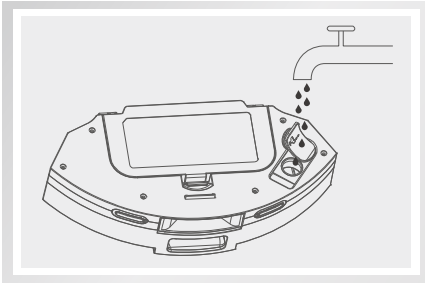

- 3 Install the mop on the mop support

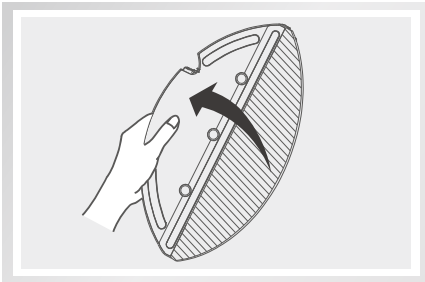

- 4 Install the mop support

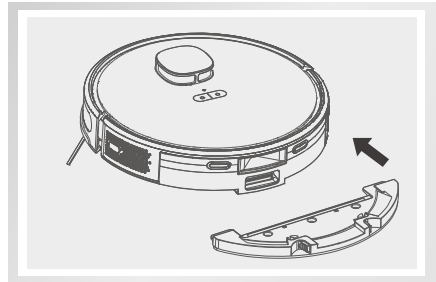



## APP Connection

### Preparation before connection



🔍 tuya smart



- 1 Scan the QR code to install the app.
- 2 Or search "tuya smart" in the mobile app store to download the APP.
- 3 Register and log into the APP.



- 4 Click "Add a device" or "+" in the top right corner.





- 5 Select small household appliance - robot vacuum cleaner (Wi-Fi).



- 6 Select 2.4GHz Wi-Fi network and enter the password.

## APP Connection

### Hotspot network

- 1 First start the robot vacuum cleaner, press and hold the  and  keys on the main unit at the same time for 3 seconds, and when you hear the voice prompt of "AP mode" and the WiFi indicator light flashes slowly, it means that the machine has entered the networking mode.

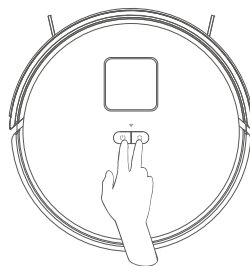

- 2 Select hotspot networking mode and confirm that the WiFi indicator light on the robot vacuum cleaner flashes slowly.



- 3 Read the instructions for hotspot connection carefully and select to connect.

## APP Connection

### Hotspot networking (compatible mode)

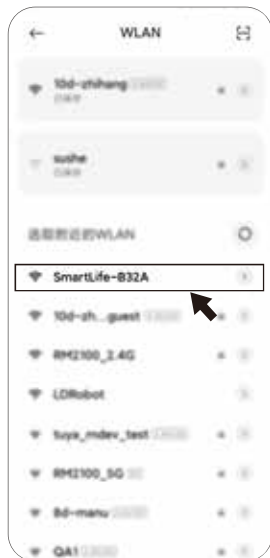

- 4 Select the robot vacuum cleaner hotspot with the beginning of SmartLife, and after connecting successfully, return to the APP.
- 5 Wait for the APP to connect to the robot vacuum cleaner.
- 6 After connecting successfully, enter the operation interface.

## How To Use

---

### Use Instructions

#### ① Power On / Power Off

Press and hold the  key for 3 seconds, and if the indicator light is lit on, it means the machine is started up successfully.

When the robot vacuum cleaner is in standby state, press and hold the  key for 3 seconds, and if the indicator light goes out, it means the machine is shut down.

**Note:**

The robot vacuum cleaner cannot be shut down during charging.

#### ② Cleaning / Pause

After startup, press the  key on the main unit or use the remote controller or mobile APP to start cleaning.

**Note:**

- The robot vacuum cleaner cannot be used to clean liquid.
- If the battery capacity is less than 15%, the robot cannot work; therefore, charge the machine before cleaning.
- When the battery capacity is less than 15% in the cleaning process, the device will automatically return to the charging base for charging.
- Please tidy up the wires (including the power line of charging base) on the ground before cleaning; otherwise, the wires may be dragged when the machine is cleaning which may cause power failure to electric appliances and damage items or wires.

## How To Use

---

### 3 Charge

Automatic mode: After finishing cleaning, the robot vacuum cleaner will automatically return to the charging base for charging.

Manual mode: In pause state, press the  key to start recharging or use the remote controller or mobile APP to start recharging.



**Note:**

If the robot vacuum cleaner fails to find the charging base, it will automatically return to the starting point; please manually put back the main unit on the charging base for charging.

### 4 Suction selection

Use the mobile APP to select energy-saving, standard and powerful modes (the default is standard mode)

## How To Use

### Intelligent cleaning (default mode)

The robot vacuum cleaner scans the working environment, generates a map and intelligently divides the areas. It will complete cleaning of each area one by one by filling along the Z shape behind the wall. After finishing cleaning, the robot vacuum cleaner will return to the charging base for charging. (In order to better build the map, the robot needs to start from the charging base at the first cleaning)

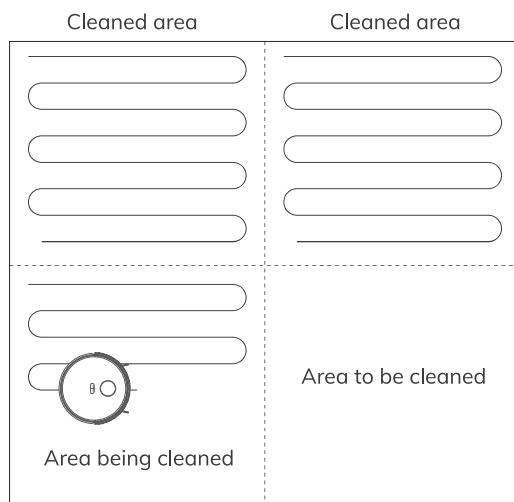
**Note:**

Do not move the main unit randomly and frequently during operation. After moving, please put the main unit near the original place. When starting the machine again, the device will try to reposition its coordinates; after positioning successfully, it will continue to work according to the planned path; if positioning fails, the device will give up the previous task, and build a new map for cleaning, but it might fail to recharge.

## How To Use

---

### Cleaning as required

Use the mobile APP to select the function of cleaning as required; select a point on the map and the robot vacuum cleaner will move to the designated position and clean a 1.6m×1.6m square area with itself as the center.

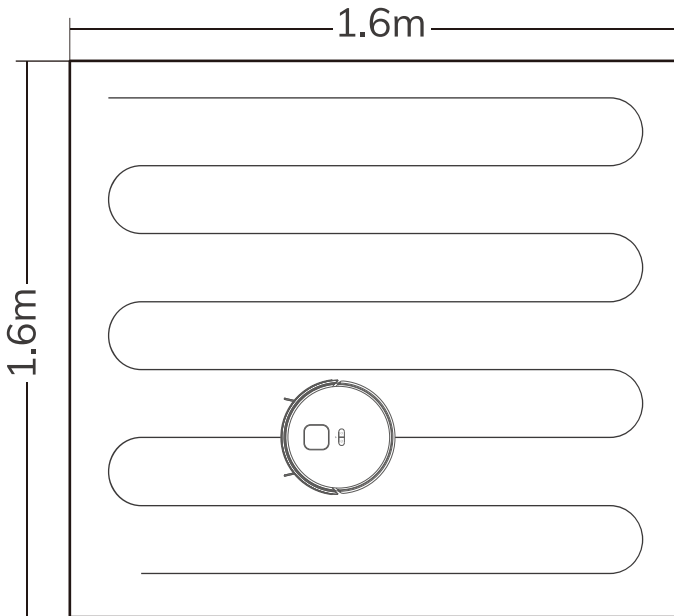

**Note:**

Before using this function, complete building of the map for the first cleaning in the mobile APP.

## How To Use

---

### Cleaning of selected area

Use the mobile APP to select the function of cleaning of selected area, select the area to be cleaned on the map and the robot vacuum cleaner will clean in the selected area.

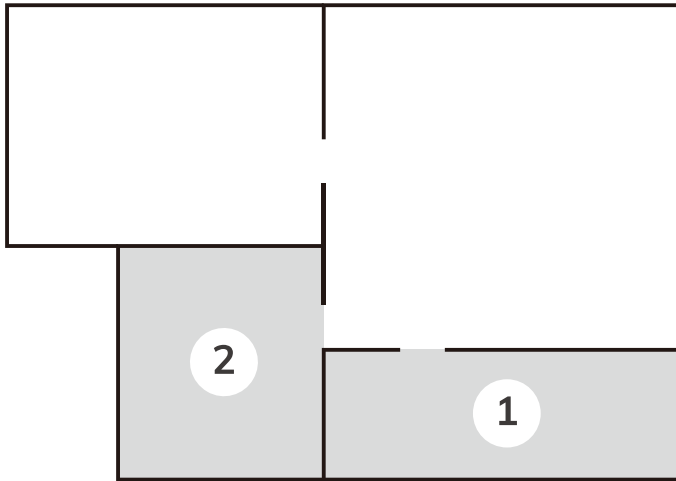
**Note:**

1. Before using this function, complete building of the map for the first cleaning in the mobile APP.
2. The main unit might enter the unplanned area, so please clear the obstacles on the ground around the planned area, and this area cannot play a role of safety isolation.



## How To Use

---

### Cleaning of defined area

Use the mobile APP to select the function of cleaning or defined area, select the area to be cleaned on the map and the robot vacuum cleaner will clean in the defined area.

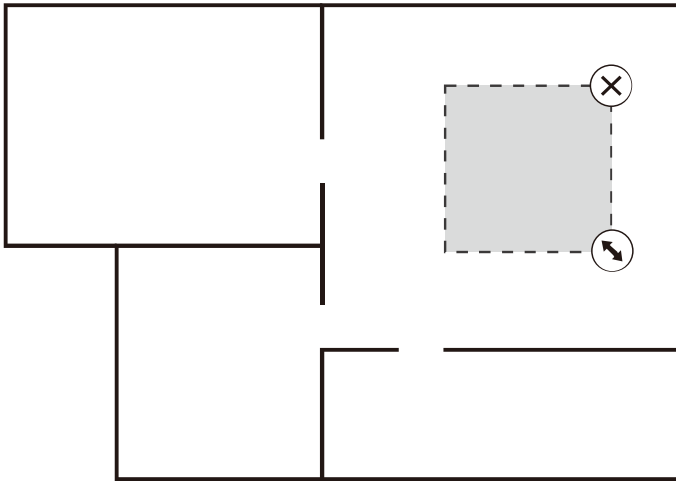
**Note:**

1. Before using this function, complete building of the map for the first cleaning in the mobile APP.
2. The main unit might enter the unplanned area, so please clear the obstacles on the ground around the planned area, and this area cannot play a role of safety isolation.

## How To Use

---

### Restricted area setting

Use the mobile APP to select the restricted area editing function, select and set the restricted area of cleaning on the map, and the machine will not enter the set area to clean.

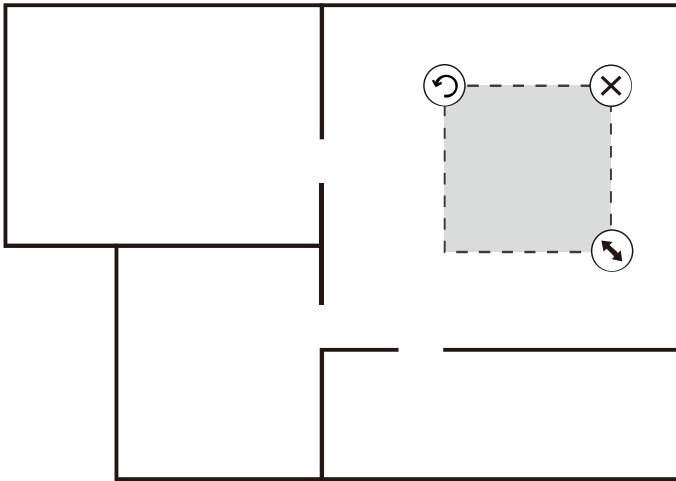
**Note:**

1. Before using this function, complete building of the map for the first cleaning in the mobile APP.
2. This function is only used to define the cleaning areas and cannot be used to block dangerous areas.
3. When moving the robot vacuum cleaner or there are obvious changes in your home environment, the map might become ineffective and the restricted area might be lost.

## How To Use

---

### Scheduled cleaning

After the setting of scheduled cleaning takes effect, the machine will automatically start to clean at the designated time, and automatically return to the charging base after finishing cleaning.

### DND mode

The default starting time period is 22:00-06:00, which can be modified or closed in your mobile APP.

During the DND time period, the robot vacuum cleaner will close the functions of automatic continuous cleaning, actively playing the voice, and timing.

### Other APP functions

Remote control	Real-time map updating
Look for robot	Language selection
Map management	Cleaning record viewing
Working mode selection	Consumables management
Partition area editing	Self-defining of cleaning sequence of areas
Area attribute customizing	

## Routine Maintenance

### Roller brush

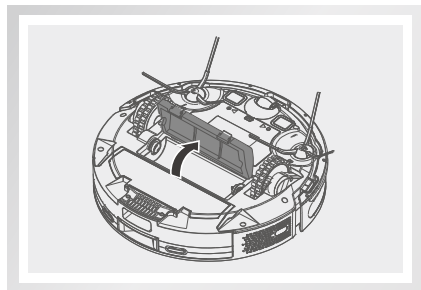

1 Turn over the machine, press the buckle on the roller brush cover and take out the cover plate of roller brush.

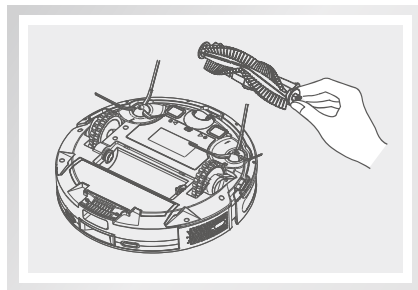

2 Take out the roller brush.

3 Use the clean brush to remove the dust in the cavity of main brush and roller brush and clear the entanglements on the roller brush.

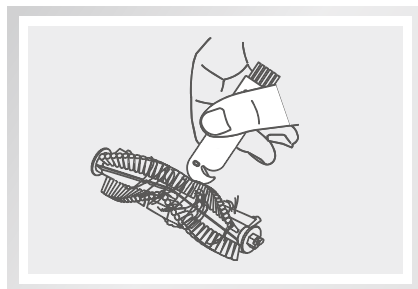
**Note:**

Recommended cleaning frequency: once a week.

## Routine Maintenance

---

### Side brush

- 1 Turn over the machine upward and pull out the side brush vertically.
- 2 Clear the entangled hairs and dirt and install back the side brush.
- 3 Align the side left brush (L) and right side brush (R) with the letters L and R on the bottom shell respectively, and press them down to install back the side brush.

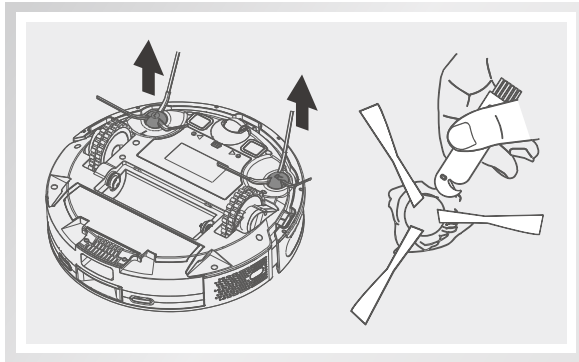

**Note:**

- It is recommended to replace the side brush every three months to ensure cleaning effect.
- Recommended cleaning frequency: once a week.

## Routine Maintenance

### Dust bin and filter

- 1 Press the dust bin button and draw out the dust bin.

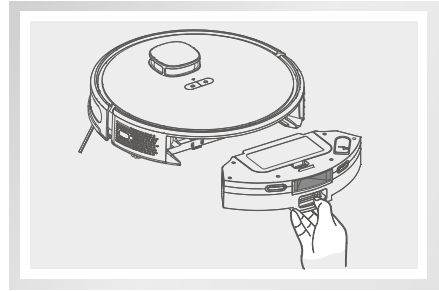

- 2 Press the dust bin switch and open the dust bin to dump the rubbish.

**Note:**

Recommended cleaning frequency: after cleaning.

## Routine Maintenance

### Wash the dust bin

- 1 After use for a long time, take down the sponge and high-efficiency filter.
- 2 Flush the primary filter, dust bin and sponge under the water tap (the high-efficiency filter cannot be washed with water).
- 3 After washing, shake off the water drops, dry the filter and dust bin in the air, and they can be used only after they are completely dry.

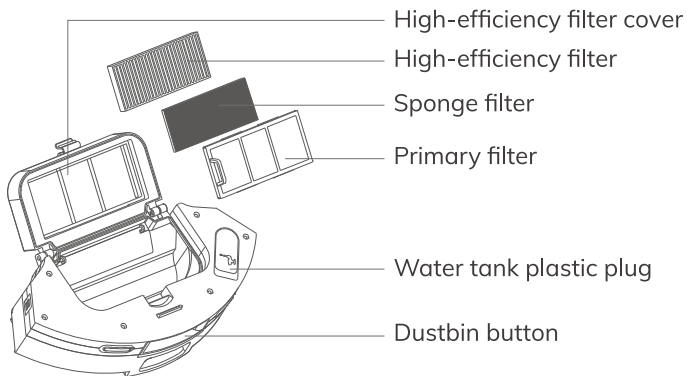

#### Note:

- Wash with clean water and do not add any detergent.
- Do not use brush but use fingers to clean the filter.
- The filter shall be dried in the air for at least 24 hours so that it can be dried thoroughly.
- It is recommended to replace the filter every three months.
- Recommended cleaning frequency: once a week.

## Routine Maintenance

Clean the infrared obstacle avoidance sensor

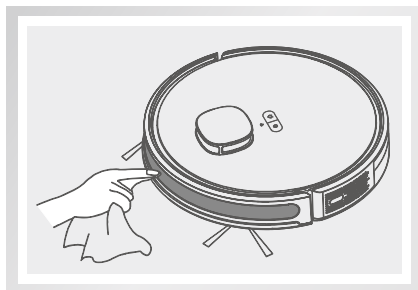

Clean the cliff sensor

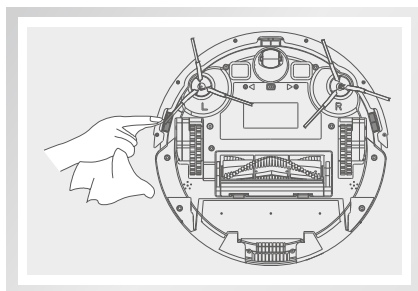

Clean the charging contact

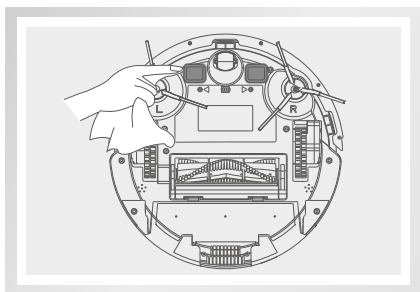

**Note:**

Recommended cleaning frequency: once a month.



## Routine Maintenance

---

### Clean the signal emission region on the Auto-empty station

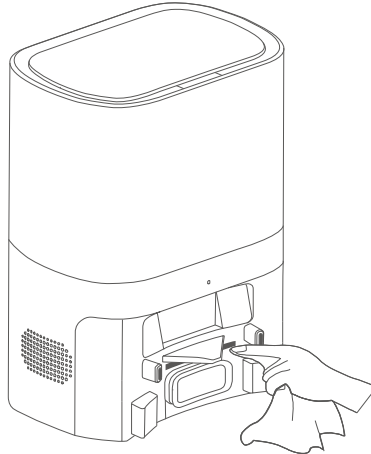

**Note:**

Recommended cleaning frequency: once a month.

## Battery

Rechargeable high-performance lithium ion battery pack is built in the main unit. To maintain the battery performance, please maintain the main unit in charging state during daily use.

If the machine is not used for a long time, it shall be shut down for storage, and charged every three months to avoid damage to the battery due to over-discharge.

## Firmware upgrade

Enter the firmware upgrade function through the mobile APP. After new firmware is detected, upgrade according to the prompt guidance. The battery capacity shall not be less than 50% during firmware upgrade. It is recommended to place the device on the charging base during upgrade.

## Routine Maintenance

### How to change the dust bag

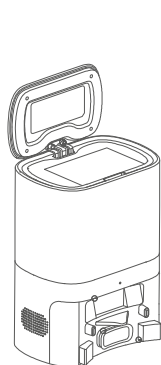

1

1. Unplug the power and open the Auto-empty station cover.

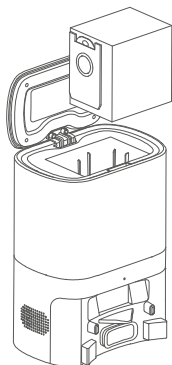

2

2. Pull up dust bag handle.

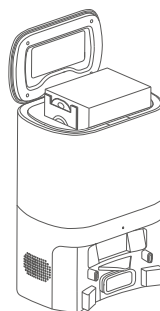

3

3. Remove the dust bag from the station.

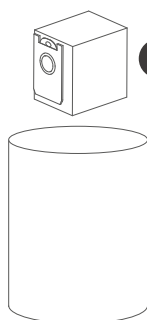

4

4. Throw the used dust bag in to the trash can.

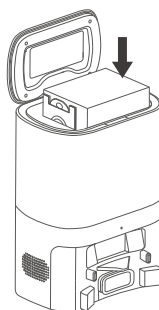

5

5. Install the new dust bag into the station and ensure that the dust bag handle is not pulled out.

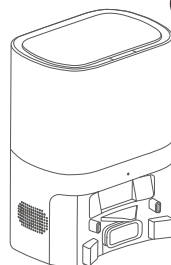

6

6. After covering the Auto-empty station, switch on the power supply.

## Routine Maintenance

### Clean the Auto-empty station dust channel

If the station indicator blinks red after replacing the dust bag, please unplug it. Reverse the station, through the dust channel perspective window, check whether the dust channel of the station is blocked. If the dust channel is blocked, remove the dust channel perspective window with a screwdriver according to the following figure.



#### Caution

Violent disassembly is strictly prohibited. Please reinstall it after cleaning.

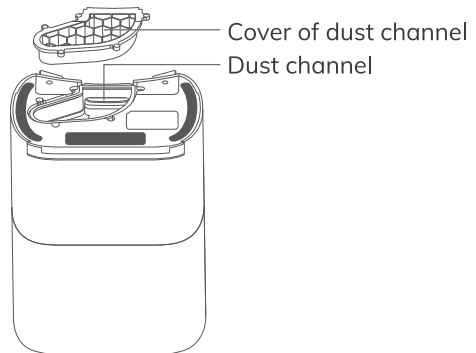

### Clean the Auto-empty station infrared sensor/ Charging contact shrapnel

Gently wipe the two areas regularly with a clean, soft, dry cloth. It is recommended to clean them once a month.

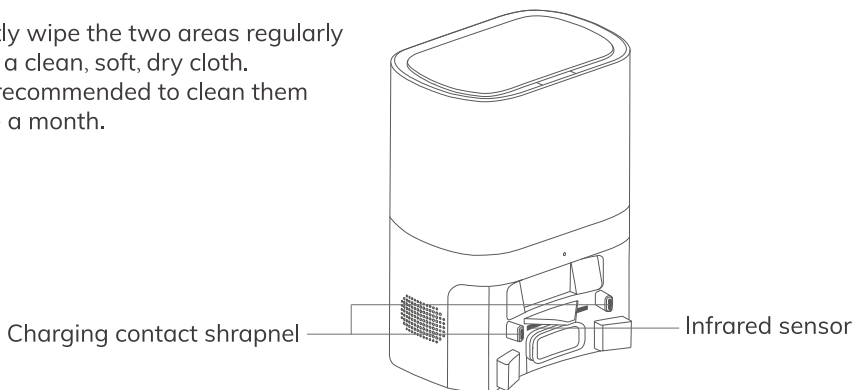

## Product Specification

---

### Main unit

Product name	Robot vacuum cleaner
Product model	T10s
Overall dimension	320X320X93mm
Net weight	2.8kg
Battery	3200mAh
Rated voltage	14.4V
Rated power	42W
Charging time	300min
Capacity of dustbin	240ml
Capacity of water tank	250ml

### Auto-empty station

Product name	Auto-empty station
Product model	T10s
Overall dimension	320X240X165mm
Net weight	2.7kg
Rated Input	100-240V~50/60HZ
Rated Output	19V = 1A
Rated power	680W

## Common Problems

Problem	Solution
Failed to power on the machine.	The battery power is insufficient. Please place the machine on the docking station, and align with the charging electrode. The machine will be automatically powered on.
Failed to charge the machine.	<ul style="list-style-type: none"> <li>● Move the machine away from the docking station, and check whether the indicator of the docking station is on. Make sure that both ends of the power adapter are properly connected.</li> <li>● The docking station is not in proper contact with the machine. Please clean the docking station shrapnel and the charging contact on the machine, or push the side brush to one side.</li> </ul>
Failed to return to the docking station.	The machine is too far away from the docking station. Try to place the machine near the docking station.
Failed to return to the docking station.	Power off the machine and then on again.
Failed to return to the docking station.	The roller brush, side brushes, or wheels may be entangled with foreign objects. Please clean them after stopping the machine.
The cleaning performance is degraded, or ash is dropped.	<ul style="list-style-type: none"> <li>● The dust box is blocked. Clean the dust box.</li> <li>● The filter is full. Clean or replace the filter.</li> <li>● The roller brush is entangled with foreign objects. Clean the roller brush.</li> </ul>

## Common Problems

---

Problem	Solution
The Wi-Fi network cannot be connected.	<ul style="list-style-type: none"><li>● The Wi-Fi signal is not good. Ensure that the machine is located in a place with good Wi-Fi signals.</li><li>● The Wi-Fi connection is abnormal. Reset the Wi-Fi settings, download the app of the latest version, and try to connect to the Wi-Fi network again.</li><li>● The password is incorrect.</li><li>● This machine supports only the 2.4 GHz band.</li></ul>
Scheduled cleaning cannot be carried out.	The power is insufficient. Scheduled cleaning will be started only when the remaining power is 15% or above.
Is any power consumed if the machine always stays at the docking station?	The power consumption is extremely low when the machine always stays at the docking station. This helps to keep the battery in the best performance.
Is it necessary to charge the battery for 16 hours when the machine is used for the first three times?	The lithium battery does not have a memory effect. It can be used instantly after it is fully charged. There is no need to wait.

## Troubleshooting

Error Prompt	Solution
Error 1 : Insert the dustbin	Cleaning is triggered when the dust bin is taken out; please reinstall the dust bin.
Error 2: Put the machine on the floor before starting	You may pick up the machine; or the machine is suspended; please move the machine to a flat ground and start it again.
Error 3: Please lay the machine flat on the ground and then start it	The machine tilts; please move the machine to a flat ground and then start it.
Error 4: Please check whether the front bumper is stuck	The edge or collision sensor is stuck; please push the bumper left and right to confirm that it is not stuck.
Error 5: Low battery; please charge	Put the main unit on the charging base for charging.
Error 6: The machine is trapped	Please move the machine to an open ground and then start it.
Error 7: Please check whether the wheel is stuck	The main wheel is stuck or entangled; please check the main wheel and remove the foreign matters.
Error 8: Please check whether the rolling brush is stuck	The rolling brush is entangled or stuck; please check the rolling brush and remove the foreign matters.
Error 9: Please check whether the side brush is stuck	The side brush is entangled or stuck; please check the side brush and remove the foreign matters.

