

# SPLIT TYPE ROOM AIR CONDITIONER

## OPERATION MANUAL



HSU12T-TQG3BE-FS

HSU12T-TQS3BE-FS

HSU12T-TQB3BE-FS

HSU12T-TQG2BE-FS

HSU12T-TQS2BE-FS

HSU12T-TQB2BE-FS

HSU18T-TQG3BE-FS

HSU18T-TQS3BE-FS

HSU18T-TQB3BE-FS

HSU18T-TQB2BE-FS

HSU18T-TQG2BE-FS

HSU18T-TQS2BE-FS

HSU10T-TCW3BE-FS

HSU12T-TCW2BE-FS

HSU12T-TCS3BE-FS

HSU12T-TMB3BE-FS

HSU18T-NMR2BE-FS

HSU18T-NCW2BE-FS

HSU18T-NCW3BE-FS

HSU18T-NMB3BE-FS

HSU18T-WKT3BE-FS

HSU19T-TXS3BE-FS

HSU22T-TXW1BE-FS

HPU24V-GCW1BE-FS

HSU36TG-NCW2BE-FS

HSU13T-TQS3BE-FS

HSU11T-TQS3BE-FS

HSU20SD-TXS3BE-FS

HSU24T-TXS1BE-FS

HSU36T-TXS1BE-FS

HSU50T-TBS2BE-FS

HSU50T-TBG2BE-FS

HSU50T-TMS2BE-FS

HSU50T-TMG2BE-FS

HSU50T-TMW2BE-FS

HSU50T-TMB2BE-FS

HSU50T-TBB2BE-FS

HSU18T-NCW2BE-FS

HSU18T-NCR2BE-FS

HSU18T-NCB2BE-FS

## Contents

PARTS AND FUNCTIONS	1
OPERATION	2-4
MAINTENANCE	5
CAUTIONS	6-7
TROUBLE SHOOTING	7

- Please read this operation manual before using the air conditioner.  
Keep this operation manual for future reference.

0010589123

# Parts and Functions

## Indoor Unit

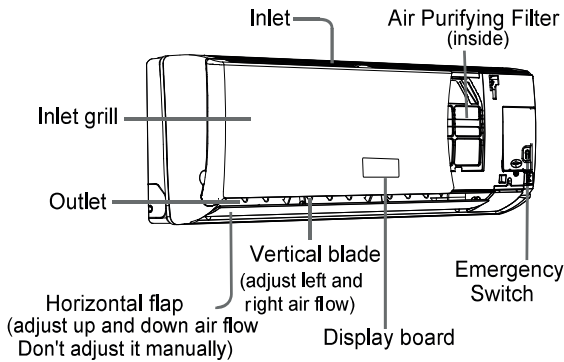

### Display board

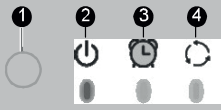

- 1 Remote signal receiver  
(A beeping sound is generated when a signal from remote controller is received.)
- 2 Power indicator (Lights up when unit starts.)
- 3 Timer mode indicator  
(Lights up when Timer operation is selected.)
- 4 Operation mode indicator (lights up when the compressor is on.)

### Display board

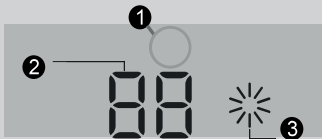

- 1 Signal receiver
- 2 Setting temp. display
- 3 Operation mode indicator

### Display board

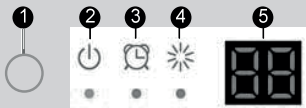

- 1 Remote signal receiver  
(A beeping sound is generated when a signal from remote controller is received.)
- 2 Power indicator (Lights up when unit starts.)
- 3 Timer mode indicator  
(Lights up when Timer operation is selected.)
- 4 Operation mode indicator (lights up when the compressor is on.)
- 5 Ambient temp display  
When receiving the remote control signal, display the set temperature.

Actual inlet grill may vary from the one shown in the manual according to the product purchased

## Outdoor Unit

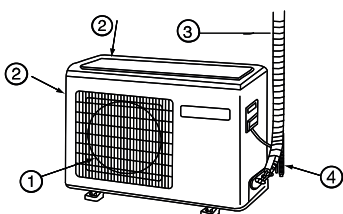

- 1 OUTLET
- 2 INLET
- 3 CONNECTING PIPING AND ELECTRICAL WIRING
- 4 DRAIN HOSE

## Remote controller

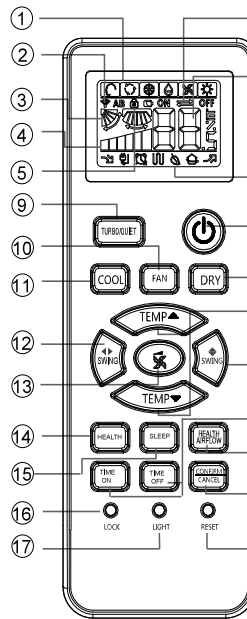

### 1. Mode display

Operation mode	COOL	DRY	FAN
Remote controller			

### 2. Signal sending display

### 3. SWING display

### 4. FAN SPEED display

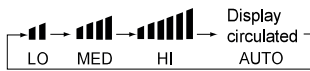

### 5. LOCK display

6. TIMER OFF display  
TIMER ON display
7. TEMP display
8. Additional functions display

Operation mode	QUIET	SLEEP	HEALTH	TURBO
Remote controller				

9. TURBO/QUIET button
10. FAN button
11. COOL button
12. SWING LEFT/RIGHT button  
(Manual adjustment of some units)
13. FAN SPEED button
14. HEALTH button  
(Healthy function is not available for some units.)

### 15. SLEEP button

### 16. LOCK button

### 17. LIGHT button

Control the lightening and extinguishing of the indoor LED display board.

### 18. POWER ON/OFF button

### 19. DRY button

### 20. TEMP button

### 21. SWING UP/DOWN button

### 22. TIME OFF/ON button

### 23. HEALTH AIR FLOW button

### 24. CANCEL/CONFIRM button

Function: Setting and cancel to the timer and other additional functions.

### 25. RESET button

When the remote controller appears abnormal, use a sharp pointed article to press this button to reset the remote.

Healthy function is not available for some units.

## Loading of the battery

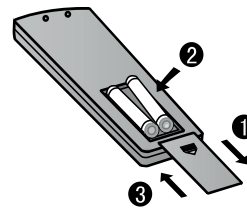

### 4 Load the battery, then put on the cover again.

Note:

- The distance between the signal transmission head and the receiver hole should be within 7m without any obstacle as well.
- When electronic-started type fluorescent lamp or change-over type fluorescent lamp or wireless telephone is installed in the room, the receiver is apt to be disturbed in receiving the signals, so the distance to the indoor unit should be shorter.
- Full display or unclear display during operation indicates the batteries have been used up. Please change batteries.
- If the remote controller can't run normally during operation, please remove the batteries and reload several minutes later.

# Operation

## Base Operation

Remote controller

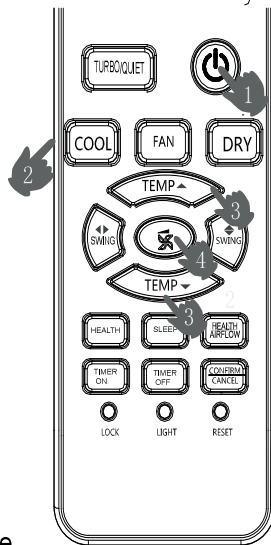

### 1. Unit start

Press ON/OFF on the remote controller, unit starts.

### 2. Select operation mode

COOL button: Cooling mode  
FAN button: Fanning mode  
DRY button: Dehumidify mode

### 3. Select temp. setting

Press TEMP▲/TEMP▼ button

TEMP▲ Every time the button is pressed, temp. setting increase 1°C, if kept depressed, it will increase rapidly

TEMP▼ Every time the button is pressed, temp. setting decrease 1°C, if kept depressed, it will decrease rapidly

Select a desired temperature.

### 4. Fan speed selection

Press FAN button. For each press, fan speed changes as follows:

Remote controller:

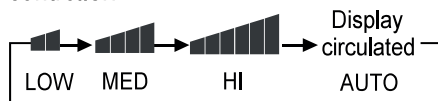

Air conditioner is running under displayed fan speed. When FAN is set to AUTO, the air conditioner automatically adjusts the fan speed according to room temperature.

Operation Mode	Remote Controller	Note
COOL		In COOL mode, the AC unit will emit air Cool according to the remote setting on the temperature display. The unit will return to ambient temperature after a moment ago.
DRY		In DRY mode, when room temperature becomes lower than temp. setting + 2°C, unit will run intermittently at LOW speed regardless of FAN setting.
FAN		In FAN operation mode, the unit will not operate in COOL or HEAT mode but only in FAN mode. AUTO is not available in FAN mode. And temp. setting is disabled. In FAN mode, sleep operation is not available.

## Emergency operation and test operation

### Emergency Operation:

- Use this operation only when the remote controller is defective or lost, and with function of emergency running, air conditioner can run automatically for a while.
- When the emergency operation switch is pressed, the "Pi" sound is heard once, which means the start of this operation.
- When power switch is turning on for the first time and emergency operation starts, the unit will run automatically in the following modes:

Room temperature	Designated temperature	Timer mode	Fan speed	Operation mode
Above 23°C	26°C	No	AUTO	COOL



- It is impossible to change the settings of temp. and fan speed, it is also not possible to operate in timer or dry mode.

### Test operation:

Test operation switch is the same as emergency switch.

- Use this switch in the test operation when the room temperature is below 16°C, do not use it in the normal operation.
- Continue to press the test operation switch for more than 5 seconds. After you hear the "Pi" sound twice, release your finger from the switch: the cooling operation starts with the air flow speed "Hi".
- Under this operation mode, the fan motor of indoor unit will run in high speed.

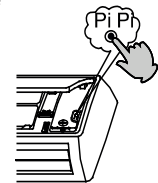

## Air Flow Direction Adjustment

### 1. Status display of air flow

Horizontal flap

Pos.1 (Auto swing)

Initial state

Pos.2 No initial state displayed on remote controller, the vertical flap will be fixed on the current position

### 2. Left and right air flow adjustment

For each press of SWING button, remote controller displays as follows:

remote controller:



Note: In some model: The remote has the button SWING button, But the AC doesn't have the left and right air flow auto adjustment function. in this condition, change the direction of vertical blades manually.

### Cautions:

- When adjusting the flap by hand, turn off the unit.
- When humidity is high, condensate water might occur at air outlet if all vertical louvers are adjust to left or right.
- It is advisable not to keep horizontal flap at downward position for a long time in COOL or DRY mode, otherwise, condensate water might occur.

# Operation

## ■ Sleep Operation

Before going to bed, you can simply press the SLEEP button and unit will operate in SLEEP mode and bring you a sound sleep.



### Operation Mode

#### 1. In COOL, DRY mode

1 hours after SLEEP mode starts, temp. will become 1°C higher than temp. setting. After another 1 hours, temp. rises by 1°C further. The unit will run for further 6 hours then stops. Temp. is higher than temp. setting so that room temperature won't be too low for your sleep.

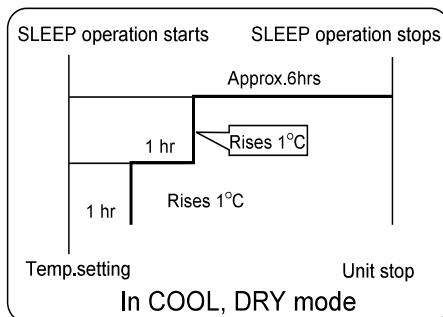

#### 2. In FAN mode

It has no SLEEP function.

#### 3. Set the wind speed change when sleeping

If the wind speed is high or middle before setting for the sleep, set for lowering the wind speed after sleeping. If it is low wind, no change.

## Note

When TIMER ON is set, the sleeping function can't be set up. When TIMER OFF is set, the sleeping function can be set up.

## ■ TURBO/QUIET Operation

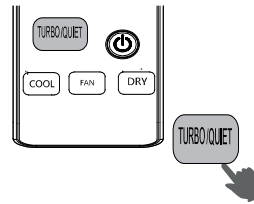

When you need fast cool or fast dehumidification, you can choose the Turbo function; when you sleep, read, you can choose Quiet function.

Press the **TURBO/QUIET** button, you can switch the "Turbo" and "Quiet" function easily. Every press, the remote controller will switch as below

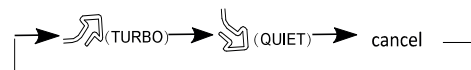

When running in Turbo, the fan speed is the highest, when running in Quiet, the fan speed is super slow.

## ■ HEALTH Operation

It has no HEALTH function.

# Operation

## Dry Operation

Press "DRY" Button, when the LCD displays ,

Dry Mode is set.

In Dry mode, compressor will stop to operate when the room temperature is below the setting temperature. If the room temperature is higher than the setting temperature, the logic circuit will control the operation of compressor and indoor fan speed, in order to cause dew formation on cooling coil to obtain the effect of dehumidification. In dry mode, it is normal that the indoor fan speed is lower than other operation mode.

The sequence of ON or OFF does not related to the setting sequence. But, it related to period set.

If set ON 4hr, OFF 5hr, the sequence will be

ON -> OFF. Means, ON after 4hrs, OFF after 1hr.

If set ON 7hr, OFF 3hr, the sequence will be

ON <- OFF. Means, OFF after 3hrs, ON after off 4hrs.

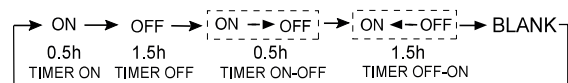

## Fan Operation

Press "FAN" Button, when the LCD displays , Fan Mode is set.

In Fan mode, the Fan speed is pre-set at low speed, and the compressor does not start.

In Fan mode, the LED displays 24 or 26.

## Health airflow Operation

1. Press  to starting

Setting the comfort work conditions.

2. The setting of healthy airflow function

Press button to select "Healthy airflow", the remote

controller will switch as below



Notice: Do not direct the flap by hand. Otherwise, the grill will run incorrectly. If the grill is not run correctly, stop for a minute and then start, adjusting by remote controller.

Note:

1. After setting the healthy airflow function, the position grill is fixed.

2. In cooling, it is better to select the  mode.

3. In cooling and dry using the air conditioner for a long time under the high air humidity, condensate water may occur at the grill.

## Timer On/Off On-Off Operation

1. Set ON timer.

Press "ON" to activate the screen or block the emitter and press "ON".

Press "TIME ON", set the duration (hour).

Press "CONFIRM/CANCEL".

2. Set OFF timer.

Press "TIME OFF", set the duration.

Press "CONFIRM/CANCEL".

3. Set ON/OFF timer.

Press "ON" to activate the screen or block the emitter and press ON.

Press "TIME ON" & set the duration.

Press "CONFIRM/CANCEL".

Press "TIME OFF" & set the duration.

Press "CONFIRM/CANCEL".



# Maintenance

## For Smart Use of The Air Conditioner

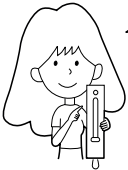
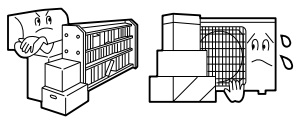
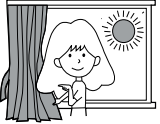
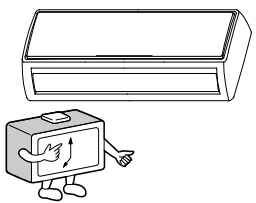
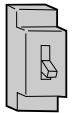
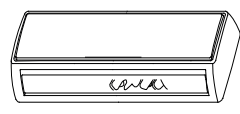
<p>Setting of proper room temperature.</p>  <p>Proper temperature</p>	<p>Do not block the air inlet or outlet.</p> 
<p>Close doors and windows during operation.</p>  <p>During cooling operation prevent the penetration of direct sunlight with curtain or blind</p>	<p>Use the timer effectively.</p> 
<p>If the unit is not to be used for a long time, turn off the power supply main switch.</p>  <p>OFF</p>	<p>Use the louvers effectively.</p> 

### Remote Controller



Do not use water, wipe the controller with a dry cloth. Do not use glass cleaner or chemical cloth.

### Indoor Body

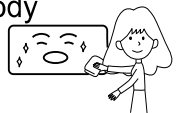

Wipe the air conditioner by using a soft and dry cloth. For serious stains, use a neutral detergent diluted with water. Wring the water out of the cloth before wiping, then wipe off the detergent completely.

### Do not use the following for cleaning



Gasoline, benzene, thinner or cleanser may damage the coating of the unit.



Hot water over 40°C (104°F) may cause discoloring or deformation.

### Air Filter cleaning

- Open the inlet grill by pulling it upward.
- Remove the filter. Push up the filter's center tab slightly until it is released from the stopper, and remove the filter downward.
- Clean the filter. Use a vacuum cleaner to remove dust, or wash the filter with water. After washing, dry the filter completely in the shade.
- Attach the filter. Attach the filter correctly so that the "FRONT" indication is facing to the front. Make sure that the filter is completely fixed behind the stopper. If the right and left filters are not attached correctly, that may cause defects.
- Close the inlet grille.

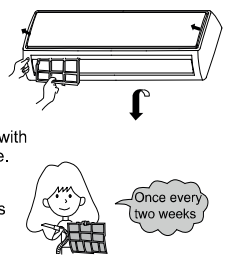

Once every two weeks

## Replacement of Air Purifying Filter

(NOTE: Air purifying filter is optional part)

- ### 1. Open the Inlet Grill

Prop up the inlet grill by using a small device named grill-support which located in the right side of the indoor unit.

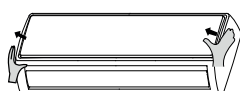
- ### 2. Detach the standard air filter

Slide the knob slightly upward to release the filter, then withdraw it.

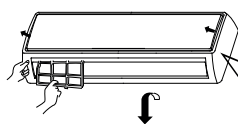

Detach old Air Purifying Filter

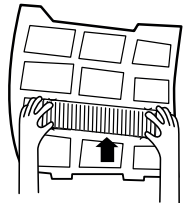

- ### 3. Attach Air Purifying Filter

Put air purifying filter appliances into the right and left filter frames.

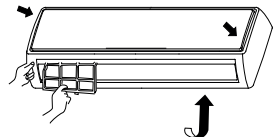

- ### 4. Attach the standard air filter

(Necessary installation)



**ATTENTION:**  
The white side of the photocatalyst air purifying filter face outside, and the black side face the unit.  
The green side of the bacteria-killing medium air purifying filter face outside, and the white side face the unit.
- ### 5. Close the Inlet Grill

Close the Grill surely

**NOTE:**

- The photocatalyst air purifying filter will be solarized in fixed time. In normal family, it will be solarized every 6 months.
- The bacteria-killing medium air purifying filter will be used for a long time, no need for replacement. But in the period of using them, you should remove the dust frequently by using vacuum cleaner or flapping them lightly, otherwise, its performance will be affected.
- Please keep the bacteria-killing medium air purifying filter in the cool and dry conditions avoid long time directly sunshine when you stop using it, or its ability of sterilization will be reduced.

# Cautions

## ⚠ WARNING

Please call Sales/Service Shop for the Installation.  
Do not attempt to install the air conditioner by yourself because improper works may cause electric shock, fire, water leakage.

## ⚠ WARNING

When abnormality such as burnt-smell found, immediately stop the operation button and contact sales shop.

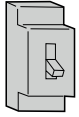

OFF



**!**  
STRICT  
ENFORCEMENT

Use an exclusive power source with a circuit breaker

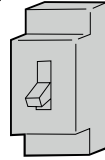

Check proper installation of the drainage securely



STRICT  
ENFORCEMENT

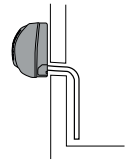

Connect power supply cord to the outlet completely



STRICT  
ENFORCEMENT

Use the proper voltage



STRICT  
ENFORCEMENT

1. Do not use power supply cord extended or connected in halfway  
2. Do not install in the place where there is any possibility of inflammable gas leakage around the unit.  
3. Do not get the unit exposed to vapor or oil steam.



PROHIBITION

Do not use power supply cord in a bundle.

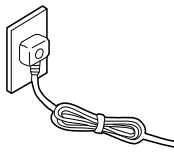

PROHIBITION

Take care not to damage the power supply cord.

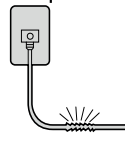

PROHIBITION

Do not insert objects into the air inlet or outlet.



PROHIBITION

Do not start or stop the operation by disconnecting the power supply cord and so on.



PROHIBITION

Do not channel the air flow directly at people, especially at infants or the aged.



PROHIBITION

Do not try to repair or reconstruct by yourself.



Connect the earth cable.

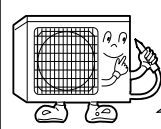

earthing

## ⚠ CAUTION

Do not use for the purpose of storage of food, art work, precise equipment, breeding, or cultivation.

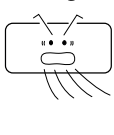

PROHIBITION

Take fresh air occasionally especially when gas appliance is running at the same time.

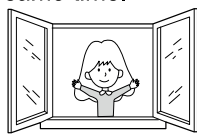

STRICT  
ENFORCEMENT

Do not operate the switch with wet hand.

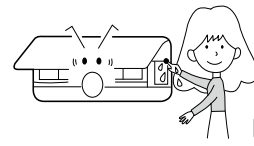

PROHIBITION

Do not install the unit near a fireplace or other heating apparatus.

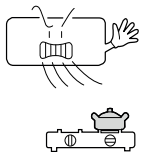

PROHIBITION

Check good condition of the installation stand

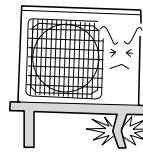

PROHIBITION

Do not pour water onto the unit for cleaning

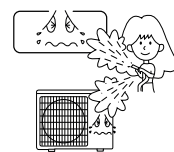

PROHIBITION

Do not place animals or plants in the direct path of the air flow

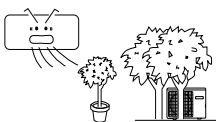

PROHIBITION

Do not place any objects on or climb on the unit.

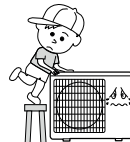

PROHIBITION

Do not place flower vase or water containers on the top of the unit.



PROHIBITION

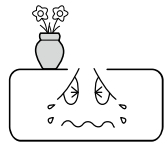

# Trouble shooting

Before asking for service, check the following first.

## Cautions

	Phenomenon	Cause or check points
Normal Performance inspection	The system does not restart immediately. 	<ul style="list-style-type: none"> <li>When unit is stopped, it won't restart immediately until 3 minutes have elapsed to protect the system.</li> <li>When the electric plug is pulled out and reinserted, the protection circuit will work for 3 minutes to protect the air conditioner.</li> </ul>
	Noise is heard 	<ul style="list-style-type: none"> <li>During unit operation or at stop, a swishing or gurgling noise may be heard. At first 2-3 minutes after unit start, this noise is more noticeable. (This noise is generated by refrigerant flowing in the system.)</li> <li>During unit operation, a cracking noise may be heard. This noise is generated by the casing expanding or shrinking because of temperature changes.</li> <li>Should there be a big noise from air flow in unit operation, air filter may be too dirty.</li> </ul>
	Smells are generated.	<ul style="list-style-type: none"> <li>This is because the system circulates smells from the interior air such as the smell of furniture, paint, cigarettes.</li> </ul>
	Mist or steam are blown out. 	<ul style="list-style-type: none"> <li>During COOL or DRY operation, indoor unit may blow out mist. This is due to the sudden cooling of indoor air.</li> </ul>
	In dry mode fan speed can't be changed.	<ul style="list-style-type: none"> <li>In DRY mode, when room temperature becomes lower than temp. setting + 2°C, unit will run intermittently at LOW speed regardless of FAN setting.</li> </ul>
Multiple check		<ul style="list-style-type: none"> <li>Is power plug inserted?</li> <li>Is there a power failure?</li> <li>Is fuse blownout?</li> </ul>
	Poor cooling 	<ul style="list-style-type: none"> <li>Is the air filter dirty? Normally it should be cleaned every 15 days.</li> <li>Are there any obstacles before inlet and outlet?</li> <li>Is temperature set correctly?</li> <li>Are there some doors or windows left open?</li> <li>Is there any direct sunlight through the window during the cooling operation? (Use curtain)</li> <li>Are there too much heat sources or too many people in the room during cooling operation?</li> </ul>

The machine is adaptive in following situation

1. Applicable ambient temperature range:

For: T1			
Cooling	Indoor	Maximum: D.B / W.B	35°C/24°C
	Outdoor	Maximum: D.B	46°C/-
Heating	Indoor	Maximum: D.B	27°C
	Outdoor	Maximum: D.B / W.B	24°C/18°C
For: T3			
Cooling	Indoor	Maximum: D.B / W.B	32°C/23°C
	Outdoor	Maximum: D.B / W.B	52°C/31°C
Heating	Indoor	Maximum: D.B	27°C
	Outdoor	Maximum: D.B / W.B	24°C/18°C

- If the supply cord is damaged, it must be replaced by the manufacturer or its service agent or a similar qualified person. The type of connecting wire is H05RN-F or H07RN-F
- If the fuse on PC board is broken please change it with a fuse type T, 3.15A/250V. If the fuse of outdoor unit on PC board is broken, please change it with the type of T, 25A/250V.
- The distance between the indoor unit and the floor should be more than 2m.
- The wiring method should be in line with the local wiring standard.
- After installation, the power plug should be easily reached..
- The used batteries should be disposed of properly.
- The appliance is not intended to use by young children or infirm persons without supervision.
- Young children should be supervised ensure that they do not play with the appliance.
- The appliance must be installed on a strong enough support.
- The wiring diagram is attached inside the machine.

T1: Application temp. range of air conditioner 18°C~43°C.

T3: Application temp. range of air conditioner -7°C~54°C.

## E-waste Guideline Manual

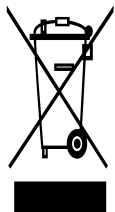

### Introduction

We at Haier in our continuous efforts of making a future better adopted eco-friendly practices and procedures. We acting towards our social, moral and statutory responsibility towards the environment and sustainable development have pledged to recycle electronic items, such as TV/LCD, refrigerator, AC etc, that are no longer useful. Haier is stepping towards leading a more conservation and optimization of resources and thereby making environment safer. We request you to donate or utilize take back scheme for your electronic good when it reaches its end-of-life, so that it can be reuse-recycle and reinvent.

"Hazard of e-waste on environment and Human Health :-

The informal method of recycling extends health hazards. Primary and secondary exposure to toxic metals, such as lead, results in diseases like Heart, Liver, Lung & Spleen Damage. Open-air burning of electronic waste, used to retrieve valuable components such as gold, not only causes damages to environment but also to human health. Incineration from burning e-waste creates fine particulate matter,

which is linked to heart and respiratory disease. However the above said is only example and the informal way to recycle causes numerous health hazards. During such informal recycling no caution or care are kept to either secure the environment or human health. The informal method of recycling extended environment hazards too. For example when different e-waste is burnt to extract metals from it, toxic chemicals are released in to the air, damaging the atmosphere. Such informal ways creates noise, water and air pollution.

"Why proper handling and management of e-waste :-

The electrical and electronic equipment (EEE) have valuable materials and hazardous/toxics substances in their components. The electronic products and electrical equipment after their useful life may not cause any harm if it is stored safely in households/stores. However, if the E-waste is opened-up and attempts are made for retrieval of useful components or material in an un-scientific manner or if the material is disposed in open, then it may cause health risks and damage to environment. E-waste can be considered as a resource that contains useful material of economic benefit for recovery of plastics, iron, glass, aluminum, copper and precious metals such as silver, gold, platinum, and palladium and lead, cadmium, mercury etc. However, at the same time presence of heavy metals (As, Cd, Hg, Pb etc.) and other toxic substances such as polychlorinated biphenyls (PCBs), etched chemicals, etc, may pose risk to health and environment during handling and recovery operations. E-waste is a problem of increasing proportions especially when crude methods are adopted for recovery of useful components from E-waste.

Thus, there is a need to encourage OUR SELF for recycling of all useful and valuable material from e-waste so as to conserve the ever depleting natural resources. Electronic component are increasingly made from recycled materials, for example for making new LCDs, more than 50% of indium is sourced by recycling used LCDs. The E-waste thus presents a scenario of urban mining for recovery of ferrous/non-ferrous/ rare earth metal and precious metal in addition to plastics and glass. However, presence of hazardous and toxic substances in the component of e-waste necessitates environmentally sound management of e-waste including collection and recycling/treatment in an environmentally sound manner.

"Management and Effect on sustainable future:-

Sustainable development as defined by Brundtland Commission is "development that meets the needs of the present without compromising the ability of future generations to meet their own needs."

The e-waste since a long time had been seen as an easy and cheapest source of metals. However due to lack of proper consideration for such source of metals as well as proper methods of recycling in India, we sent our e-waste to the improper channel/scrap vendor and thereby participated in degrading the environment. Moreover, through this improper method of extraction of metals we till date had wasted approximately 40% of the precious metals and simultaneously caused damage to our environment. If we opt the proper way to extract metals through proper channel of recycling then we can achieve approximately 90% of extraction rate of our metals as well as a better way to save our environment. However, if today while selling off our material to improper channel we will not think about our sustainable future then it is for sure that the coming generations will be facing crisis of the metals.

Customer responsibility

- consumers shall ensure that there end of life product/e-waste is channeled through collection center or dealer of authorized producer or dismantler or recycler or through the designated take back service provider of the producer to authorized dismantler or recycler;
- consumers shall ensure that such end-of-life electrical and electronic equipment are not admixed with e-waste containing radioactive material;

Electronic Waste Recycling:

Do's

- Handover/Donate/Give the discarded Electronic Equipment's only at the authorized collection centers.
- Drop the discarded Electronic Equipment's only in the bins meant for the Electronic Waste.
- Ask the retailer about the Take Back schemes.
- Consult the authorized service center as to whether the Electronic Equipment can be repaired or not, before discarding the same.
- Tell your neighbors and other persons about the hazards of improper disposal or handling or improper recycling of the Electronic Waste.
- If the unwanted Electronic Equipment still work or can be repaired then consider donating them.
- To minimize our impact on the earth and to protect the environment for future generations return your discarded Electronic Equipment's here for safe recycling

Don'ts

- Don't dump the discarded Electronic Equipment's in open or in any Land Fill Site as the same will result in contaminating the Soil and the ground water.
- Don't dispose of the discarded Electronic Equipment's in household bins or Municipal Bins.
- Don't sell or give your discarded Electronic Equipment's to any Trash Dealer or Kabadiwala/ unauthorized vendor.
- Don't try to open up the product by yourself for repair or other purposes.
- Don't mix the electronic waste into household waste stream.
- Don't keep any replaced spare part(s) from the product in exposed area. Always handover such article to service personal so that same can be recycled.

E WASTE TOXIC COMPONENT & THEIR DAMAGE TO HUMAN HEALTH

Toxic Materials	Birth Defects	Brain Damage	Heart, Liver, Lung & Spleen Damage	Kidney Damage	Nervous/ Reproductive System Damage	Skeletal System Damage
Barium	✓	✓	X	✓	✓	✓
Cadmium	X	X	X	X	X	X
Lead	X	X	✓	X	X	✓
Lithium	X	X	X	X	X	✓
Mercury	X	X	X	X	✓	✓
Nickel	X	✓	X	X	X	✓
Palladium	X	X	X	X	✓	✓
Rhodium	✓	✓	X	✓	✓	✓
Silver	X	X	X	X	X	✓

Without safe recycling, most of these toxic components will end in land fill-poisoning soil and water.