

**SAMSUNG**  
**Galaxy Watch5**  
**Galaxy Watch5 Pro**



**User manual**

# Contents

---

## Getting started

**Device Layout:** [Galaxy Watch5](#) | [Galaxy Watch5 Pro](#)

**Set up your device:** [Charge the battery](#) | [Wireless power sharing](#) | [Wear the Watch](#)

**Start using your device:** [Turn on your device](#) | [Activation](#) | [Galaxy Wearable app](#) | [Lock or unlock your device](#) | [Customize keys](#) | [Navigation](#) | [Change the watch face](#) | [Quick panel](#) | [Tiles](#) | [Notifications](#) | [Bedtime mode](#) | [Do not disturb](#) | [Theater mode](#) | [Water lock mode](#) | [Enter text](#)

## Apps

**Tools:** [Alarm](#) | [Bixby](#) | [Calculator](#) | [Calendar](#) | [Compass](#) | [Contacts](#) | [Find My Phone](#) | [Reminder](#) | [Samsung Global Goals](#) | [Samsung Pay](#) | [Stopwatch](#) | [Timer](#) | [Voice Recorder](#) | [Weather](#) | [World clock](#)

**Media:** [Buds controller](#) | [Gallery](#) | [Media controller](#) | [Messages](#) | [Phone](#)

**Health:** [Samsung Health](#) | [Samsung Health Monitor](#)

**Google:** [Play store](#) | [Maps](#)

**Microsoft:** [Outlook](#)

## Settings

**Connections:** [Bluetooth](#) | [Wi-Fi](#) | [NFC](#) | [Disconnection alerts](#) | [Airplane mode](#) | [Mobile networks](#) | [Data usage](#)

**Notifications:** [Notification settings](#) | [Advanced notification settings](#) | [Wireless emergency alerts](#)

**Sounds and vibration:** [Sound mode](#) | [Vibration](#) | [Call vibration](#) | [Notification vibration](#) | [Volume](#) | [Ringtone](#) | [Notification sound](#) | [System vibration](#) | [System sounds](#)

**Display:** [Adjust screen brightness](#) | [Always on Display](#) | [Screen wake-up](#) | [Show media controls](#) | [Set the screen timeout](#) | [Show last app](#) | [Font](#) | [Touch sensitivity](#) | [Show charging info](#)

**Device maintenance:** [Battery](#) | [Power saving mode](#) | [Watch only mode](#) | [Text to speech](#) | [Date and time](#) | [Orientation](#) | [Connect to a new phone](#) | [Reset the Watch](#) | [Location](#)

**Accessibility:** [TalkBack](#) | [Visibility enhancements](#) | [Hearing enhancements](#) | [Interaction and dexterity](#) | [Accessibility](#) | [Installed services](#)

**Security and privacy:** [Set a screen lock](#) | [Permission manager](#)

**Accounts:** [Samsung account](#) | [Google account](#)

**Other:** [Software update](#) | [Tips and tutorials](#) | [About watch](#)

## Learn More

[Videos](#) | [Tips](#) | [Samsung Care](#) | [Talk to an agent](#)

## Legal information

[Restricting children's access to your mobile device](#)

# Getting started

---

Galaxy Watch5

Galaxy Watch5 Pro

Set up your device

Start using your device

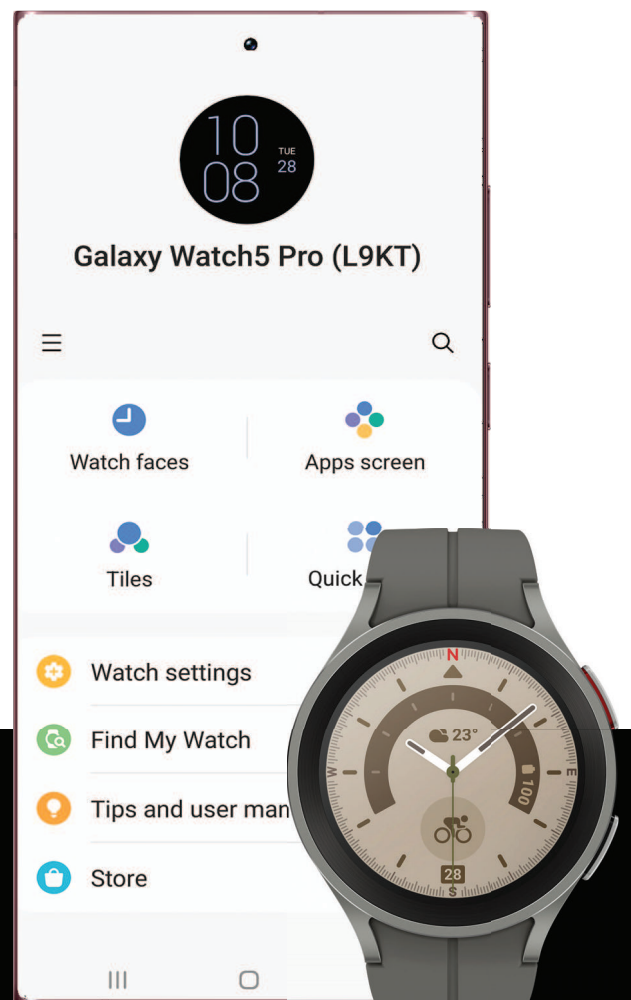

# Galaxy Watch5



# Galaxy Watch5 Pro



# Set up your device

Learn more about your device hardware, assembling and charging, and how to get started using your new device.

[Charge the battery](#) | [Wireless power sharing](#) | [Wear the Watch](#)

## Charge the battery

Your device is powered by a rechargeable battery.

Watch5 Pro  
D-Buckle Sport Band

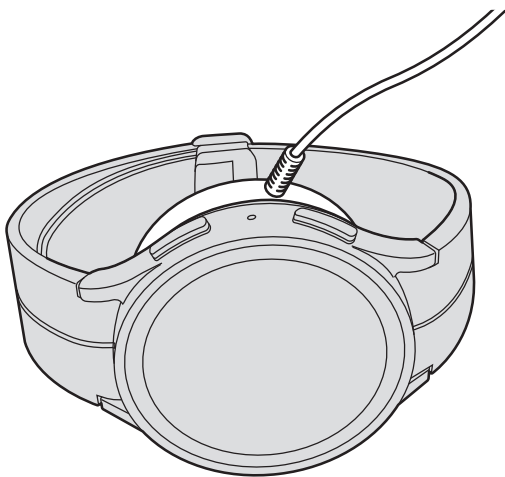

Watch5

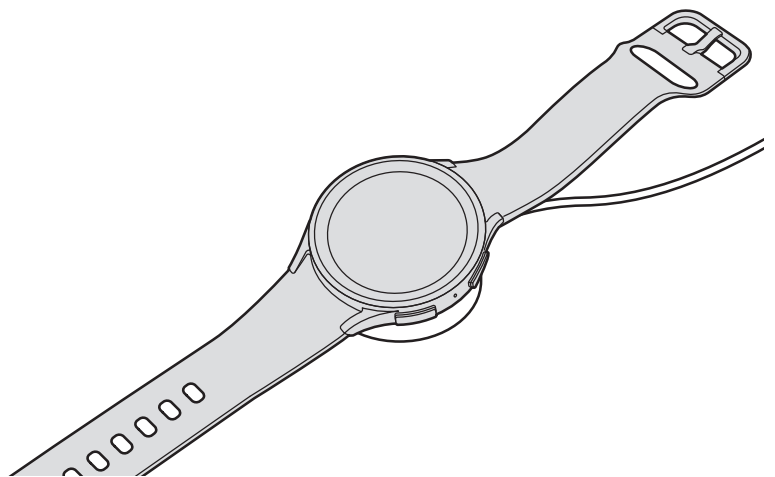

1. Connect the wireless charger to a charging port.
2. Place the watch onto the wireless charger, aligning the center of your watch with the center of the wireless charger.
3. After fully charging, disconnect the watch from the wireless charger.

 **CAUTION** The charging head for plugging the USB cable into a wall outlet is not included. Use only Samsung charging devices rated with an output voltage of 5v and an output current of over 150mA (sold separately). Samsung accessories are designed for your device to maximize battery life. Using other accessories may void your warranty and may cause damage.

 **NOTE** Prevent the USB charger port and the small end of the charger cable from coming into contact with conductive materials, such as liquids, dust, metal powders, and pencil leads.

While charging, the device and the charger may become hot. This does not affect the device's lifespan or performance and is in the device's normal range of operation.

Remove the device from the charger and wait for the device to cool down. For more information, visit <https://www.samsung.com/us/support/answer/ANS00076952>.

 **NOTE** Do not disassemble, modify, or repair your device. Placing objects, such as magnetic stripe cards, including credit cards, phone cards, passbooks, and boarding passes, next to the device or charger may cause damage from the charger or device's magnetic field.



## Wireless power sharing

Wirelessly charge your device using a supported Samsung smartphone. Some features are not available while sharing power.



1. From your phone, enable the Wireless power sharing feature.
2. With the phone face down, place the compatible device on the back of the phone to charge. A notification sound or vibration occurs when charging begins.



**NOTE** Wireless power sharing works with most Qi-Certified devices. Requires minimum 30% battery to share. Speed and power efficiency of charge varies by device. May not work with some accessories, covers, or other manufacturer's devices. If you have trouble connecting or charging is slow, remove any cover from each device.

For best results when using Wireless power sharing, please note:

- Remove any accessories or cover before using the feature. Depending on the type of accessory or cover, Wireless power sharing may not work properly.
- The location of the wireless charging coil may vary by device, so you may need to adjust the placement to make a connection. When charging starts, a notification or vibration will occur, so the notification will help you know you've made a connection. During charging, do not move or use either device.
- Call reception or data services may be affected, depending on your network environment.
- Charging speed or efficiency can vary depending on device condition or surrounding environment.
- Do not use headphones.

## Wear the Watch

Wrap the watch firmly around your lower arm just above your wrist as shown below. Do not fasten the watch too tightly.



**WARNING** Wear the device correctly. If you feel discomfort while using the device, stop using it. If your device becomes hot, please remove it until it cools.



1. Open the buckle and place the strap around your wrist.
2. Fit the strap to your wrist, insert the pin into an adjustment hole, and then secure the buckle to close it.

## Adjust the D-Buckle Sport Band

The D-Buckle Sport Band can be adjusted for the perfect fit (Watch5 Pro only).

1. Open the magnetic buckle.

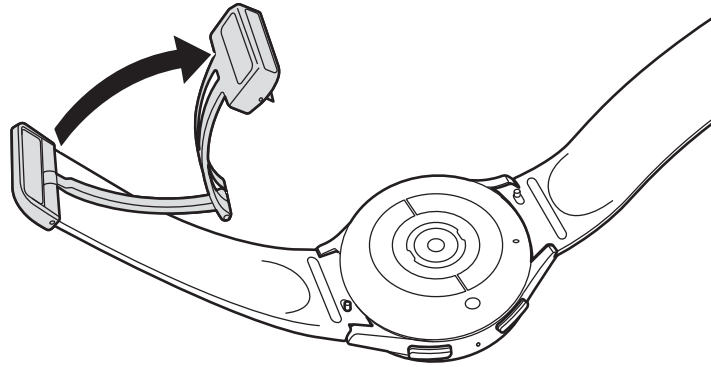

2. Open the clasp and slide the end of the band to adjust the length.

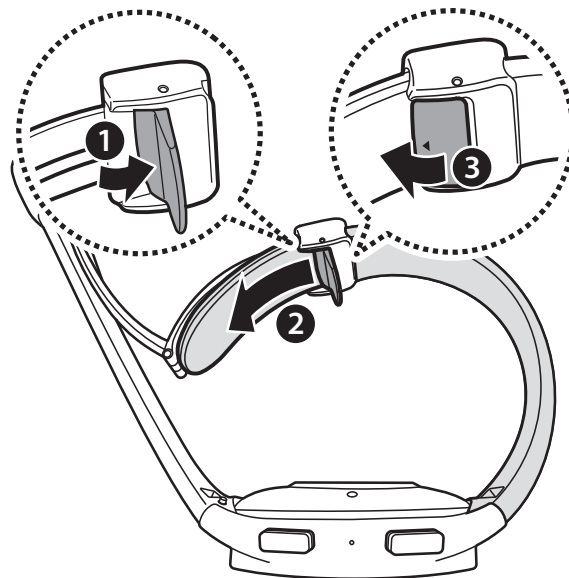

## Strap tips and precautions

- Some people may experience discomfort when wearing the watch for prolonged periods.
- If you have sensitive skin or fasten the watch too tightly, you may feel some discomfort.

- Do not expose the straps to very wet conditions. Wet straps can cause skin irritations. Dry the straps first. If you experience skin irritation when wearing the watch, stop wearing it and consult a physician.

## Replace the strap

Detach the strap from the watch to replace it with a new one.

To remove the strap:

- Slide the strap's spring bar inward and pull the strap away from the watch.

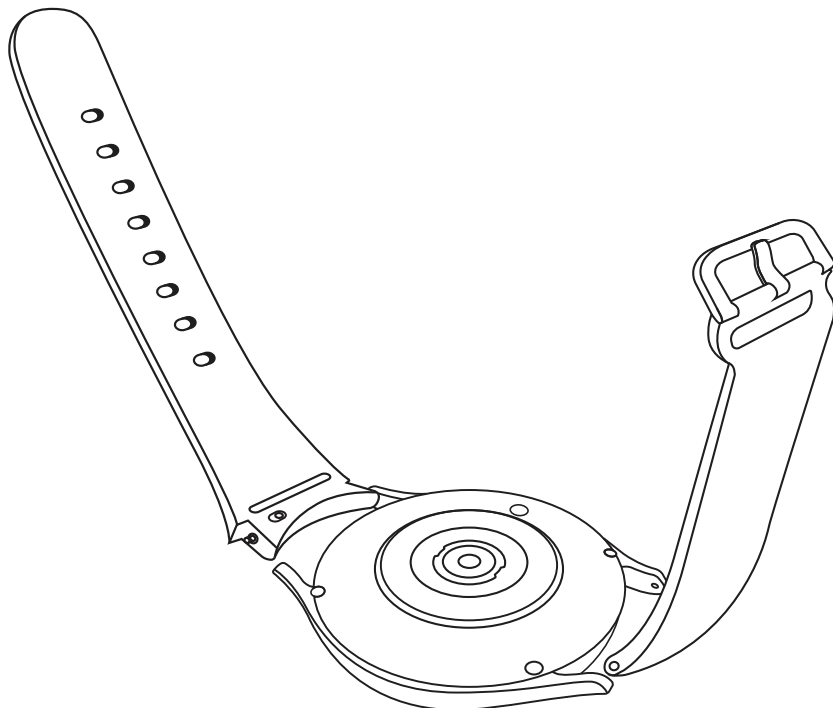

To replace the strap:

1. Insert one end of the spring bar into the hole on the side of the watch.
2. Slide the other spring bar inward, and release it once the strap is in place.

# Start using your device

[Turn on your device](#) | [Activation](#) | [Galaxy Wearable app](#) | [Lock or unlock your device](#) | [Customize keys](#) | [Navigation](#) | [Change the watch face](#) | [Quick panel](#) | [Tiles](#) | [Notifications](#) | [Bedtime mode](#) | [Do not disturb](#) | [Theater mode](#) | [Water lock mode](#) | [Enter text](#)

## Turn on your device

Use the Home key to turn your watch on or off.

- Press and hold the **Home** key.
  - To turn the watch off, swipe down from the top of the watch screen to open the Quick panel, and tap  > **Turn off**.



**TIP** To restart the watch, press and hold the **Home** and **Back** keys for more than seven seconds.

## Activation

The Galaxy Watch5 and Watch5 Pro are 4G LTE-enabled. Get texts, alerts, make and receive calls, even when you leave your phone behind.

To manage your watch's mobile plan:

- From the smartphone, tap  **Galaxy wearable**, tap  **Watch settings** > **Mobile plans**. Consult your service provider for more information about activation.

## Galaxy Wearable app

To connect your watch to a smartphone, install the Galaxy Wearable app on the smartphone. You can download the app from the Galaxy Store or the Google Play™ store.

Galaxy Wearable is compatible with select devices using Android 8.0 and later with at least 1.5 GB RAM. Supported devices may vary by carrier and device. Some features may not be available. For best results, connect with compatible Samsung Galaxy devices. Visit [samsung.com/us/support/owners/app/galaxy-wearable-watch](https://samsung.com/us/support/owners/app/galaxy-wearable-watch) for a list of compatible smartphones.

## Connect the watch to a smartphone

Turn on the watch before connecting to your phone.

1. From the smartphone, tap  **Galaxy Wearable**. If necessary, update the app to the latest version.
2. Tap **Start** and select your device.
3. When the Bluetooth® pairing request window is displayed, confirm the passkeys displayed on your watch and smartphone match, and then tap **Confirm**.
4. Follow the prompts to complete the connection.

When the devices are connected, a tutorial is displayed on the watch's screen. Follow the prompts to learn the basic controls.

## Back up data

The watch can only be connected to one smartphone at a time. When you connect the watch to a new smartphone, the watch automatically resets and all data is removed from its memory. Make sure you back up any important data stored on your watch.

1. From the smartphone, tap  **Galaxy Wearable**, tap  **Watch settings**.
2. Tap  **Account and backup** to customize your backup settings.

## Remote connection

Set the watch to remotely connect to the smartphone when a Bluetooth connection between the devices is not available. With this connection, you can still receive notifications from your smartphone.

1. From the smartphone, tap  **Galaxy Wearable**, tap  **Watch settings**.
2. Tap  **Advanced features** > **Remote connection** to enable the feature.

## Disconnect

To disconnect the watch from your phone:

1. From the smartphone, tap  **Galaxy Wearable**, tap  **Menu**.
2. Tap  **Disconnect** by the name of your watch.

## Lock or unlock your device

By default your screen is not locked. You can use the screen lock feature to secure your device. See [Set a screen lock](#).

When enabled, your watch locks when you remove it from your wrist or when the screen times out while you are wearing it.

To lock the watch:

- Cover the screen with your palm.

To unlock the watch:



- Press any key to turn on the watch screen.
  - If you have a lock screen enabled, press any key to enter your pattern or pin and unlock the watch.

## Customize keys

You can customize the shortcuts assigned to the Home and Back keys.



### Home key

Configure shortcuts for the Home key.

1. From  **Settings**, tap  **Advanced features** > **Customize keys**.
2. Tap an option under **Home key** to choose a shortcut.
  - **Double press**: Choose which feature is launched when the Home key is pressed twice. By default this option is set to open Samsung Pay.
  - **Press and hold**: Choose which feature is launched when you press and hold the Home key. By default this option is set to wake Bixby.



### Back key

Configure shortcuts for the Back key.

1. From  **Settings**, tap  **Advanced features** > **Customize keys**.
2. Tap **Short press** and choose a shortcut option. By default this option is set to go to the previous screen.



## Gestures

1. From  **Settings**, tap  **Advanced features**.
2. Tap an option under **Gestures** to enable it.
  - **Answer calls:** Shake your arm twice, bending at the elbow, to answer calls.
  - **Dismiss alerts and calls:** Rotate your wrist twice to dismiss alarms or decline incoming calls.
  - **Quick launch:** Select an app or feature to quick launch.

## Navigation

The touchscreen responds best to a light touch from the pad of your finger. Using excessive force or a metallic object on the touchscreen may damage the tempered glass surface and void the warranty.

### Tap

Lightly tap the screen to launch an app or select a menu item.



## Swipe

Lightly drag your finger vertically or horizontally across the screen to view panels.



## Drag

Touch and hold an item, and then move it to a new location.



## Change the watch face

The first screen when you turn on the Galaxy Watch5 and Watch5 Pro is the watch face. You can choose a watch face with different colors, styles, and information displayed.

From your phone:

1. From the smartphone, tap  **Galaxy Wearable** > **Watch faces**.
2. Tap a watch face to select it.

From your watch:

1. Touch and hold the watch face.
2. Swipe left and tap **Edit on phone** or swipe right and tap **Add watch face**.
3. Tap **Customize** to select a background color and items to display on the watch face.

## Quick panel

Instead of navigating through the Settings menu, you can access commonly used settings through the Quick panel, where you can also view the Status bar.







- Swipe down from the top of the watch screen to open the Quick panel.
  - Tap a quick setting icon to turn it on or off.
  - Touch and hold a quick setting icon to open the setting.



## Status bar



Indicator icons display at the top of the screen in the Status bar. Swipe down from the top of the watch screen to view the Status bar.

### Indicator icons

	Battery full
	Bluetooth connected
	Bluetooth enabled, but not connected
	Wi-Fi connected
	Airplane mode
	LTE network connected (LTE model only)
	Signal strength (LTE model only)

## Tiles

Tiles are shortcuts to apps and features that you can add as a screen on your watch.

- From the watch face, swipe left to view tiles.
  - To add tiles, swipe to the end of the tiles screens, and tap  **Add tiles**.
  - To move tiles, touch and hold a tile, and then drag it to the desired location.
  - To delete tiles, touch and hold a tile, and then tap  **Remove**.

## Manage tiles from your phone

- From the smartphone, tap  **Galaxy Wearable**, tap **Tiles**.
  - Drag to reorder tiles.
  - Tap  **Add** to add the tile.
  - Tap  **Remove** to delete tiles.

## Notifications

Stay up to date with events, notifications, and messages from your smartphone. When you receive a notification, information about the notification, such as its type, is displayed on the screen while the watch is vibrating.

- From the watch screen, swipe right and tap a notification to view details.



## Bedtime mode

Bedtime mode mutes all alerts, except for alarms and notifications. This keeps the screen off and mutes most sounds while you sleep.



- From the Quick settings panel, tap  to put the watch in Bedtime mode.

 **TIP** You can also access Bedtime mode from the Settings menu. From  **Settings**, tap  **Advanced features** > **Bedtime mode**. Here you can schedule bedtime mode.

## Do not disturb

Use these options to determine block out time where notifications are turned off, and during which time periods you want to enter this mode.

- From the Quick settings panel, tap  to put the watch in Do not disturb mode.

 **TIP** You can also access Do not disturb from the Settings menu. From  **Settings**, tap  **Notifications** > **Do not disturb**.

## Theater mode

Theater mode keeps the screen turned off and silences all sounds.





- From the Quick settings panel, tap  to put the watch in Theater mode.



## Water lock mode

You can use Water lock mode to exercise in the water while wearing your watch. While in Water lock mode, touchscreen, wake-up gestures, and watch always on will be disabled.

- From the Quick settings panel, tap  to put the watch in Water lock mode.

 **TIP** You can also enable Water lock mode from the Setting menu. From  **Settings**, tap  **Advanced features** > **Water lock**. Tap  to enable.

## Exit water lock mode

1. Press and hold the **Home** key for two seconds to turn off the mode. The watch will make sounds to eject water from the speaker.
2. Press the **Home** key to stop the sound.
3. Shake the watch to remove any water from the pressure sensor.

## Enter text

Text can be entered by speaking, drawing, or by using a keyboard.







## Default keyboard

Select a default keyboard type for text input.

- From  **Settings**, tap  **General** > **Input** > **Keyboard list and default** and select your default keyboard.



## Choose a keyboard

When you need to enter text from your watch, you can choose which keyboard you prefer.



- Tap an option for text input:
  - Tap  **Voice input** and speak the message you want to enter.
  - Tap  **Write**, and then use your finger to draw letters.
  - Tap  **Emoji** to add emojis to your message.
  - Tap  **Samsung Keyboard** to use the QWERTY keyboard.
  - Tap  **Numbers and symbols** to use add numbers or symbols to your message.

## Keyboard settings

Change the Samsung keyboard settings.

- From  **Settings**, tap  **General** > **Input** > **Samsung keyboard**, and tap options to customize:
  - **Input languages:** Select languages for text input.
  - **Smart typing:** Customize features like predictive text, auto capitalize, and more.
  - **Swipe, touch, and feedback:** Set the watch to vibrate or play sounds when you tap a key on the keyboard or enable swipe controls.
  - **Keyboard data:** Return your keyboard to the default settings and remove word predictions and personalized data.

## Quick responses

- From  **Settings**, tap  **General** > **Input** > **Quick responses** to customize:
  - **Message suggestions:** Get suggested text when you create or reply to a message.
  - **Custom responses:** Customize your responses on your phone.

# Apps

---

Navigate the apps screen

Tools

Media

Health

Google

Microsoft

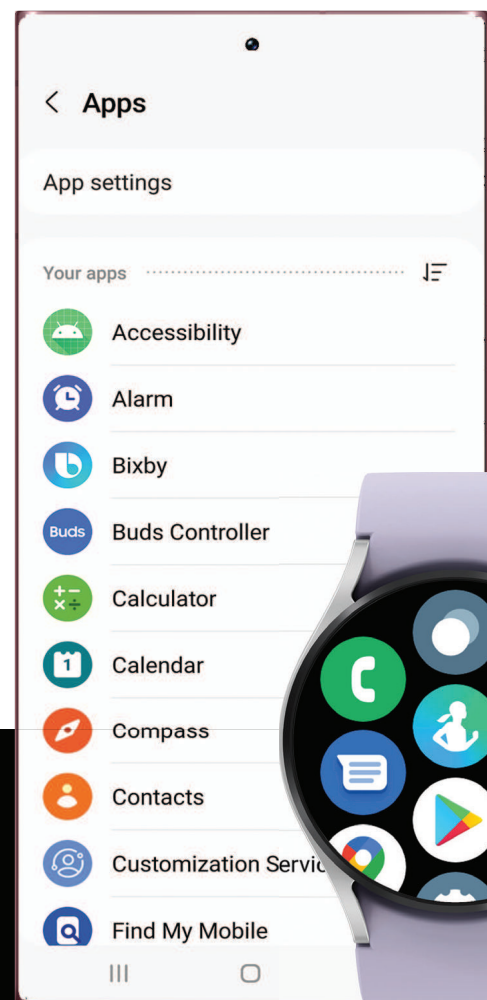

# Navigate the apps screen

## Uninstall apps | Apps Settings

The Apps list displays all preloaded and downloaded apps. Apps can be downloaded from the Google Play store.

- From the watch screen, swipe up from the bottom of the screen to open the Apps screen.
  - To scroll through the list of apps, swipe up and down.
  - To view recently opened apps, tap  **Recent apps**.

## Uninstall apps

Uninstall apps you have download.

1. From Apps on your watch, touch and hold an app.
2. Tap  **Uninstall**. This option is not available for all apps.

## Apps Settings

Customize how apps are displayed on the Apps screen.

### Default apps

Choose which apps to use for making calls, sending messages, and more.

- From  **Settings**, tap  **Apps** > **Choose default apps**, and choose an option for each category.

### Health Platform

Choose which Health platform to use.

- From  **Settings**, tap  **Apps** > **Health platform**, and choose an app.

## App permissions

Configure permissions for each installed app.

1. From Apps, tap  **Settings**.
2. Tap  **Apps > Permissions**.
3. Tap each feature to enable or disable permission to access or use the feature.

# Tools

The following apps are useful tools that come pre-installed or downloaded over-the-air to your device.

[Alarm](#) | [Bixby](#) | [Calculator](#) | [Calendar](#) | [Compass](#) | [Contacts](#) | [Find My Phone](#) | [Reminder](#) | [Samsung Global Goals](#) | [Samsung Pay](#) | [Stopwatch](#) | [Timer](#) | [Voice Recorder](#) | [Weather](#) | [World clock](#)

## Alarm

Set an alarm to ring at a specific time.

### Create an alarm

Create an alarm event. You can set one-time or recurring alarms.

1. From Apps, tap  **Alarm**.
2. Tap **Add on watch** and enter the time.
3. Tap **Next**, and select the days to repeat the alarm.
4. Tap **Save** when finished.





**NOTE** You can also view alarms saved on your phone. To add an alarm on your phone, tap **Add on phone**.

### Stop or snooze an alarm

- Tap  **Cancel** to stop an alarm or tap  **Snooze** to snooze.

### Delete an alarm

You can disable alarms or delete them.

- From  **Alarm** view the list of alarms on your watch and phone.
  - To disable the alarm, tap .
  - To delete the alarm, touch and hold the alarm and tap **Delete**.

## Bixby

Bixby is a voice service that helps you use your watch more conveniently. You can talk to Bixby to launch a function or provide you with information. To use Bixby, your mobile device must be connected to a Wi-Fi or mobile network, and you must sign in to your Samsung account.

1. From Apps, tap  Bixby.
2. Follow the prompts to set up Bixby.

 **TIP** You can also press and hold the **Home** key to access Bixby. For more information, see [Customize keys](#).



## Calculator

The Calculator app features basic math functions.

- From Apps, tap  **Calculator**, and enter the math equation.

## Calendar

View events scheduled on the smartphone.

1. From Apps, tap  **Calendar**.
2. Swipe up or down to view a list of upcoming events.
  - Tap  for month view.
  - Tap  for week view.
  - Tap **Show on phone** to edit and add events.

## Compass

View and use your watch as a compass. The first time you use the Compass app the watch will guide you on how to calibrate your watch.

- From Apps, tap  **Compass**.





## Contacts

View your smartphone's contact list on your watch.



### Find a contact

You can search for a contact or scroll through the list to find one by name.

- From  **Contacts**, tap  **Search**, and then enter characters to find contacts that match.



### Call or message a contact

You can send a message or make a phone call from Contacts.

- From  **Contacts**, tap the contact you want to connect with, and tap an option:
  -  **Call**: Begin a phone call with the contact.
  -  **Message**: Type a message to the contact.



## Find My Phone

If you misplace your smartphone, your watch can help you find it.

1. From Apps, tap  **Find My Phone**.
2. Tap **Start**.
  - The Phone vibrates and the screen turns on.
3. Drag  **Dismiss** on your smartphone or tap **Stop** on the watch.

### Find your Watch

You can also locate your watch by making it light up and make sounds from the Galaxy Wearable app.



1. From  **Galaxy Wearable**, tap  **Find My Watch**.
2. Tap **Start**.
3. Tap **Stop** on the smartphone or drag  on the watch.

## Reminder

Add reminders for events and set alarms outside of the Calendar app.

### Create a reminder

Set up and track reminders on your watch:

1. From Apps, tap  **Reminder**.
2. Tap  **Write**, and then enter the reminder information.
3. Tap **Set time**, set the time for your reminder, and then tap **Next**.
4. Set the date and repeat options, then tap **Done**.
5. Tap **Save** when finished.

### Complete a reminder

To mark reminders as complete:

- From  **Reminder**, tap the **checkbox** beside a reminder to set it as complete.
  - To view completed reminders, tap **Completed**.

## Samsung Global Goals

Learn more about the Global Goals initiative and contribute towards donations that support these causes with ads from this app.

## Samsung Pay

Pay almost anywhere that accepts a debit, credit, or gift card. Samsung Pay supports Near Field Communication (NFC) to allow quick and secure payment through standard credit card readers. For more information, see [samsung.com/us/samsung-pay](https://samsung.com/us/samsung-pay).

### Set up Samsung Pay

1. From Apps, tap  **Samsung Pay**.
2. Follow the prompts to complete the setup.

## Make a payment

1. From any screen, press and hold the **Back** key to launch  **Samsung Pay**.
2. Swipe to select a card.
3. Hold the watch near an NFC reader to pay.



**NOTE** You can use Samsung Pay for up to 5 transactions without the smartphone. This may vary depending on the bank/institution issuing the account.



## Stopwatch

The Stopwatch lets you time events down to a hundredth of a second.

1. From Apps, tap  **Stopwatch**.
2. Tap **Start** to begin timing.
  - To keep track of lap times, tap **Lap**.
3. Tap **Stop** to end timing.
  - To continue timing after stopping the clock, tap **Resume**.
  - To reset the Stopwatch to zero, tap **Reset**.





## Timer

Set a countdown timer for up to 59 hours, 59 minutes, and 59 seconds.

### Set a timer

Create an alarm event. You can set one-time or recurring alarms.







1. From Apps, tap  **Timer**.
2. Tap a time or  **Custom** to set the Timer.
3. Tap  **Start**.

### Stop the timer

- Drag  **Cancel** or  **Restart** when the timer goes off.

## Voice Recorder

Use your voice to record memos.

1. From Apps, tap  **Voice Recorder**.
2. Tap  **Record** and begin recording your message.
  - To convert your speech to text, tap  **Speech-to-text** before recording.
  - To pause the recording, tap  **Pause**.
3. Tap  **Stop** when you are finished.
  - You can access your voice recordings, from  **Recordings**.

## Weather

View weather information on the watch for locations set on the smartphone.

1. From Apps, tap  **Weather**, tap **Add** and follow the prompts.
2. Swipe through the screens to view the weather information.
3. To add a city, tap the location, and tap **Manage on phone**.

## World clock

Keep track of the current time in multiple cities around the globe.

1. From Apps, tap  **World clock**.
2. Tap a city to view the time and temperature at that location.
  - To add a city to the World clock, tap **Add on phone**.

# Media

The following media apps come pre-installed or downloaded over-the-air to your device.

[Buds controller](#) | [Gallery](#) | [Media controller](#) | [Messages](#) | [Phone](#)



## Buds controller

Control your earbuds with your watch. Connect your earbuds directly to your watch or to the Galaxy Wearable app on your phone.

1. From Apps, tap  **Buds controller**.
2. Follow the instructions to connect your earbuds.

## Gallery

View and manage images.



1. From Apps, tap  **Gallery**.
2. Swipe through the image list and then tap an image to view it.
  - To zoom in or out, double tap the image.
  - To delete an image, touch and hold the image, and then tap  **Delete**.

## Import and export images



Images can be exchanged between your watch and smartphone.

### Import images from your smartphone

Send images or entire albums from your smartphone to your watch.



1. From the smartphone, tap  **Galaxy Wearable**, tap  **Watch settings**.
2. Tap **Manage content** > **Add images**.
3. Select files or albums and tap **Done**.

To automatically sync images on your smartphone with your watch:

1. From the smartphone, tap  **Galaxy Wearable**, tap  **Watch settings**.
2. Tap **Manage content** > **Auto sync** to enable. Images will be synced while the watch battery power is at least 15 percent.
  - **Image limit:** Set a limit to the number of images that can be synced to your watch.
  - **Albums to sync:** Select which Gallery albums to sync to your watch.

## Export images to your phone

Send images from your watch to your phone.

1. From  **Gallery**, touch and hold an image.
2. Tap  **Copy to phone**.

## Take a screenshot

Capture an image of your screen. It is automatically saved to the Gallery app.

- From any screen, press the **Home** and **Back** keys at the same time.

## Media controller

You can use the Media controller to connect to a computer, phone, or tablet using Bluetooth and control media with your watch.

To connect:

1. From Apps, tap  **Media Controller**.
2. Tap a device in the list to connect your watch.
3. Use the media controls on your watch.





## Import music

Import music saved on your smartphone to your watch.

1. From the smartphone, tap  **Galaxy Wearable**, tap  **Watch settings**.
2. Tap **Manage content > Add tracks**.
3. Select files and tap **Done**.

To sync recently added music on your smartphone with your watch:

1. From the smartphone, tap  **Galaxy Wearable**, tap  **Watch settings**.
2. Tap **Manage content > Auto sync**, music will be synced while the watch's battery power is at least fifteen percent.



## Messages

View messages and reply to or call the sender using the watch.

### View and Send messages



You may incur additional charges for receiving messages while you are roaming.

- From the notifications screen, tap message to view it.



## Send messages

Create and send messages from your watch.

1. From Apps, tap  **Messages** >  **Compose**.
2. Tap **Enter recipient** to enter a phone number, or  **Contacts** to add a number you have saved.
3. Choose a keyboard to compose your message.
4. Tap **Send**.

## Delete messages

Delete messages from your watch.

- From  **Messages**, touch and hold a conversation to select it, and tap **Delete**.

## SOS messages

Send a message with your location to designated contacts when you are in an emergency situation.

1. From  **Galaxy Wearable**, tap **Watch settings** > **Safety and emergency** > **SOS with Home key**.
2. Tap options for when to send SOS messages to enable them:
  - **SOS with Home key**: To choose the number of times to press the Home key to send an SOS message, tap either **3 times** or **4 times**.
  - **Hard fall detection**: Automatically send SOS messages when a hard fall is detected.
3. Tap an option to select the emergency contacts that you want to receive your SOS.
  - **Medical info**: Emergency responders and others can access this info even when your phone is locked.
  - **Send messages to**: Tap the contacts you want to receive your SOS messages.
  - **Make SOS call to**: Tap the contacts you want to receive your SOS calls.

To send SOS messages:

- Press the **Home** key quickly three times to send an SOS message.

# Phone

Make and answer calls on your phone from your watch.



## Make a call

Make a call from your watch.

1. From Apps, tap  **Phone**.
2. Tap  **Keypad** and enter a number or tap  **Contacts** and select a contact to call.
3. Tap  **Call**.

## Answer a call

Answer incoming calls.

- On the incoming call screen, drag  **Answer** to answer the call on your phone.

## Reject a call

Reject incoming calls.

- Drag  **Decline** to reject a call and send it to your voicemail.

## End a call

End a call from your watch.

- Tap  **End** when you are ready to end your call.



## Phone settings

Configure settings for the Phone app. Options may vary by carrier.

- From Apps, tap  **Phone** > **Settings** and tap an option to customize:
  - **Block numbers:** View the list of blocked numbers, and choose to block unknown callers.
  - **Preferred number:** Choose your phone or watch phone number as default. This option is only available on LTE devices with a mobile plan.
  - **Voicemail:** Listen and edit your voicemail message.
  - **Supplementary services:** Configure any supplementary service settings.

## Gestures

Use gestures as shortcuts on the watch.

- From  **Settings**, tap  **Advanced features**, and tap an option under **Gestures**:
  - **Answer calls**: Shake your arm twice bending at the elbow to answer incoming calls.
  - **Dismiss alerts and calls**: Rotate your wrist twice to dismiss alarms or decline incoming calls.
  - **Quick launch**: To quick launch within the first 5 seconds after the screen turns on, make a fist and bend your wrist down and then up again twice.

# Health

The following health apps come pre-installed or downloaded over-the-air to your device.

[Samsung Health](#) | [Samsung Health Monitor](#)



## Samsung Health

Samsung Health helps you manage your wellness and fitness. Set fitness goals and regularly record and check your progress.

When the watch is synced with the Samsung Health app, you can save and manage health-related data and receive useful information about your health every day.

Only your most recent activity records are stored on your watch. You can view previous data on the smartphone where the Samsung Health app is installed.

- From the Apps screen, tap  **Samsung Health**.



**CAUTION** The information gathered from this device, Samsung Health, or related software is not intended for use in the diagnosis of disease or other conditions, or in the cure, mitigation, treatment or prevention of disease.

The accuracy of the information and data provided by this device and its related software, including heart rate readings, may be affected by factors such as environmental conditions, skin condition, specific activity performed while using/wearing the device, settings of the device, user configuration/user-provided information, placement of the sensor on the body, and other end-user interactions. For more information on proper wear and use, visit [samsung.com/us/heartratesensor](https://samsung.com/us/heartratesensor).

## Before you start exercising

Although the Samsung Health application is a great companion to your exercise routine, it is always best to make sure you consult with your physician before beginning any exercise regimen. While moderate physical activity, such as brisk walking, is safe for most people, health experts suggest that you talk with your doctor before you start an exercise program, particularly if you have any of the following conditions:

- Heart disease; Asthma or lung disease; Diabetes, or liver or kidney disease; and Arthritis.

Before beginning your exercise regimen check with your doctor if you have symptoms suggestive of heart, lung, or other serious disease, such as:

- Pain or discomfort in your chest, neck, jaw, or arms during physical activity;
- Dizziness or loss of consciousness;
- Shortness of breath with mild exertion or at rest, or when lying down or going to bed;
- Ankle swelling, especially at night;
- A heart murmur or a rapid or pronounced heartbeat;
- Muscle pain when walking upstairs or up a hill that goes away when you rest.

It is recommended that before engaging in an exercise routine, you consult with your doctor or medical practitioner. If you are unsure of your health status, have several health problems, or are pregnant, you should speak with your doctor before starting a new exercise program.

## Daily activity

View a summary of your daily activity broken down by your step count, active time, and active calories.

- From  **Samsung Health**, tap **Daily activity** and swipe down to view a graph of your activity.

## Steps

Your watch counts your number of steps, measures the distance traveled, calories burned, and floors climbed.

- From  **Samsung Health**, tap **Steps** to view a graph of your step count records.

To set your steps target:

1. From  **Samsung Health**, tap **Steps**.
2. Swipe to the bottom of the screen, and tap **Set target**.
3. Set your target step count, and tap **Done**.

## Exercise

Record your exercise information using Samsung Health's exercise feature.

When your watch and smartphone are connected, this feature uses your smartphone's location information.

### Exercise with the watch

1. From  **Samsung Health**, tap **Exercise**.
2. Tap **Choose workout** and swipe to an activity type.
3. Tap the activity to start monitoring your exercise. Your heart rate measurement will be displayed after you begin your exercise.
4. Press and hold the **Back** key to pause the workout.
  - Swipe right to view the exercise controls.
  - Press the **Resume** to resume the workout.
  - Tap **Finish** to complete your workout and view your workout summary.
5. Swipe to and tap **View log** to see your workout log.





**TIP** You can also press and hold the **Back** key to quickly access the Exercise list and begin working out. For more information, see [Customize keys](#).

## Sleep

Automatically track your sleep patterns.

1. From  **Samsung Health**, tap **Sleep**.
2. Swipe up to view your sleep data.

## Body composition

Keep track of your Body composition.

1. From  **Samsung Health**, tap **Body composition**.
2. Tap **Measure** and enter your information.
3. Follow the prompts to measure your body composition.
  - After a moment, your body composition is displayed on the screen.

## Women's health

Record and track your menstrual cycle.

- From  **Samsung Health**, tap **Women's health**.
  - Tap **Enter period** to record your menstrual cycle.
  - Swipe up on the screen to view your ovulation and predicted period information.
  - Tap **Add log** to record your symptoms.

## Heart rate

Measure and record your heart rate. Take heart rate measurements when you are seated and relaxed.

## Stress

Keep track of your stress. Breathing exercises are also available to help reduce stress.

1. From  **Samsung Health**, tap **Stress**.
2. Tap **Measure** and follow the prompts to measure your current stress level.
  - After a moment, your stress level is displayed on the screen.

## Breathing exercise

Use the Breathe feature to help reduce stress by doing a breathing exercise.

1. From  **Samsung Health**, tap **Stress**.
2. Follow the prompts and swipe up to see the Breathe feature, and adjust the number of breathing cycles.
3. Tap **Start** to begin.

## Blood oxygen

View your blood oxygen levels through the Samsung Health app.

1. From  **Samsung Health**, tap **Blood oxygen**, and tap **Measure** to begin.
2. Follow the prompts to position the device and your arm properly.
3. Tap **OK** to start measuring blood oxygen.

## Weight management

View your progress in reaching your target weight. Weight management needs to be enabled and a target weight set through the Samsung Health app on your phone.

1. From  **Samsung Health**, tap **Weight management**.
2. Swipe up on the screen to see your calorie intake and weight status records.
3. Tap **Info** for more detailed descriptions of status icons.

To set your daily water target:

1. From  **Samsung Health**, tap **Water**.
2. Swipe to the bottom of the screen and tap **Set target**.
3. Set the number for your target, and tap **Done**.

## Together

Compete with other Samsung Health users.

### Steps leaderboard

Add challenges through Samsung Health on your smartphone.

- From Apps, tap  **Samsung Health** > **Together** > **Start**. Here you can add friends and challenges.

## Settings

Customize your Samsung Health settings.

1. From  **Samsung Health**, tap **Settings**.
2. Tap an item from one of the following categories to customize:
  - **Measurement:** Configure automatic heart rate, stress, and blood oxygen during sleep measurements.
  - **Auto detect workouts:** Set the watch to recognize and encourage you when it detects that you are exercising.
  - **Inactive time:** Set the watch to alert you if you have been still for almost an hour.
  - **Share data with devices and services:** Configure connected services such as the Health platform.

## Samsung Health Monitor

Use the Samsung Health Monitor app to track your blood pressure and record electrocardiogram (ECG) measurements, analyze them quickly, and share the results with experts.

To view detailed reports of your blood pressure and ECG readings on your smartphone, install the Samsung Health Monitor app. You can download the app from the Galaxy Store or the Google Play™ store.

1. From your watch, tap  **Samsung Health Monitor**. If necessary, update the app to the latest version.
2. Tap **Continue** and create your profile.

### Measure ECG

Use your Galaxy watch to record ECG for 30 seconds similar to a standard single-lead ECG. The ECG Monitor app will also check the recording for signs of Atrial Fibrillation—a common form of irregular heart rhythm.

Requires Samsung Galaxy smartphone with Android 7 or later, and Samsung Health Monitor app (available only at the Samsung Galaxy app store).

 **CAUTION** The ECG app is not intended for users with known arrhythmias other than atrial fibrillation or users under 22 years old. Users should not interpret or take clinical action based on the device output without consultation of a qualified healthcare professional. The ECG app is not intended to replace traditional methods of diagnosis or treatment.

1. From  **Samsung Health Monitor**, tap **ECG**.
2. Rest your finger lightly on the **Home** key to begin the ECG.
  - After a moment, your ECG is displayed on the screen.
3. Tap **Add** to add any symptoms you are experiencing.
4. Tap **Done** when you are finished.

## Share your report

You can view your ECG readings as daily, weekly, and monthly charts, or view detailed reports for each measurement. You can share the PDF report of your ECG recording with your healthcare provider using Samsung Health Monitor app on your compatible Galaxy phone.

1. From your smartphone, tap  **Samsung Health Monitor**.
2. Tap the **ECG** tab to view your measurements.
3. Tap **See details** to view the latest report or **View history** to see all available reports.
4. Tap **Share this report** and choose a sharing method to send a PDF.

# Google

Enjoy these apps from Google. Certain apps require a Google Account. Visit [google.com](https://www.google.com) to learn more.

[Play store](#) | [Maps](#)

## Play store

Find new, recommended, and essential apps as well as watch faces and games in the Google Play store.

- From Apps, tap  **Play store**.

## Maps

Get directions and other location-based information. You must enable location services to use Google Maps. For more information, see [Location](#).

- From Apps, tap  **Maps**.

# Microsoft

The following Microsoft apps may be preloaded on your device. Apps can be downloaded from Galaxy Store and the Google Play store.



## Outlook

View new emails on your watch.

1. From Apps, tap  **Outlook**.
2. Tap a message to view its content.

## View calendar events

View your Outlook calendar events on your watch.

- From  **Outlook**, tap an event to view its content.

## Notification settings

Customize Microsoft Outlook

- From  **Outlook**, tap **Notifications** and tap an option to customize:
  - **Mail:** Choose to receive notifications in the same way as your phone, or set a vibration option.
  - **Calendar:** Choose to receive notifications in the same way as your phone, or set a vibration option.

# Settings

---

Access Settings

Connections

Notifications

Sounds and vibration

Display

Device maintenance

Accessibility

Security and privacy

Accounts

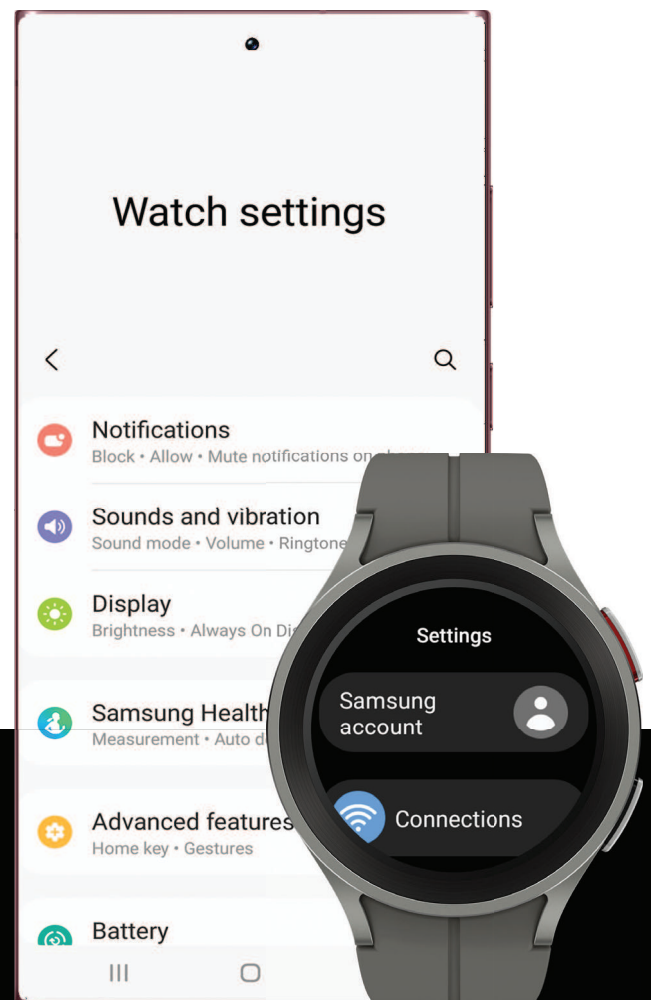

Other settings





# Access Settings

You can personalize your device by configuring various setting options.

- From Apps, tap  **Settings**, or swipe down from the top of the screen to open the status panel and tap  **Settings**.

## Connections

Manage connections between your device and a variety of networks and other devices.

[Bluetooth](#) | [Wi-Fi](#) | [NFC](#) | [Disconnection alerts](#) | [Airplane mode](#) | [Mobile networks](#) | [Data usage](#)

### Bluetooth

Use Bluetooth to connect the watch to a smartphone or an optional headset for playing music (headset not included).

1. From  **Settings**, tap  **Connections** > **Bluetooth**.
2. Tap  to turn on the feature.



### Wi-Fi

Activate the Wi-Fi feature to connect to a Wi-Fi network.

1. From  **Settings**, tap  **Connections** > **Wi-Fi**.
2. Tap  to turn on the feature.

## Connect to a Wi-Fi network

This feature is available when the watch is not connected to the smartphone through Bluetooth.



1. From  **Settings**, tap  **Connections** > **Wi-Fi**.
2. Tap a network from the **Available networks** list.
  - Networks that require a password display a lock icon.
3. Enter the password if required, and tap **Connect**.



**NOTE** Once the watch connects to a Wi-Fi network, the watch reconnects to that network each time it is available without requiring a password. To prevent the watch connecting to the network automatically, select the network, and then tap **Forget**.

## NFC

Near Field Communication (NFC) allows you to communicate with another device without connecting to a network. Make payments and buy tickets for transportation or events after downloading and configuring the required apps.

1. From  **Settings**, tap  **Connections** > **NFC**.
2. Tap  to enable the feature.
3. Tap **Payment** to set the default payment app for mobile payments.
  - To use a payment app that is open, tap **Pay with open app**.

## Make payments with the NFC feature



Before you can use the NFC feature to make payments, you must register for the mobile payment service. To register or get more information about the service, contact your service provider.

- Touch the top of the watch's touchscreen to the credit card reader.

 **NOTE** The payment services list may not include all available payment apps.

## Open with NFC

You can select supported apps to open with NFC.

1. From  **Settings**, tap  **Connections** > **NFC**.
2. Tap **Others**, and select an app.

## Disconnection alerts



Receive alerts when disconnected from Bluetooth.

1. From  **Settings**, tap  **Connections** > **Disconnection alerts**.
2. Tap an alert style to select it.

## Airplane mode



Airplane mode disconnects your device from all networks and turns off connectivity features, such as phone calls and Wi-Fi.

- From  **Settings**, tap  **Connections** > **Airplane mode** to enable this option.

 **TIP** You can also access Airplane mode from Quick settings. Swipe down from the top of the watch, and tap .



## Mobile networks

Customize your mobile networks. This feature is only available on LTE models. When you are not subscribed to a service provider's mobile plan, the mobile network is turned off to save battery power and network services may not be available.

1. From  **Settings**, tap  **Connections**.
2. Tap **Mobile networks**, and tap an option for mobile network use.
3. Swipe down and tap **Mobile plans** to view available mobile plans for your device

## Data usage

Explore options for your data plan. This feature is only available on the LTE model.

1. From Apps, tap  **Settings**, tap  **Connections**.
2. Tap **Data usage** and tap an option:
  - **Start billing cycle on:** Change the monthly date to align with your carrier's billing date (if applicable).
  - **Set data limit:** Enable the data limit feature.
  - **Data limit:** Customize your data limit.



# Notifications

You can prioritize and streamline app alerts by changing which apps send notifications and how notifications alert you.

[Notification settings](#) | [Advanced notification settings](#) | [Wireless emergency alerts](#)



## Notification settings

Coordinate notifications between your phone and watch.

- From  **Settings**, tap  **Notifications**, and tap an option to enable it:
  - **Show phone notifications on watch:** When the phone is not in use receive phone notifications on your watch.
  - **Mute notifications on phone:** Notifications on your phone will be muted while you are wearing your watch.



## Advanced notification settings

Use these options to determine block out time where notifications are turned off, and during which time periods you want to enter this mode.

- From  **Settings**, tap  **Notifications**, and tap options under **Advanced settings** to enable:
  - **Notification indicator:** Show indicator for unread notifications.
  - **Read notifications aloud:** When headphones are connected the watch can read your notifications aloud.
  - **Show with details:** Show the details of new notifications automatically.
  - **Turn on screen:** Turn on the watch screen when notifications are received.
  - **Turn on for new apps:** Automatically turn on notifications for newly installed apps.

## Wireless emergency alerts

Emergency alerts notify you of imminent threats and other situations. There is no charge for receiving an Emergency alert message.

- From  **Settings**, tap  **Notifications** > **Wireless emergency alerts**.
  - **Allow alerts:** Allow your watch to receive wireless emergency alert notifications.
  - **Alerts:** Choose which alert types you would like to receive on your watch.
  - **Emergency alert history:** View previous alerts.
  - **Alert preferences:** Customize alert reminders, accessibility options, and more.



## Sounds and vibration

Configure the vibrations used to indicate notifications, screen touches, and other interactions.

[Sound mode](#) | [Vibration](#) | [Call vibration](#) | [Notification vibration](#) | [Volume](#) | [Ringtone](#) | [Notification sound](#) | [System vibration](#) | [System sounds](#)



### Sound mode

Switch between sound modes, while preserving the individual sound settings you have made.

1. From  **Settings**, tap  **Sounds and vibration**.
2. Tap an option under **Sound mode**:
  - **Sound:** Enable sounds for notifications and alerts.
    - **Vibrate with sound:** Set your device to vibrate in addition to ringing when you receive an alert (This option is only available if Sound is enabled.)
  - **Vibrate:** Use vibration only for notifications and alerts.
  - **Mute:** Set your device to make no sounds.



## Vibration

Set how long and intensely the device vibrates for notifications.

1. From  **Settings**, tap  **Sounds and vibration** > **Vibration**.
2. Select options under **Vibration duration** and **Vibration intensity** to set your preference.

## Call vibration

Vibrate for calls.

1. From  **Settings**, tap  **Sounds and vibration**.
2. Tap **Call vibration** and select a vibration pattern.

## Notification vibration

Choose a vibration pattern for new notifications.

- From  **Settings**, tap  **Sounds and vibration** > **Notification vibration** and select a vibration pattern.

## Volume

Set volume levels.

1. From  **Settings**, tap  **Sounds and vibration** > **Volume**.
2. Tap a mode to customize the volume level.

## Ringtone

Choose from preset ringtones or add your own.

1. From  **Settings**, tap  **Sounds and vibration** > **Ringtone**.
2. Tap a ringtone to hear a preview and select it.

## Notification sound

Choose from preset notification sounds.

1. From  **Settings**, tap  **Sounds and vibration** > **Notification sound**.
2. Tap a notification sound to hear a preview and select it.



## System vibration

Enable vibrations when the watch screen is tapped.

- From  **Settings**, tap  **Sounds and vibration** > **System vibration** to enable.

## System sounds

Enable sounds for actions like tapping the screen and charging the watch.

1. From  **Settings**, tap  **Sounds and vibration**.
2. Tap **System sounds**, and then an option to enable it:
  - **Ticking**: Hear a ticking sound.
  - **Hourly chime**: Hear a sound and feel a vibration at the start of each hour.
  - **Touch**: Play tones when you touch or tap the screen to make selections.
  - **Unlock**: Play a sound when you lock or unlock the screen.
  - **Charging**: Play a sound when a charger is connected.
  - **Dialing keypad**: Play a tone when dialing numbers on the Phone keypad.



## Display

You can configure the screen brightness, timeout delay, font size, and many other display settings.

[Adjust screen brightness](#) | [Always on Display](#) | [Screen wake-up](#) | [Show media controls](#) | [Set the screen timeout](#) | [Show last app](#) | [Font](#) | [Touch sensitivity](#) | [Show charging info](#)

## Adjust screen brightness



Manually adjust the brightness of the display.

- From  **Settings**, tap  **Display** and select an option:
  - **Brightness**: Manually adjust the brightness of the display.
  - **Auto brightness**: Set the watch to automatically adjust the brightness depending on ambient light conditions.





## Always on Display

Keep the screen on without unlocking your device using Always On Display (AOD).

- From  **Settings**, tap  **Display**, and tap **Always on Display** to enable the feature.

## Screen wake-up

Use a gesture to turn on the watch screen.

- From  **Settings**, tap  **Display**, and tap an option under **Screen wake-up** to enable:
  - **Raise wrist to wake**: Lift your wrist to turn on the watch screen.
  - **Touch screen to wake**: Touch the watch screen to turn it on.

## Show media controls

Show controls on your screen when you start playing audio or video on your phone.

- From  **Settings**, tap  **Display**, and tap **Show media controls** to enable the feature.

## Set the screen timeout

Set the length of time the watch waits before turning off the display's backlight.

- From  **Settings**, tap  **Display** > **Screen timeout**, and select a timeout value.



## Show last app

Set the length of time the watch displays the last app used when you turn the screen on.

- From  **Settings**, tap  **Display** > **Show last app**, and select a timeout value.



## Font

Customize the font style and size on your watch.

- From  **Settings**, tap  **Display**, and tap an option under **Font** to customize:
  - **Font style:** View and select a font.
  - **Bold font:** Enable to display text in bold.
  - **Font size:** Choose from small, medium, and large.

## Touch sensitivity

Set the watch to allow use of the touch screen with gloves on.

1. From  **Settings**, tap  **Display** > **Touch sensitivity**.
2. Tap  to enable this feature.

## Show charging info

Display the battery level until full.

- From  **Settings**, tap  **Display** > **Show charging info** to enable the feature.

## Device maintenance

View the status of your device's battery, storage, and memory. You can also automatically optimize your device's system resources.

[Battery](#) | [Power saving mode](#) | [Watch only mode](#) | [Text to speech](#) | [Date and time](#) | [Orientation](#) | [Connect to a new phone](#) | [Reset the Watch](#) | [Location](#)

## Battery



View your battery level percentage and remaining hours.

- From  **Settings**, tap  **Battery** to view the remaining battery life for your watch.

## Power saving mode

Activate Power saving mode to save battery power by limiting the watch's functions, such as:

- Use a grayscale Home screen.
- Turn off all functions except calls, messages, and notifications.
- Turn off Wi-Fi and mobile networks (if applicable).
- Limit performance.



1. From  **Settings**, tap  **Battery**.
2. Tap **Power saving** to enable the feature.

To disable Power saving mode:

- From the Home screen, swipe from the top of the screen down to open the Quick settings panel. Tap  **Power saving** to turn off the feature.



## Watch only mode

Activate Watch only mode to save battery power by limiting the watch's functions to only showing the time.

1. From  **Settings**, tap  **Battery** > **Watch only**.
2. Tap **Turn on**.
  - Press the **Home** key to show the time.
  - Press and hold the **Home** key to turn watch only mode off.



## Text to speech

To set accessibility settings related to Text to speech:

- From  **Settings**, tap  **General** > **Text-to-speech** and select a mode:
  - **Preferred engine**: Choose your default TTS engine.
  - **TTS engine settings**: Install voice data for use with text-to-speech and view the TTS version information.
  - **Language**: Choose the language for spoken text.
  - **Speech rate**: Set the speed at which the text is spoken.



## Date and time

You can set the date and time manually. These options are only available when your watch is not connected to your mobile device.

- From  **Settings**, tap  **General** > **Date and time**.
  - **Automatic:** Use the network to set date and time.
  - **Set date:** Set the date manually.
  - **Set time:** Set the time manually.
  - **Select time zone:** Select the time zone manually.

## Orientation

The screen orientation will change based on your choices. For accurate ECG measurements, choose the orientation the matches how you wear your watch.

- From  **Settings**, tap  **General** > **Orientation** and select an option:
  - Under Wrist, select the hand you are wearing the watch on.
  - Under Key position, select which side of the screen the keys are on.



## Connect to a new phone

Connect your watch to a new mobile device. For more information, see [Back up data](#).

- From  **Settings**, tap  **General** > **Connect to new phone** and follow the prompts.



## Reset the Watch

Reset settings to their factory default values and delete all data.

1. From  **Settings**, tap  **General** > **Reset**.
2. Tap **Reset** again to confirm.

## Location

Some apps may require location services to be turned on for full functionality.

1. From  **Settings**, tap  **Location**.
2. Tap  to enable this feature.
3. Tap **Permissions** to view apps and features that have permission to access your location information.

## Accessibility



Accessibility services are special features that make using the device easier for those with certain physical disabilities.

For more information about Accessibility for Samsung products, please contact us at [accessibility@sea.samsung.com](mailto:accessibility@sea.samsung.com).

[TalkBack](#) | [Visibility enhancements](#) | [Hearing enhancements](#) | [Interaction and dexterity](#) | [Accessibility](#) | [Installed services](#)



## TalkBack

Receive spoken feedback when using your device, such as what you touch, select, or activate.

1. From  **Settings**, tap  **Accessibility** > **TalkBack**.
2. Tap  to enable the feature.
  - To configure TalkBack, tap **Settings**.



## Visibility enhancements

You can configure Accessibility features to assist with visual aspects of your device.

- From  **Settings**, tap  **Accessibility** > **Visibility enhancements** for the following options:
  - **High contrast fonts:** Adjust the color and outline of fonts to increase the contrast with the background.
  - **Color correction:** Adjust the color of the screen if you find it difficult to see some colors.
  - **Color inversion:** Reverse the display of colors from white text on a black background to black text on a white background.
  - **Add color filter:** Adjust the screen colors if you have difficulty reading the text.
  - **Remove animations:** Remove certain screen effects if you are sensitive to motion.
  - **Reduce transparency and blur:** Reduce visual effects on dialogs and menus to make them easier to see.
  - **Magnification:** Triple tap to zoom in and out. After zooming out, drag two fingers apart or together to adjust the zoom level.
  - **Bold font:** Enable to display text in bold.
  - **Font size:** Adjust the size of the font.



## Hearing enhancements

You can configure Accessibility features to assist with audial aspects of the device.

- From  **Settings**, tap  **Accessibility** > **Hearing enhancements** and tap an option:
  - **Mute all sounds:** Turn off all notifications and audio for privacy.
  - **Mono audio:** Switch audio from stereo to mono when using one earphone.
  - **Left/right sound balance:** Use the sliders to adjust the left and right balance for connected audio and device speakers.



## Interaction and dexterity

You can configure Accessibility features to assist with limited dexterity when interacting with your device.

- From  **Settings**, tap  **Accessibility** > **Interaction and dexterity** and tap an option:
  - **Universal gestures:** Control your device with your customized gestures.
  - **Touch and hold delay:** Select a time interval for this action.
  - **Tap duration:** Set how long an interaction must be held to be recognized as a tap.
  - **Ignore repeated touches:** Set a time duration in which to ignore repeated touches.

## Advanced settings

You can configure Accessibility features.

- From  **Settings**, tap  **Accessibility** > **Advanced settings** for the following options:
  - **Accessibility shortcuts:** Select and enable accessibility function shortcuts.
  - **Vibration watch:** The watch will use vibrations to communicate the time.
  - **Time to take action:** Choose how long to show messages that ask you to take action, but are visible only temporarily (like notifications).

## Installed services

You can install additional assistance services for your device.

- From  **Settings**, tap  **Accessibility** > **Installed services** to see a list of installed services.



# Security and privacy

You can secure your device and protect your data by setting a screen lock.

[Set a screen lock](#) | [Permission manager](#)

## Set a screen lock



It is recommended that you secure your device using a screen lock.

1. From  **Settings**, tap  **Security** > **Lock**.
2. Tap **Type** to select a screen lock type:
  - **Pattern:** Create a pattern that you draw on the screen to unlock your device.
  - **PIN:** Set a PIN to use for unlocking the device when it is removed from your wrist and the screen is turned off.
  - **None:** Do not lock the screen.
3. Tap **Hide information** to keep notifications and personal information hidden on the watch screen.



## Permission manager

Apps might access features of your watch that you permit them to (like the sensors, microphone, or location) when they are running in the background, not just when you are using the app. You can set your watch to notify you when this happens.

1. From  **Settings**, tap  **Privacy** > **Permission manager**.
2. Tap a category, then tap an app to select which permissions you want to be notified about.

## Accounts

Set up and manage your accounts.

[Samsung account](#) | [Google account](#)

### Samsung account

Sign in to your Samsung account to access exclusive Samsung content and make full use of Samsung apps.

- From  **Settings**, tap  **Account and backup** > **Samsung account** to add your account information.

 **TIP** You can also quickly access your Samsung account from the top of the settings menu.

### Google account

Sign in to your Google Account to access your Google Cloud Storage, apps installed from your account, and make full use of your device's Android™ features.

- From  **Settings**, tap  **Account and backup** > **Google account** to add your account information.

# Other settings

Configure features on your device that make it easier to use.

[Software update](#) | [Tips and tutorials](#) | [About watch](#)

## Software update



Check for and install available software updates for your device. Options may vary by carrier.

- From  **Settings**, tap  **Software update** to check for available software updates.

## Tips and tutorials



View tips and techniques as well as tutorials for your device.

- From  **Settings**, tap  **Tips and tutorials** to view tips on your phone, and tutorials on your watch.

 **TIP** To view the user manual from the  **Galaxy Wearable** app on your smartphone, tap  **Tips and user manual**.

## About watch

View information about the watch.

- From  **Settings**, tap  **About watch** to view information about your watch:
  - **Device info:** View your device name and Bluetooth identifier.
  - **Watch phone number:** View the phone number assigned to your watch (LTE model only).
  - **Model number:** Check your watch's model number.
  - **Serial number:** View your watch's serial number.
  - **IMEI:** View your watch's IMEI number.
  - **Storage:** Check the available storage space.
  - **Device:** Access device information about the watch.

- **Legal info:** Access legal information related to the watch.
- **Software:** Check your watch's software version and security status.
- **Battery:** Check the watch's battery voltage and capacity.

# Learn more

---

## Videos

[youtube.com/samsungcare](https://youtube.com/samsungcare)

## Tips

[samsung.com/us/support/tips](https://samsung.com/us/support/tips)

## Samsung Care

[samsung.com/us/support](https://samsung.com/us/support)

## Talk to an agent

Contact us on [Facebook Messenger](#)

Find us on [Facebook](#)

Follow us on [Twitter](#)

# Legal information

---

READ THIS INFORMATION BEFORE USING YOUR MOBILE DEVICE.

**Arbitration Agreement** - This Product is subject to a binding arbitration agreement between you and SAMSUNG ELECTRONICS AMERICA, INC. ("Samsung"). You can opt out of the agreement within 30 calendar days of the first consumer purchase by emailing [optout@sea.samsung.com](mailto:optout@sea.samsung.com) or calling 1-800-SAMSUNG (726-7864) and providing the applicable information.

The full Arbitration Agreement, Standard One-year Limited Warranty, End User License Agreement (EULA), and Health & Safety Information for your device are available online at <https://www.samsung.com/us/Legal/Gear-HSGuide>.

## Restricting children's access to your mobile device

Your device is not a toy. Do not allow children to play with it because they could hurt themselves and others, or damage the device, or make calls that increase your device bill. Keep the device and all its parts and accessories out of the reach of small children.

## Samsung Electronics America, Inc.

Address:

85 Challenger Road  
Ridgefield Park  
New Jersey 07660

Phone: 1-800-SAMSUNG (726-7864)

Internet: [samsung.com](http://samsung.com)

©2022 Samsung Electronics America, Inc. Samsung, Samsung Galaxy, and Samsung Health are all trademarks of Samsung Electronics Co., Ltd.

Other marks are the property of their respective owners.



Some multimedia (audio/video) files contain Digital Rights Management (DRM) technology to verify you have the right to use the files. Preloaded apps on your device may not be compatible with DRM-protected files.

Screen images are simulated. Appearance of device may vary.

Descriptions are based on the device's default settings. Some content may differ depending on carrier, model, or software.

The actual available capacity of the internal memory is less than the specified capacity because the operating system and default applications occupy part of the memory. The available capacity may change when you upgrade the device.

Please check with your service provider to verify qualifying services/features.