



BOULT AUDIO

PROBASS GEARPODS USER MANUAL

For better sound quality experience, suggest use
IOS 8.0/ Android 4.3 or above operating system.



Product Introduction

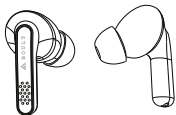

TWS Earbuds

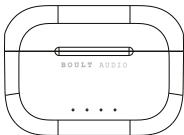

Earbud Charging Case

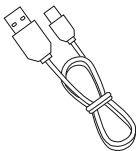

USB Cable

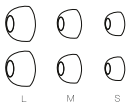

Ear Cap



User Manual

Summary of Button Functions

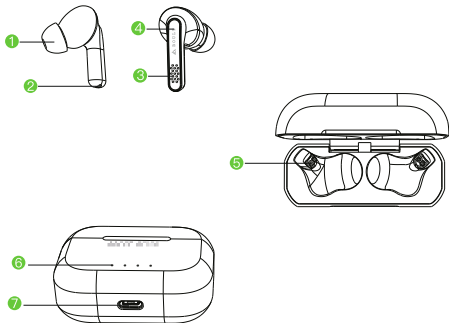

- ① Silicone Eartips
- ② Pods Charging Pin
- ③ Earbuds Indicator
- ④ Touch Control Area
- ⑤ Case Charging Pods for Pods
- ⑥ Charging Pods Indicator
- ⑦ Type- C Charging Connector

1. Connecting to Earbuds

First time Setup:

Take earbuds out from the case, the earbuds will automatically turn on. Turn your device Bluetooth on. Search for "Boult Audio Gearpods" and select to connect.

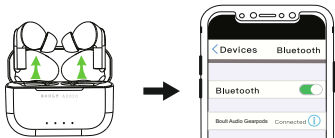

Regular use :

Once next use, the earbuds will automatically connect with a preconnected device.

2. Start Listening

Place the earbuds into your ear and twist slightly for a comfortable and snug fit.



Note: Regularly clean the dust mesh after use to avoid the sound being blocked by dirt and debris.

3. Power On & Off

Power-On

- Remove the earbuds from the case, they will automatically turn on and pair with each other.
- Long press the touch control area on both earbuds at the same time for 2 seconds, then the earbuds will turn on and pair with each other.

Light status : One side flash red and blue LED light alternatively, another side flash blue LED light quickly.

Power-Off

- Earbuds will automatically turn off and enter charging mode when they are placed in the case.
- Disconnecting the Bluetooth from device and laying the earbuds down for 3 mins will turn them off.
- Disconnecting the Bluetooth from device, long press the touch control area for 5s and the earbuds will turn off.

4. Start Charging

Charging the Earbuds

Place the earbuds into the case, once the charging pin connects, the light on the charging case will turn on to display the case battery remains, then the first and forth light keep white on indicate the earbuds charging, light off means the battery is full.

Charging the Case

Plug the charging case into 5V/1A adapter with a Type-C cable (include in the package). The charging light will flash white when charging. When full the white light will stay on and the case should be disconnected from the power source.

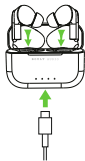

5. Specification

Bluetooth Standard: Version 5.1

Bluetooth Profile: HSP/HFP/A2DP/AVRCP

Output Voltage of Base: 3.7V

Charging time Earbuds- 1.5H, Charging case- 1H

Working distance: 10M

Compatible System: Android/IOS/Windows

Music Play/Pause	Single Click on L or R earbud
Next Song	Double click the R earbud
Previous Song	Double click the L earbud
Pick up call	Single Click on L or R earbud
End call/Reject call	Double-click on L or R earbud
Voice Assistant	Long press 3 Seconds L or R earbud

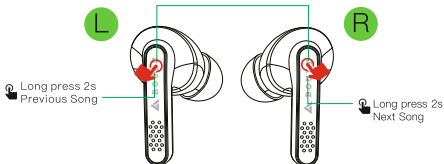

6. Clear to pairing

Clear the pairing record of earbuds and mobile phones:

Take out the earbuds from the charging case, and touch the left and right earbud 5 times, it will clear the record of the Bluetooth device. Then search for the Bluetooth name "Boult Audio Gearpods" to pair.

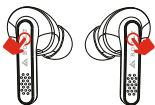

- Touch 5 times



- Search the Bluetooth and connect

Resume pairing of left and right earbuds:

Put earbuds in the charging case and charging, then take earbuds out of the charging case when they charging a few minutes. they will enter into pairing mode automatically.

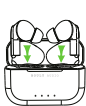

- Put in the charging case and charging

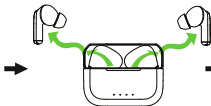

- Take out of charging case



- Pairing automatically

Trouble Shooting

P: The earbuds don't pair with each other?

A: Place the earbuds into case for charging a few seconds. take them out of the case and try to connect again.

P: The earbuds don't charge when place into the case.

A: Check to see if the charging case light will turn on when earbuds are placed inside. If it doesn't light up charge the case first.

P: The sound is imbalanced between the left and right side.

A: Please clean the earbuds mesh after use.