

# Godrej

**Protection of Environment:**

Protection of environment" is one of the core values of Godrej and we seek your co-operation to make sure that the product, packaging and plastic material is not disposed as unsorted municipal waste.



This symbol is known as the "Crossed-out Wheellie Bin Symbol". It means that the product should not be disposed of with your general house-hold waste.

It should be disposed of only through the company's collection points with special treatment so as to prevent any damage to the environment. Please call: **1800 209 5511** for applicable buy back arrangement or visit: [www.godrejappliances.com/green-think](http://www.godrejappliances.com/green-think) for details about Godrej Appliances authorised collection points.

# Godrej

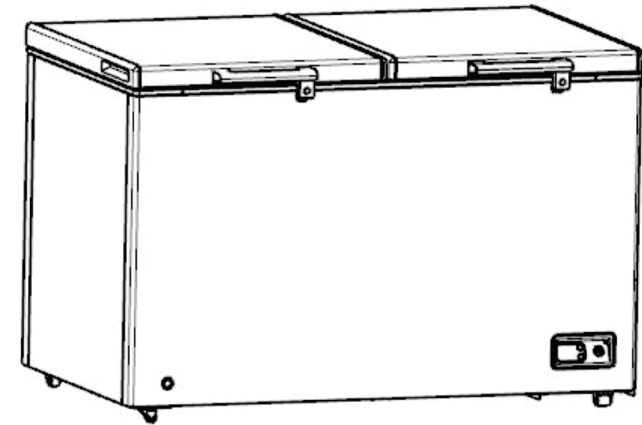

## USER MANUAL

FREEZER / COOLER CONVERT

## CONTENT

1	Safety Warnings . . . . .	
	• Meaning of safety warning symbols . . . . .	3
	• Electricity related warnings . . . . .	3-4
	• Warnings related to use . . . . .	4
	• Safety warnings . . . . .	4
	• Warnings related to placing items . . . . .	5
	• Warnings related to disposal . . . . .	5
	• Proper use of Freezer/Cooler . . . . .	6
2	Model Specifications . . . . .	6
3	Important Instructions . . . . .	7
4	Transportation Instructions . . . . .	8
5	Installation Instructions . . . . .	8-9
6	Freezer Cooler Operation . . . . .	10-12
7	Maintenance of Freezer/Cooler . . . . .	
	• Cleaning . . . . .	12
	• Do's and Don'ts . . . . .	13
8	Trouble Shooting . . . . .	14
9	Handle Installation . . . . .	14
10	Installation Instruction . . . . .	15-16
11	Warranty . . . . .	17

Dear customer,

Welcome to the Godrej family!

Thank you for buying this freezer and giving us an opportunity to serve you.

To ensure that you get the best results from your new freezer, please take time to read through the simple instructions in this user manual. If you need any further assistance at any time, feel free to call us on **1800 209 5511** or write to us at [smartcare@godrej.com](mailto:smartcare@godrej.com).



We urge you to ensure that the packing material is disposed off in accordance with the current environmental requirements. When disposing off any freezer equipment, please contact your local waste disposal department for advice on safe disposal.

This appliance must only be used for its intended purpose.

We thank you again for giving us the privilege to serve you, and look forward to a long and delightful association.

## SAFETY WARNINGS

### • Meaning of safety warning symbols

	This symbol indicates prohibited matters and behaviors that are forbidden. Non-compliance with the instructions may result in product damage or endanger the personal safety of users.
	This symbol indicates matters that must be followed, and behaviors that must be strictly executed in line with the operation requirements. Non-compliance with the instructions may result in product damage or endanger the personal safety of users.
	This symbol indicates matters that need attention. Due precautions are needed or injuries /damages will be caused.

### • Electricity related warnings

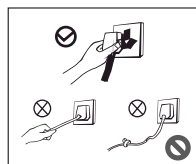

- Do not pull the power cord when pulling the power plug of the freezer. Please firmly grasp the plug and pull out it from the socket directly.
- Do not damage the power cord under any condition, so as to ensure safety use. Do not use freezer when the power cord is damaged or the plug is worn.
- Worn or damaged power cord shall be replaced in manufacturer-authorized maintenance stations.



- Please use a dedicated three-hole power socket which is 5A or more.
- The power cord should be firmly contacted with the socket to prevent fires. Please ensure that the grounding electrode of the power socket is equipped with a reliable grounding line.



- The freezer adopts 230V/50Hz AC power. Voltage fluctuations over the range of 230V $\pm$ 10% will cause malfunctioning or even damage. Hence, an appropriate automatic voltage regulator must be installed in concert with the AC power.
- In case of gas leakage, please open the doors and windows. Do not unplug the deep freezer and other electrical appliances, considering that any spark may cause a fire.

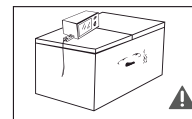

- To ensure safety, it is not recommended to place regulators, rice cookers, microwave ovens or other appliances on top of the freezer. Do not use electrical appliances in the food pantry or any atmosphere where the ambient temperature is above 43°C.

### • Warnings related to use

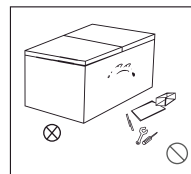

- Demolition or renovation of the deep freezer is prohibited. It is forbidden to damage the refrigerant lines. The repair and maintenance of the deep freezer must be carried out by professionals.
- Damaged power cord must be replaced by the manufacturer, its maintenance department or related professionals, in order to avoid danger.

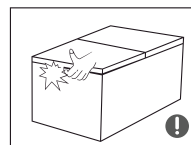

- The surroundings of the freezer should not be obstructed in order to maintain proper ventilation around the appliance. Keep a minimum space of 300mm all around the freezer.
- The gaps between doors and freezer body are small. Please do not put your hand in these areas to prevent squeezing of fingers.
- Do not pick/put foods or containers from/in the freezing chamber when the deep freezer is running, especially metal containers in order to avoid frostbite.

### • Safety warnings

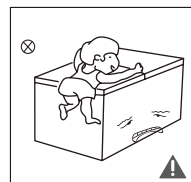

- Do not allow children to enter or climb the freezer to avoid injury.
- Do not spray or wash the freezer. Do not put the freezer in moist places as this may affect the electrical insulation properties of the freezer.

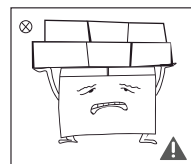

- Do not place heavy objects on top of the freezer considering that the object may fall when opening or closing the door, and accidental injuries might be caused.
- Please unplug the appliance while cleaning.
- Avoid switching on / off the appliance consecutively to prevent damage to the compressor.

### • Warnings related to placing items

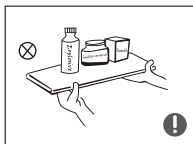

- Do not put flammable, explosive, volatile and highly corrosive items in the freezer to prevent damage to the product or cause fire.

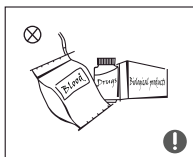

- This product is a freezer and is suitable only for the storage of foods. According to standards, when using for commercial purpose freezers shall not be used for other purposes, such as storage of blood, drugs or biological products.



- Do not place items such as bottled or sealed containers of fluid like bottled beers and beverages under freezer mode to prevent bursts and other losses.

### • Warnings related to disposal

- The freezer's R600a/R290 refrigerant and Cyclopentane foam material are combustible material and the discarded freezer should be isolated from fire sources. It cannot be burned. Please transfer the freezer to qualified professional recycling companies for processing in order to avoid damage to the environment or other hazards.
- Please remove the door and shelves of the freezer and place them away to avoid accidents if children enter and play in the freezer.

### • Proper use of Freezer/Cooler

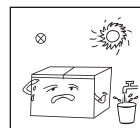

Keep away from heat and direct sunlight. Do not place the freezer in moist or wet places to prevent rust or reduction of insulating effect.

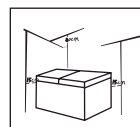

The space between the top of the freezer shall be greater than 80cm. The distance from both sides and the back shall be more than 30cm. This facilitates the opening & closing and heat dissipation.

Wipe the freezer inside and outside with a warm moist rag (add a small amount of detergent in the warm water. Use plain water for the final cleanse).

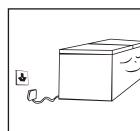

Do not switch on the connection 220~240V/50Hz(230V/50Hz) power until 6 hours after moving the freezer. The refrigerant needs time to settle.

Before placing frozen foods in your freezer, turn the freezer on and wait for 24 hours to make sure it is working properly and to allow the freezer to chill down to the optimum temperature. Temperature can be measured using a thermometer. Take care to maintain the temperature as recommended by food suppliers.

## MODEL SPECIFICATIONS

DESCRIPTION	325L	425L	525L
Climate Class	T	T	T
Rated Voltage	230V AC	230V AC	230V AC
Rated Frequency	50Hz	50Hz	50Hz
Refrigerant	R290	R290	R290
Net Weight	45kg	50kg	55kg
Foam Blowing Agent	Cyclopentane	Cyclopentane	Cyclopentane

## IMPORTANT INSTRUCTIONS

### WARNING!!

To obtain the best possible performance and trouble free operation from your appliance it is very important to read these instructions carefully.

- Don't connect the appliance to the electricity supply until all packing and transit protectors have been removed.
- Don't switch on the freezer for at least 8 hours, post arrival.
- Switch On the machine at least for 6 hours before initial loading or after long power off.
- If you are discarding an old product, remove or break the lock as a safety measure, to avoid children from getting trapped inside.
- This freezer must only be used for its intended purpose i.e. the storing and freezing of edible foodstuff.
- Do not dispose off the appliance in fire.
- Take care not to damage the cooling circuit/pipes of the appliance in transportation and in use. In case of damage, do not expose the appliance to fire or potential ignition source and immediately ventilate the room where the appliance is kept.
- On delivery, check to ensure that the product is not damaged and that all the parts and accessories are in perfect condition.
- We do not recommend the use of extension boards and multi-way adapters.
- Failure to observe these instructions may invalidate your right to free service during the guarantee period.

**WARNING!** Do not use mechanical devices or other means to accelerate the defrosting process, other than those recommended by the manufacturer.

**WARNING!** Do not damage the refrigerant circuit.

**WARNING!** Do not use electrical appliances inside the food storage compartments of the appliance, unless they are of the type recommended by the manufacturer.

- We suggest you keep this instruction booklet in a safe place for easy reference.

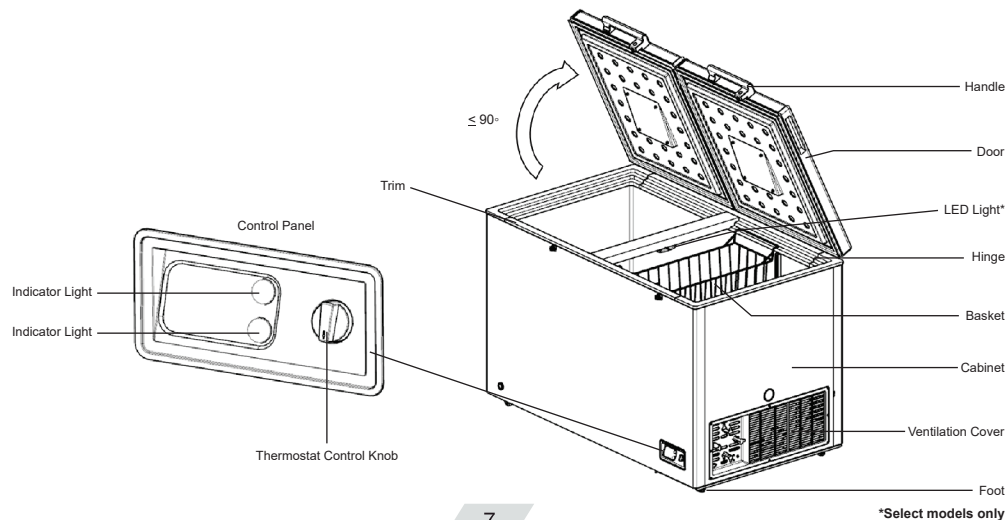

## TRANSPORTATION INSTRUCTIONS

The appliance should be transported only in an upright position. The packing as supplied must be intact during transportation.

1. Failure to comply with the above instructions could result in damage to the appliance. The manufacturer will not be held responsible if these instructions are not followed.
2. The appliance must be protected against rain, moisture and other atmospheric influences.

**IMPORTANT:** Care must be taken while cleaning / carrying the appliance.

**IMPORTANT:** This appliance is not designed for stacking with any other appliance. Do not attempt to sit or stand on top of your appliance as it is not designed for such use. You could injure yourself or damage the appliance.

**IMPORTANT:** Make sure that the mains cable is not caught under the appliance during and after carrying / moving the appliance, to avoid the mains cable getting cut or damaged.

When positioning your appliance take care not to damage your flooring, pipes, wall coverings etc. Do not move the appliance by pulling by the lid or handle. Do not allow children to play with the appliance or tamper with the controls. Our company declines to accept any liability should the instructions not be followed.

## INSTALLATION INSTRUCTIONS

1. Avoid placing the appliance near cookers, radiators or in direct sunlight as this will cause the compressor to run for long periods.
2. Make sure that sufficient room is provided around the appliance to ensure free air circulation. Ideally, a space of no less than a foot must be left around the freezer, and ensure you allow gaps.
3. The appliance should be installed on a flat surface.
4. Don't spray water on the freezer since it will weaken the insulation and cause electricity leakage.
5. Please refer 'Cleaning and Care' section for daily maintenance of your freezer.
6. If the Chest Freezer is installed in areas with high humidity; for e.g. basements, garages etc. in cold weather, then there are chances of water droplet formation on the outer surface due to condensation. This is quite normal and is not a fault. Remove the condensation by wiping with a dry cloth.
7. Do not push the freezer by pressing at lid. It may misalign the lid from its position and affect the performance.

## INSTALLATION INSTRUCTIONS

### Operation

Before you start using the CONVERTi (Freezer/Cooler), please go through the below mentioned guidelines to get optimum performance from your appliance.

1. The interior needs to be dry with free air circulation.
2. Clean the interior as recommended under 'CLEANING AND CARE'.
3. Insert the plug into the wall socket and switch on the electricity supply the red light will switch on. After sometime the green light will glow, indicating that the compressor is running.
4. You will hear a noise as the compressor starts up. The liquid and gases sealed within the refrigeration system may also give rise to noise, whether the compressor is running or not which is quite normal.
5. If you plan to store already frozen food, then open the freezer lid and check if the freezer has reached the correct temperature. Once the correct temperature has been reached, you can start storing your already frozen food. (See 'Storing Frozen Food'- Page <11>).
6. Do not load the appliance immediately after it is switched on. Wait until the correct storage temperature has been reached. We recommend that you check the temperature with an accurate thermometer (See 'Freezer/Cooler operation').

### Important Notes:

- Avoid opening the lid in case of a power failure. It will lead to cooling loss. If the failure lasts longer, then the food should be checked and eaten immediately or cooked and then re-frozen.
- If you find that the lid of the freezer is difficult to open just after you have closed it, don't worry. This is due to the pressure difference which will equalize and allow the lid to be opened normally after a few minutes. Do not use a knife or any sharp objects to open door or break vacuum at such instances.

## FREEZER / COOLER OPERATION

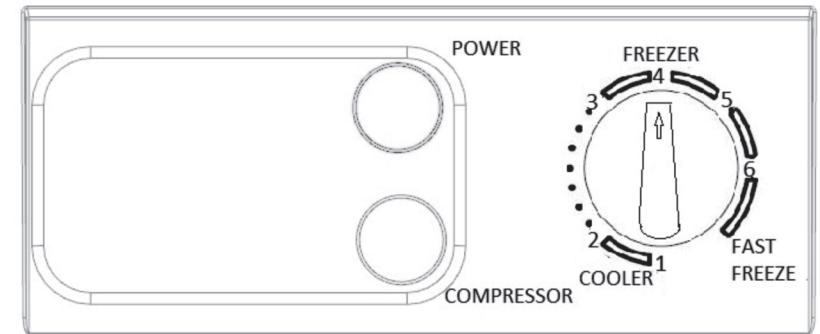

### Temperature adjustment

The temperature of the chamber is adjusted through the thermostat knob. The user can choose the right temperature zone according to their needs.

**For Cooler Mode** the temperature control knob needs to be **set at range 2**,  
**For Freezer Mode** the temperature control knob needs to be **set at range 6**

### Indicator lights

The indicator light -set is placed on the front side of the freezer for easy visibility.

Indicator lights mean the following:

- Red Light – Shows that the appliance is supplied with electric energy.
- Green Light – Shows that the compressor is working.

## STORING FROZEN FOOD

Pre-packaged commercially frozen food should be stored in accordance with the frozen food manufacturer's instructions.

To ensure that high quality is achieved by the frozen food manufacturer and the food retailer, please remember the following things:

1. After purchase, put packets in the freezer as quickly as possible to prevent defrosting.
2. Don't exceed the expiry dates of the food products.

## FREEZING FRESH FOOD

For freezing fresh food, store it near the side walls & away from already frozen food. This ensures fast freezing.

Do not freeze too large a quantity at a time.

The quality of the food is best preserved when it is frozen right through to the center as quickly as possible. Take special care not to mix already frozen food and fresh food.

## DEFROSTING

- Defrost twice a year or when a frost layer of around 7mm (1/4") has formed.
- You can defrost by switching off the freezer at the socket outlet and pulling out the mains plug.
- Extract the water conduit from chest freezer bottom and put in a water container to collect the drained water.
- 6 hours before the defrosting, please set the thermostat knob at 'MAX' position to make sure the food is at the lowest temperature when you get it out. All food should be wrapped in several layers of newspaper and stored in a cool place.
- Remove the freezer basket. Leave the lid open. Containers of warm water may be placed carefully in the freezer to speed up the defrosting.
- Never use hair dryers, electrical heaters or other such electrical appliances for defrosting. When defrosting has finished, drain out the defrost water which collects at the bottom of the freezer.

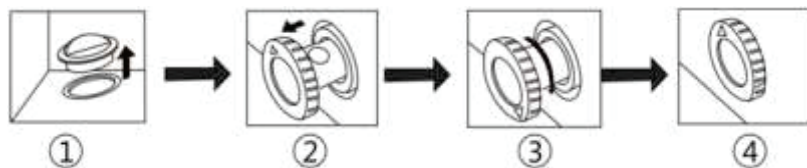

1. There is a water conduit at the bottom of the freezer. When defrosting, extract the rubber cover, defrosted water will flow out of the hole.

(NOTE: PLEASE REMOVE THE PLASTIC PLUG(CAP) DURING THE DEFROSTING AND PUT IT BACK AFTER DEFROSTING IS DONE)

2. Extract the water conduit by **20-25mm** until the water hole can be seen.

3. Twist the water conduit until the arrow points downward.
4. After defrosting is done, make sure there is no more water coming out from the water conduit before putting it back in place. Once the water conduit has been put in place make its arrow point upward.

### Important Notes:

- Do not use pointed or sharp-edged objects such as knives or forks to remove the frost.
- Never use hairdryers, electrical heaters or other such electrical appliances for defrosting.

## MAINTENANCE OF FREEZER/COOLER

### CLEANING AND CARE

- We recommend that you switch off the freezer from the main power outlet and pull out the mains plug before cleaning.
- Never use any sharp abrasive instrument, soap, household cleaner, detergent or wax polish for cleaning.
- Using damp clothes soaked with lukewarm water to clean the cabinet of the freezer.
- Use a damp cloth which has been dipped & squeezed in a solution of one teaspoon of soda bicarbonate mixed in a pint of water, to clean the interior and wipe it dry.
- Excess deposit of ice should be removed on a regular basis using a plastic ice scraper available. Large accumulation of ice will affect the performance of the freezer as it acts as an insulation.
- If the freezer is not going to be used for a long period of time, switch it off, remove all food and clean it.
- Check lid seals (gasket) regularly to ensure they are clean and free from food particles.

### Important Notes:

Never use water to wash the compressor position and wipe it with a dry cloth thoroughly after cleaning to prevent rust.

## DO'S AND DON'TS

### Do's

- Defrost food from the freezer thoroughly in a fridge or in a microwave oven. Follow defrosting and cooking instructions as given on food packet.
- Ensure that Chest Freezer lid is completely closed after each use.
- Defrost frozen meat completely before cooking.
- Close the lid gently.
- Check contents of the freezer at regular intervals.
- Clean and defrost your freezer regularly (See 'Defrosting').
- Adhere to 'Best Before', 'Use By' dates when you store.
- Store commercially frozen food in accordance with the instructions given on the packets that you buy.
- Always choose high quality fresh food and be sure it is thoroughly clean before you freeze it.
- Prepare foodstuff for freezing in small portions to ensure rapid freezing.
- Wrap all foods in aluminum foil or freezer quality plastic bags and make sure any air is excluded.
- Wrap frozen food when you buy it and put it in to the freezer as soon as possible.
- Store small items in the basket provided.
- Remove ice cream from the freezer about 10 minutes before serving.

### Don'ts

- Don't leave the lid open for long periods as this will make the freezer costlier to run and cause excessive ice formation.
- Don't use pointed or sharp edged objects such as knives, forks etc. to remove the ice.
- Don't put hot food in the freezer.
- Don't put liquid-filled bottles or sealed cans containing carbonated liquids into the freezer as they may burst.
- Don't store poisonous or dangerous substances in the freezer. Your freezer has been designed for the storage of edible foodstuffs only.
- Don't consume ice-cream and ice-cubes directly from the freezer. The low temperature may cause 'freezer burns' on lips.
- Don't freeze fizzy drinks.
- Don't keep frozen food which is thawed. It should be eaten within 24 hours or cooked and refrozen.
- Don't remove items from the freezer with wet hands.
- Don't shut the lid with force.

## PROBLEM SOLVING/TROUBLE SHOOTING

If the appliance does not operate when switched on, check that:

- The plug is inserted properly in the socket and that the power supply is on. (To check the power supply to the socket, plug in another appliance)
- The fuse has blown / circuit breaker has tripped / main distribution switch has been turned off.
- The temperature control has been set correctly.
- New plug is wired correctly if you have changed the fitted molded plug. If the appliance is still not operating after the above checks, please call the toll free service helpline number- 1800 209 5511.
- There is no heavy build up of frost.

## INSTRUCTION FOR HANDLE INSTALLATION

### Step 1

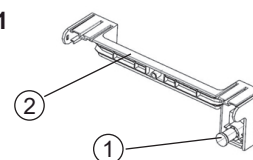

Take out Lock assembly (1) and handle back (2) from the bag and Insert Lock Assembly 1 in the handle back part 2.

### Step 2

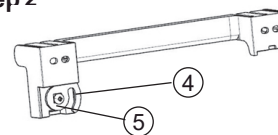

Fix lock lever (4) in the position as shown, at the back side with the small screw (5) provided in the bag

### Step 3

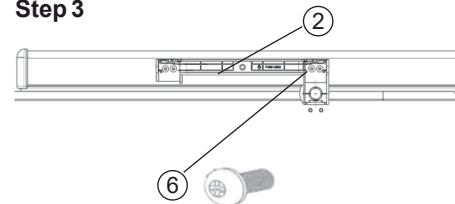

Fix handle back part (2) on lid using four long screws (6) provided in the bag

### Step 4

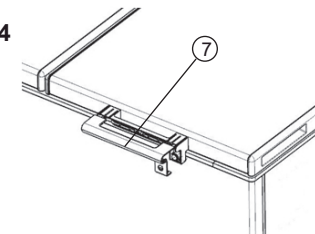

Insert handle front cover (7) in the handle back part (2) until a click at end.

### Step 5

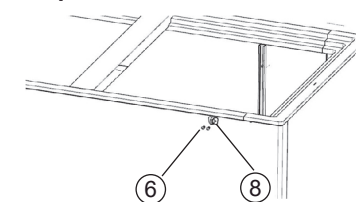

Screw the lock bracket (8) on the freezer cabinet with the help of another 2 long screws (6)

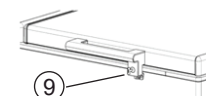

Use key (9) for the lock operation

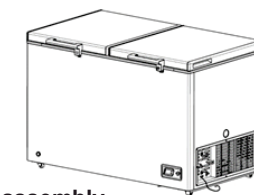

Complete assembly with handle



## Installation Instruction

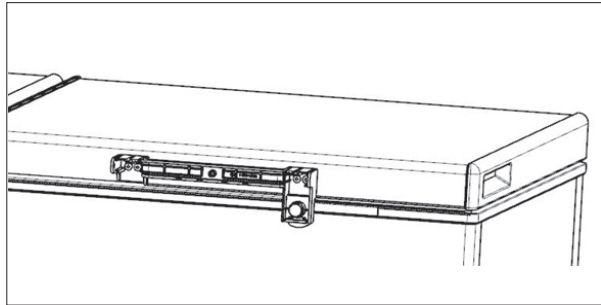

1. Fix the handle on the door with screws.

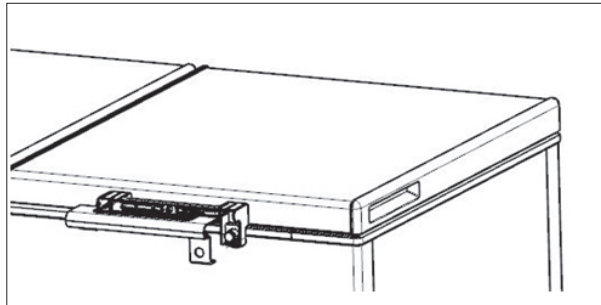

2. Put each side of the handle into the slot , then push the center of the cover to fix the handle.

## WARRANTY

The Godrej Chest Freezer comes with a FIVE year warranty on COMPRESSOR and a ONE year warranty on the appliance from the date of purchase, against defective material or workmanship. In case of any such defect found during the first year from date of purchase, Godrej & Boyce Mfg. Co. Ltd. - Appliance Division will undertake repairs to the warranted part free of charge, subject to the terms and conditions below. In the warranty period beyond the first year from date of purchase, only the the compressor will be provided free of cost. However, the appliance will be repaired on payment of necessary charges.

### INSTRUCTIONS FOR THE CUSTOMER

1. Kindly ensure that the dealer fills the warranty card correctly and completely.
2. You should retain the warranty card for record and produce the same in the event of any warranty repairs.
3. In the event of a defect developing in the product, contact the nearest authorized Godrej & Boyce Service Centre for obtaining warranty service and provide the defect, model details & serial no.
4. Earthing of the appliance is necessary to ensure safety.
5. Product will function between +/-5% of the rated voltage. For any fluctuation beyond the specified limit, company shall not be responsible and the warranty stands terminated.
6. Frequency must be between 5% variation of 50Hz. Beyond this, the company shall not be liable for any unforeseen hazards like fire, shock etc. and in turn, the warranty stands terminated.
7. The product must be maintained to ensure hygiene. If there are any insects, rodents etc. in it, obstructing the functioning of the product, the company shall not be responsible and in turn, the warranty stands terminated.
8. If you are moving house, it is essential that a Godrej service representative inspects the chest freezer at the time of re-installation at the new address. The warranty on the product/optional service contract for the sealed system of the appliance continues to be effective only if the product is found to be in working condition. The re-inspection will be done on the payment of necessary charges. We would also recommend that the product be insured against damage in transit.

### TERMS AND CONDITIONS

1. Repairs and replacements of parts will be carried out through the authorized Customer Service Centre.
2. All transportation and handling expenses incurred while repairing will be payable by the customer.
3. For any appliance installed beyond the municipal limits of the jurisdiction of the authorized customer service centre, charges towards technician's visit will be borne by the customer.
4. While the company will make every effort to carry out the repairs at the earliest, it however is made explicitly clear that the company is under no obligation to do so in a specified period of time and will not be held liable for any loss in case of delay.
5. The company/its authorized personnel will collect any parts, compressor or other components replaced.
6. Warranty does not cover accessories to the appliance.
7. Sealed system gas charging and consumables will be charged for any such repairs after one year from the date of purchase.
8. The company will take all necessary steps to repair the appliances supplied under the warranty and keep sufficient stock of the spare parts of the Appliance with them. However, in certain cases where the appliance cannot be repaired due to non availability of the spare parts, the company, at its sole discretion, may offer a replacement of the appliance to the purchaser of such an appliance, under a replacement offer. The replacement offer is subject to change from year to year and any discount given shall be applicable on the MRP of the product to be purchased as a replacement. A table giving the details of the replacement offer is available on [www.godrejsmartcare.com](http://www.godrejsmartcare.com).
9. The liability of the company is limited only to the chest freezer, and it would not be responsible for any goods being spoilt due to non-functioning of the product.
10. The decision of the company shall be final with respect to any disputes that arise in interpretation of the above terms. The courts of Mumbai shall have exclusive jurisdiction in case of any disputes

Godrej & Boyce Mfg. Co. Ltd.- Appliance Division

### CUSTOMER COPY

MODEL NO.  
UNIT SR. NO.

DATE OF PURCHASE

CUSTOMER'S NAME & ADDRESS

DEALER'S NAME & ADDRESS

TEL. \_\_\_\_\_

TEL. \_\_\_\_\_

Customer's Signature:

This warranty is valid only if it is filled in and stamped by our authorized dealer on the date of purchase.

### Overall warranty stands null and void if

1. The warranty card is not completed properly at the time of the purchase.
  2. The completed warranty card is not presented to the authorized personnel at the time of service of the product.
  3. The appliance is not operated according to instructions given in the User's Guide.
  4. Defects are caused by improper use, which shall be determined by the company personnel.
  5. Unauthorized person carries out any repair work.
  6. Defects are caused by reasons beyond control, like abnormal voltage, acts of God, or while in transit to service centre or purchaser's residence.
  7. The serial number is deleted, defaced or altered.
  8. Damage is caused to the appliance on any parts due to transportation or shifting.
- Warranty automatically expires after the stipulated period from the original date of purchase, even if the appliance was not in use for any time for whatever reasons.