

# Haier

## FULLY AUTOMATIC TOP LOADING WASHING MACHINE **USER'S MANUAL**

**MODEL**  
HWM100-678NZP

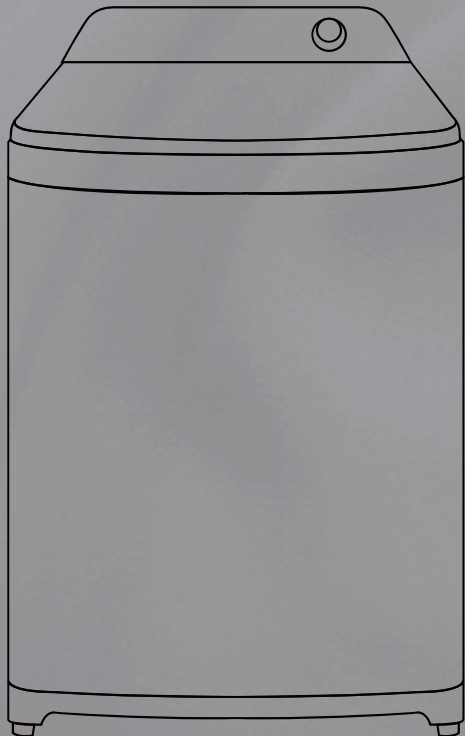

Please read this manual carefully before operating your washing machine and retain it for future reference.

0030513712



# CONTENTS

■ Product overview	1
■ Safety precautions	2
Description of symbols	2
Warning	2
Forbidden	3
Safety warning	4
■ Installation & adjustment	5
Install the bottom plate	5
Balance washing machine	5
Change the direction of the drain hose	5
Usage of the drain hose	6
Inlet pipe connection	6
■ Before washing	9
Check the following before washing	9
■ Operation	10
Loading your laundry	10
Usage of the detergent	10
Explanation of buttons	11
■ Cleaning or Maintenance	15
■ Trouble-shooting	16
■ Packing list	18
■ Specification	18

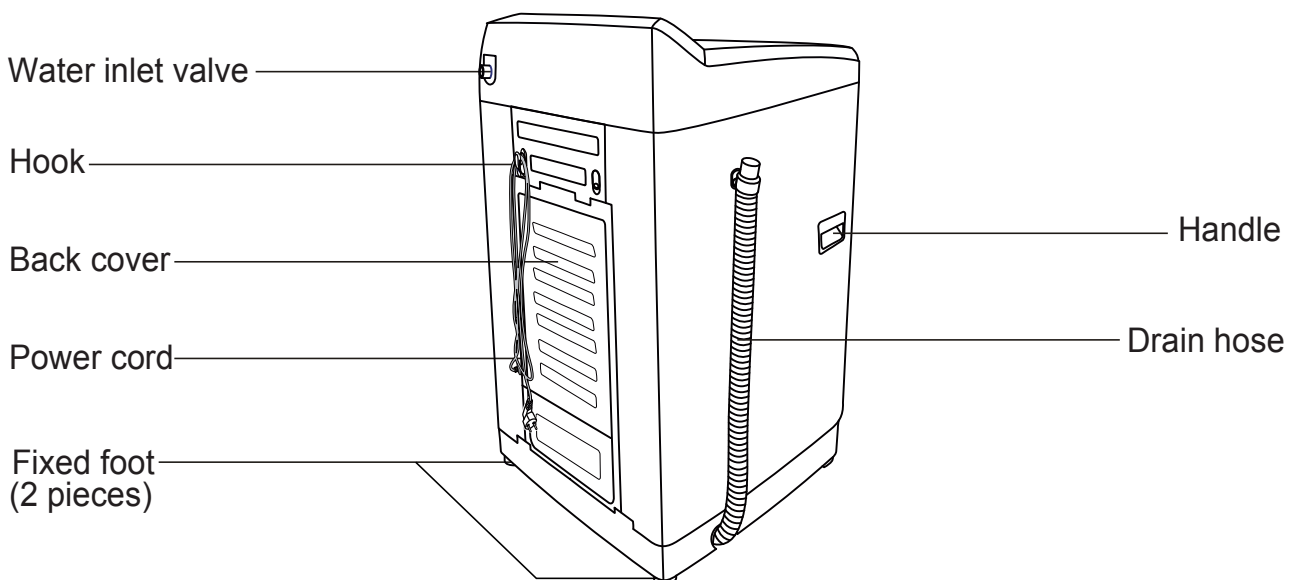
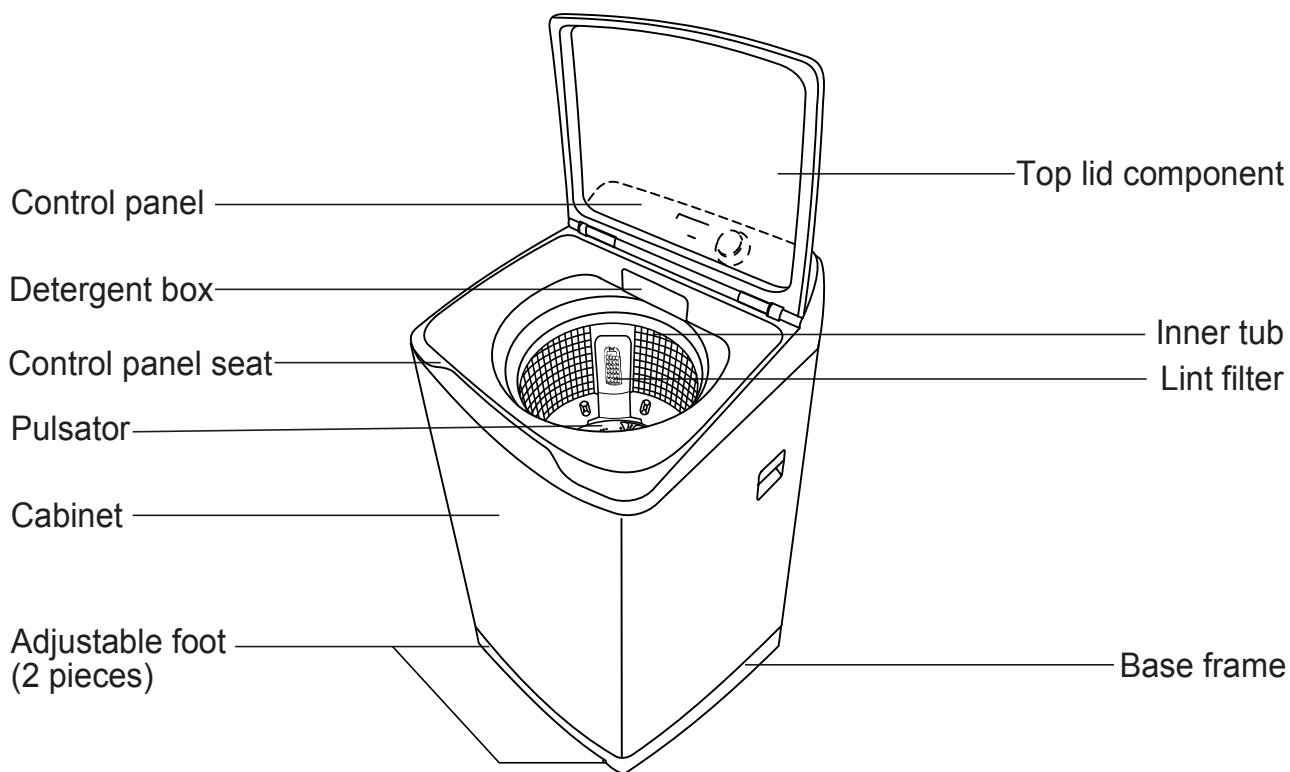

# Product overview



Please understand that the shapes of the washing machine and accessories may be different from the sketch figures in this manual due to product improvement.

# Safety precautions





## Description of symbols

<p><b>Warning sign</b></p> 	<p>Contents marked with this symbol are related to the safe use of the product and the personal safety of the user.</p> <p>Please operate in accordance to the contents of this manual, to avoid harm to the user or damage to the machine itself.</p>
<p><b>Forbidden sign</b></p> 	<p>Contents marked with this symbol indicate operations or actions that should not be undertaken by the user.</p> <p>Performing of such actions may result in an injury to the user or damage to the machine itself, and void warranty.</p>

## Safety warning









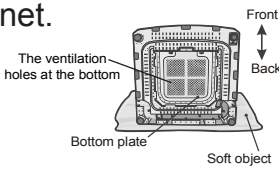

Please check power socket condition to ensure it has been earthed correctly prior to installation to ensure your safety.

### Warning

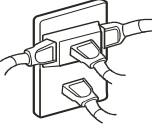
<p>A separate, earthed power socket is required for the power supply.</p> <p>Hold the plug-NOT the electric cable-when unplugging the washing machine.</p> <p>Do not insert or remove the power plug with wet hands.</p> <p>The power plug should be accessible after the machine installation.</p> 	<p>Ensure the plug is removed and the tap is turned off in the following cases: power failure, cleaning, moving, installation and when not in use.</p> <p>The new hose-sets supplied with the appliance are to be used and that old hose-sets should not be reused.</p> <p>The rated washing capacity, spinning capacity, the max. and min. inlet water pressure refer to specification page.</p> 
<p>This appliance is intended to be used in household and similar applications such as:</p> <ul style="list-style-type: none"> <li>— staff kitchen areas in shops, office and other working environments;</li> <li>— farm houses;</li> <li>— by clients in hotels, motels and other residential type environments;</li> <li>— bed and breakfast type environments;</li> <li>— areas for communal use in blocks of flats or in launderettes.</li> </ul> 	<p>If the supply cord is damaged, it must be replaced by the manufacturer, its service agent or similar qualified persons in order to avoid a hazard.</p>  <p>CAUTION: If this appliance is supplied from a cord extension set or electrical portable outlet device, the cord extension set or electrical portable outlet device must be positioned so that it is not subject to splashing or ingress of moisture.</p> 

# Safety precautions

## Forbidden

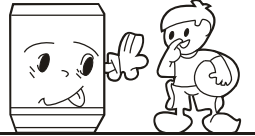
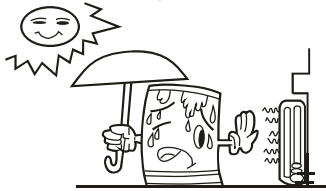
<p>Do not install this appliance in a damp or wet environment. Do not leave wet laundry on the control panel or spray water directly onto this appliance, as this may cause malfunction of the washer or an electrical fault.</p>		<p>Do not connect to hot water hotter than 50°C. The maximum inlet water pressure refers to specification page.</p>	
<p>Do not block the ventilation holes with carpet. Ensure carpet does not obstruct the opening under the base of the cabinet.</p>		<p>Do not wash water-proof clothing as this may affect load balance during spin cycle(s).</p>	
<p>If you are using an extension cord or a portable electrical outlet device (not recommended), ensure that it is positioned so that it does not come into contact with water or moisture.</p>			
<p>Do not attempt to move washing or place hands inside washing machine while in operation. Please ensure children are supervised around machine to avoid harm.</p>		<p>Do not take apart, repair or alter the machine by yourself.</p>	
<p>Do not leave hot or heavy items on lid or control panel as this may cause damage to the washer or make the washer unsafe to operate.</p>		<p>Do not wash laundry with chemicals or other volatile materials (such as petrol, solvents or thinners) as this cause damage to the machine.</p>	
<p>This appliance is not intended for use by persons (including children) with reduced physical, sensory or mental capabilities, or lack of experience and knowledge, unless they have been given supervision or instruction by a person responsible for their safety. Children should be supervised to ensure that they do not play with the appliance.</p>		<p>Keep washer away from heat sources such as heater, stoves or direct sunlight.</p>	

# Safety precautions

## Safety warning

The washing machine whose lid can be opened during water extraction, that it takes 15s or more for complete stop of water-extracting chamber tub.

The new hose-sets supplied with the appliance are to be used and that old hose-sets should not be reused

Please remove item such as coins, button, sand and other solid materials from clothing before washing.



Check that water faucets are open after connection to machine, prior to operation and that pipes are connected correctly.  
Please use low suds/high efficiency washing powder.

■ If power cord or other parts of this machine become damaged or faulty, please contact a technician to have it repaired. Do not attempt to repair by yourself as this may cause personal harm or void warranty.

■ Smart hinge prevents sudden closing of the door. Door is heavy, be careful while closing of the door.

Do not let your hands or any other material be caught below door. It might cause injury or damage.

Door closing time is dependent on ambient temperature.

The higher the ambient temperature is, the shorter the door closing time is and vice versa. Smart Closing Door performs best when lid is closed from full open condition.

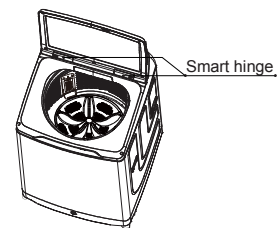

■ The washing machine whose lid can be opened during water extraction, that it takes 15s or more to stop of water-extracting chamber tub. The new hose-sets supplied with the appliance are to be used and that old hose-sets should not be reused.

# Installation & Adjustment

Please install and adjust the machine according to the directions contained in this manual. It is very important to follow these directions for the safe operation of the machine and to ensure your machine operates correctly.

## Install the bottom plate

The purpose of the bottom plate is to suppress noise from the washing machine during operation.

Steps:

1. Lay the washer on its back, on a nonabrasive surface.
2. Place the plate onto the bottom of the machine.
3. Use a screwdriver to tighten the screw (in accessory bag) securing the panel to bottom of the washer.
4. Once the screw is tight and the panel is secure, return the washer to its standing position.

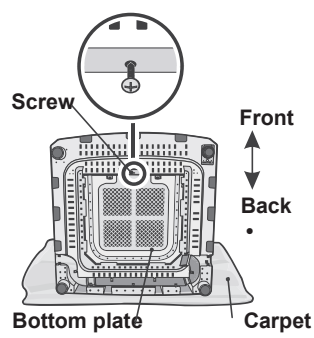

## Balance washing machine

Do not install this machine on an incline greater than  $2^\circ$ . Installing machine on an angle or on rough ground will result in unstable running or stoppage of the machine. Please adjust it by the following method:

1. Confirm it is level.
2. Lift up the side of the leg slightly and twist the adjustable foot.

Note: The distance between the washing machine and wall: at least 20 mm.

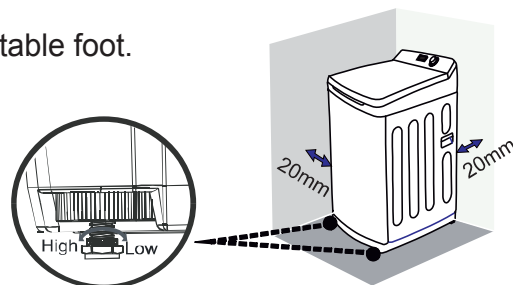
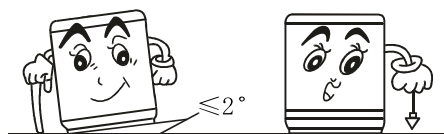

## Change the direction of the drain hose

Place the washing machine on the laying cloth, take out the drainage pipe along the groove the bottom of the washing machine and then embed it in the opposite direction.

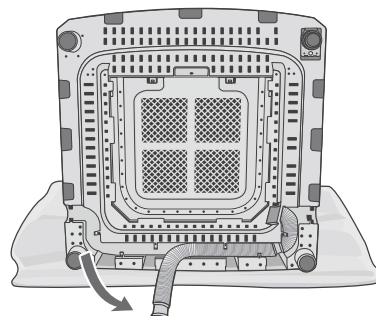

# Installation & Adjustment

## Usage of the drain hose

The drainage shall be smooth with the drain hose.

1. The height of the drain hose shall be less than 10cm, or the drainage will not be smooth, and cost such long time that the machine may stop at mid way.

2. Do not trample or press the drain hose.

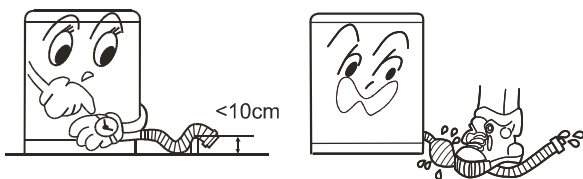

3. If the drain hose is too long, cut it at mid point. To make smooth drainage, cut the front end of the hose slantingly.



4. If extra drain hose is needed, please make separate purchase. The inner diameter of the extra hose shall not be less than 30mm, and the length shall not exceed 1.5m.

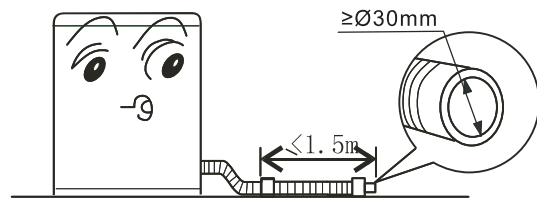

5. If the extra hose is too long, cut it either at A or at B point.

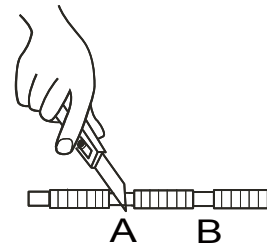

**Note:** The instructions for appliances connected to the water mains by detachable hose-sets shall state that the new hose-sets supplied with the appliance are to be used and that old hose-sets should not be reused.

## Inlet pipe connection

The new hose-sets supplied with the appliance are to be used and that old hose-sets should not be reused.

### Confirm the water faucet

water faucet, suitable

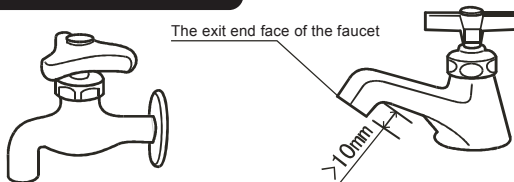

water faucet, not suitable

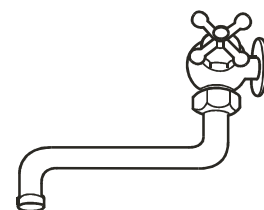

It is required that the front end shall be longer than 10mm.

The exit end face of the faucet shall be flat and smooth. If not, please file it to avoid leakage.



# Installation & Adjustment

## ■ Connection between the water inlet hose jointer and the water faucet

1. Press the lower end of the lock lever and push down the slider. Take off the water inlet hose jointer from the water inlet hose component. See to Figure 1.
2. Take off the nameplate. Make sure the threading is 4mm above the upper surface of the nut. See to Figure 6. If the threading is less than 4mm above the upper surface of the nut, please loosen the screws.

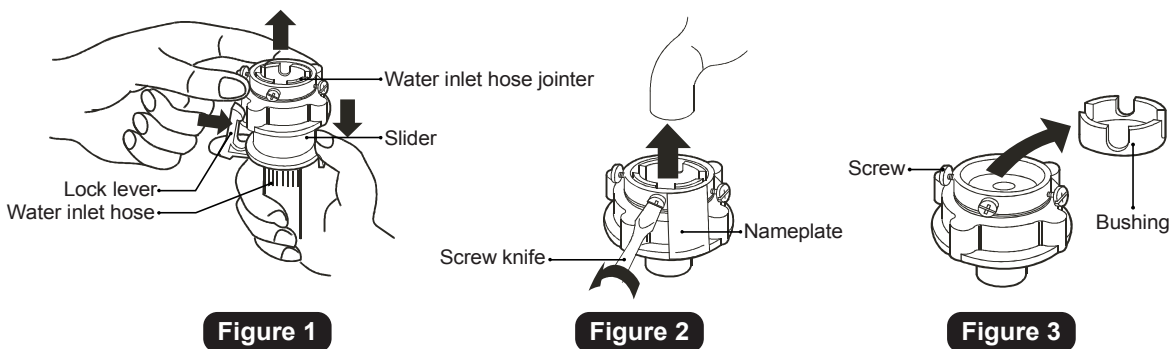

3. Loosen the screw till the water faucet can be accessed. Put the jointer of the water inlet hose on the faucet. See to Figure 2. (If the faucet is too large and the jointer can not be set on the water faucet, please loosen the four screws and take out the bushing in the jointer. The front end of the faucet must be smooth, otherwise it may leak water. See to Figure 3.)
4. Fasten the four screws evenly. See to Figure 4.
5. Twist the fastening nut, see to Figure 5. After installation, the threading is less than 2mm above the upper surface of the nut. See to Figure 6.

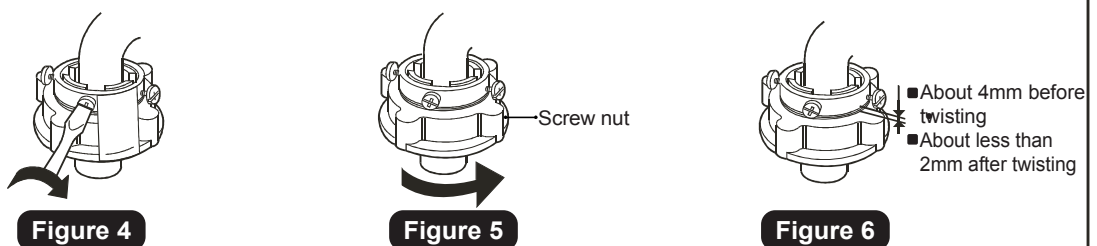

## ■ Connection between the water inlet hose and the washer

1. Do not take off the water absorption cushion. Please check if the cushion is dropped or damaged before each usage. If it happens please contact our after-sale department immediately.
2. Put the nut of the water inlet hose on the valve jointer.
3. Fasten the nut. Swing it gently to confirm if it's suitable.

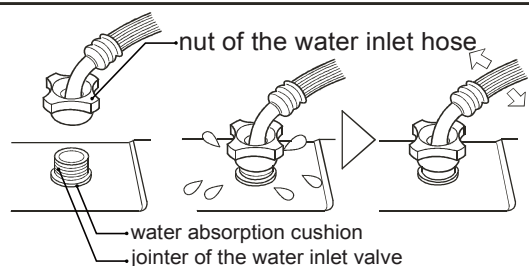

# Installation & Adjustment

## ■ Connection between the jointer of the water inlet hose and the water inlet hose

1. Push down the slider. Insert the water inlet hose into the jointer.
2. Hang the lock lever to the jointer. Release the slider till a click sound is heard.

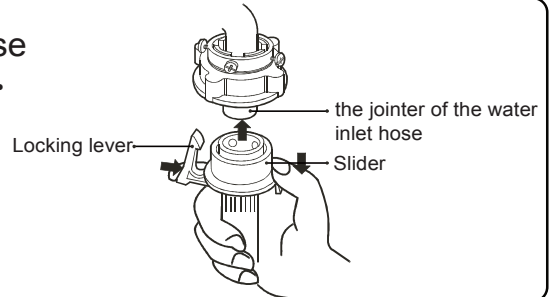

## ■ Check the connection between the jointer of the water inlet hose and the water faucet

1. Swing the hose gently to confirm if it is fastened stably.
2. After installation, open the faucet to check if it leaks.
3. Do not bend the hose with overstrain.
4. Before each usage please check if the connection between the jointer of the water inlet hose and the water faucet, and the installation of the water inlet hose are firm, so as to prevent dropping from improper installation position.

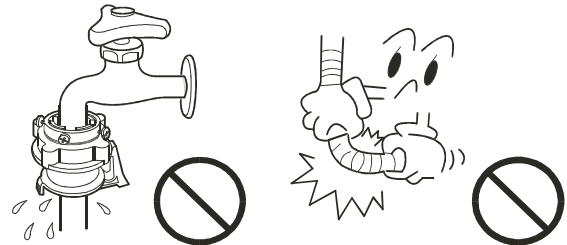

## ■ Dismantle the water inlet hose

1. Close the water faucet.
2. Press the locking lever. Push down the slider. Then pull off the water inlet hose. If the machine is used frequently, the jointer of the water inlet hose will be damaged. If the machine is used frequently, the jointer of the water inlet hose will be damaged.

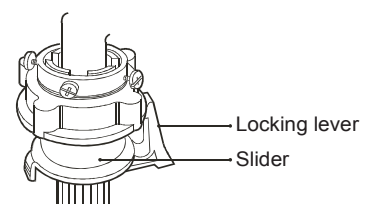

# Before washing



## Preparation before washing

1. Connect the water inlet hose. Open the water faucet.
2. Confirm that the washing machine is earthed reliably. Then insert the power plug into the receptacle. The earth terminal shall not link to gas pipeline and faucet water pipeline.
3. Put down the drain hose.

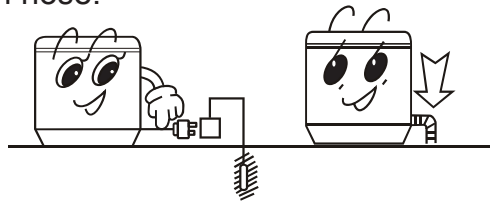

## Check the following before washing

Clear the pockets and take out loose items such as coins, sand, hairpins, etc.



Tie any long straps or strings, fasten buttons and close zippers.



The weight of the laundry shall not exceed the rated capacity of your machine, loosen the laundry before placing it evenly in the tub.

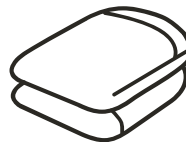

When the machine is running, buttons may cause noise.

To reduce the noise, turn clothes inside out or place them in a laundry bag.

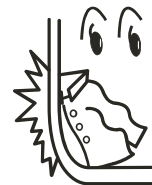

- a. Check if the laundry has any special washing instructions.
- b. Divide the laundry into colourfast and non-colour fast items.
- c. Separate items that do not absorb water easily and wash by hand.
- d. For heavily soiled items, please first remove loose dirt, then apply detergent directly (as per instructions on pack) to the stain before washing.
- e. For those items that may attract lint or are furry or fluffy, please turn inside out before washing.
- f. Do not put laundry soiled with chemicals or solvents into the washing machine.

# Operation

## Loading your laundry

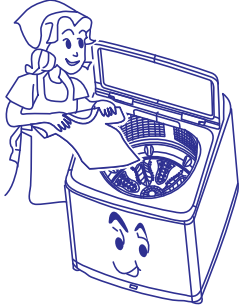

- The rated washing capacity refers to the largest dry weight of a load that can be washed.
- The thickness, size and type of clothes will influence the actual capacity.
- Do not select more than water level “low” for clothes less than 1.0kg, to avoid splashing of water.
- It is recommended that low suds/high efficiency washing powder should be used.

## Usage of the detergent

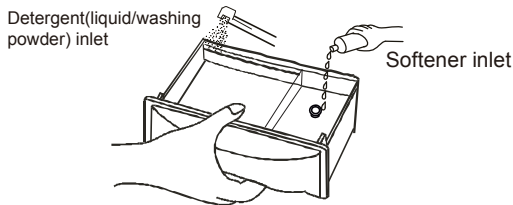

### How to use liquid detergent

Before washing put the liquid detergent into the liquid detergent box directly by following the volume indication on the liquid detergent package.

### How to use softener

- The usage and dose of the softener as per the specifications of softener.
- Before washing put the softener into the detergent box directly. See the above figure. The softener will put into the washer when the last rinsing.
- After the softener is put in, please don't place for a long time otherwise softener may solidify and cause flowing not smooth.
- When water pressure is too low, it is possible that softener cannot be washed away effectively, and softener would be agglomerated after a period of time. Please clean the softener box in time. It is recommended to pour the softener into the basket directly after water is filled at the last rinse.

### How to use washing powder

- It is suggested to dissolve detergent before adding to the tub, see as below: It is suggested
  - 1.Prepare warm water (<35°C) in a container.
  - 2.Add washing powder, stirring to dissolve it completely.
- Adding washing powder in Cotton Wash program  
It is recommended that washing powder/liquid is dissolved with water and then directly emptied into the washing machine:
  - 1.Add some water (select the “low” water level)
  - 2.Add washing powder/liquid. Run for about 30 seconds to fully dissolve the detergent. Then press the “Start/Pause” button to pause the wash cycle.
  - 3.Load laundry. Select suitable water level. Press the “Start/Pause” button again to recommence washing cycle.
- If you select “Express” program, it is recommended to use liquid detergent instead of washing powder to ensure the most effective wash results.
- Old or poor quality washing powder may causing caking in tub or detergent dispenser.
- Clean the detergent box periodically to ensure washing power is evenly distributed and remove any detergent build up.
- When water pressure is too low, it is possible that washing powder or washing liquid cannot be washed away effectively, and washing powder or washing liquid would be agglomerated after a period of time. Please clean the detergent box in time. It is recommended to pour the washing powder or liquid into the basket directly.

# Operation

## Explanation of buttons

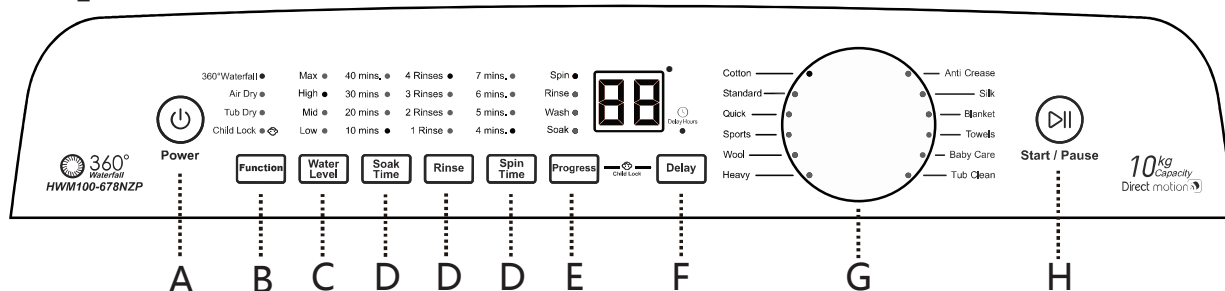

### Indicator display

- Off
- On: Indicates the program is about to run and indicates the selected cycle and options
- :●: Flashing: Indicates the program is running and indicates the selected cycle and options

### Remaining time display

- Displays total time remaining during wash cycle
- Displays remaining time when the "Delay" program is used (hours)
- Displays error codes (see page 16)

### G "Cycle" knob

Program	Recommend
Cotton	Washing Cotton laundries
Standard	The cycle of energy saving for common laundries
Quick	Express wash suitable for a small amount of slightly polluted clothes
Sports	Washing Sports clothes
Wool	Machine washable woollen items
Heavy	Heavy Washing
Anti Crease	Washing t-shirts, shirts laundries
Silk	Delicate items that are machine washable
Blanket	Washing Blanket
Towels	Washing Towels
Baby Care	Washing baby's clothes
Tub Clean	Cleaning the inner and outer tub to avoid the growth of mildew

### A "POWER" button

- To turn on/off the power, press the power button.
- If the start/Pause button is not pressed within 10 minutes, the washing machine will automatically switch off the power

# Operation

## B “Function” button

### ■ Child Lock

The function is intended for children safety and preventing the washing program from accidental changes by children.

Set the desired washing program, after setting, press the Start/Pause Button, and washing machine begin to run. Then press the Progress Button and Delay Button at the same time for more than 3 seconds, you will hear three beep sounds, digital tube display “CL”, and the Child lock will activate. All of the Buttons are locked, and can not be operated.

Release the Child Lock function:

After the washing machine starts, Press the Progress Button and Delay Button at the same time for more than 3 seconds, after three beep sounds, the Child Lock function is released.

Note: If you open the lid when the Child Lock activate, digital tube display “E2”, and beep, you need close the lid and press the Start/Pause to cancel, or washing machine will drain after 10 seconds, and power off after 10 minutes.

### ■ Tub Dry

Press the " function " button to select the tub dry procedure. The purpose is dry the outer tub and the inner tub , which can avoid growing mildew on the outer tub and the inner tub.

### ■ Air Dry

Press the " function " button to select the air dry procedure. The purpose is dry laundries. The max drying capacity of the fibre laundries is 2.5kg.

"Air Dry" program can not be reserved

### ■ 360° Waterfall

Push the “360° Waterfall” button to select the special current. The purpose is mixture the laundries and detergent. “360° Waterfall” program can not be selected at Towels, Tub clean, Anti-Crease and Quick procedure. “360° Waterfall” program can be function at Low, Mid or High water level While other procedure.

.

## C “Water Level” button

- To change the water level, press the Start/Pause button and make your selection by pressing the “Water Level” button until desired level is shown.
- If there is water inside the tub and the machine cannot detect the laundry load, it will display water level “Mid”. If wet laundry is put in the machine, it will display level “Mid”, you can then manually adjust to the desired water level.
- If Quick program is selected it will display water level “Low” you can then manually adjust to the desired water level.
- If Tub Clean program is selected the water level cannot be manually overridden.
- The water level may vary due to the different moisture level of the laundry items.

# Operation

## D “Soak Time” “Rinse” “Spin Time”

- Each program can change the Soak Time, Rinse, Spin Time except Anti Crease, Blanket and Tub Clean. Quick and Wool programs can not change the Soak Time. Tub Clean program can not change these parameters.

## E “Progress” button

- You may change the Progress when Cotton, Standard, Sports, Heavy, Silk, Towels, and Baby Care cycles are selected.
- You may not change the Progress when Quick, Tub Clean, Wool, Heavy, Anti Crase, and Blanket cycles are selected.

## F “Delay” button

- The display shows the time remaining (in hours) before the cycle finish.
- press the "Delay" button and the display will show the remaining time for the cycle to finish (in hours). The indicator flashes to indicate that the delay function is operating.
- Delay start can be set for 2-24hr operation.
- **NOTE:** The delay time is until the selected wash program finishes (you need to deduct wash time from this delay time to calculate when the wash start).

## H “START/PAUSE” button

After the power is switched on press the “Start/Pause” button to start the machine.

- During operation, press the Start/Pause button to pause the machine.
- press the Start/Pause button again to restart the machine.

## Button Operation and Descriptions

**1** Press the “” button to switch power on/off

**2** Turn the “Cycle” knob to select automatic program

When the power is switched on, “Cotton” cycle is automatically set. Turn the “Cycle” knob to select automatic program.

Eg. Choose “Quick” cycle for a small load of lightly soiled laundry. When the “Cotton” or “Standard” cycles are selected, the Fuzzy Logic program is run. The washing cycle is automatically set while the water level and wash time can be selected according to the texture and size of the load.

# Operation

## 3 Press the “ ” buttons to customise the pre-set options

- Separate colour fast clothes before loading washing machine.
- During Rinse cycle, only Spin time can be set, all other wash functions are locked.
- During Tub Clean cycles, these settings cannot be changed and buttons will not function, as machine will only follow pre-programmed settings.

## 4 Press the “” button to change the water level

- For the "Cotton" and "Standard" cycles the machine will run a Fuzzy Logic program that automatically detects the type of laundry in the tub. After detection it will set the water level automatically.
- The water level can be changed the machine has started by pushing the "Start/Pause" button, then push the "Water Level" button to reset the water level. Press the "Start/Pause" button to resume the wash cycle.

## 5 Press the “” button to select the delay wash program

The delay time program is automatically off, and wash cycles will start as soon as “Start/Pause” button is pressed.

### Confirm the operation of “Delay” program

- To set a delay time, first select the Cycle and options required and press the “Delay” button.
- The cycle indicator lights will go off and the "Delay" (Hours) indicator light will be on.
- During the delay program, press the "Delay" button to display the time remaining. The delay time indicator shows the time remaining till the wash ends.
- To cancel the delay program, switch the power off and back on, then make a new selection.
- Delay start (2-24hr) option.
- Delay time is to the end of washing cycle.



The wash will finish  
in about 18 hours

## 6 Press the “” button to start the cycle

Start / Pause

## Cycle completed

- When the machine has completed the selected/current wash cycle an audible alarm will sound and the machine will switch off automatically.



# Cleaning or Maintenance

## Maintenance

- Remove the power plug before carrying out any cleaning or maintenance.
- Clean the lint filter(s) and detergent box after each wash, otherwise it may influence you using the machine.

Clean the detergent box and set it on the control panel seat.

1. The method of dismantling: push it out gently.
2. The method of cleaning: use a brush, duster cloth to clean it, then flush it with water.
3. The method of installing: install it gently and push it in.



Remove

Install

The filter at the water inlet valve may become blocked by impurities in the water supply. Clean it with a plastic bristled brush every two months.

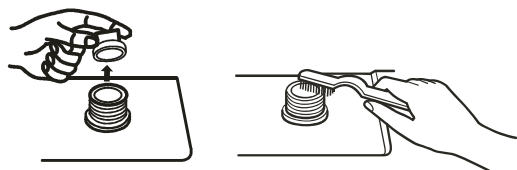

- The lint filter must be used during washing.
- It must be cleaned in time after each using.

The methods of dismantle and install lint filter as follows:

1. Press the spring piece of the top lint filter to make the claws out of the filter cover, and then pull out the lint filter to get it down.
2. Pull the back of the lint filter, and then you can get it from the front cover of the lint filter.
3. Sweep the lint from the lint filter.
4. Put the back of the lint filter into the front cover.
5. Put the lint filter into filter cover, and make it tight.
6. Make sure the lint filter well installed, or it can influence your use.

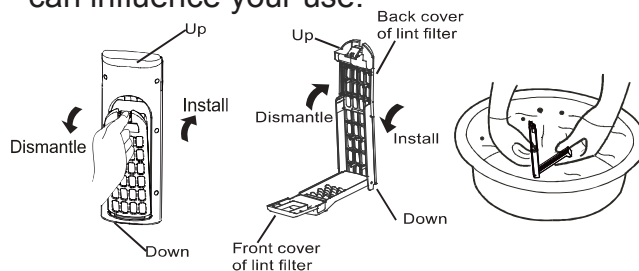

If the cabinet is dirty, wipe it with a damp cloth

- Do not wash directly with water.
- Wipe with a neutral detergent (please check directions on detergent bottle first).
- Do not wipe machine with thinners, petrol, alcohol or other harsh solvents.

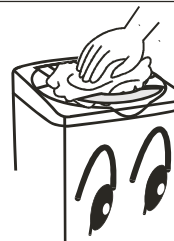

1. After washing cycle has finished, turn off the water faucet. (If needed, you can remove the water inlet hose).
2. Do not store water in the washing machine for a long period without completing a wash cycle. Drain the water completely after each wash.
3. Hang up the power cord and drain hose.
4. Wipe off any drops of water on the surface of the machine and inside the tub. Leave the lid open for about 1 hour after each wash to evaporate any residual water.

# Trouble-shooting

If there is a fault or the machine does not operate correctly, remove the power plug before checking the machine. Using diagnostic list below, please check if the machine requires repair. If a repair is required, please contact our customer care team, do not try to fix it by yourself.

Problem		Possible causes	What to do
The machine does not drain or drain slowly. The display shows E1.		<ul style="list-style-type: none"> <li>■ Is the drain hose blocked?</li> </ul>	<ul style="list-style-type: none"> <li>■ Remove the blockage. Press Start/Pause button once more.</li> </ul>
The machine stops running The display shows E2.		<ul style="list-style-type: none"> <li>■ The top lid is not closed.</li> </ul>	<ul style="list-style-type: none"> <li>■ Close the top lid. Press the Start/Pause button once more.</li> </ul>
The machine does not spin The display shows E3.		<ul style="list-style-type: none"> <li>■ Has the laundry been placed unevenly in the machine?</li> <li>■ Is the machine level?</li> </ul>	<ul style="list-style-type: none"> <li>■ Redistribute the load evenly. Press the Start/Pause button once more.</li> <li>■ Level the machine.</li> </ul>
The display shows E4.		<ul style="list-style-type: none"> <li>■ Is the water tap closed or has the water supply been interrupted?</li> <li>■ Is the water inlet valve blocked?</li> <li>■ Is the water pressure too low?</li> </ul>	<ul style="list-style-type: none"> <li>■ Turn on the water tap. Press Start/Pause button once more.</li> <li>■ Clean the water inlet valve then press the Start/Pause button once more.</li> <li>■ Use after the water pressure is normal.</li> </ul>
The display shows FA.		<ul style="list-style-type: none"> <li>■ The water level sensor has failed.</li> </ul>	<ul style="list-style-type: none"> <li>■ Please contact Customer Care.</li> </ul>
The machine does not work.	Will not wash	<ul style="list-style-type: none"> <li>■ Is there a power failure?</li> <li>■ Is the power plug inserted tightly?</li> <li>■ Has the water level reached preset position?</li> </ul>	<ul style="list-style-type: none"> <li>■ Wait for the power supply to be restored.</li> <li>■ Insert the power plug tightly.</li> <li>■ Wait for the water to fill to the preset level</li> </ul>
	Will not spin	<ul style="list-style-type: none"> <li>■ Is the power plug inserted tightly?</li> <li>■ Is the top lid closed?</li> <li>■ Is the laundry distributed unevenly in the machine?</li> </ul>	<ul style="list-style-type: none"> <li>■ Insert the power plug tightly.</li> <li>■ Close the top lid. Press the Start/Pause button once more.</li> <li>■ Redistribute the laundry.</li> </ul>
There are abnormal sounds inside the machine.		<ul style="list-style-type: none"> <li>■ Is the machine level?</li> <li>■ Has the laundry been placed unevenly in the machine?</li> <li>■ Are there any foreign objects inside the bowl?</li> </ul>	<ul style="list-style-type: none"> <li>■ Level the machine.</li> <li>■ Redistribute the load evenly. Close the top lid. Press the Start/Pause button once more.</li> <li>■ Remove the foreign objects.</li> </ul>



# Trouble-shooting

Problem	Possible causes	What to do
The water tap leaks.	■ Is the water inlet hose loose?	■ Fasten the inlet hose.
The display shows E8.	■ Is the door lock broken?	■ Please contact Customer Care.
The display shows E9.	■ Communication failure between display board and power board.	■ Please contact Customer Care.
The display shows F2.	■ Indicates water has reached a critical level.	■ Please contact Customer Care.
The display shows FC.	■ Communication failure between display board and motor driver.	■ Please contact Customer Care.

## Common occurrence

Situation	Cause
■ The spinning is intermittent after it starts.	■ Redistribute the load evenly. Close the top lid.
■ Select spin program, but it does not work.	■ The program is setting the drain time, there will be a pause before the spin program starts.
■ There maybe water in the drain hose when first used.	■ It may be residual water after performance inspection by the factory.
■ The wash procedure pauses.	■ The cloth sensor is detecting, it will add water after about 48 seconds.

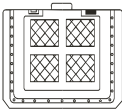
# Packing list

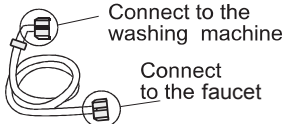
Name	Quantity	Storage position
■ Automatic washing machine	■ One	
■ Bottom plate 	■ One	■ Placed in the upper foam piece inside the washing machine packaging
■ User manual	■ One	■ Inside the document bag
■ Warranty card	■ One	■ Inside the document bag
■ Screw 	■ One	■ Inside accessory bag
■ Components of the water inlet hose 	■ One	■ Inside accessory bag

# Specification

Model	HWM100-678NZZ
Rated voltage · frequency	220V~/50Hz
Water level/Water quantity (L)	Low-43 Mid-57 High-71 Max-84
Inlet pressure (MPa)	0.03-1.0
Dimensions (mm)	L-580 W-590 H-1010