



Advancing the science of washing

SENATOR 6kg
· · aqua-energie · ·

OPERATING MANUAL

USE ONLY GENUINE IFB SPARES & ACCESSORIES

** Company shall not be responsible for defects arising due to usage of spurious parts and accessories*

Dear Customer

A warm welcome to the international family of IFB 'tumble wash' technology based washing machine owners.

Your washing machine, is truly going to be your freedom machine. It requires just 30 seconds of your time in loading the fabrics and setting the programme.

Thereafter, you are totally free to do what you please. This washing machine does not need your supervision anymore. This washing machine is modelled on the unique 'tumble wash' concept for superior fabric care and wash performances.

As you read this manual you will understand what this washing machine can do for you.

For any further information, please contact your nearest dealer or IFB's Service Centre.



Chief Executive

CONTENTS

KNOW YOUR MACHINE	5
INSTALLATION	7
<input type="checkbox"/> Pre Installation	
<input type="checkbox"/> Unpacking	
<input type="checkbox"/> Setting Up	
<input type="checkbox"/> Water Inlet	
<input type="checkbox"/> Water Outlet	
<input type="checkbox"/> Electrical Connection	
USING YOUR MACHINE	9
<input type="checkbox"/> Control Panel	
<input type="checkbox"/> Automatic Detergent Dispenser Tray	
<input type="checkbox"/> Selector Buttons	
<input type="checkbox"/> Spin speed selector knob	
<input type="checkbox"/> Temperature Selector Knob	
<input type="checkbox"/> Programme Selector Knob	
<input type="checkbox"/> Indicator Lamp	
<input type="checkbox"/> Kinds of Wash Programmes	
<input type="checkbox"/> Programme Selection	
<input type="checkbox"/> Programme Selection Chart	
OPERATION	19
<input type="checkbox"/> Sorting of Garments	
<input type="checkbox"/> Loading the Machine	
<input type="checkbox"/> Detergent to be used and Quantity	
<input type="checkbox"/> Fabric Conditioner	
<input type="checkbox"/> Treatment of Stains	
<input type="checkbox"/> Wash Load Guide and Capacity	
<input type="checkbox"/> International Washing Symbols	
<input type="checkbox"/> Programme Run	
<input type="checkbox"/> Switching Off the Machine	
<input type="checkbox"/> Check Points	
MAINTENANCE	24
<input type="checkbox"/> Coin Trap	
<input type="checkbox"/> Drum	
<input type="checkbox"/> Sieves	
<input type="checkbox"/> Frost Protection	
<input type="checkbox"/> Draining During Emergencies	
FAULT DIAGNOSIS	26
<input type="checkbox"/> Why does it happen?	
SAFETY PRECAUTIONS	27
TECHNICAL DATA	29

KNOW YOUR MACHINE

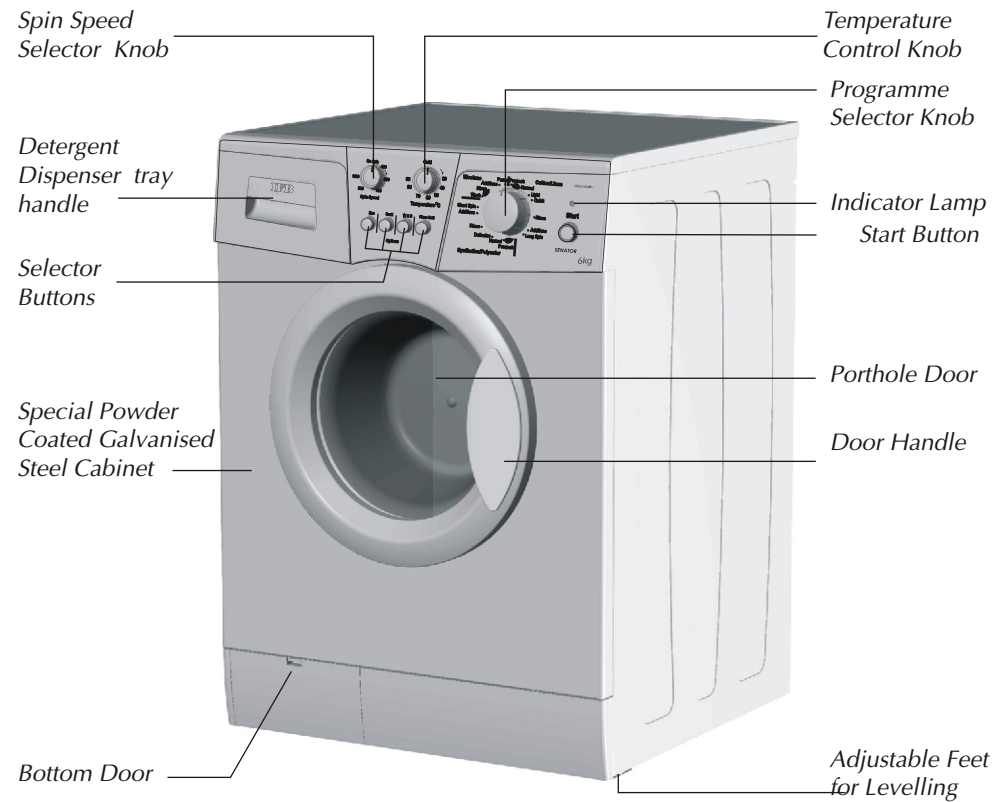

ADVANTAGES OF TUMBLE WASH

- ❑ MOST EFFECTIVE CLEANING AS THE CLOTHES PASS THROUGH SOAPY WATER AND ALSO FALL ON SOAP SOLUTION IMPROVING WETTING OF CLOTHES.
- ❑ RESEMBLES THE THUMPING AND RUBBING ACTION OF GENTLE HAND WASH.
- ❑ USES LESS WATER COMPARED TO TUB TYPE TOP LOADERS.
- ❑ LESS WATER MEANS LESS DETERGENT AND ELECTRICITY CONSUMPTION.
- ❑ WASHING IS EFFECTIVE BY DETERGENCY, SOAKING, HEATING, TUMBLING AND SQUEEZING.
- ❑ GIVES BETTER DRYING EFFECT BY SPINNING.

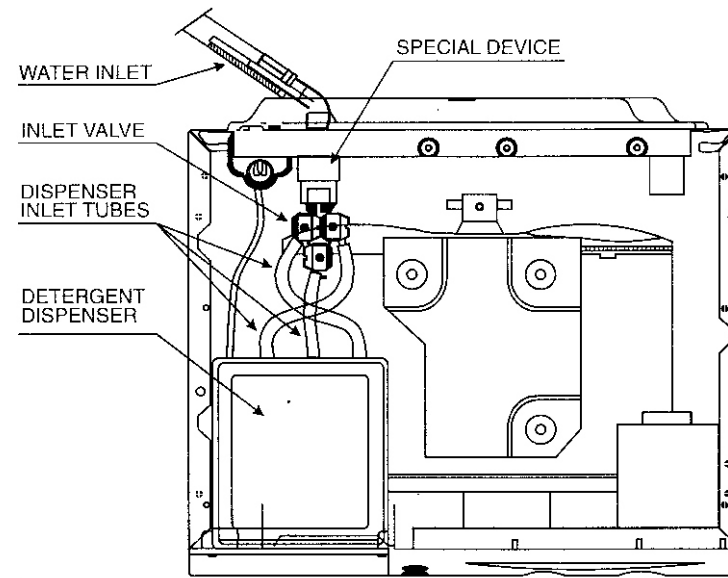

AQUA ENERGIE

AQUA ENERGIE series machine deploys a specialized physical treatment device to improve the quality of water. The effect is more visible in hard waters areas.

The special device is a part of the water in take system.

It breaks the bi-carbonates in water into microscopic crystals and reduces tendency of the crystals to stick to any surface.

This in turn makes the crystals flow with water and improves the power of detergents solution. The reduced surface tension of the treated water facilitates wetting of clothes and improves detergents action.

ADVANTAGES* OF AQUA ENERGIE.

Reduced scaling on components such as Heater & Tub.

Reduction in detergent consumption.

Reduction in detergent traces in washed clothes.

Improvement in wash quality.

*Depend on hardness of water supplied to the machine.

INSTALLATION

PRE-INSTALLATION

1. Make sure there is a 16 amp. 3-pin electrical point preferably with a 16 amp. fuse, within 1 meter of the machine. Make sure it has proper earthing.
2. Fixed plumbing is recommended for the machine. The water inlet of the machine has a collar with 3/4" parallel internal threads. The water supply point with an external 3/4" parallel thread should be available within 1 meter of the machine's location.
3. Two options on the water inlet and drain pipe connection are shown. In case these possibilities do not exist for the drain pipe, please arrange an additional length of pipe.
4. Please inform our service centre for installation and demonstration of the machine once the points mentioned above have been completed.

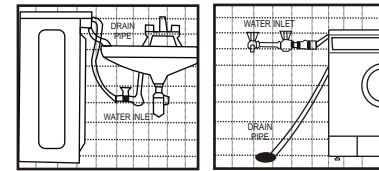
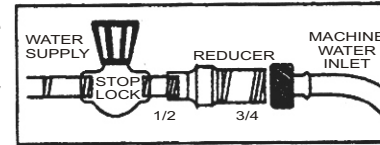

UNPACKING

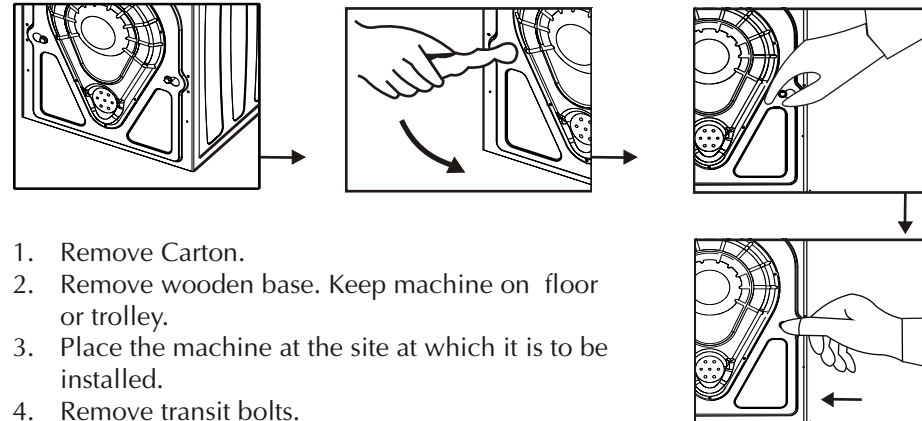

1. Remove Carton.
2. Remove wooden base. Keep machine on floor or trolley.
3. Place the machine at the site at which it is to be installed.
4. Remove transit bolts.
5. Insert plastic caps provided into holes vacated and press till they click into place.
6. Keep transit bolts carefully. They will be required in case you need to shift the machine again.
7. For shifting and re-installation at a new site, please get in touch with our service personnel.
8. Keep packaging material carefully. It comes handy while shifting residence.
9. PLEASE DO NOT OPERATE THE MACHINE TILL TRANSIT BOLTS HAVE BEEN REMOVED.

SETTING UP

1. MAKE SURE THAT THE MACHINE RESTS ON ALL FOUR FEET ON A LEVEL SURFACE. Adjustable screws are provided at the bottom to allow levelling.
2. Loosen securing nut. Adjust the screw to change level. Tighten securing nut to ensure that screw is locked into place.
3. MACHINE SHOULD BE LEVELLED AGAIN IN CASE IT IS MOVED TO A NEW SITE.

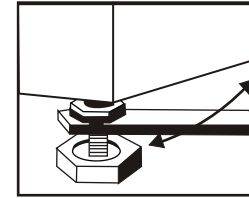

WATER INLET

1. Connect inlet hose to water tap/line.
2. Do not connect machine to a hot water supply.

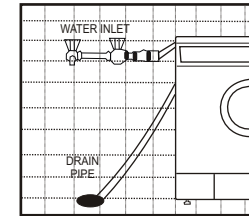

WATER OUTLET

1. A drain pump is provided in the machine to pump out used water.
2. The end of the outlet should be placed near a drain. If necessary, it can be placed over the edge of a sink at a maximum height of 1 mt. from the floor level.
3. Allow free flow of water from the outlet pipe.

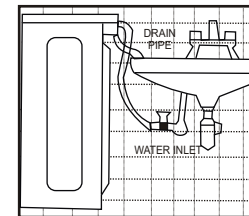

ELECTRICAL CONNECTION

1. Check that the electrical line can take the required load.
2. Connect to a 220V, 50 Hz single phase AC supply.
3. Machine must be earthed properly before operation. This can be done by using a 3 pin plug and properly earthed socket of 16 ampere rating.
4. Ensure that there is a firm connection between the 3 pin plug and socket, else it may result in sparking and subsequent failure of 3 pin plug.
5. Use of extension cord not recommended.

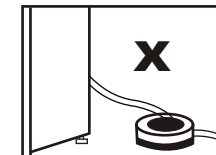
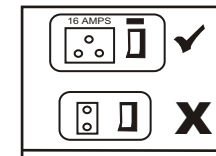

USING YOUR MACHINE

CONTROL PANEL

Let's take a look at the control panel and understand the working of each of its features. Each feature serves a specific purpose in the complete operation of the machine.

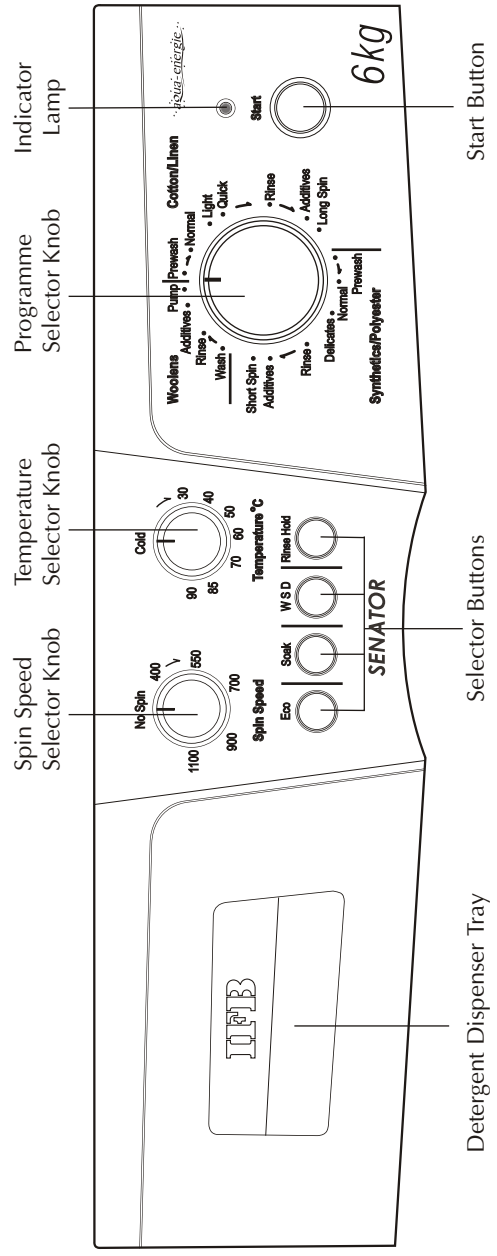

AUTOMATIC DETERGENT DISPENSER TRAY

Designed for automatic dispensing of detergent & additives as required, which avoids manual filling at each stage. The Detergent Dispenser Tray should be filled (with detergent and additives) before the start of a programme. The tray has three chambers.

1. Pre-wash chamber: (Marked-I), to be filled with detergent in case a pre-wash programme has been chosen or heavily soiled clothes are being washed.
2. Main wash chamber: (Marked-II), requires detergent for every wash programme.
3. Fabric conditioner additives chamber: (Marked ) , to be used for additives only. It should be filled as per instructions under "Operation". The detergent tray must be pulled out, filled as required and shut before the machine is switched on.

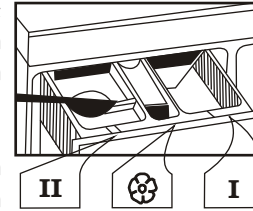

SELECTOR BUTTONS

ECO Button

- This option is for environmental friendly and energy saving operation of washing.
- With Eco button pressed, the mechanical tumbling action during wash is considerably increased in such a way that at lower temperature and power consumption the same quality of wash is achieved as that with high temperature and less mechanical tumbling action. Refer 'Programme Selection chart'
- In cotton Wash Programme the Eco button gives more vigorous wash action when pressed and gentle wash action when released.
- In EASY CARE programme the Eco button gives medium vigorous wash action when pressed and gentle wash action when released.
- This button is not effective in woollen programme.

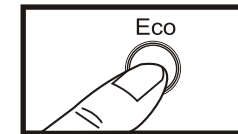

SOAK Button

- ❑ Soaking facilitates action of detergent to dislodge the dust particles from the clothes for the better wash quality.
- ❑ This option is available for cotton & easy care wash programme.
- ❑ If this button is pressed the clothes remain stationary (soaked) in soapy water during main wash cycle for 12 min. in Cotton wash and in Easy care wash programme, after which it continues with its Normal washing cycle.
- ❑ If this button is not pressed the clothes tumble during soaking period.
- ❑ Soaking Action is inbuilt in wool wash programme.



WATER SAVE DEVICE Button (WSD)

"Water Save Device" button provides an option for Reducing 15 -25% of water for Small laundry of medium and less soiled clothes.

- ❑ Do not use this option in the case of Curtains, Bedsheets, & extra delicate fabrics etc..



RINSE HOLD Button

- ❑ Press this button if you do not want to remove the washed clothes immediately after the wash programme is completed.
- ❑ This option when selected will prevent the clothes from creasing by holding them in water before final spin. Just release this button and the wash cycle will continue further.
- ❑ In addition to rinse hold option an Inbuilt Antcrease Action of tumbling takes place after Final spin to reduce creasing.



START BUTTON

- ❑ To switch ON the machine Press this button. Indicator lamp will glow to indicate the machine is powered.
- ❑ To switch OFF the machine release the START BUTTON Indicator lamp will glow OFF.

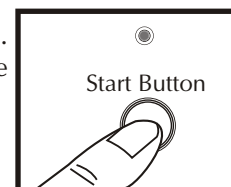

INDICATOR LAMP

- ❑ Red lamp glows when the machine is switched ON and switches OFF when machine is switches OFF.

SPIN SPEED SELECTOR KNOB

- ❑ To select No spin, Turn the knob in Anticlockwise direction to No Spin position. A gentle click will be heard.
- ❑ When selected the machine will not spin during spinning duration.
- ❑ The knob should not be turned beyond No Spin position in anticlockwise direction.
- ❑ Spin speeds between 400 rpm min to 1100 rpm max. can be selected by rotating the knob.
- ❑ The knob should not be turned beyond 1100 rpm marking in clockwise direction.
- ❑ In cotton wash programme 1100 rpm max spin speed can be selected.
- ❑ In easy care programme 700rpm max spin speed can be obtained, even if knob setting is beyond 700 rpm.
- ❑ Spin drying is not available in wool programme.

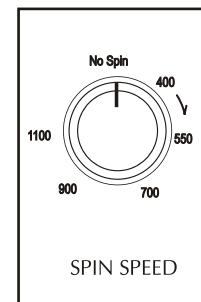

TEMPERATURE SELECTOR KNOB

- ❑ Temperature to be set only if a hot wash is required, otherwise there will be a cold wash in position 'cold'.
- ❑ Temperatures can be selected between 30° C - 90° C depending on fabric type.
- ❑ **KNOB SHOULD NOT BE TURNED BEYOND 90° C IN THE CLOCKWISE DIRECTION.**

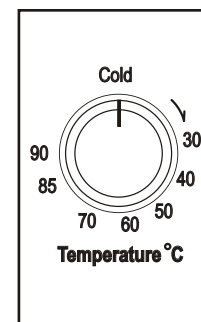

PROGRAMME SELECTOR KNOB

- To select the right programme as per the fabric being washed and extent of soilage.
- A choice of 30 programmes is available to wash different kinds/loads of clothes.
- Programme selection should be done before the machine is switched ON.
- Only one programme can be selected at a time.
- Only the starting point in a programme needs to be selected, thereafter the machine runs through the cycle automatically.
- If for any reason you wish to change the programme after the wash process has begun - just switch OFF the machine - set the desired programme and re-start.
- Knob should be Turned in Clockwise Direction.**
- Programme selection knob should be set only at the position as indicated in the programme selection chart.

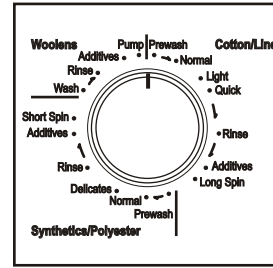

KINDS OF WASH PROGRAMMES

- There are 30 fully automatic programmes to suit different applications. To select a programme, you must understand the three basic groups of wash programmes.
 1. Cotton Wash
 - The washing action is more vigorous / Gentle, for a longer duration, to help clean clothes better.
 - To be used for whites , cottons and coloureds.
 - Not to be used for woollens and delicate fabrics.
 2. Easy Care
 - The washing action is less vigorous / Gentle and for a shorter duration.
 - To be used for easy care fabrics like polyester blends , etc.
 3. Wool Programmes
 - For woollen and soft fabrics only.
 - This programme has a built - in Gentle wash function, irrespective of ECO Button Selection.
 - No Spin drying takes place in this programme.

Symbols on DD TRAY

- I** Pre - Wash
- II** Main Wash
-  Additive

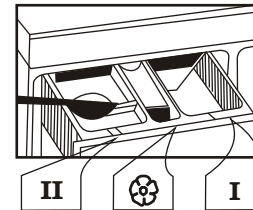

PROGRAMME SELECTION

1. Cotton wash programmes (Linen)

STAGE 1 : Pre - Wash -

- This cycle takes place before the main wash.
- To be used for heavily soiled clothes, which are given a preliminary wash.
- Detergent to be filled in compartment I (extreme right).
- At the end of this pre-wash the dirty water is pumped out automatically.
- IN CASE CLOTHES ARE NOT HEAVILY SOILED, THE "PRE-WASH" CAN BE AVOIDED BY SETTING THE PROGRAMME SELECTOR KNOB TO ANY OF THE MAIN WASH PROGRAMMES AS GIVEN BELOW AND DETERGENT FILLED ONLY IN THE MAIN WASH CHAMBER MARKED II (EXTREME LEFT)

STAGE II: Main Wash - NORMAL / LIGHT / QUICK

- Main wash starts with detergent being drawn from the extreme left compartment of the detergent dispenser tray.
- Clothes are soaked for 12 Minutes if soak button is pressed.
- IF CLOTHES ARE NOT VERY DIRTY, THE MAIN WASH CAN BE STARTED BY DIRECTLY SETTING THE PROGRAMME SELECTOR KNOB AT LIGHT/QUICK TO REDUCE WASHING TIME & ENERGY CONSUMPTION
- Main wash is completed with Intermittent short spins of 700 rpm max.

STAGE III: Rinse

- After washing, the rinsing is done automatically. In the Cotton wash your clothes are rinsed three times.
- For most efficient rinsing intermittent short spins are provided in the rinse programme at 700rpm max.
- Fabric conditioner is drawn from the detergent dispenser tray marked  (middle chamber) during the last rinse (Additives). If no conditioner is added, the machine continues to rinse in ordinary water.
- If rinse hold button is pressed, the clothes will remain floating in water during last rinse till the button is released again in order to continue the further programme.

STAGE IV : Spin Drying: - Long Spin

- Spin drying takes place at 700 r.p.m. and then goes upto 1100 r.p.m.
- Any spin speed between 400 rpm min. to 1100 rpm. Max. can be selected using spin speed selector knob.
- After spinning, the clothes tumble for 6 Minutes to reduce creasing.

2. Easy Care Programme (Synthetics / Polyester)

- For polyester blended fabrics like terrycots etc.

STAGE I : Pre-Wash:

- The cycle takes place before the main wash.
- To be used for heavily soiled delicate clothes.
- At the end of the pre-wash the dirty water is pumped out automatically.
- IN CASE CLOTHES ARE NOT HEAVILY SOILED, THE PRE-WASH CAN BE AVOIDED BY SETTING THE PROGRAMME SELECTOR KNOB TO ANY OF THE MAIN WASH PROGRAMMES AS GIVEN BELOW

STAGE II: Main Wash : NORMAL / DELICATES

- If clothes are very lightly soiled, set the programme selector knob at 'DELICATES' to reduce washing time and energy consumption.
- Clothes are soaked for 12 Minutes if soak button is pressed.
- Main wash is completed with intermittent short spins of 700 rpm max.

STAGE III: Rinse

- After washing, the rinsing is done automatically. In this programme your clothes are rinsed three times.
- For most efficient rinsing intermittent short spins are provided in the rinse programme at 700 rpm max.
- Fabric conditioner is drawn from the detergent dispenser tray marked  (middle chamber) during the last rinse (Additives). If no conditioner is added, the machine continues to rinse in ordinary water.
- If rinse hold button is pressed, the clothes will remain Floating in water during last rinse till the button is pressed again in order to continue the further programme.

STAGE IV: Spin Drying : Short Spin

- Spin speed selector knob to be used for spinning in the range of 400 to 700 rpm.
- Spinning is followed by Antcrease cycle of 3 minutes tumble, during which the clothes are loosened for the convenience of open drying without creasing.

3.The Wool Programme : (Woolen)

STAGE I : Wash

- This programme starts directly with the main wash.
- The programme has a built-in Gentle wash function.
- Detergent to be filled only in the main wash chamber marked II (extreme left).

STAGE II : Rinse

- After washing, your clothes are rinsed three times.
- If rinse hold button is pressed, the clothes will remain floating in the water during last rinse till the button is pressed again in order to continue the further programme.
- No spin drying takes place.
- Machine stops after pumping at 'PUMP'
- Switch OFF the machine after the water is drained out.

Draining : PUMP

This programme is used to drain water out of the machine at any stage if required.

- Switch OFF the machine.
- Re-set the programme selector knob at point 'PUMP'.
- Switch ON the machine.

Exclusive spin drying programme:

- Can be used for spin drying hand washed/wet clothes
- Turn the programme selector knob directly to LONG SPIN / SHORT SPIN position after loading the clothes .
- Select the spin RPM according to the material of the clothes.(eg.cotton-1100 max, synthetic - 700 max.)
- Switch ON the machine.

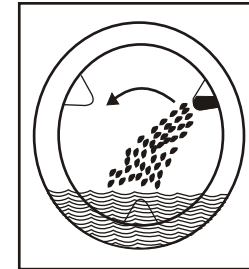

A Unique shower system)

Scoops on the inner drum pick up water and shower through perforated fins on the laundry as the drum rotate. This ensure a thorough wetting of the laundry. What's more, the process requires less water and thus less energy to heat it.

Cool down cycle

Hot water drained after Main wash cycle can be harmful for people and environment .Hot water is cooled down by taking additional cold water automatically, which also reduces concentration of detergent, thus ensures better rinse quality and eco friendly environment.

Note:

IF THE LOAD OR MACHINE IS VERY MUCH UNBALANCED THE MACHINE IN THE PROCESS OF BALANCING/DISTRIBUTING THE LOAD MAY SUDDENLY STOP DURING SPINNING OR MAY SPIN AT VERY LOW RPM IN ORDER TO TAKE CARE OF VIBRATION WHICH MAY OCCUR UNDER SUCH CIRCUMSTANCE.

IN CASE ELECTRICITY WATER SUPPLY GOES OFF, THE MACHINE STOPS AND STARTS AGAIN FROM THE SAME POINT, AUTOMATICALLY, ON RESUMPTION OF ELECTRICITY / WATER SUPPLY.

Recommendations for a mixed load:

For washing a varied mix of clothes i.e. cottons, rayon, polyester, etc. if there is:-

- A predominance of cotton clothes - use the cotton wash programme
- A predominance of polyester/synthetic clothes -use easy care programme
- The washing procedure remains the same.

PROGRAMME SELECTION CHART

- To select the right programme for your wash, a tabulated programme Chart is given on the Detergent Dispenser Drawer to indicate fabric type and wash temperature.
- Additionally, you can refer to the detailed programme Chart given below 30 fully automatic wash programmes available with respect to fabric type, degree of soilage, wash cycle, wash temperature and wash loads.

CAPACITY	PROGRAMME SELECTION CHART			DETERGENT IN CHAMBER		ADDITIONAL BUTTONS				ADDITIONAL FUNCTION	TEMP SELECT MAX°C		TYPE OF WASHING (PLEASE NOTE WASH CARE LABELS ON GARMENTS)	COMPLETE CYCLE TIME (MINUTES)	MIN. WATER CONSUMPTION IN LITERS With Water Save
		WITH PRE-WASH	WITHOUT PRE-WASH	I	II	ECO	SOAK	WATER SAVE	RINSE HOLD	SPIN SPEED SELECTOR OR SPIN CANCEL	WITH ECO	STD			
COTTON 6kg. max	1. Prewash	✓		I	II	●	NO		●	●	60	90	Whites Heavily soiled cotton boil proof linen.	132	55
	2. Normalwash		✓	I	II	●	NO	●	●	●	60	90	Whites Medium soiled cotton or boil proof linen.	117	45
	3. Prewash	✓		I	II	●	YES		●	●	60	90	Whites Heavily soiled cotton or boil proof linen	132	55
	4. Normalwash		✓	I	II	●	YES	●	●	●	60	90	Whites Medium soiled cotton or boil proof linen	117	45
	5. Prewash	✓		I	II	●	YES	●	●	●	45	60	Normally soiled cotton or non boil proof linen	132	55
	6. Prewash	✓		I	II	●	NO	●	●	●	45	60	Less soiled cotton or non boil proof linen	132	55
	7. Normalwash		✓		II	NO	YES	●	●	●	-	60	Normally soiled cotton or non boil proof baby washing	117	45
	8. Normalwash		✓		II	●	NO	●	●	●	45	60	Less soiled cotton or non boil proof baby washing	117	45
	9. Prewash	✓		I	II	●	YES	●	●	●	45	55	Normally soiled cotton or blended linen coloureds	132	55
	10. Normalwash		✓		II	●	YES	●	●	●	45	55	Normally soiled cotton or blended linen coloureds	117	45
	11. Prewash	✓		I	II	●	NO	●	●	●	45	55	Less soiled cotton or blended linen which are colour fast coloureds	132	55
	12. Normalwash		✓		II	●	NO	●	●	●	45	55	Less soiled cotton or blended linen which are colour fast coloureds	117	45
	13. Light wash		✓		II	●	☐	●	●	●	45	45	Less soiled cotton fabrics (3 kg.max)	84	45
	14. Quick wash		✓		II	YES	☐	●	●	●	40	-	Delicate cottons (3 kg.max)	66	45
	15. Rinse					YES	☐	●	●	●	-	-	Three effective rinses with short intermittent spin followed by long spinning	45	35
	16. Additives			☼		YES	☐	●	●	●	-	-	Please refer fabric conditioner	24	11
	17. Long Spin					YES	☐			●	-	-	Draining of water & Extensive spinning of clothes followed by antcrease action	15	NIL
EASY CARE 3kg. max	18. Prewash	✓		I	II	●	NO	●	●	●	40	60	Easy care fabrics of cotton, polyester or polyester blends - very soiled	108	55
	19. Normalwash		✓	I	II	●	NO	●	●	●	40	60	Above washing - less soiled	96	45
	20. Prewash	✓		I	II	●	YES	●	●	●	30	50	Easy care fabrics of cotton, polyester or polyester blends - normally soiled	108	55
	21. Normalwash				II	●	YES	●	●	●	30	50	Above washing - Less soiled	96	45
	22. Delicates		✓		II	●	☐	●	●	●	30	40	Slightly soiled washing (once used towels, synthetic garments, nighties) (2 kg.max)	60	5
	23. Prewash	✓		I	II	YES	YES	NO	●	●	40	-	Synthetics curtains - heavily soiled	108	85**
	24. Normalwash		✓		II	YES	YES	NO	●	●	40	-	Synthetics curtains - less soiled	96	70**
25. Delicates		✓		II	NO	☐	NO	●	●	-	40	Slightly soiled washing (only once used or for extra delicate fabrics) (2 kg.max)	60	70**	
26. Rinse					YES	☐	●	●	●	-	-	Three effective rinses with short intermittent spins followed by gentle spinning.	39	35	
WOOLEN 2 kg. max	27. Wash		✓		II	☐	☐	☐	●	☐	-	40	Woolens with machine washable labels, extra delicate clothes which are not to be spin dried.	36	70
	28. Rinse					☐	☐	☐	●	☐	-	-	Three deep rinses	24	55
	29. Additives			☼		☐	☐	☐	☐	☐	-	-	Please refer fabric conditioner	12	17
	30. Pump					☐	☐	☐	☐	☐	-	-	Draining out water	3	NIL

- - Option Available
- ☐ - Option Not Available
- YES - Select Button
- NO - Do not Select the Button
- ** - Water consumption without 'water save option'

Depending on water pressure, water hardness, water inlet temperature, Quantity and type of textile, Detergents used, Degree of soiling, Ambient condition, selected additional functions & power supply fluctuations the actual values given on or with the machine can deviate from the declared standard values, as they are tested according to the laboratory conditions. Water consumption excludes the quantity of water taken during cool down cycle.

OPERATION

SORTING OF GARMENTS

- ❑ Machine to be used for machine washable fabrics only (Look for wash symbols given on your garments.)
- ❑ Wash woollens separately only if label on garments permits it.
- ❑ Non-fast coloured should be washed with like colours only at lower temperature.
- ❑ Wash whites separately from colours.
- ❑ Non - fast coloured to be washed at temperatures recommended by manufacturer.
- ❑ Check the pockets for any loose articles like coins,keys, keychains etc. Remove these articles as these can damage the drum/tub.
- ❑ Do not mix clothes that give lint with clothes that attract lint (e.g lint givers-woollens, socks, coarse cotton fabrics etc. Lint takers-synthetic fibres and corduroys).

LOADING THE MACHINE

- ❑ Open the front porthole door, place garments loosely inside drum. For best results load garments one by one.
- ❑ A wash load should preferably be a mix of large and small clothes.
- ❑ Turn knitted garments inside out, Remove loose hooks, rings and pins found on curtains etc. If pins/hooks cannot be removed tie a knot around them with the garment itself.
- ❑ **Close door and press till you hear a 'click'. Ensure that no cloth is jammed between door and rubber gasket of frame.**
- ❑ For large garments like bed covers and curtains etc. open out the garments and hold from the centre to load.
- ❑ Ensure that volume of load allows the clothes to tumble freely in the drum for best wash results.
- ❑ Over loading the drum will affect wash quality. It can also damage the machine and clothes in the long run.
- ❑ Running the machine under loaded may cause excessive vibration, noise and damage.

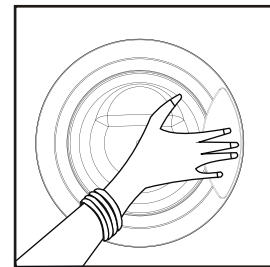
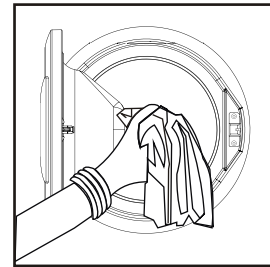

DETERGENT TO BE USED AND QUANTITY

- The best results will be achieved using correct amount of washing machine detergent.
- Approximate quantities to be used:
 - Full load i.e. 6 kgs Detergents to be used as per directions indicated by the manufacturer on their package or with self-judgement
 - Half Load
i.e. 3 kg and below Use 20 to 25% less detergent.
- Use liquid detergent only when a single wash is required, or use liquid detergent dispenser tray available as Accessories.
- Hard water and heavily soiled clothes require more than the recommended quantity of detergents.
- Do not use dry cleaning Agents.
- Frequent use of insufficient detergent will be noticeable as follows:
 - Washing appears grey or not properly clean
 - Grey - brown stains form on the washing
- Excess use of detergent will result in
 - Higher environmental pollution
 - Generation of too much foam
 - Scale builds up
 - Affect Rinse Quality

FABRIC CONDITIONER

- Fabric softener, Whitening, Enzyme, Disinfectants, bleaching, etc.
- Fill in the middle chamber of detergent dispenser tray marked 
 - Conditioner should be in liquid/solution form only (powders to be mixed in water.)
 - Fabric softener gives a soft feel and smooth surface to fabrics.
 - Whitener gives 'Whitness' to white clothes and brightness to coloured clothes.
 - Enzymes help to remove stains of sweat, blood etc.
 - Chlorine bleach is used for whites clothes and oxygen bleach is used for coloured clothes.
 - A strong bleaching agent is not recommended for direct use in the washing machine.
 - Extremely dirty areas in cloths can be pretreated with bleach and then be loaded in the machine for a regular wash.

TREATMENT OF STAINS

- Stains need to be treated immediately when they are fresh. Usually stains are categorised as absorbed stains, built-up stains, and compound stains.

- Absorbed stains can be removed by rubbing gently a pad containing a suitable solvent over the stain from outer edge towards centre by keeping stained cloth on absorbent fabric.
- Built up and compound stains may be removed by first carefully brushing off stained area. Then rub gently with a pad containing solvent from the back of fabric.
- It is advisable to try out the solvent on hidden part of the garment to verify its effect on cloth.

WASH LOAD GUIDE

Sheets Cotton	(D) (S)	1kg 500gms	Pajama/Kurta Shirt Cotton Others	400gms 280gms 200gms	Bedspread Blankets Wool acrylic	3kg 2.0kg 1.5kg
Other than Coton	(D) (S)	650gms 400gms	Blouse: cotton others	140gms 100gms	Sweaters(Wool) other heavy weight light weight	400gms 300gms 150gms
Pillow slips: Cotton others		110gms 85gms	Sarees: Cotton Synthetics Panties	650gms 350gms 60gms	Cotton vests Underslip	100gms 100gms
Bath towels Hand Towels		600gms 260gms	Socks: long(2pair) short(2pair)	150gms 85gms	Skits Trousers jeans	200gms 250gms 400gms
Tablecloths: small large		230gms 600gms	Hankies (6) Napkins(1doz)	85gms 1.1kgs		
Table Napkins (4)		150gms	Lungi/Dhoti	200gms		

D = Double

S = Single





- The chart indicates the average weight of clothes.
- The recommended weight of your wash should not be exceeded to ensure that your machine gives your clothes an effective wash.

INTERNATIONAL WASHING SYMBOLS

Washing Symbol	Wash Temp Max ^o C	Action
	95, 60, 40	normal
	30	gentle
	Do not machine - wash	handwash
	Do not wash in water	





IRONING

The number of dots indicate the maximum recommended temperature

-  Max 200° C,
-  Max 150° C,
-  Max 110° C,
-  Non - iron



DRY CLEANING

A circle symbolizes dry cleaning.

-  articles normal for dry cleaning in all solvents.
-  articles normal for dry cleaning in perchloroethylene, white spirit, Solvent 113 and Solvent 11
-  article normal for dry cleaning in fluorocarbon 113 or white spirit.
-  do not dry clean.



BLEACHING

A triangle symbolizes bleaching

-  bleaching
-  do not bleach

DRYING

A rectangle symbolizes drying

-  suitable for tumble-drying
-  do not tumble-dry

WOOL

Garments labeled as “ Machine Washable” can be washed in wool wash cycle at a temperature of 40° C



PROGRAMME RUN

Note:

- During the programme run the knob turns automatically in the clockwise direction only. Manual setting/advancement should not be done during programme run.
- Washing, Soaking Rinsing and Spinning can be seen through the porthole door.
- At any moment the position of the knob with respect to its start position shows how far the programme has advanced.
- The starting point is just beyond the thick line on the Facia.

SWITCHING OFF THE MACHINE

- The wash ends automatically at the end of each programme at the thick line.
- To switch the machine OFF release the START button.
- The indicator lamp goes off.
- Porthole door can be opened after 90 seconds of switching off the machine.
- Remove clothes from inside the machine
- Leave door slightly ajar to dry out the inside of the machine.

CHECK POINTS

Before switching your machine 'ON' check...

- The machine is plugged in and switched on to a 220V, 50 Hz supply with proper earthing.
- The water inlet stopcock is fully open.
- The hoses are not bent or twisted.
- Dry clothes are loaded into the machine drum, and door is closed firmly with a 'click'.
- The required amounts of detergents and fabric conditioner are filled in their respective compartments.
- The Water Save Device Button, Rinse Hold Button, soak button, Eco button, is pressed if required.
- The spin speed selector knob is turned to Appropriate position.
- The programme Selector knob is turned to the appropriate programme position in a **clockwise direction only**. This is very important.
- The Coin Trap/drain hose is not open.
- Start Button is pressed.

MAINTENANCE

COIN TRAP

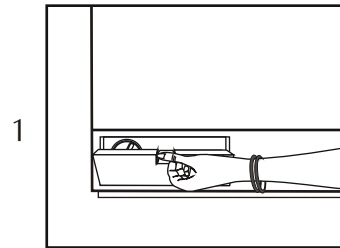

Open the bottom door, which is detachable by pressing the top portion of it.

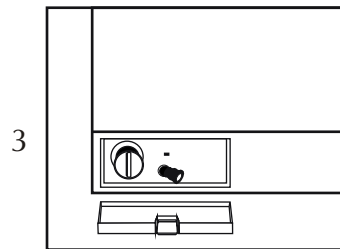

After draining out the water through the drain plug, open the coin trap by rotating in anticlockwise direction and remove the foreign particles like coins, pins, hooks, present if any. Tighten the coin trap and drain plug to their original positions and close the bottom door.

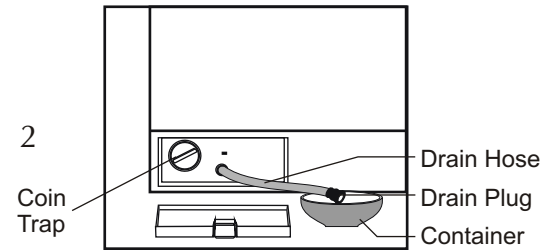

Place a shallow container near the bottom door. Pull out the drain hose and open the drain plug to drain out the water from the machine in the container.

Before using the machine again, run the machine without clothes and detergent by selecting any short wash programme. This will ensure that the water system line gets filled with water.

Alternatively pour two mugs of water (approx. 1.5 ltrs.) directly into the drum.

Do not open the coin trap during a programme run.

DRUM

Rust Stains

Never leave metal items e.g. paper clips, safety pins etc. in the drum as there is a danger of rusting. If there are any rust stains remove with a non-chlorine agent. Special non-metal sponges (never use steel wool) may also be used.

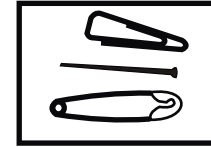

SIEVES

Cleaning of Water Connection Sieves, Filter

1. Turn off Taps. Disconnect Power supply to the machine. Unscrew inlet hose from machine as well as from the tap and drain out water from the hose.
2. Pull the sieve out the magnetic valve with a pair of flat nosed pliers and clean under running water with a brush.
3. Fit Sieve back to the valve.
4. Remove the filter mesh from the tap end of the inlet hose and clean under running water with a brush.
5. Fit the filter mesh back to inlet hose.
6. Screw inlet hose back to the machine and the tap. Ensure that both the sieve and gasket are in place.
7. Turn on the tap.

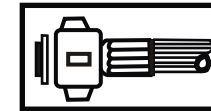

Cleaning of Porthole Door Area:

- After every wash clean vapour off porthole door.
- Lift the fold in the rubber gasket under porthole periodically to remove lint and dirt preferably after every wash.

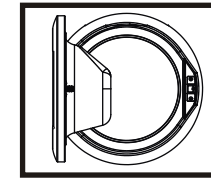

FROST PROTECTION

If the machine is being operated in very cold temperature, all the water should be drained out after use.

- Locate the drain hose and drain the water.
- Disconnect inlet hose from the tap and drain.

DRAINING DURING EMERGENCIES

In case of a long power failure during a programme run, the water can be drained from the drum through the drain hose

- Allow the water in the machine to cool down sufficiently.
- Locate the drain hose and pull out the drain plug to drain water in a large shallow container.
- Before restarting machine, ensure that drain plug is fixed on drain hose properly and coin trap water line is filled with water by running the machine without any clothes or detergents.
- Spillage of water can rust the base plate. Draining through drain hose prevents rusting.

FAULT DIAGNOSIS

WHY DOES IT HAPPEN?

INDICATOR LAMP DOES NOT GLOW.

- Check if the machine is ON.
- Check for loose connections in plug/socket.

WATER DOES NOT ENTER MACHINE/DETERGENT NOT BEING FLUSHED INTO DRUM.

- Check water supply
- Porthole door not firmly closed
- Water tap not turned on
- Bent inlet hose
- Sieve on inlet valve clogged

SUDS ESCAPING FROM DETERGENT DISPENSER TRAY.

- Detergent used is not a front loading washing machine detergent
- Excessive detergent used

WATER LEAKAGE FROM THE MACHINE.

- Inlet/Outlet hose connection loose
- Coin trap cover or drain plug not screwed on properly
- Inlet hose leaking

MACHINE DOES NOT DRAIN.

- Outlet hose end above 1 mtr. from floor level

MACHINE VIBRATES STRONGLY DURING SPINNING.

- Machine not levelled properly
- Clothes not loaded as instructed

MACHINE DOES NOT START.

- Check position of programme selector knob
- Check water supply
- Porthole door not closed properly
- Indicator lamp not glowing

MACHINE DOES NOT SPIN.

- Check if the Spin speed selector knob is set on No spin Position.
- Rinse Hold button is pressed
- Unbalanced load

MOTOR NOISE

It is normal for noises to be heard while motor is running. However wash load, belt tension and motor mounting bolt should be checked for specified limits.

PUMP NOISE

It is normal for noises to be heard from the pump during the start-up and final stage of draining.

SAFETY PRECAUTIONS

1. Ensure that the machine is properly balanced on four adjustable feet.
2. Ensure that the machine is connected to 3 pin socket with earth and 16 amps fuse.
3. The machine is tested with water during assembly for performance checking. Condensed droplets of water may remain inside the drum. It is advisable to run the machine without wash load at 60°C with detergent for the first time after installation.
4. The programme knob should be turned clockwise only.
5. Programme selection must be done prior to switching on the machine. For resetting of programme, switch off the machine, select the programme and re-start. The programmer knob should not be Advanced Ahead Manually once the programme is selected & Running, as it may affect the performance of the machine due to excessive vibrations.
6. Press the START button to switch on the machine and release it to switch it off.
7. Servicing should be handled by the Company's authorized personnel only.
8. The door can be opened only after 90 seconds when the wash cycle is over or machine is switched off. This is a safety feature. The door should not be forced open.
9. Check label on garments for determining conditions under which fabrics are to be washed.
10. Use detergent recommended for washing machine.
11. Ensure that the electrical line on which the machine is used can take the required load.
12. Check the inside of drum before loading the clothes.
13. Protect the machine from direct sunlight and do not splash water on it. Clean with a damp cloth.
14. Keep your machine dry to avoid corrosion / rusting. Take special care to wipe the machine after cleaning the coin trap.

15. The machine should be ideally installed on the floor. It can be installed on any suitable platform or trolley, if desired by the customer.
16. Clean the shell lower and detergent tray periodically by taking out the detergent tray.
17. Prolonged use of water carrying impurities, salts etc. may result in scale formation on the surfaces of the components that are exposed to water. Periodical descaling using approved descaling agent is advisable for longer life of the components.

SPECIAL NOTE

ONLY USE A DETERGENT RECOMMENDED FOR FRONT LOADING WASHING MACHINES. A DETERGENT WHICH FOAMS EXCESSIVELY CAN DAMAGE THE MOTOR AND DETERIORATE THE RINSE QUALITY.

INSTALL MACHINE IN A ROOM WITH ADEQUATE VENTILATION. AVOID A ROOM WITH NO WINDOWS. THE BACK OF THE MACHINE SHOULD BE AT LEAST 4 INCHES (100 mm) AWAY FROM THE WALL.

IF YOU USE A COVER OR TABLE CLOTH ON THE TOP LID, MAKE SURE THAT THE VENTILATION SLOTS AT THE BACK ARE NOT COVERED OR BLOCKED. THIS PRECAUTION WILL PROLONG THE LIFE OF ELECTRICAL AND RUBBER COMPONENTS.

TECHNICAL DATA

Dimensions(DxWxH)	:	64 cm x 60 cm x 85 cm
Weight	:	78 kgs
Capacity	:	6 Kgs of dry clothes (cotton)*
Programmes	:	30 Wash Care Programmes
Selector Buttons	:	Eco, Soak, Water Save Device (WSD), Rinse Hold
Motor Rating	:	690 Watts max.
Spin Speed	:	400 to 1100 rpm or No Spin
Heater Rating	:	1.9 kW
Drum	:	Stainless Steel
Temperature Selection	:	Cold to 90°C
Drain Pump Rating	:	30 Watts
Water Consumption	:	45 litres for normal wash.
Power Consumption	:	0.15 - 0.25 unit for cold wash
(Cotton Wash Programme)	:	1.2 - 1.4 unit hot wash at 60°C
Connected Load	:	2.35 KW Max.
Programme Duration	:	3 to 132 minutes
Power supply	:	220-240 V, Single Phase, 50 Hz
Water Pressure	:	1 bar (1.03 kg/cm ²) - 10 bar (10.3 kg/cm ²)

Specifications are subject to change without notice.

*Capacity depends on size, texture and combination of clothes
Depending on water pressure, Water hardness, Water inlet Temperature, Quantity and type of textile, Detergents used, Degree of soiling, Ambient condition, selected additional functions & power supply fluctuations the actual values given on or with the machine can deviate from the declared standard values, as they are tested according to the laboratory conditions

I OWN THE FOLLOWING PRODUCTS: (Please tick in the box)

- | | | |
|--------------------------------------|---|--|
| <input type="checkbox"/> COLOUR TV | <input type="checkbox"/> REFRIGERATOR | <input type="checkbox"/> AIR CONDITIONER |
| <input type="checkbox"/> DISH WASHER | <input type="checkbox"/> MICROWAVE OVEN | <input type="checkbox"/> CLOTHES DRYER |

FRANCHISEE ATTACHED: _____

CUSTOMER COPY

MODEL : SENATOR AQUA 6KG B SERIAL NO. WTSTRAQ 6kgB _____

DEALER'S NAME : _____

CUSTOMER'S NAME : _____

ADDRESS : _____

PIN CODE : _____

TEL. NO. (Resi.) _____ (Off.) _____

E-MAIL : _____

MOTOR SR. NO. : _____

DATE OF PURCHASE : _____



SERVICE STATION COPY

MODEL : SENATOR AQUA 6KG B SERIAL NO. WTSTRAQ 6kgB _____

DEALER'S NAME : _____

CUSTOMER'S NAME : _____

ADDRESS : _____

PIN CODE : _____

TEL. NO. (Resi.) _____ (Off.) _____

E-MAIL : _____

MOTOR SR. NO. : _____

DATE OF PURCHASE : _____

ALSO FROM IFB



MICROWAVE OVEN
CAPACITY - 17 to 30 LITERS



CLOTHES DRYER
CAPACITY - 5.5KG



DISHWASHER
CAPACITY - 12 PLACE SETTING

IFB

Customer Care

Dial

1901 425 5678 - BSNL & MTNL Callers

3900 4321 - Other Callers