

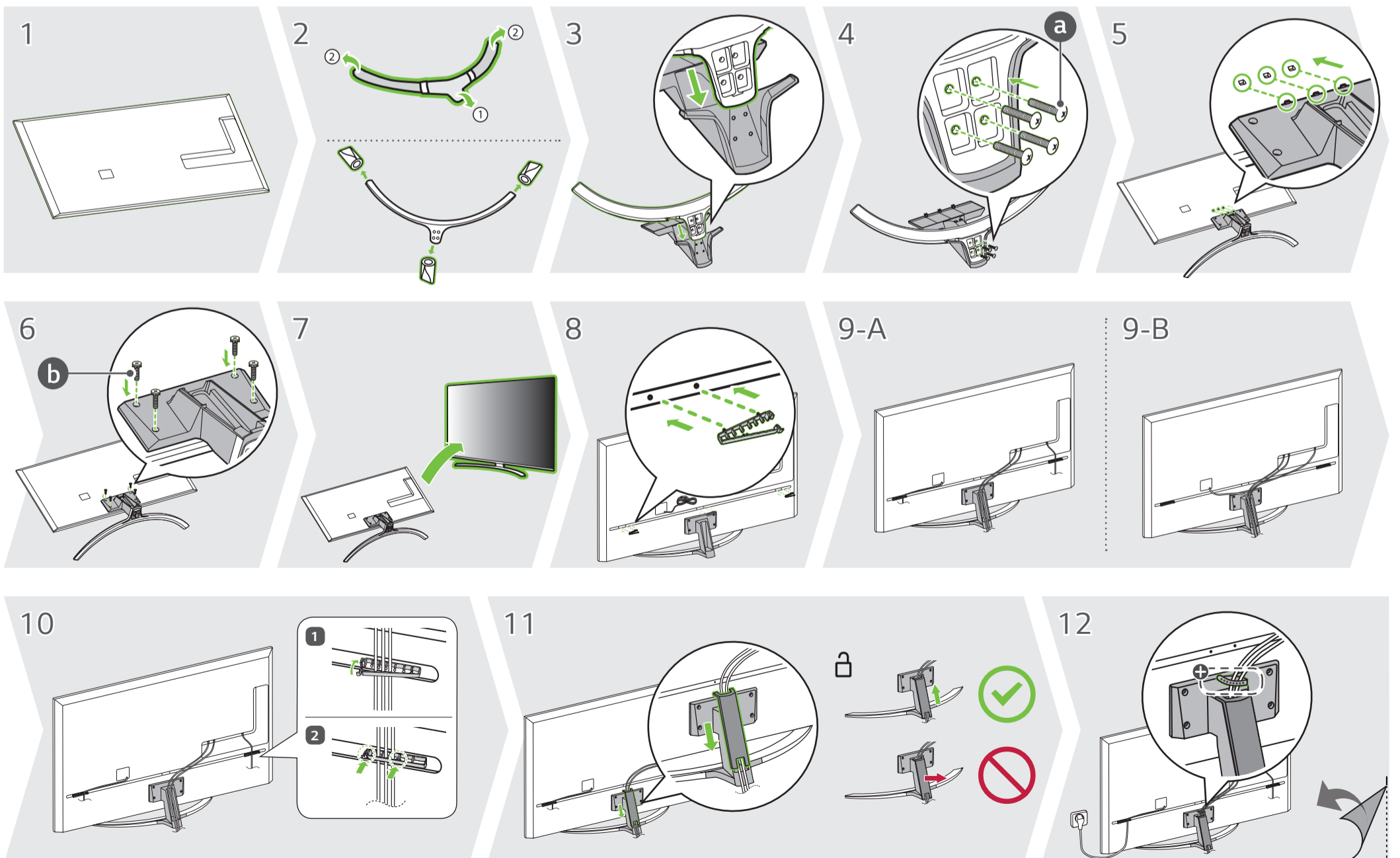

QNED91\*

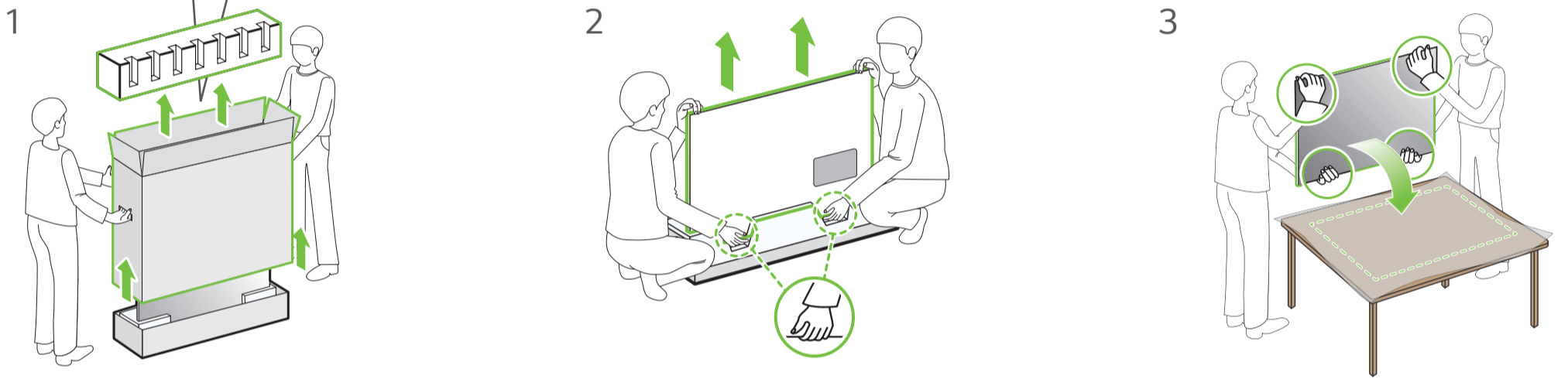

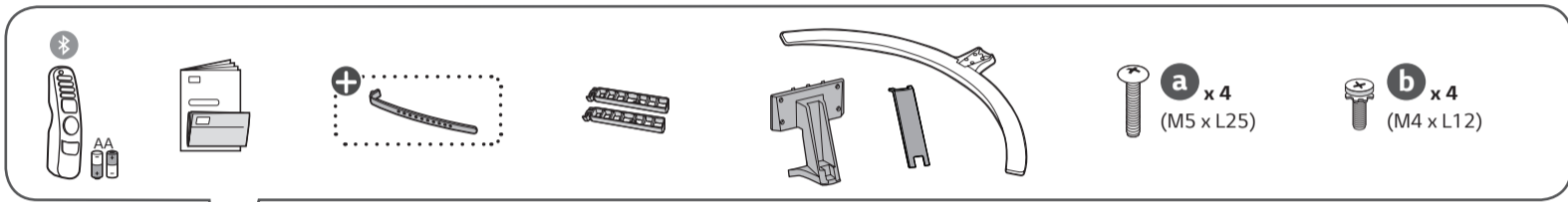
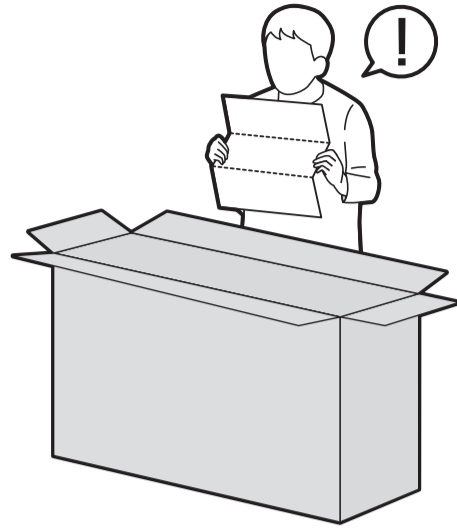
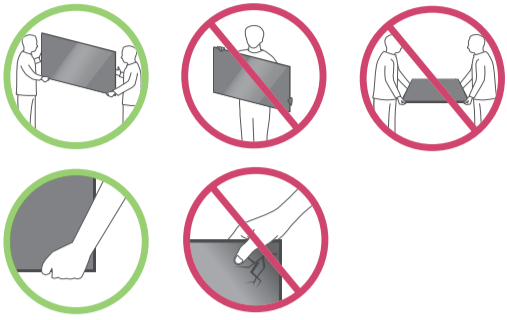
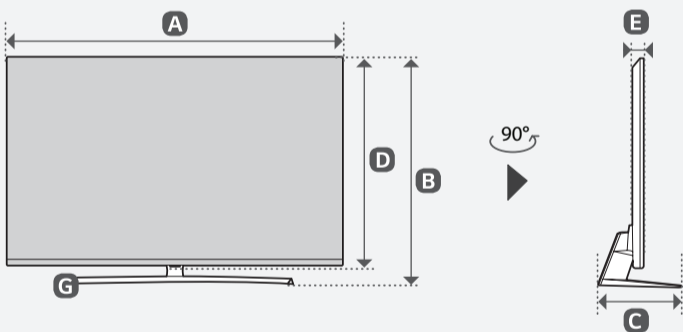
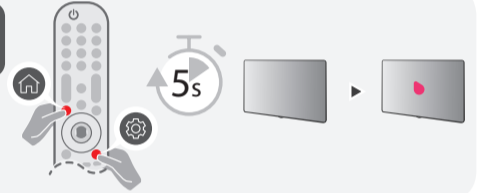
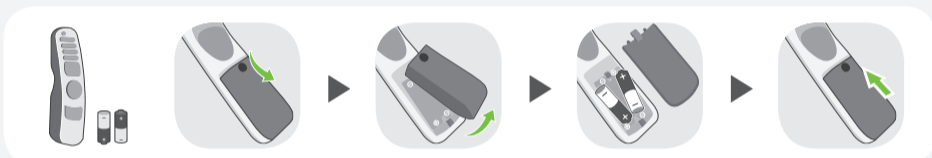
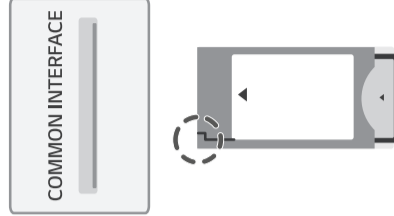
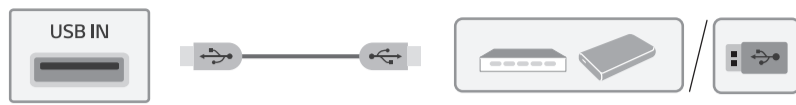
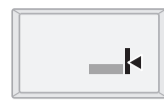
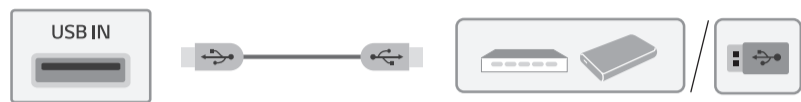
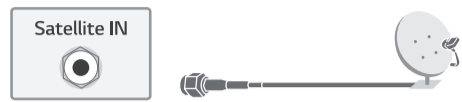

	A	B	C	D	E	F	F-G
	(mm)					(kg)	
65QNED913PA 65QNED916PA 65QNED919PA	1444	902	336	834	29.5	28.4	26.7
Power requirement	AC 100-240 V - 50 / 60 Hz						



English	• Read Safety and Regulatory.	Hrvatski	• Pročitajte <b>Sigurnost i uskladenost s propisima.</b>	Română	• Consultați manualul referitor la <b>siguranță și reglementare.</b>
Deutsch	• Lesen Sie die <b>Sicherheitsanweisungen und Richtlinien.</b>	Shqip	• Lexoni paragrafin " <b>Siguria dhe rregullimi</b> ".	Български	• Прочетете <b>Безопасност и регулаторни стандарти.</b>
Français	• Lire le document <b>Sécurité et mesures réglementaires.</b>	Bosanski	• Pročitajte dio <b>Sigurnost i propisi.</b>	Eesti	• Lugege <b>ohutus- ja normatiivteavet.</b>
Italiano	• Leggere il manuale <b>Sicurezza e normativa.</b>	Македонски	• Прочитajte за <b>безбедноста и регулативата.</b>	Lietuvių k.	• Perskaitykite <b>Saugos ir norminius reikalavimus.</b>
Español	• Leer <b>Seguridad y normativa.</b>	Svenska	• Läs <b>Säkerhet och föreskrifter.</b>	Latviešu	• Izlasiet sadaļu <b>Drošība un normatīvi.</b>
Português	• Ler informações sobre a <b>Segurança e Regulamentos.</b>	Magyar	• Biztonsági szabályzat megtekintése.	Srpski	• Pročitajte odeljak <b>Bezbednost i regulatorna pitanja.</b>
Nederlands	• <b>Veiligheidsinformatie en regelgeving</b> lezen.	Polski	• Prosimy o przeczytanie <b>Zasad bezpieczeństwa i uwag dotyczących przepisów.</b>	Norsk	• Les <b>sikkerhet og forskrifter.</b>
Ελληνικά	• Διαβάστε τις <b>οδηγίες για την ασφάλεια και τους κανονισμούς.</b>	Česky	• Přečtěte si část <b>Bezpečnost a zákonné předpisy.</b>	Dansk	• Læs <b>sikkerhed og lovmæssige bestemmelser.</b>
Slovenščina	• Preberite <b>varnostne in regulativne vidike.</b>	Slovenčina	• Prečítajte si <b>bezpečnostné a regulačné informácie.</b>	Suomi	• Lue <b>Turvallisuus ja säännökset</b> -osio.

⊕ : Depending on model / Abhängig vom Modell / Selon le modèle / In base al modello / En función del modelo / Dependendo do modelo / Afhankelijk van het model / Αν λογα με το μοντ λο / Odvisno od modela / Tipusfüggő / Zależnie od modelu / Závísí na modelu / V závislosti od modelu / In functie de model / в зависимости от модели / Sõltub mudelist / Priklauso nuo modelio / Atkarībā no modeļa / U zavisnosti od modela / Ovisno o modelu / Në varësi të modelit / Ovisno o modelu / во зависност од моделот / Beroende på modell / Avhengig av modell / Afhængigt af modellen / Mallin mukaan