

Juke Bar
ZEB 3850 *pro*
Dolby Atmos



User Manual

www.zebronics.com

Important Safety Instruction

Thank you for purchasing the **ZEB-JUKE BAR 3850 PRO DOLBY ATMOS** Soundbar. Please read this user manual carefully and keep for future reference.

Warning

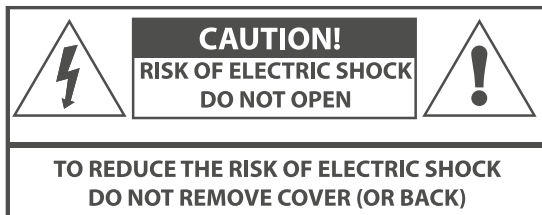

Caution:

- To reduce the risk of electric shock, do not dismantle the product and do not expose the apparatus to rain or moisture. No user-serviceable parts inside.
- Refer servicing to qualified personnel only.



The lightning flash within an equilateral triangle is intended to alert you to the presence of uninsulated dangerous voltage within the product's enclosure that may be of sufficient magnitude to constitute an electric shock to a person or persons.



Important! This symbol alerts you to read and observe important warnings and instructions on the unit or in this manual.

Notice:

This appliance is not intended for use by persons (including children) with reduced physical sensory or mental capabilities, or lack of experience and knowledge, unless they have been given supervision or instruction concerning use of the appliance by a person responsible for their safety.

Children should be supervised to ensure that they do not play with the appliance.

1. To prevent possible hearing damage, do not listen at high volume levels for long time periods or a sudden high volume level.



2. Never use the device unsupervised! Switch off the device whenever you are not using it, even if not using it only for a short while.
3. The appliance is not intended to be operated by means of an external timer or separate remote control system.
4. If the supply cord is damaged, it must be replaced by the manufacturer, its service agent or similarly qualified persons in order to avoid a hazard.
5. Before operating this system, check the voltage of this system to see if it is identical to the voltage of your local power supply.
6. The unit should not be impeded by covering the ventilation opening with items such as newspaper, table-cloths, curtains etc. Make sure that there are at least 20 cm of space above and at least 5 cm of space on each side of the unit.
7. The apparatus must not be exposed to dripping or splashing liquid, no objects filled with liquids such as vases, should be placed on the apparatus.
8. To prevent fire or shock hazard, do not expose this equipment to direct heat, rain, moisture or dust.
9. Do not position this unit near any water sources e.g. taps, bathtubs, washing machines or swimming pools. Ensure that you place the unit on a dry, stable surface.

10. Do not place this unit close to a strong magnetic field.
11. Do not place the unit on a amplifier or receiver.
12. Do not place this unit in a damp area as the moisture will affect the life of electric components.
13. Do not attempt to clean the unit with chemical solvents as this might damage the finish. Wipe with a clean, dry or slightly damp cloth.
14. When removing the power plug from the wall outlet, always pull directly on the plug, never pull on the cord.
15. Depending on the electromagnetic waves used by a television broadcast, if a TV is turned on near this unit while it is also on, lines might appear on the LED TV. Neither this unit nor the TV is malfunctioning. If you see such lines, keep this unit well away from the TV set.
16. The mains plug is used to disconnect the device, the disconnected device should remain readily operable.

Important Safety Instructions

1. Read, keep and follow all instructions. Heed all wanings.
2. Avoid dropping. Do not disassemble.
3. Do not use any corrosive cleaner/oil to clean. Clean only with dry cloth.

4. Do not submerge in water; do not use this apparatus near water. The product should not be exposed to dripping or splashing water.

5. Do not block any ventilation openings. Install it in accordance with the manufacturer's instructions.

6. Avoid extreme temperatures. Do not install near any heat sources such as radiators, heaters, stoves, or other apparatus (including amplifiers) that produce heat.

7. Protect the power cord from being walked on or pinched particularly at plugs, convenience receptacles or at the point where they exit from the apparatus.

8. Only use original or certified cables or attachments/accessories specified by manufacturer.

9. Do not use the device outdoors during thunderstorms, Unplug this apparatus during lightning storms or when unused for long periods of time.

10. Refer all servicing to qualified service personal. Servicing is required when the apparatus has been damaged in any way, for example, when the power-supply cord or plug is damaged, liquid has been spilled or objects have fallen into the apparatus, the apparatus has been exposed to rain or moisture, does not operate normally, or has been dropped.

11. The AC plug is used to disconnect the device; the disconnected device should remain

readily operable. In order to disconnect the apparatus from the AC power completely, the AC plug must be removed from the AC outlet completely.

Preparation for Use

Unpacking and Set Up

- Remove the Sound bar from the carton and remove all packing material from the Sound bar. Save the packing material, if possible, in case the Sound bar ever needs to be serviced or transported.
- The original carton and packing material is the only safe way to pack your Sound bar to protect it from damage in transit.
- Remove any descriptive labels or stickers on the front or top of the cabinet. Do not remove any labels or stickers from the back or bottom of the cabinet.
- Place your Sound bar on a level surface such as a table, desk or shelf, convenient to an AC outlet, out of direct sunlight, and away from sources of excess heat, dirt, dust, moisture, humidity, or vibration.
- Unwind the Line cord connecting the AC adapter and extend it to its full length.

Protect Your Furniture

This model is equipped with non-skid rubber 'feet' to prevent the product from

moving when you operate the controls. These 'feet' are made from non-migrating rubber material specially formulated to avoid leaving any marks or stains on your furniture. However certain types of oil based furniture polishes, wood preservatives, or cleaning sprays may cause the rubber 'feet' to soften, and leave marks or a rubber residue on the furniture. To prevent any damage to your furniture we strongly recommend that you purchase small self-adhesive felt pads, available at hardware stores and home improvement center everywhere, and apply these pads to the bottom of the rubber 'feet' before you place the unit.

Important Notes

- Safety and operating instruction manual should be retained for future reference.
- The apparatus should not be exposed to dripping, splashing or placed in a humid atmosphere such as a bathroom.
- Do not install the product in the following areas:
 - Places exposed to direct sunlight or close to radiators.
 - On top of other stereo equipment that radiate too much heat -Blocking ventilation or in a dusty area.
 - Areas where there is constant vibration.

- Humid or moist places.
- Do not place near candles or other flames.
- Operate the product only as instructed in this manual.
- Before turning on the power for the first time, make sure the sound bar is plugged to power outlet.
- For safety reasons, do not remove any covers or attempt to gain access to the inside of the product. Refer any servicing to qualified personnel.
- Do not attempt to remove any screws, or open the casing of the unit; there are no user serviceable parts inside. Refer all servicing to qualified service personnel.

Power Source:

This soundbar is designed to operate in AC 220-240V ~ 50/60Hz.

Product Representation Sound Bar

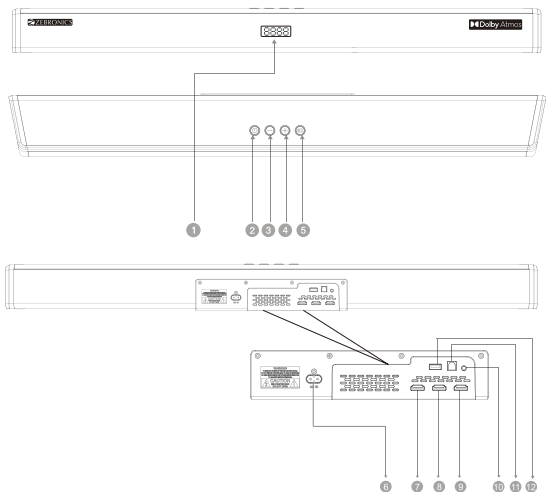

1. Display Panel.
2. Standby-on: Switch the Soundbar On or to standby.
3. Volume: Decrease the volume.
4. Volume: Increase the volume.
5. INPUT: Select an input source for the Soundbar.
6. AC IN: Connect to power supply.
7. HDMI IN 2: Connect to HDMI OUT of TV/Satellite/ Set-top box/BD/Blue Ray DVD/DVD player.
8. HDMI IN 1: Connect to HDMI OUT of TV/Satellite Set-top box/BD/Blue Ray DVD/DVD player.
9. HDMI OUT (ARC): Connect to HDMI (ARC)/HDMI IN on TV.
10. AUX: Auxiliary Audio input from Mp3/Phone/set-top box devices.
11. OPTICAL: Connect to an optical audio output on TV or digital devices.
12. USB PORT: Audio input from a USB storage device.

Remote Control

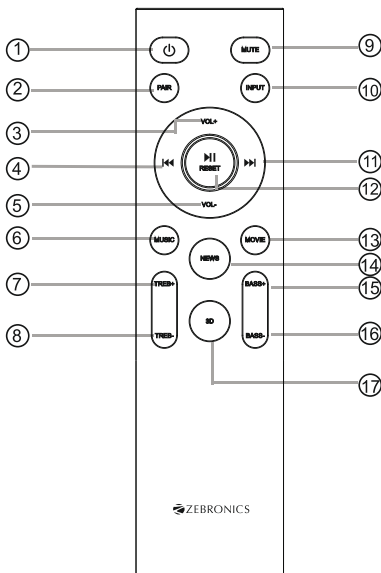

1. Power button: Press to switch the sound bar on/ off or standby mode.

2. Pair button: long-press pair button more than 2 seconds to connect and disconnect last device. short-press pair button, the display will be shown " **ON** "; it is indicated that the surround effectiveness is switched on. Short-press pair button again, the display will be shown " **OFF** "; the surround effectiveness is switched off.

3. **VOL+** : to increase the volume.

4. **⏮** Previous button: Skip to the previous track in USB & BT mode.

5. **VOL-** : to decrease the volume.

6. Music button: to select and activate the music EQ effect and mode .
7. Treble-up button: to increase the treble volume.
8. Treble-down button: to decrease the treble volume.
9. Mute button: To temporarily turn off the sound. Press the button again to turn the sound back on.
10. Source input button: to select an input source for playback:
 - ARC : sound from connected HDMI ARC device
 - Hd 1 : sound from connected HDMI 1 port
 - Hd 2 : sound from connected HDMI 2 port
 - bLUE : sound from connected Bluetooth drive.
 - AUX : sound from connected Auxiliary Line-in
 - USB : sound from connected USB driver
 - OPTI : Sound from connected Digital Optical device.
11. ►► Next button: Skip to the next track in USB & BT mode.
12. ■■ Reset: Play/Pause button: Start, pause or resume play in USB & BT mode.
 - Reset button: Press and hold the button more than 2 seconds to restore factory default settings.
13. Movie button: To select and activate the movie EQ effect and mode.
14. News button: To select and activate the news voice EQ effect and mode.
15. Bass+ button: To increase the bass.
16. Bass- button: To decrease the bass.
17. 3D button: To select and activate the 3D EQ effect and mode.

Operating range of the remote control

- When the unit is mounted on a wall, point the remote control at the remote control sensor on the bellowed panel. The provided Remote Control allows the unit to be operated from a distance.
- Even if the Remote Control is operated within the effective range 26.2 feet (8m), remote control operation may be impossible if there are any obstacles between the unit and the remote control.
- If the Remote Control is operated near other products which generate infrared rays, or if other remote control device using infrared rays are used near the unit, it may operate incorrectly. Conversely, the other products may operate incorrectly.

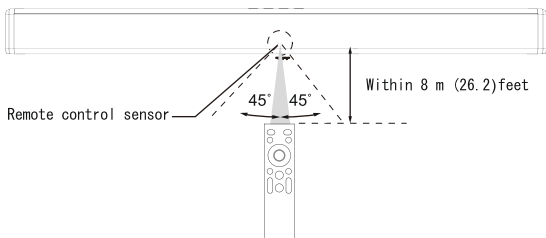

Positioning the Sound Bar

Table Placement

- Place the sound bar horizontally on a flat surface such as a TV unit or shelves and align it centrally with the TV screen.
- For best sound output and good airflow around the soundbar, place your soundbar as shown.

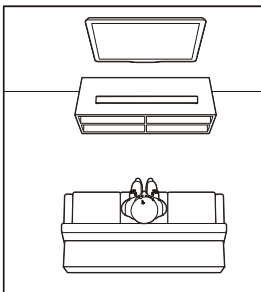

Wall Mount Installation

1. Open 4 holes in the wall referring to iron bracket for wall mounting, the spacing of the holes in the wall is corresponding to the distance between sound bar pads.
2. Fix the plastic anchor M the 4 holes of the wall mounting bracket.
3. Fix the screws on the plastic anchor and tighten the screws to ensure that the wall mounting bracket will not shake.
4. After fastening the screws, Put the sound bar pads into the extension of the wall mounting bracket.

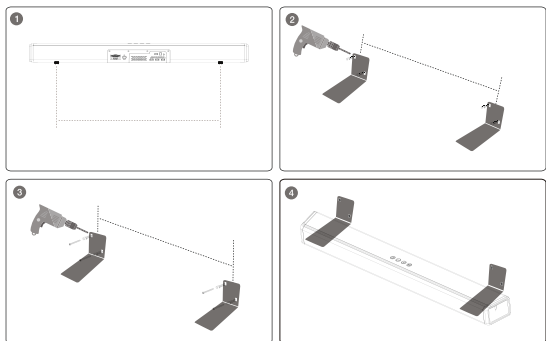

Using the Soundbar

- Before connecting the AC power cord, ensure you have completed all other connections.
- Risk of product damage! Ensure that the power supply voltage corresponds to the voltage printed on the back or the underside of the unit.
- Connect the mains cable to the AC IN of the unit and then into a mains socket.
- Power cord quantity and plug type vary by regions.

Basic Operation

1. Press the power button on either the remote control or the sound bar to turn on the sound bar.
2. Switch on the connected device (such as TV, playback devices, game console etc).

3. Press the input button on either the remote control or the sound bar to select your desired input source.

Input Source	Description
HDMI 1 & HDMI 2	Sound from a connected device (via HDMI IN port)
ARC / OPTICAL	Audio from TV (via HDMI ARC port or OPTICAL jack)
AUX	Sound from a connected device (via AUX port)
BLUETOOTH	Sound from a Bluetooth connected device
USB	Sound from a USB storage device

Note: Keep the sound bar display mode the same as input source. For example, if input source is HDMI ARC, Meanwhile the display will be switched to ARC on the screen of sound bar.

Power ON and OFF

1. Plug in the power cord with one side to AC IN on sound bar and the other side to an AC wall outlet (see the following diagram). When you connect the soundbar to the main socket, the unit will be in STANDBY mode, firstly it will display-

2. Switch on the sound bar by short-pressing  button on sound bar or on remote controller, then it will flow display **WELCOME** from right to left. After 12s, the default input mode will automatically appear on display screen.

3. Press and hold the  button on sound bar or on the remote controller for 2 seconds to switch it off, and then disconnect the main plug from the main socket if you want to switch the unit off completely.

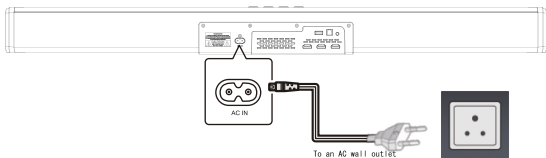

Auto Standby

1. The unit will automatically turn to standby mode when no audio input is received for 20 minutes. The sound bar will wake up from standby mode when any button is pressed or source input is received.
2. If the TV or the external unit is disconnected, switched it off
 - To switch the unit off completely, remove the mains plug from the mains socket.
 - Please turn the unit off completely to save energy when not in use.

Select Modes

1. Press the  button repeatedly on the soundbar or press the INPUT button on the remote control to select the BT, AUX, OPTICAL, HDMI ARC, HDMI 1, HDMI 2, USB mode. The selected mode will show on the display
2. Below are input mode names appearing in the sound bar display: BLUE-Bluetooth Pairing mode, **AUX** - AUX mode, **OPTI** - Optical mode, **Hd 1** - HDMI 1 mode, **Hd 2** - HDMI 2 mode, **ARC** - HDMI (ARC) OUT mode, **Usb** - USB mode

The port of HDMI in and HDMI(ARC) are support Video & Audio

Video : Max supported video content
1080p / 4K / HDR / 60fps

Audio : Maximum supported audio content is Dolby Atmos, Dolby Digital, Dolby Digital Plus, Dolby TrueHD, Dolby Surround.

HDMI : HDMI version 2.0

Playing Audio via BT Connection



Through Bluetooth, connect the Soundbar with your Bluetooth device (such as an iPad, iPhone, iPod touch, Android phone, or laptop), and then you can listen to the audio files stored on the device through your Soundbar speakers.

What you need



- A Bluetooth device which supports Bluetooth profile A2DP, AVRCP and with Bluetooth version as 5.0.
- The maximum operational range between the Soundbar and a Bluetooth device is approximately 8 meters (26.2 feet).

1. Turn on the sound bar and short-press a button repeatedly on the unit or  INPUT button on the remote control to switch the sound bar to Bluetooth model and LED display **bLUE** on the sound bar will flicker in the Bluetooth pairing mode.

2. On the Bluetooth device, switch on Bluetooth, search for and select **ZEB-JUKE BAR 3850 PRO DOLBY ATMOS** on your Bluetooth list to start connection (see the user manual of the Bluetooth device on how to enable Bluetooth) if prompted for a password, please use "0000".

3. Wait until you hear the voice prompt from the Soundbar. If the successfully connected, **bLUE** stops flickering and is displayed on the display panel.

4. Select and play audio files or music on your Bluetooth device.

- During play, if a call is coming, music play is paused. Play resumes when the call ends
- If your Bluetooth device supports AVRCP profile, on the remote control you can press   to skip to a track, or short-press  to pause/ resume play; Press and hold the **RESET** button more than 2 seconds to restore factory default settings; Hold **Pair** button on the remote control for more than 2 seconds to disconnect paired BT device or connect

back last disconnect BT device.

5. You can use the volume buttons on the sound bar or on the remote controller to adjust the volume to your requirements

6. To exit Bluetooth, select other relevant input source.

- When you switch back to Bluetooth mode, Bluetooth connection remains active.

7. Press the **VOL +/-** buttons to adjust the volume to your desired level.

Notes:

- *Having connection problems? Remove **ZEB-JUKE BAR 3850 PRO DOLBY ATMOS** from your device's Bluetooth history and ensure it's less than 8 meters away. Then try pairing again. To get the best sound quality, make sure there is a clear line of sight between the connected device and your sound bar.*

- *If your pairing device or connected device is switched off or manually disconnected, the sound bar will automatically enter pairing mode.*

- *The music streaming may be interrupted by obstacles between the device and Soundbar, such as wall, metallic casing that covers the device, or other devices nearby that operate in the same frequency.*

- *If you want to connect your Soundbar with another Bluetooth device, press and hold Pair on the remote control to disconnect the currently connected Bluetooth device.*

Connections

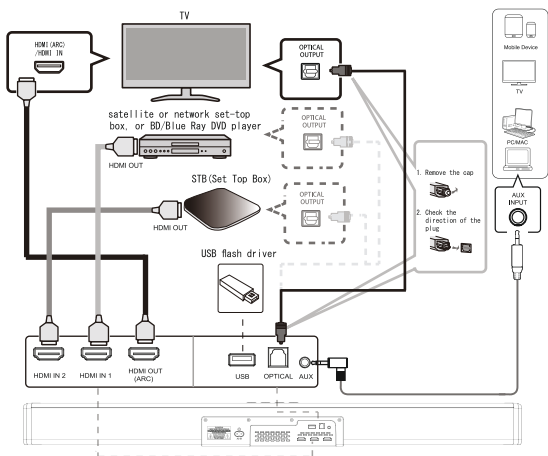

Playing Audio via USB Port

The sound bar automatically switches to USB input mode with the LED display **Usb** when a USB flash drive is inserted (this mode isn't selectable on the sound bar or remote control unless a USB flash drive is connected).

1. Ensure that your USB flash drive contains MP3 audio files (other file types not supported)
2. Connect the USB flash drive to the USB port on the sound bar (or your own USB extension cable connected to the USB port); music will automatically play with LED display "00:00", when music is played on, the play time will be automatically displayed on the screen.

3. Press the **VOL +/-** buttons to adjust the volume to your desired level.
4. During playback:

 Start, pause or resume play.
 Skip to the previous or next track.

Playing Audio via Audio input (AUX) Connection

- Use a 3.5mm to 3.5mm audio cable (included) to connect the PC, tablet, smartphone, TV's headphone socket to the AUX socket on the soundbar.
- Use a RCA to 3.5mm audio cable (not included) to connect the Blue Ray DVD Player / TV's audio output sockets to the AUX socket on the soundbar.
- Then short-press the  button on the sound bar or on the remote controller to switch to audio input mode with LED display lighting up **AUX**.
- In this mode, playback can only be controlled on your connected device

***Note:** For some computer, you may need to access the audio control panel to manually set the soundbar as above picture.*

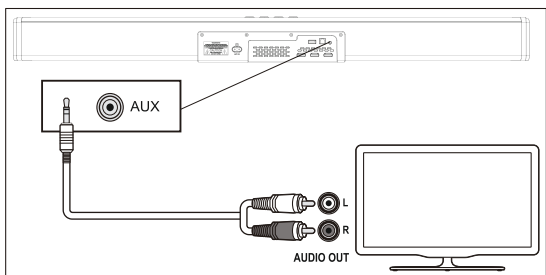
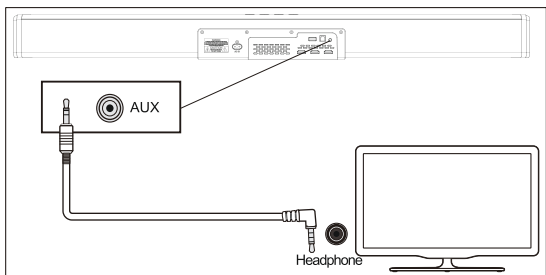

Optical Mode

Using an optical cable, connect the OPTICAL connector on your Soundbar (Optical digital input) to the OPTICAL OUT connector on the TV or other device. The TV or other device must have an optical digital output. Proceed as follows:

- Connect the optical cable to the OPTICAL jack on the rear of the sound bar.
- Connect the other end of the optical cable to audio output jack on TV or other device.

- Start playing on the TV
- Press the source input button on the sound bar or remote control to activate the corresponding mode (the OPTICAL mode) to open optical digital input of your sound bar. After successfully connected, the LED display will show **OPTI**. Operate your audio device directly for playback features.
- Press the **VOL +/-** buttons to adjust the volume to your desired level.

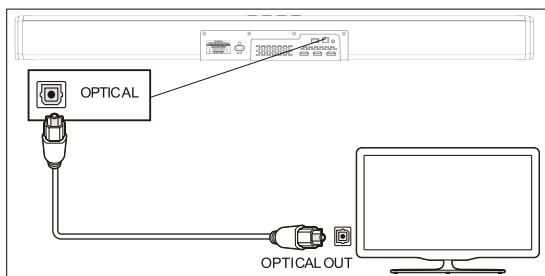

HDMI IN & HDMI (ARC) MODE

Connect to HDMI (ARC) Socket

Some 4K HDR TVs require the HDMI input or picture settings to be set for HDR content reception. For further setup details on HDR display, please refer to the instruction manual of your TV.

Option 1: ARC (Audio Return Channel)

Your Soundbar supports HDMI with Audio Return Channel (ARC). If your TV is HDMI ARC compliant, you can hear the TV audio through your Soundbar by using a single HDMI cable.

1. Use a High Speed HDMI cable, connect HDMI OUT (ARC) on the soundbar to HDMI (ARC) connector
2. Then short-press  button on the sound bar or **INPUT** button on the remote controller to switch to HDMI (ARC) mode. After successfully connected, the LED display will show ARC.
3. Press the **VOL +/-** buttons to adjust the volume to your desired level.
4. If you wish, you can change the audio settings by using the relevant buttons on the remote controller.

Note:

- Your TV must support the HDMI-CEC and ARC function. HDMI-CEC and ARC must be set to be on.
- The setting method of HDMI-CEC and ARC may differ depending on the TV. For details about ARC function, please refer to your TV owner's manual.
- Only HDMI 1.4 compatible cables can support the ARC function.
- The Audio Return Channel (ARC) function enables an HDMI compatible TV to send the audio stream to HDMI OUT of the unit.

Option 2: Standard HDMI

If your TV is not HDMI ARC-compliant, connect your soundbar to the TV through a standard HDMI connection.

- Use an HDMI cable (not included) to connect the soundbar's HDMI OUT socket to the TV's HDMI IN socket.
- Use an HDMI cable (not included) to connect the soundbar's HDMI IN (1 or 2) socket to your external devices (e.g. games consoles, DVD players and Blue-Ray).
- Then short-press  button on the sound bar or on the remote controller to switch to HDMI mode. After successfully connected, the LED display will show **Hd1** or **Hd2**.

Important Note:

When you play Dolby ATMOS signals from Blue-Ray/Set Top Box or other devices to the ATMOS Soundbar, Please follow below steps:

1. Set these devices audio output to be auto or original code.
2. Connect these devices HDMI OUT to the ATMOS Soundbar HDMI IN 1(select HDMI IN 1, so need to press soundbar remote control Input key till LED display HDMI 1) or HDMI IN 2 (select HDMI IN 2, so need to press soundbar remote control Input key till LED display HDMI 2)

3. Connect soundbar HDMI OUT(ARC) to TV HDMI IN.

4. If connect these devices HDMI OUT to TV, then connect TV HDMI ARC to the ATMOS HDMI ARC control! can share with sound bar, but only power on / off, previous / next track, mute and volume of sound bar can be controlled by your TV remote control. or connect these devices Optical to the ATMOS Soundbar, so that the ATMOS soundbar output sound just be Dolby Digital Plus signal as Dolby ATMOS signals bandwidth are big and cannot transfer by Optical or HDMI ARC Channels.

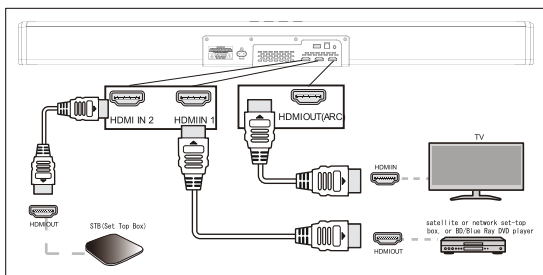

TIPS: (OPTICAL / HDMI ARC / HDMI 1 / HDMI 2 / DOLBY ATMOS)

- While in OPTICAL / HDMI ARC mode, if there's no sound output from the unit and the status LED display flashes, you may need to activate PCM or Dolby Digital Signal output on your source device (e.g. TV, DVD or Blu-ray player).

- The unit may not be able to decode all digital audio formats from the input source. In this case, the unit will mute. This is NOT a defect. Ensure that the audio setting of the input source (e.g. TV, game console, DVD player, etc.) is set to PCM or Dolby Digital (Refer to the user manual of the input source device for its audio setting details) with HDMI 1 / HDMI 2 / HDMI ARC / optical input.
- In HDMI mode, when DOLBY ATMOS audio format is entered, the Soundbar display shows DOLBY ATMOS.
- When DOLBY DIGITAL PLUS audio format is entered, the Soundbar display shows DOLBY SURROUND.

Troubleshooting

REMOTE CONTROL

PROBLEM	CAUSE	REMEDY
The unit cannot be operated using the remote control.	The unit is out of the operating range.	Use the remote control within the operating range.
	The batteries are weak.	Replace with new batteries.
	The remote control sensor of the unit is exposed to direct sunlight or strong lighting.	Adjust the lighting angle, or reposition the unit.
The TV cannot be operated using the TV's remote control.	The unit is blocking the TV's remote control sensor.	Position the unit so that it does not obstruct the TV's remote control sensor.

BLUETOOTH

PROBLEM	CAUSE	REMEDY
The unit cannot be connected to a Bluetooth device.	Bluetooth is not selected as the input source.	Select Bluetooth as the input source.
	The unit is connected to a different Bluetooth device.	Unpair the Bluetooth device that is currently connected, and pair with the desired Bluetooth device.
	The unit is too far away from the Bluetooth device.	Move the Bluetooth device closer to this unit.
	A device emitting electromagnetic waves (such as a microwave oven, a wireless device and so on) may be located nearby.	Do not use this unit near devices that emit electromagnetic waves.
	The Bluetooth device you are using may not support the protocol.	Use a Bluetooth device that supports the protocol.
	The connection profile registered in the bluetooth device may not be functioning correctly for some reason.	Delete the connection profile in the Bluetooth device, and then connect the Bluetooth device to this unit.
No sound can be heard, or the sound cuts off intermittently.	The volume on the Bluetooth device may be too low.	Raise the volume on the Bluetooth device.
	Bluetooth is not selected as the input source.	Select Bluetooth as the input source.
	Playback on the device has not been performed.	Perform playback on the device.
	The sound output on the Bluetooth device may not be set to this unit.	Select this unit as the output destination on the Bluetooth device.
	The connection to the Bluetooth device was cut off.	Connect with the Bluetooth device one more time.
	The unit may be too far away from the Bluetooth device.	Move the Bluetooth device near this unit.
	A device emitting electromagnetic waves (such as a microwave oven, a wireless device and so on) may be located nearby.	Do not use this unit near devices that emit electromagnetic waves.

AUDIO

PROBLEM	CAUSE	REMEDY
No sound.	Another input source is selected.	Select an appropriate input source.
	The mute function is activated.	Cancel the mute function.
	The volume is too low.	Turn up the volume.
	The power cable of the unit is not connected properly.	Make sure that the power cable of the unit is connected to an AC wall outlet securely.
	Input jacks on a playback device are connected.	Connect the input jack on the unit and the output jack on the playback device.
	Signals that the unit cannot play back are being input.	Change the digital audio output setting on the playback device to PCM.
The volume decreases when the unit is turned on.	The automatic volume adjustment function is activated. To prevent excessive loudness, the unit automatically controls its volume within a certain level when the unit is turned on.	Turn up the volume as required.
No surround effect.	The volume is too low.	Turn up the volume.
	The TV or playback device is set to output 2 channel audio (such as PCM) only.	Change the digital audio output setting on the TV or playback device to BitStream.
	Sound is also heard from the TV built-in speakers.	Set the TV volume to minimum.
	The listening position is too close to the unit.	The listening position should be at some distance from the unit.
Noise is heard.	The unit is too close to another digital or high-frequency device.	Move those devices away from the unit.

DOLBY ATMOS®

Manufactured under license from Dolby Laboratories. Dolby, Dolby Audio, Dolby Vision, Dolby Atmos and the double -D symbol are trademarks of Dolby Laboratories.

What is DOLBY ATMOS® ?

Dolby Atmos® transports you from the ordinary into the extraordinary with breathtaking, moving audio that fills your room and flows above and around you.

Dolby Atmos® gives you amazing experience you have never heard before by overhead sound, and all the richness, clarity, and power of Dolby sound.

Using DOLBY ATMOS® :

DOLBY ATMOS® is only available in HDMI IN and HDMI OUT (ARC) mode. For the details of the connection, please refer to "HDMI Connection".

1. To use Dolby Atmos® in HDMI 1 /HDMI 2 / HDMI ARC mode, your TV has to support Dolby Atmos®.
2. Make sure that "No Encoding" is selected for bitstream in the digital audio output of the connected external device (e.g. Blu-ray DVD player, TV etc.).
3. While entering Dolby Atmos / Dolby Digital Plus format, the soundbar will show DOLBY ATMOS / DOLBY SURROUND.

4. Set the audio output sampling rate to 192 kHz if you can adjust it. This sound bar supports 4K Pass through and DOLBY VISION. When you play a disc which supports 4K video signal, the signal can be delivered to your TV.

Note:

- The full Dolby Atmos experience is only available when the Soundbar is connected to the source via a HDMI 2.0 cable.
- The Soundbar will still function when connected via other methods (such as a Digital Optical cable) but these are unable to support all of the Dolby features. Given this, our recommendation is to connect via HDMI, in order to ensure full Dolby support.

Select Equalizer (EQ) Effect

Select predefined sound modes to suit your video or music

Press the EQ button on the remote control to select your desired preset equalizer effects:

Music mode	Enhances the treble and adds greater depth to the music.
Movie mode	Intensifies the bass and enhances the clarity of dialogue.
News mode	Enhances the clarity of voices. Suitable for watching TV shows and news.
3D mode	Enhances background music and full range to be sports effect.

Adjust the Volume

Press Vol+ / Vol- (Volume) to increase or decrease a volume level.

- To mute sound, press Mute.
- To restore the sound, press Mute again or press Vol+ / Vol- (Volume).

Adjust the Bass/Treble Level

Adjust the Bass Level

- Press the **BASS+** / **BASS-** button on the remote control to activate bass level setting.

The display will show **b +5** / **b -5**.

Adjust the Treble Level

- Press the **TREB+** / **TREB-** button on the remote control to activate treble level setting.

The display will show **T +5** / **T -5**.

Features:

Wireless BT/USB/AUX/Optical IN
Triple HDMI - 1 HDMI (ARC) / 2 HDMI IN
Remote control
Wall Mountable
LED Display
Dolby ATMOS / Dolby Audio
Volume/Media Control

Specifications

Output Power : 170 watts
Driver Size : 6.35 cm x 4 + 5.08 cm x 2
Impedance : 8Ω x 4 + 8Ω x 2
Frequency response : 70Hz-20KHz
S/N Ratio : ≥70dB
Separation : ≥36dB
File format support : Mp3 (USB)
Line input : 3.5mm, Optical IN,
HDMI (ARC) & 2 HDMI IN
Max supported
memory size (USB) : 32 GB
BT name : ZEB-JUKE BAR 3850 PRO
DOLBY ATMOS
BT version : 5.0
Product Dimension : 960 x 108 x 81 mm
(W x D x H)
Net. Weight : 3.3 kg

Package contents

Sound Bar	: 1 Unit
Power cord	: 1 Unit
Remote control	: 1 Unit
Input cable	: 1 Unit
HDMI Cable	: 1 Unit
Wall mount bracket with fasteners	: 1 Pair

ISO 9001:2015 Certified Company

www.zebronics.com

