

# Home Theatre System

## Operating Instructions



HT-S20R

## About These Operating Instructions

- The instructions in these Operating Instructions describe the controls on the remote control.
- Some illustrations are presented as conceptual drawings, and may be different from the actual products.
- The default settings are underlined on each feature description.
- Characters in brackets [ ] appear in the front panel display or on the TV screen.

## Installation and Connection

### Connecting a TV with an HDMI Cable and/or Optical Cable

Refer to Startup Guide (separate document).

### Mounting the Bar Speaker and Surround Speakers on a Wall

You can mount the bar speaker and surround speakers on a wall.

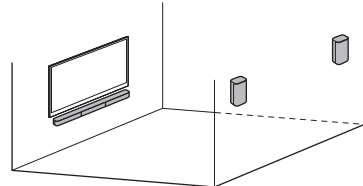

- Notes**
- Prepare screws (not supplied) that are suitable for the wall material and strength. As a plasterboard wall is especially fragile, attach the screws securely in the wall beam, install the speakers horizontally, hung by screws in studs in a continuous flat section of the wall.
  - Have the installation done by a Sony dealer or licensed contractor and pay special attention to safety during the installation.
  - Sony shall not be held responsible for accidents or damage caused by improper installation, insufficient wall strength, improper screw installation or natural disaster, etc.

### Mounting the Bar Speaker on a Wall

- Prepare two screws (not supplied) that are suitable for the wall mount holes on the rear of the bar speaker.

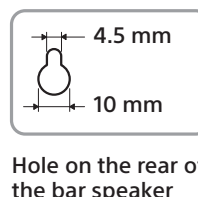
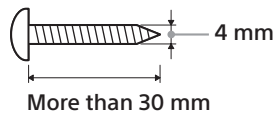

- Stick WALL MOUNT TEMPLATE (supplied) on a wall.

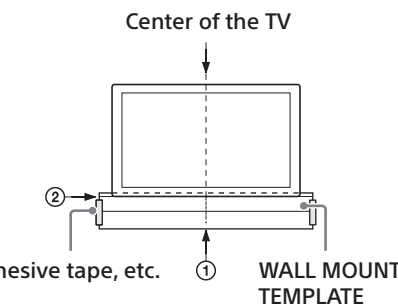

- Align TV CENTER LINE (1) of WALL MOUNT TEMPLATE with the center line of your TV.
- Align TV BOTTOM LINE (2) of WALL MOUNT TEMPLATE with the bottom of your TV, then stick WALL MOUNT TEMPLATE on a wall by using a commercially available adhesive tape, etc.

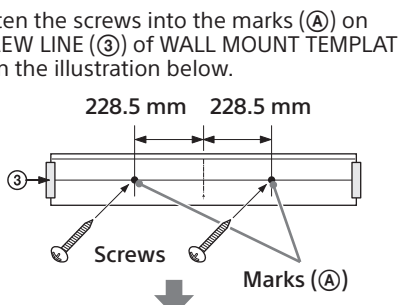

- Fasten the screws into the marks (3) on SCREW LINE (3) of WALL MOUNT TEMPLATE as in the illustration below.

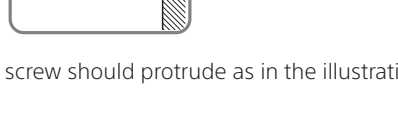

The screw should protrude as in the illustration.

- Remove WALL MOUNT TEMPLATE.
- Hang the bar speaker on the screws.

Align the holes on the rear of the bar speaker with the screws, then hang the bar speaker on the two screws.

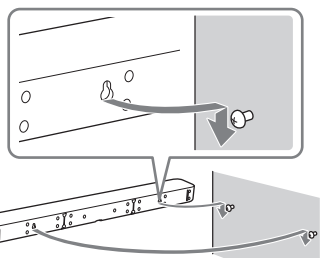

**Note**  
When sticking WALL MOUNT TEMPLATE, smooth it out fully.

### Mounting the Surround Speakers on a Wall

- Prepare a screw (not supplied) for each speaker that is suitable for the wall mount hole on the rear of the surround speaker.

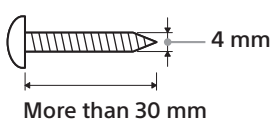

- Fasten the screw into the wall. The screw should protrude as in the illustration.

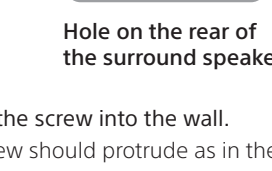

- Hang the surround speaker on the screw.

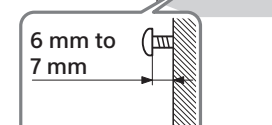

- Align the hole on the rear of the surround speaker with the screw, then hang the surround speaker on the screw.

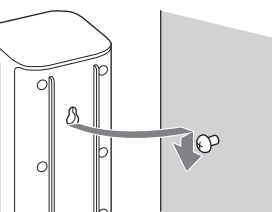

## Parts and Controls

### What's in the Box

- Bar speaker (1)
- Subwoofer (1)
- Surround speaker (2)
- Remote control (1)/ R03 (size AAA) battery (2)
- AC power cord (mains lead) (1) (the shape of the plug differs depending on countries/regions)
- Optical digital cable (1)
- WALL MOUNT TEMPLATE (1)
- Startup Guide
- Operating Instructions (this document)

### WALL MOUNT TEMPLATE (1)

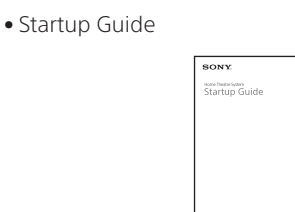
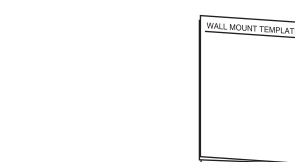

### Operating Instructions (this document)

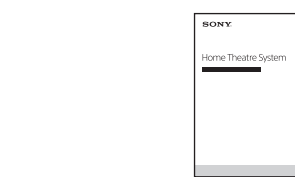

### Rear

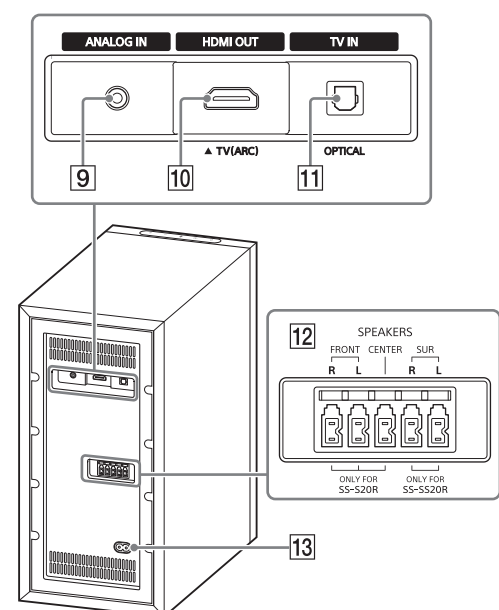

- ANALOG IN jack
- HDMI OUT (TV ARC) jack  
Connect a TV that has an HDMI input jack with an HDMI cable. The system is compatible with Audio Return Channel (ARC). ARC is the function that sends TV sound to an AV device such as the system from the TV's HDMI jack.
- TV IN (OPTICAL) jack
- SPEAKERS jacks
- AC inlet

### Remote Control

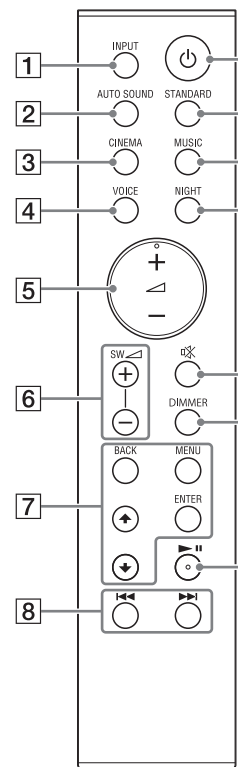

- INPUT**  
Selects the input source. Each time you press INPUT, the input source changes cyclically as follows. [TV] → [ANALOG] → [BT] → [USB]
- AUTO SOUND**  
Selects AUTO SOUND for the sound mode.
- CINEMA**  
Selects CINEMA for the sound mode.
- VOICE**  
Turns on/off the voice mode.
- (volume) +/-**  
Adjusts the volume.
- SW (subwoofer volume) +/-**  
Adjusts the subwoofer volume.
- MENU**  
Turns on/off the menu in the front panel display.  
Selects the menu items. Selects the content on the TV screen for USB playback.
- ENTER**  
Enters the selection. Plays the content that is selected by +/- for USB playback.
- BACK**  
Returns to the previous display. Stops USB playback.
- ◀◀/▶▶ (previous/next)**  
Selects the previous/next track or file. Hold down to search backward or forward for USB playback.
- (power)**  
Turns on the system or sets it to standby mode.
- STANDARD**  
Selects STANDARD for the sound mode.
- MUSIC**  
Selects MUSIC for the sound mode.
- NIGHT**  
Turns on/off the night mode.
- ⊗ (muting)**  
Mutes the sound temporarily. Pressing the button while muting cancels muting.
- DIMMER**  
Adjusts the brightness of the front panel display and BLUETOOTH indicator. Each time you press DIMMER, the brightness setting changes cyclically as follows. [BRIGHT] → [DARK] → [OFF].  
The front panel display and BLUETOOTH indicator light up in the following statuses even if you set the brightness setting to [OFF].  
– When operating the system  
– For 10 seconds after you stop operating the system  
– When displaying the system status, such as mute, Auto Standby, etc.
- ▶▶|| (play/pause)\***  
Plays, pauses, or resumes playback.  
\* The +/- and ▶▶|| buttons have a tactile dot. Use it as a guide during operation.

**About the replacement of batteries for the remote control**  
When the system does not respond by operating with the remote control, replace two batteries with new batteries.  
Use R03 (size AAA) manganese batteries for replacement.

## Listening to Music/Sound

### Listening to a TV

You can listen to TV sound on the system.

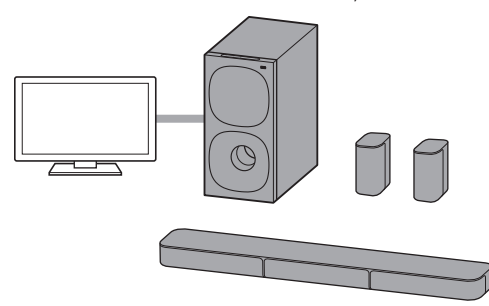

### When Connecting to a TV with an HDMI Cable (ARC) or Optical Digital Cable

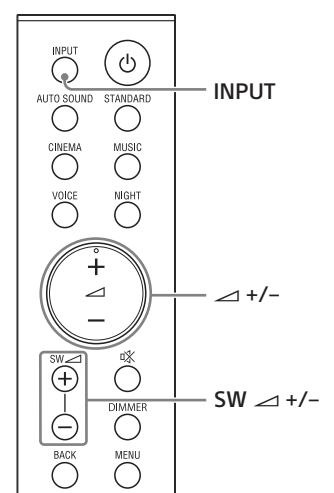

- Press INPUT repeatedly to select [TV] in the front panel display.
- Adjust the volume.  
Adjust the volume by pressing +/- on the remote control.  
Adjust the subwoofer volume by pressing SW +/- on the remote control.

**Notes**  
When you connect the TV to both the HDMI OUT (TV ARC) and TV IN (OPTICAL) jacks, the jack for audio input is selected depending on which audio signal is input first.  
When the input source does not contain much bass sound, such as in TV programs, the bass sound from the subwoofer may be difficult to hear.

### When Connecting to a TV with a Stereo Mini Cable

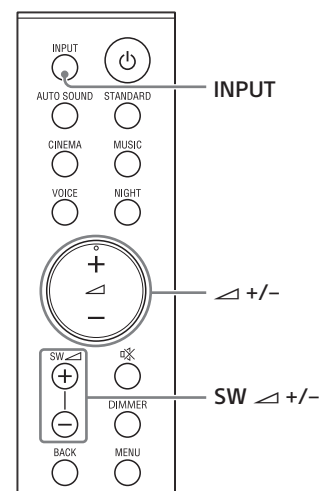

- Press INPUT repeatedly to select [ANALOG] in the front panel display.
- Adjust the volume.  
Adjust the volume by pressing +/- on the remote control.  
Adjust the subwoofer volume by pressing SW +/- on the remote control.

**Note**  
When the input source does not contain much bass sound, such as in TV programs, the bass sound from the subwoofer may be difficult to hear.

**Tip**  
You can also select the input by pressing (input select) on the subwoofer.

### Listening to Music on a USB Device

You can play music files stored on a connected USB device.

- Notes**
- To view the USB content list on the TV screen, make sure you connect the system to the TV using an HDMI cable.
  - Change the input of the TV to the input to which the system is connected.

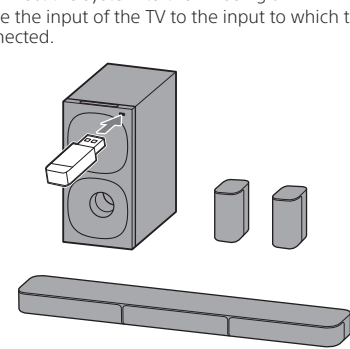

### Listening to Music on a Connected USB Device

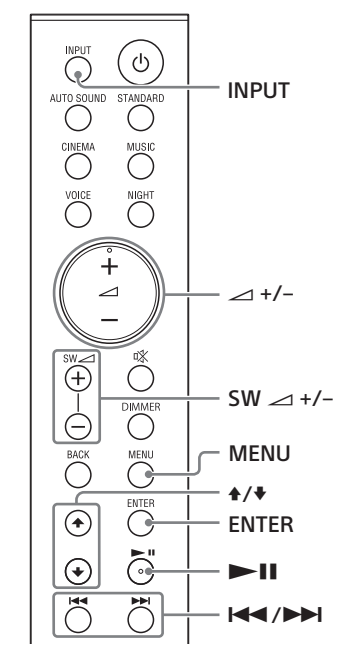

- Connect the USB device to the (USB) port.

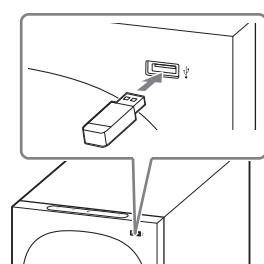

- Press INPUT repeatedly to select [USB] in the front panel display. [READ] appears in the front panel display and the system starts reading data of the USB device. When the reading of data is completed, the USB content list appears on the TV screen. The selected content starts playing.
- Adjust the volume.  
Adjust the volume by pressing +/- on the remote control.  
Adjust the subwoofer volume by pressing SW +/- on the remote control.

**Note**  
When the input source does not contain much bass sound, such as in TV programs, the bass sound from the subwoofer may be difficult to hear.

**To select the play mode**  
You can select the play mode for USB playback, such as repeat play or random play, from the menu.

- Press MENU. The menu item appears in the front panel display.
- Select [USB] - [REPEAT] by using +/-/ENTER.
- Select the play mode by using +/-/ENTER.
  - [OFF]: Repeats off. Plays back all tracks.
  - [ONE]: Repeats one track.
  - [FOLDER]: Repeats all tracks in a current folder.
  - [RANDOM]: Repeats all tracks in a current folder in random order.
  - [ALL]: Repeats all tracks.
- Press MENU to turn off the menu.

### Other operations

To	Do this
Pause or resume playback	Press ▶▶  .
Select the previous or next track	Press ◀◀/▶▶.
Search backward or forward (rewind/fast forward)	Press and hold ◀◀/▶▶.

- Notes**
- Do not remove the USB device during operation. To avoid data corruption or damage to the USB device, turn the system off before connecting or removing the USB device.
  - INVALID USB appears in the front panel display if you connect an unsupported or broken USB device.
  - Depending on the file format, rewind and fast forward may not work.

### Information of USB Device on the TV Screen

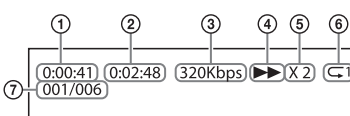

- Playing time
- Total playing time
- Bit rate
- Playback status
- Rewind/fast forward speed
- Play mode
- Selected file index/Total files in the folder

The following messages appear on the TV screen depending on the status of the USB device.

- [File Unsupported] Appears for 2 seconds at the bottom left side when an unsupported file is skipped.
- [Device Not Support] A USB device is not supported. Device inserted is a non-USB device, a bad USB device, or a USB device that has no files on it.
- [No USB] No USB device is inserted.
- [Waiting] The system is searching the USB device.
- [This device is empty] There are no playable files in the USB device.

**Notes**

- Depending on the playback source, some information may not be displayed.
- Depending on the play mode, the information displayed may differ.

### Listening to Music from a Mobile Device with the BLUETOOTH Function

You can listen to music stored on a mobile device such as a smartphone or tablet via a wireless connection by connecting the system and the mobile device with the BLUETOOTH function. When connecting to the mobile device with the BLUETOOTH function, you can operate by simply using the supplied remote control without turning the TV on.

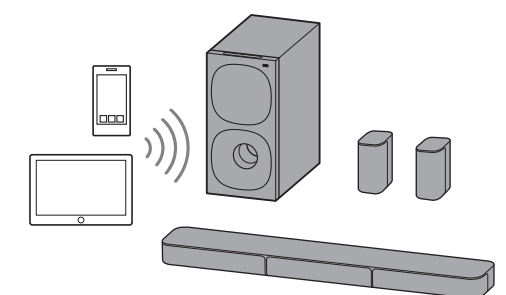

### Pairing with a Mobile Device

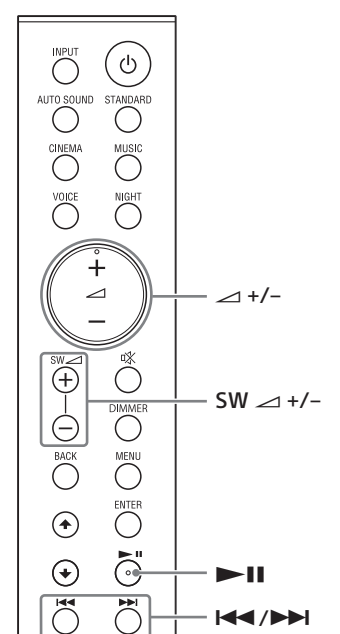

- Press and hold the BLUETOOTH button on the subwoofer for 2 seconds. The system enters the pairing mode and the BLUETOOTH indicator flashes twice repeatedly.

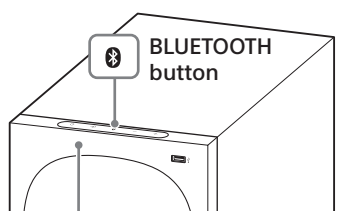

- On the mobile device, search for the system by performing the pairing operation. The list of the BLUETOOTH devices that are searched appears on the screen of the mobile device. For the operation method to pair the BLUETOOTH device to the mobile device, refer to the operating instructions of the mobile device.

- Pair the system and mobile device by selecting "HT-S20R" from the list on the screen of the mobile device. If a passkey is requested, enter "0000."

- Make sure that the BLUETOOTH indicator on the subwoofer lights in blue. A connection between the system and mobile device has been established.

- Start audio playback with the music app on the connected mobile device. Sound is output from the system.

- Adjust the volume.  
Adjust the volume by pressing +/- on the remote control.  
Adjust the subwoofer volume by pressing SW +/- on the remote control.

- ▶▶|| and ◀◀/▶▶ on the remote control can be used for the BLUETOOTH function. (Searching backward or forward by holding down ◀◀/▶▶ does not work.)

**Notes**

- You can pair up to 10 BLUETOOTH devices. If a 11th BLUETOOTH device is paired, the oldest connected device will be replaced by the new one.
- Perform pairing for the second and subsequent mobile devices.
- When the input source does not contain much bass sound, such as in TV programs, the bass sound from the subwoofer may be difficult to hear.

**Tips**

- You can check the connection status of the BLUETOOTH function by checking the BLUETOOTH indicator status.
- While the BLUETOOTH input is being selected, the system enters the pairing mode by pressing the BLUETOOTH button on the subwoofer shortly.

### Listening to Music of the Paired Mobile Device

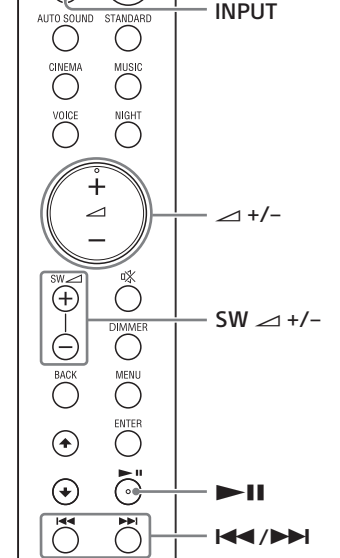

- Turn the BLUETOOTH function of the mobile device to on.
- Press INPUT repeatedly to select [BT] or press the BLUETOOTH button on the subwoofer shortly. The BLUETOOTH indicator flashes and the system automatically reconnects to the BLUETOOTH device it was most recently connected to.
- Make sure that the BLUETOOTH indicator lights in blue. A connection between the system and mobile device has been established.
- Start audio playback with the music app on the connected mobile device. Sound is output from the system.
- Adjust the volume.  
Adjust the volume by pressing +/- on the remote control.  
Adjust the subwoofer volume by pressing SW +/- on the remote control.

- ▶▶|| and ◀◀/▶▶ on the remote control can be used for the BLUETOOTH function. (Searching backward or forward by holding down ◀◀/▶▶ does not work.)

**Note**  
When the input source does not contain much bass sound, such as in TV programs, the bass sound from the subwoofer may be difficult to hear.

## Adjusting the Sound

### Enjoying the Sound Effect that is Tailored to Sound Sources (Sound Mode)

You can easily enjoy pre-programmed sound effects that are tailored to different kinds of sound sources.

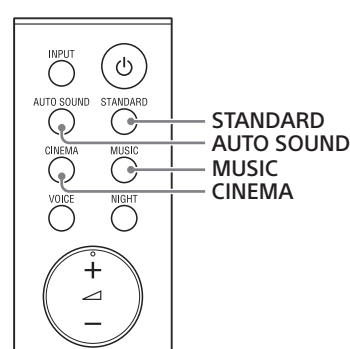

Press AUTO SOUND, CINEMA, MUSIC, or STANDARD to select the sound mode. The selected sound mode appears in the front panel display.

Front panel display	Explanation
[AUTO SOUND]	You can enjoy the sound with Sony-recommended sound mode. The sound mode is automatically optimized according to playback content and function.
[STANDARD]	Sound effects are optimized for the individual source.
[CINEMA]	Sounds are played back with surround effects, and they are realistic and powerful, making them suitable for movies.
[MUSIC]	Sound effects are optimized for listening to music.

### Making Dialogs Clearer (VOICE)

You can make dialogs clearer by setting the voice mode.

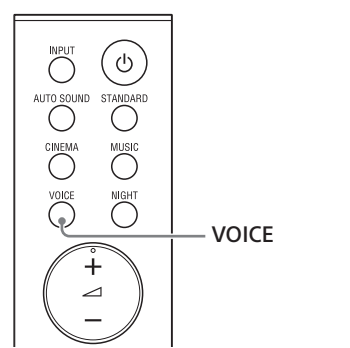

Press VOICE to set the function to on or off.

Front panel display	Explanation
[Vo.ON]	The sound of voice is emphasized.
[Vo.OFF]	Off.

### Enjoying Clear Sound with Low Volume at Midnight (NIGHT)

You can compress sound in accordance with the information contained in the content by setting the night mode to on. Sound is output at low volume with minimum loss of fidelity and clarity of dialog.

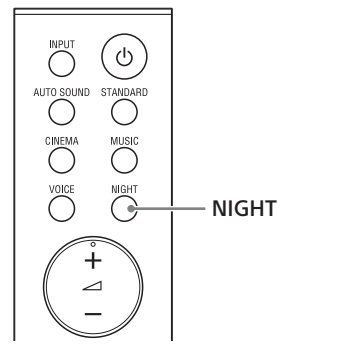

Press NIGHT to set the function to on or off.

Front panel display	Explanation
[N.ON]	The sound is compressed in accordance with the information contained in the content.
[N.OFF]	Off.

**Note**  
When you turn the system off, the night mode is set to off automatically.

### Checking the Current Sound Settings

You can check the settings of the sound, night, and voice modes and current stream information.

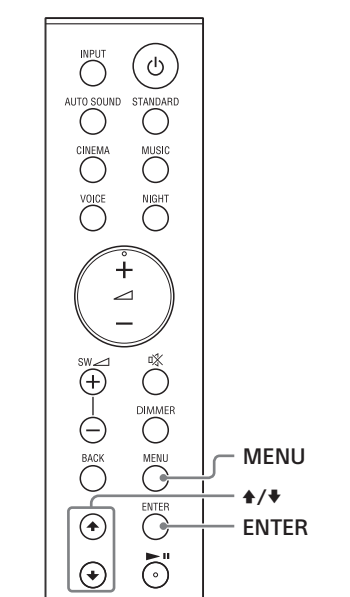

- Press MENU to turn on the menu in the front panel display.
- Press +/- to select [CURRENT STATUS], then press ENTER.
- Press +/- repeatedly to select the item you want. The current setting appears in the following order. Sound mode → Voice mode → Night mode → Stream Information. The current setting appears in the reverse order by pressing +/-.
- Press MENU to turn off the menu.



