



OWNER'S MANUAL

AIR CONDITIONER



Read this owner's manual thoroughly before operating the appliance and keep it handy for reference at all times.

TYPE: WALL MOUNTED

EN ENGLISH



MFL71686913
Rev.01_092922



QR code for
Installation manual

www.lg.com

Copyright © 2022 LG Electronics Inc. All Rights Reserved

TABLE OF CONTENTS

This manual may contain images or content different from the model you purchased.

This manual is subject to revision by the manufacturer.

SAFETY INSTRUCTIONS	3
IMPORTANT SAFETY INSTRUCTIONS	4
OPERATION	13
Notes for Operation	13
Parts and Functions.....	13
Wireless Remote Control.....	14
Restarting the Air Conditioner Automatically	18
Using the Mode Function.....	18
Using the VIRAAT Function	20
Using the Fan Speed Function	20
Using the Air Flow Direction Function.....	21
Setting the On/Off Timer	21
Using the Sleep Function (Optional).....	22
Using the Simple Timer Function (Optional).....	23
Using the Mute Function (Optional).....	23
Using the Energy Display Function (Optional).....	23
Using the Light Off Function (Optional)	24
Using the Comfort Air Function (Optional).....	24
Using the AP(AC) + 4 Function (Optional).....	24
Using Special Functions	26
SMART FUNCTIONS	27
LG ThinQ Application.....	27
Smart Diagnosis	29
MAINTENANCE.....	30
Clean the Air Filter	32
Clean the Micro Dust, Triple and Allergy Filter (Optional).....	33
TROUBLESHOOTING	34

SAFETY INSTRUCTIONS

EN

The following safety guidelines are intended to prevent unforeseen risks or damage from unsafe or incorrect operation of the appliance. The guidelines are separated into 'WARNING' and 'CAUTION' as described below.

 This symbol is displayed to indicate matters and operations that can cause risk. Read the part with this symbol carefully and follow the instructions in order to avoid risk.

WARNING

This indicates that the failure to follow the instructions can cause serious injury or death.

CAUTION

This indicates that the failure to follow the instructions can cause the minor injury or damage to the product.

The following symbols are displayed on indoor and outdoor units.

 This symbol indicates that this appliance uses a flammable refrigerant. If the refrigerant is leaked and exposure to an external ignition source, there is a risk of fire.

 This symbol indicates that the Operation Manual should be read carefully.

 This symbol indicates that a service personnel should be handling this equipment with reference to the Installation Manual.

 This symbol indicates that information is available such as the Operating Manual or Installation Manual.

IMPORTANT SAFETY INSTRUCTIONS

WARNING

To reduce the risk of explosion, fire, death, electric shock, injury or scalding to persons when using this product, follow basic precautions, including the following:

Children in the Household

This appliance is not intended for use by persons (including children) with reduced physical, sensory or mental capabilities, or lack of experience and knowledge, unless they have been given supervision or instruction concerning use of the appliance by a person responsible for their safety. Children should be supervised to ensure that they do not play with the appliance.

Installation

- Do not install the air conditioner on an unstable surface or in a place where there is danger of it falling.
- Contact an authorized service center when installing or relocating the air conditioner.
- Install the panel and the cover of the control box safely.

- Do not install the air conditioner in a place where flammable liquids or gases such as gasoline, propane, paint thinner, etc., are stored.
- Make sure that the pipe and the power cable connecting the indoor and outdoor units are not pulled too tight when installing the air conditioner.
- Use standard circuit breaker and fuse that conform to the rating of the air conditioner.
- Do not input air or gas into the system except with the specific refrigerant.
- Use non-flammable gas (nitrogen) to check for leak and to purge air; using compressed air or flammable gas may cause fire or explosion.
- The indoor/outdoor wiring connections must be secured tightly, and the cable should be routed properly so that there is no force pulling the cable from the connection terminals. Improper or loose connections can cause heat generation or fire.
- Install dedicated electric outlet and circuit breaker before using the air conditioner.
- Do not connect the ground wire to a gas pipe, a lightning rod, or a telephone ground wire.
- Keep any required ventilation openings clear of obstruction.
- Means for disconnection must be incorporated in the fixed wiring in accordance with the wiring rules.
- Do not install the unit in potentially explosive atmospheres.

Operation

- Be sure to use only those parts listed in the service parts list. Never attempt to modify the equipment.
- Make sure that children do not climb on or hit the outdoor unit.
- Dispose of the batteries in a place where there is no danger of fire.
- Use only the refrigerant specified on the air conditioner label.

- Cut off the power supply if there is any noise, smell, or smoke coming from the air conditioner.
- Do not leave flammable substances such as gasoline, benzene, or thinner near the air conditioner.
- Contact an authorized service center when the air conditioner is submerged by flood waters.
- Do not use the air conditioner for an extended period of time in a small place without proper ventilation.
- In the event of a gas leak (such as Freon, propane gas, LP gas, etc.) ventilate sufficiently before using the air conditioner again.
- Be sure to ventilate sufficiently when the air conditioner and a heating appliance such as a heater are used simultaneously.
- Do not block the inlet or outlet of air flow.
- Do not insert hands or other objects through the air inlet or outlet while the air conditioner is operating.
- Make sure that the power cable is neither dirty, loose, nor broken.
- Never touch, operate, or repair the air conditioner with wet hands.
- Do not place any objects on the power cable.
- Do not place a heater or other heating appliances near the power cable.
- Do not modify or extend the power cable. Scratches or peeling insulation on the power cables may result in fire or electric shock, and should be replaced.
- Cut off the power supply immediately in the event of a blackout or a thunderstorm.

- Take care to ensure that power cable could not be pulled out or damaged during operation.
- Do not touch refrigerant pipe, water pipe and any internal parts while the unit is operating or immediately after operation.

Maintenance

- Do not clean the appliance by spraying water directly onto the product.
- Before cleaning or performing maintenance, disconnect the power supply and wait until the fan stops.

Technical Safety

- Installation or repairs made by unauthorized persons can pose hazards to you and others.
- Any person who is involved with working on or breaking into a refrigerant circuit should hold a current valid certificate from an industry-accredited assessment authority, which authorizes their competence to handle refrigerants safely in accordance with an industry recognized assessment specification.
- Servicing shall only be performed as recommended by the equipment manufacturer. Maintenance and repair requiring the assistance of other skilled personnel shall be carried out under the supervision of the person competent in the use of flammable refrigerants.
- The information contained in the manual is intended for use by a qualified service technician who is familiar with the safety procedures and equipped with the proper tools and test instruments.
- Failure to read and follow all instructions in this manual can result in equipment malfunction, property damage, personal injury and/or death.

- The appliance shall be installed in accordance with national wiring regulations.
- When the power cord is to be replaced, the replacement work shall be performed by authorized personnel using only genuine replacement parts.
- This appliance must be properly grounded to minimize risk of electric shock.
- Do not cut or remove the grounding prong from the power plug.
- Attaching the earth wire to the power outlet cover screw does not ground the appliance unless the cover screw is metal, uninsulated, and the power outlet is grounded through house wiring.
- If you have any doubt whether the air conditioner is properly grounded, have the power outlet and circuit checked by a qualified electrician.
- The refrigerant and insulation blowing gas used in the appliance require special disposal procedures. Consult a service agent or a similarly qualified person before disposing of them.
- If the supply cord is damaged, it must be replaced by the manufacturer, its service agent or similarly qualified person in order to avoid a hazard.
- The appliance shall be stored in a well-ventilated area where the room size corresponds to the room area as specified for operation.
- The appliance shall be stored in a room without continuously operating open flames (for example an operating gas appliance) and ignition sources (for example an operating electric heater).
- The appliance shall be stored so as to prevent mechanical damage from occurring.

⚠ CAUTION

To reduce the risk of minor injury to persons, malfunction, or damage to the product or property when using this product, follow basic precautions, including the following:

Installation

- Do not install the air conditioner in an area where it is directly exposed to sea wind (salt spray).
- Install the drain hose properly for the smooth drainage of water condensation.
- Exercise caution when unpacking or installing the air conditioner.
- Do not touch the leaking refrigerant during installation or repair.
- Transport the air conditioner with two or more people or use a forklift.
- Install the outdoor unit such that it is protected from direct sunlight. Do not place the indoor unit in a place where it is directly exposed to sunlight via the windows.
- Safely dispose of packing materials such as screws, nails, plastic bag or batteries using proper packaging after installation or repair.
- Install the air conditioner in a place where the noise from the outdoor unit or the exhaust fumes will not inconvenience the neighbors. Failure to do so may result in conflict with the neighbors.

Operation

- Remove the batteries if the remote control is not to be used for an extended period of time.

- Make sure that the filter is installed before operating the air conditioner.
- Be sure to check if there is a refrigerant leak after installing or repairing the air conditioner.
- Do not place any object on the air conditioner.
- Never mix different types of batteries, or old and new batteries for the remote control.
- Do not let the air conditioner run for a long time when humidity is very high or when a door or a window has been left open.
- Stop using the remote control if there is a fluid leak in the battery. If your clothes or skin are exposed to the leaking battery fluid, wash off with clean water.
- Do not expose people, animals, or plants to the cold or hot wind from the air conditioner for extended periods of time.
- If the leaking battery fluid has been swallowed, rinse the inside of the mouth thoroughly and consult a doctor.
- Do not drink the water drained from the air conditioner.
- Do not use the product for special purposes, such as preserving foods, works of art, and etc. It is an air conditioner for consumer purposes, not a precision refrigeration system. There is risk of damage or loss of property.
- Do not recharge or disassemble the batteries.
- This product is for home use only and using it for business purposes or in an unconventional environment may invalidate the warranty and make the product ineligible for repair.

Maintenance

- Never touch the metal parts of the air conditioner when removing the air filter.
- Use a sturdy stool or ladder when cleaning, maintaining, or repairing the air conditioner at a height.
- Never use strong cleaning agents or solvents when cleaning the air conditioner or spray water. Use a smooth cloth.
- To clean the interior, contact an authorized service center or dealer. Using harsh detergents may cause corrosion or damage to the unit.

Disposal of Your Old Appliance (as per e-waste Rules)



- When this crossed out wheeled bin symbol is depicted on the product and its operator's manual, it means is covered by the E-Waste (Management) Rules, 2016 and it's subsequent amendment from time to time and are meant to be recycled, dismantled, refurbished or disposed off.
- Do's
 - a. The product is required to be handed over only to the authorized recycler for disposal.
 - b. Keep the product in isolated area, after it becomes non-functional/unrepairable so as to prevent its accidental breakage.
- Don't
 - a. The product should not be opened by the user himself/herself, but only by authorized service personnel.
 - b. The product is not meant for re-sale to any unauthorized agencies/scrap dealer/kabariwalah.
 - c. The product is not meant for mixing into household waste stream.
 - d. Do not keep any replaced spare part(s) from the product in exposed area.
- Any disposal through unauthorized agencies/person will attract action under Environment (Protection) Act 1986.
- Hazards of improper handling or accidental breakage.
 - a. If batteries are disposed incorrectly, it can greatly harm the environment. The chemical byproducts are hazardous. The metals and chemicals found in batteries can mix into soil which may be hazardous to humans, plants and animals. If thrown in fire, they can cause blast and release toxic gases which may be harmful for health.
 - b. The refrigerant used can be combustible at low pressure. The potential health effects of over exposure is dizziness, headache and heart irregularities.
- This product is complied with the requirement of Hazardous Substances as specified under Rule 16 (1) & (3) of the E-Waste (Management) Rules, 2016 and it's subsequent amendment from time to time.
- To locate a nearest collection centre or call for pick-up (limited area only) for disposal of this appliance, please contact Toll Free No. 1800-180-9999 for details. All collection centre and pick up facilities are done by third parties with LG Electronics India Pvt. Ltd. Merely as a facilitator. For more detailed information, please visit :<http://www.lge.com/in>

अपने पुराने निपटान के उपकरण (ई-अपशिष्ट नियम के अनुसार)



- जब इस काटे गए पहिये वाले बिन का चिन्ह किसी उपकरण और इसके ओपरेटर की पुस्तिका के साथ संलग्न होता है तो इसका मतलब है कि इसे "ई-अपशिष्ट" (प्रबंधन) नियम, २०१६ के अंतर्गत सम्मिलित किया गया है और समय समय पर संशोधित किया जाता है, और इसे पुनर्नवीनीकरण, नवीनीकरण, विघटन और निपटान के लिए बनाया गया है ।
- करें
 - क. उपकरण को सिर्फ अधिकृत पुनः नवीनीकरणकर्ता को ही निपटारण करने हेतु हस्तांतरित करें ।
 - ख. जब उपकरण कार्यरत न हो इसे अलग क्षेत्र में रखें ताकि उपकरण से होने वाली दुर्घटनाओं से बचा जा सके ।
- न करें
 - क. इस उपकरण को स्वयं/खुद नहीं खोलना चाहिए ! उपकरण को केवल अधिकृत अधिकारी के द्वारा ही खोला जाना चाहिए ।
 - ख. इस उपकरण को पुनः बिक्री के लिए किसी भी कबाड़ीवाला / भंगारवाला / अनाधिकृत संस्था को न दें ।
 - ग. इस उपकरण को किसी घरेलू अपशिष्ट सामान के साथ मिलाकर न रखें ।
 - घ. उपकरण के बदले हुए या आंतरिक पुरजो को खुले क्षेत्र में न रखें ।
- यदि किसी अनाधिकृत विभाग या व्यक्ति के द्वारा निपटारण किया जाता है तो यह पर्यावरण (सुरक्षा) धारा १९८६ के अंतर्गत आता है ।
- दुर्घटना टूट / फूट अव्यवस्थित रख-रखाव से बचें ।
 - क. यदि बैटरियों का निपटारण अशुद्ध रूप से कर रहे हैं, तो यह वातावरण को बहुत नुकसान पहुँचा सकता है । रासायनिक उपकरण खतरनाक होते हैं। जो रसायन और धातु बैटरियों में पाए जाते हैं। इसे मिट्टी में मिलाने पर यह मनुष्यों, पौधों और पशुओं दसलिए खतरनाक हो सकती है। यदि इसे आग में फेंकते हैं तो ये विस्फोट कर सकती है और ये जहरीली गैस दे सकती है जो स्वास्थ्य के लिए हानिकारक है.
 - ख. रेफ्रिजरेट कम दबाव पर दहनशील हो सकती है तथा इससे स्वास्थ्य पर दुष्प्रभाव पड़ सकता है जैसे चक्कर आना, सर दर्द और हृदय गति रुकना।
- यह उत्पाद खतरनाक पदार्थों के लिए बनाये गए नियमांक १६ (१) और (३), ई-अपशिष्ट (प्रबंधन) नियम, २०१६ के कानून का पालन करता है और समय समय पर संशोधित किया जाता है.
- उपरोक्त पदार्थों के निपटारण के लिए नजदीकी निपटारण संस्थान (संकीर्ण क्षेत्र) में कॉल करें। अधिक जानकारी के लिए हमारे टोल फ्री नंबर **1800-180-9999** पर कॉल करें. सभी संग्रहण केंद्र व पिक-अप की सुविधाएं किसी थर्ड - पार्टी जो "LG Electronics India Pvt. Ltd." को अपनी सेवाएं प्रदान कर रही हों, उससे करवाएं । ज्यादा जानकारी के लिए देखें वेब:साईट - <http://www.lge.com/in>

Notes for Operation

Suggestion for Energy Saving

- Do not over-cool the space. This may be harmful for your health and may consume more electricity.
- Block sunlight with blinds or curtains while you are operating the air conditioner.
- Keep doors or windows closed tightly while you are operating the air conditioner.
- Adjust the direction of the air flow vertically or horizontally to circulate indoor air.
- Speed up the fan to cool or warm indoor air quickly, within a short period of time.
- Open windows regularly for ventilation. The indoor air quality may deteriorate if the air conditioner is used for long durations.
- Clean the air filter once every 2 weeks. Dust and impurities collected in the air filter may block the air flow or reduce the unit performance.

Parts and Functions

Indoor Unit

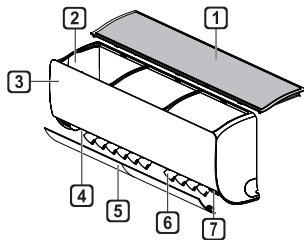

- 1 Air Filter
- 2 Air Intake
- 3 Front Cover
- 4 Air Outlet
- 5 Air Deflector (Horizontal Vane)
- 6 Air Deflector (Vertical Louver)
- 7 On/Off Button

Outdoor Unit

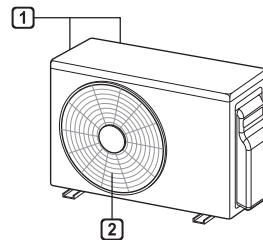

- 1 Air Intake Vents
- 2 Air Outlet Vents

NOTE

- The number and location of parts may vary according to the model of the air conditioner.
- The feature may be changed according to the type of model.

Wireless Remote Control

Inserting Batteries

If the display screen of the remote control begins to fade, replace the batteries. Insert AAA (1.5 V) batteries before using the remote control.

- 1 Remove the battery cover.

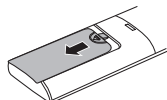

- 2 Insert the new batteries and make sure that the + and - terminals of the batteries are installed correctly.

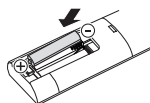

Installing the Remote Control Holder (Optional)

To protect the remote control, install the holder where there is no direct sunlight.

- 1 Choose a safe and easily accessible location.
- 2 Fix the holder by fastening 2 screws firmly with a screwdriver.

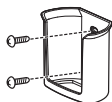

Operating Method

Point the remote control towards the signal receiver at the right side of the air conditioner to operate it.

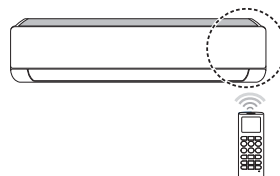



NOTE

- The remote control may operate other electronic devices if it is directed towards them. Make sure to point the remote control towards the air conditioner signal receiver.
- For proper operation, use a soft cloth to clean the signal transmitter and receiver.
- In case of a function not provided in the product, no buzzer sound occurs from the product when a button for such function on the remote control is pressed except for Air Flow Direction (Swing), Energy Display (kW(3s)), Air Purification function (Z, O).

Setting the Current Time

- 1 Insert batteries (reinsert a battery if already inserted/or use the reset button).
 - The icon below blinks at the bottom of the display screen.



- 2 Press  or  button to select the minutes.
- 3 Press **Set/Cancel** button to finish.

NOTE

- The On/Off Timer is available after setting the current time.

Using the °C/°F Conversion Function (Optional)

This function changes unit between °C and °F

- Press and hold  button about 5 seconds.

Operating the Air Conditioner without the Remote Control

You can use the **ON/OFF** button of the indoor unit to operate the air conditioner when the remote control is unavailable.

- 1 Open the front cover (Type2) or horizontal vane (Type1).
- 2 Press the **ON/OFF** button.

Type1

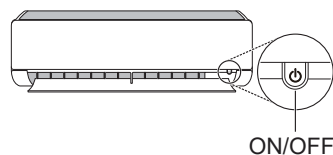

Type2

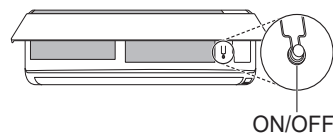











NOTE

- The stepping motor may be broken, if the horizontal vane opens rapidly.
- The fan speed is set to high.
- The feature may be changed according to the type of model.
- The temperature cannot be altered when using this emergency **ON/OFF** button.
- For cooling-only models, the temperature is set to 24 °C
- For cooling & heating models, the temperature is set from 24 °C

Using Wireless Remote Control

You can operate the air conditioner more conveniently with the remote control.

1 Button	2 Display Screen	Description
	-	To turn on/off the air conditioner.
 Temp. 	88 °C	To adjust the desired room temperature in cooling, heating or AI Plus Convertible / AI Convertible mode.
Mode		To select the cooling mode.
		To select the heating mode.
		To select the dehumidification mode.
		To select the fan mode.
*6-in-1/ VIRAAT	HC	To change room temperature quickly.
Fan Speed		To adjust the fan speed.
 		To adjust the air flow direction vertically or horizontally.

NOTE

- * * buttons may be changed according to the type of model.

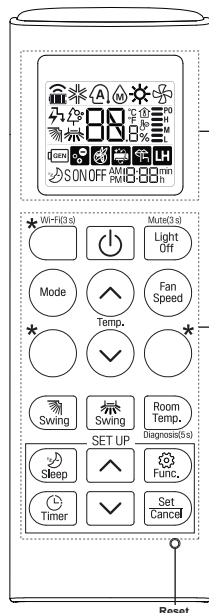

1 Button	2 Display Screen	Description
	SONOFF	To turn on/off air conditioner automatically at desired time.
Set/Cancel	-	To set/cancel the special functions and timer.
	-	To adjust time.
Light Off	-	Turn Indoor unit display On or OFF.
Room Temp.		To display the room temperature.
*°C↔°F (5 s)	°C °F	To change unit between °C and °F
*Comfort Air		To adjust the air flow to deflect wind.
*kW(3 s)	-	To set whether or not to display information regarding energy.
*6-in-1/ AC + 4	88 %	To bring the effect of the power saving.
	AC	To select AI Convertible mode.
*6-in-1/ AP + 4 (Wi-Fi Model)	88 %	To bring the effect of the power saving.
	AP	To select AI Plus Convertible mode.
*Comfort Sleep		To make a comfortable sleeping environment.
		To set the sleeping mode automatically.
Diagnosis (5 s)	-	To conveniently check maintenance information of a product.
Wi-Fi(3 s)	-	To prepare settings for a Wi-Fi connection.
Mute(3 s)	-	To turn on/off buzzer sound.
		The Ion generator uses millions of ions to help improve indoor air quality.
		To remove moisture generated inside the indoor unit.
Reset	-	To initialize the remote control settings.

NOTE

- Some functions may not be supported, depending on the model.
- * buttons may be changed according to the type of model.
- Press the **Set/Cancel** button to operate the selected **Func.**.

Restarting the Air Conditioner Automatically

When the air conditioner is turned on again after a power failure, this function restores the previous settings.

Disabling Auto Restart

- 1 Open the front cover (Type2) or horizontal vane (Type1).
- 2 Press the **ON/OFF** button and hold it for 6 seconds, then the unit will beep twice and the lamp will blink twice 4 times.
 - To re-enable the function, press the **ON/OFF** button and hold it for 6 seconds. The unit will beep twice and the lamp will blink 4 times.

Type1

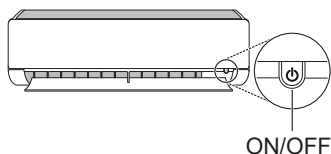

Type2

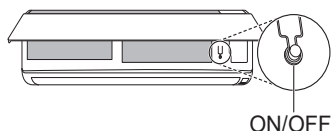

NOTE

- The feature may be changed according to the type of model.
- If you press and hold the **ON/OFF** button for 3 – 5 seconds, instead of 6 seconds, the unit will switch to the test operation. In the test operation, the unit blows out strong cooling air for 18 minutes and then returns to factory default settings.

Using the Mode Function

This function allows you to select the desired function.

Cooling Only Model

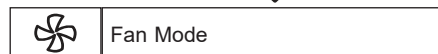
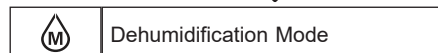

Cooling & Heating Model

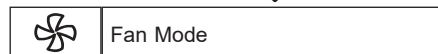
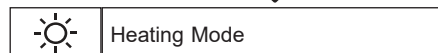
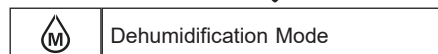

Cooling Mode

- 1 Turn the appliance on.
- 2 Press **Mode** button repeatedly to select the Cooling Mode.
 - ❄️ is displayed on the display screen.
- 3 Press or button to set the desired temperature.

NOTE

- Default temperature will be minimum 24 °C (in cooling cycle), when operated with remote control except power failure/power switched off.

Dehumidification Mode (Monsoon Operation)



This mode removes excess moisture from a highly humid environment or during the rainy season, in order to prevent mildew from setting in. This mode adjusts the room temperature and the fan speed automatically to maintain the optimal level of humidity.

- 1 Turn the appliance on.
- 2 Press **Mode** button repeatedly to select the Dehumidification Mode.
 -  is displayed on the display screen.

NOTE

- In this mode you cannot adjust the room temperature, it is adjusted automatically.
- The room temperature is not displayed on the display screen.
- In the dehumidification mode, compressor and indoor fan may not operate when the room temperature is below 24 °C

Heating Mode (Optional)

- 1 Turn the appliance on.
- 2 Press **Mode** button repeatedly to select the Heating Mode.
 -  is displayed on the display screen.
- 3 Press  or  button to set the desired temperature.

NOTE

-  will be displayed on the indoor unit when defrosting is operating.
- Furthermore, this indication will be displayed on the indoor unit:
 - When preheating is operating.
 - When the room temperature has been reached to the set temperature.

Fan Mode

This mode only circulates the indoor air without changing the room temperature.

- 1 Turn the appliance on.
- 2 Press **Mode** button repeatedly to select the Fan Mode.
 -  is displayed on the display screen.
- 3 Press **Fan Speed** button to adjust the fan speed.

NOTE

-  or  will be displayed on the indoor unit when fan mode is operating.

Using the VIRAAT Function Changing Room Temperature Quickly

This function allows you to cool indoor air quickly during the summer.

- Cooling Only model : The VIRAAT function is available with Cooling, Dehumidification, Fan and Air Purification function.

- 1 Turn the appliance on.
- 2 Press **Mode** button repeatedly to select the desired mode.
- 3 Press **6-in-1/VIRAAT** button.

-  is displayed on the display screen.





NOTE

- In VIRAAT, strong air blows out.
- This function may operate differently from the remote control display.
- In VIRAAT, auto swing is automatically set.
- If you want to cancel the auto swing setting, Press  button.

Using the Fan Speed Function

Adjusting the Fan Speed

- Press **Fan Speed** button repeatedly to adjust the fan speed.

Display Screen	Speed
	High
	Medium - High
	Medium
	Medium - Low
	Low
-	Natural Wind

NOTE

- The fan speed of Natural Wind adjusts automatically.

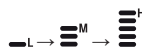



- The fan speed icons are displayed on some indoor units.

F 1 → F 2 → F 3 → F 4 → F 5



- Indoor unit display is displayed only 5 seconds and return to the setting temperature on some models.

Using the Air Flow Direction Function

This function adjusts the direction of the air flow vertically (horizontally).

- Press   button repeatedly and select the desired direction.
 - Select  to adjust the direction of the air flow automatically.

NOTE

- Adjusting the air flow direction horizontally may not be supported, depending on the model.
- Adjusting the air deflector arbitrarily may cause product failure.
- If you restart the air conditioner, it starts to operate with the previously set direction of air flow, so the air deflector may not match the icon displayed on the remote control. When this occurs, press  or  button to adjust the direction of the air flow again.
- This function may operate differently from the remote control display.

Setting the On/Off Timer



This function sets the air conditioner to turn on/off automatically at desired time.

On/Off Timer can be set together.

Setting the On Timer

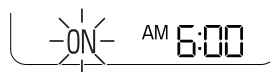
- 1 Press  button repeatedly.
 - The icon below blinks at the bottom of the display screen.



- 2 Press  or  button to select the minutes.
- 3 Press **Set/Cancel** button to finish.
 - After setting the timer, current time and **ON** icon are displayed on the display screen indicating that the desired time is set.

Canceling the On Timer

- 1 Press  button repeatedly.
 - The icon below blinks at the bottom of the display screen.

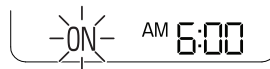



- 2 Press **Set/Cancel** button to cancel the setting.

Setting the Off Timer

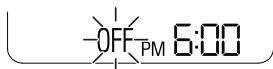
- 1 Press  button repeatedly.
 - The icon below blinks at the bottom of the display screen.



- 2 Press  or  button to select the minutes.
- 3 Press **Set/Cancel** button to finish.
 - After setting the timer, current time and OFF icon are displayed on the display screen indicating that the desired time is set.

NOTE

- This function is disabled when you set Simple Timer.

Canceling the Off Timer

- 1 Press  button repeatedly.
 - The icon below blinks at the bottom of the display screen.

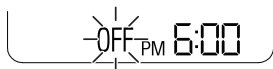

- 2 Press **Set/Cancel** button to cancel the setting.

Canceling the Timer Setting



- Press **Set/Cancel** button to cancel all timer settings.

Using the Sleep Function (Optional)

This function turns off the air conditioner automatically when you go to sleep.

- 1 Turn the appliance on.
- 2 Press  button.
 - The icon below blinks at the bottom of the display screen.



- 3 Press  or  button to select the hour (up to 7 hours).
- 4 Press **Set/Cancel** button to finish.
 -  is displayed on the display screen.

NOTE



-  is displayed on some indoor units.
- Indoor unit display is displayed from 1H to 7H for 5 seconds, after that display will be OFF.
- In the Cooling and Dehumidification Mode, the temperature increases by 1 °C after 30 minutes and additional 1 °C after another 30 minutes for a more comfortable sleep.
- The temperature increases up to 2 °C from the preset temperature.
- Although the remark for fan speed on the display screen may be changed, the fan speed is adjusted automatically.

Using the Simple Timer Function (Optional)

This function turns off the air conditioner automatically when you go to sleep.

- 1 Turn the appliance on.
- 2 Press  button repeatedly.
 - The icon below blinks at the bottom of the display screen.



- 3 Press  or  button to select the hour (up to 7 hours).
- 4 Press **Set/Cancel** button to finish.
 - **S** is displayed on the display screen.

NOTE

- This function is disabled when you set Off Timer.

Using the Mute Function (Optional)

This function can turn on/off the buzzer sound to notify you when you set or change the function of the air conditioner.

- 1 Turn the appliance on.
- 2 Press  button and hold it about 3 seconds.
 - Each time the button is pressed, the function turns on/off.

NOTE

- When the Mute is set, 'OF' appears for a moment on the indoor unit display and the buzzer sound turned off.

Using the Energy Display Function (Optional)

This function displays the amount of electricity generated on the indoor display as the product operates.

Display the Current Energy Usage

- 1 Turn the appliance on.
- 2 Press  button and hold it about 3 seconds.
 - The instantaneous power consumption (**03** or **88**) is displayed for a while on some indoor units.

Display the Cumulative Energy Usage (Optional)

- 1 Turn the appliance on.
- 2 Press  button and hold it about 3 seconds twice.
 - The cumulative power consumption (**88**) is displayed for a while on some indoor units.

NOTE

- The unit of the displayed value is kW.
- It is not displayed on the wireless remote control.
- **kW** refers to instantaneous power consumption.
- **kWh** refers to cumulative power consumption.
- If it is more than 99 kWh, which is the range of expression, maintain it as 99 kWh.
- Power off resets its value.
- Display wattage under 10 kW(h) with 0.1 kW(h) unit, and display one over 10 kW(h) with 1 kW(h) unit.
- The actual power may differ from the power displayed.

Using the Light Off Function (Optional)

Display Screen Brightness

You can set the brightness of the indoor unit display screen.

- Press **Light Off** button.



NOTE

- Turn on/off the Display screen.
- If the brightness of an indoor appliance's display is set to OFF, pressing a button on the remote control automatically turns the display on for 5 seconds.
- This function may operate differently, depending on the model.



Using the Comfort Air Function (Optional)

Comfort Vane Operation

This function conveniently sets the vane to a preset position to deflect the supply air away from blowing directly onto the occupants in the room.

- 1 Turn the appliance on.
- 2 Press **Comfort Air** button repeatedly and select the desired direction.
 -  or  is displayed on the display screen.









NOTE

-  or  is displayed on some indoor units.
- This function is disabled when you press **Mode** or **6-in-1/VIRAAT** button.
- This function is disabled and auto swing of vertical direction is set up when you press  button.
- When this function is off, the horizontal vane operates automatically depending on the set mode.

Using the AP(AC) + 4 Function (Optional)

- 1 Turn the appliance on.
- 2 Press **6-in-1/AP(AC) + 4** button.
 - Press **6-in-1/AP(AC) + 4** button repeatedly to select each step.

NOTE

- 1 step (AI Plus Convertible Mode / AI Convertible Mode) : The air conditioner analyzes the surrounding environment and usage patterns to reach the desired temperature quickly. The airflow direction and fan speed are automatically adjusted to achieve the comfort settings.
 -  is displayed on the display screen.
- 2 step : The power Input is decreased by 20 % compared to rated power input.
 -  is displayed on the display screen.
- 3 step : The power Input is decreased by 40 % compared to rated power input.
 -  is displayed on the display screen.
- 4 step : The power Input is decreased by 60 % compared to rated power input.
 -  is displayed on the display screen.
-  (2 step),  (3 step) is displayed on some indoor units.
- This function is available with Cooling Mode.
- Capacity may decrease when AP(AC) + 4 is selected.
- Desired temperature is displayed about 5 seconds if you press **Fan Speed**,  or  button.
- Room temperature is displayed about 5 seconds if you press **Room Temp.** button.

AI Plus Convertible / AI Convertible Mode

This function controls the settings on the AI Plus Convertible / AI Convertible mode automatically.

- 1 Turn the appliance on.
- 2 Press the **6-in-1/AP(AC) + 4** button repeatedly until "AP(AC)" appears in the display.
 - The desired temperature, fan speed, and airflow direction change automatically based on the comfort settings.
 - If you select the AI Plus Convertible / AI Convertible mode when the product is in the Cooling mode, the air conditioner analyzes the surrounding environment to reach the desired temperature quickly. The airflow direction and fan speed are automatically adjusted to achieve the comfort settings.

NOTE

- To change the desired temperature, press the **Temp.** button on the remote.
- The AI Plus Convertible / AI Convertible and Cooling modes can be used at the same time.
- Pressing the **Mode** or **6-in-1/VIRAAT** buttons while in the AI Plus Convertible / AI Convertible mode operates the selected function.
- Pressing the **Comfort Air** or **Swing** buttons while in the AI Plus Convertible / AI Convertible mode initiates the Cooling mode.
- The temperature is continually adjusted to suit the user and the environment of use, so the temperatures displayed on the indoor unit and on the remote may be different.

Resetting Learned Information

The information gathered from the existing environments can be reset to allow learning of new spaces and user-specific information.

Press the **ON/OFF** button on the product for more than 13 seconds, and release the button when the alarm rings 4 times.

- The previously entered living area information will be deleted.

Type1

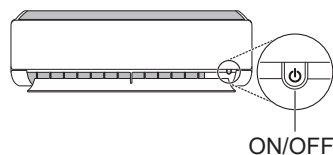

Type2

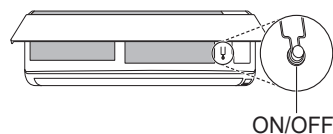

NOTE

- Be sure to release the button only after the alarm rings four times. If you release it before the alarm sounds four times, other features that are set may be disabled.

Using Special Functions

- 1 Turn the appliance on.
- 2 Press **Func.** button repeatedly to select the desired function.
- 3 Press **Set/Cancel** button to finish.

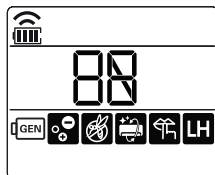

Display Screen	Description
	The Ion generator uses millions of ions to help improve indoor air quality.
	To remove moisture generated inside the indoor unit.

NOTE

- Some functions may not be supported, depending on the model.
- Some functions may operate differently from the remote control display.

Canceling Special Functions

- 1 Press **Func.** button repeatedly to select the desired function.
- 2 Press **Set/Cancel** button to cancel the function.

Using the Air Purification Function

These functions supply clean and fresh air by ion particles and the filter.

Function	Display	Description
Ionizer		Ion particles from Ionizer reduce the surface bacteria and other harmful substances.

NOTE

- You can use this function without turning the air conditioner on.
- Both the plasma lamp and the cooling lamp light up while Smoke Away/Plasma is in operation on some models.
- Do not touch ionizer during operation.
- This function may operate differently from the remote control display.

Using the Auto Clean Function

In the Cooling and Dehumidification Mode, moisture is generated inside the indoor unit. This function removes such moisture.

- is displayed on the display screen.

NOTE

- Some functions cannot be used while the Auto Clean function is in operation.
- If you turn off the unit, the fan continues to run for 30 minutes and cleans the inside of the indoor unit.
- is displayed on some indoor units, depending on the model.

LG ThinQ Application

This feature is only available on models with the  or **ThinQ** logo.

The **LG ThinQ** application allows you to communicate with the appliance using a smartphone.

LG ThinQ Application Features

Communicate with the appliance from a smartphone using the convenient smart features.

Smart Diagnosis

If you experience a problem while using the appliance, this smart diagnosis feature will help you diagnose the problem.

Settings

Allows you to set various options on the appliance and in the application.

NOTE

- If you change your wireless router, internet service provider, or password, delete the registered appliance from the **LG ThinQ** application and register it again.
- The application is subject to change for appliance improvement purposes without notice to users.
- Functions may vary by model.

Before Using LG ThinQ Application

- 1 Check the distance between the appliance and the wireless router (Wi-Fi network).
 - If the distance between the appliance and the wireless router is too far, the signal strength becomes weak. It may take a long time to register or installation may fail.

- 2 Turn off the **Mobile data** or **Cellular Data** on your smartphone.

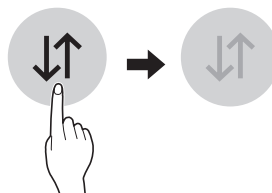

- 3 Connect your smartphone to the wireless router.

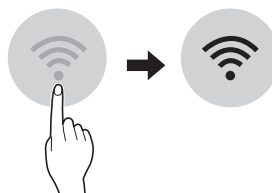

NOTE

- To verify the Wi-Fi connection, check that  icon on the control panel is lit.
- The appliance supports 2.4 GHz Wi-Fi networks only. To check your network frequency, contact your Internet service provider or refer to your wireless router manual.
- **LG ThinQ** is not responsible for any network connection problems or any faults, malfunctions, or errors caused by network connection.
- If the appliance is having trouble connecting to the Wi-Fi network, it may be too far from the router. Purchase a Wi-Fi repeater (range extender) to improve the Wi-Fi signal strength.
- The Wi-Fi connection may not connect or may be interrupted because of the home network environment.
- The network connection may not work properly depending on the Internet service provider.
- The surrounding wireless environment can make the wireless network service run slowly.

- The appliance cannot be registered due to problems with the wireless signal transmission. Unplug the appliance and wait about a minute before trying again.
- If the firewall on your wireless router is enabled, disable the firewall or add an exception to it.
- The wireless network name (SSID) should be a combination of English letters and numbers. (Do not use special characters.)
- Smartphone user interface (UI) may vary depending on the mobile operating system (OS) and the manufacturer.
- If the security protocol of the router is set to **WEP**, you may fail to set up the network. Please change it to other security protocols (**WPA2** is recommended) and register the product again.

Installing the LG ThinQ Application

Search for the **LG ThinQ** application from the Google Play Store or Apple App Store on a smartphone. Follow instructions to download and install the application.



Open Source Software Notice Information

To obtain the source code that is contained in this product, under GPL, LGPL, MPL, and other open source licenses that have the obligation to disclose source code, and to access all referred license terms, copyright notices and other relevant documents please visit <https://opensource.lge.com>.

LG Electronics will also provide open source code to you on CD-ROM for a charge covering the cost of performing such distribution (such as the cost of media, shipping, and handling) upon email request to opensource@lge.com.

This offer is valid to anyone in receipt of this information for a period of three years after our last shipment of this product.

Smart Diagnosis

This feature is only available on models with the  or  logo.

Use this feature to help you diagnose and solve problems with your appliance.

NOTE

- For reasons not attributable to LGE's negligence, the service may not operate due to external factors such as, but not limited to, Wi-Fi unavailability, Wi-Fi disconnection, local app store policy, or app unavailability.
- The feature may be subject to change without prior notice and may have a different form depending on where you are located.



Using LG ThinQ to Diagnose Issues

If you experience a problem with your Wi-Fi equipped appliance, it can transmit troubleshooting data to a smartphone using the **LG ThinQ** application.

- Launch the **LG ThinQ** application and select the **Smart Diagnosis** feature in the menu. Follow the instructions provided in the **LG ThinQ** application.

Using Audible Diagnosis to Diagnose Issues

Follow the instructions below to use the audible diagnosis method.

- Launch the **LG ThinQ** application and select the **Smart Diagnosis** feature in the menu. Follow the instructions for audible diagnosis provided in the **LG ThinQ** application.
- 1 Plug the power plug in the outlet properly.
 - 2 Place the mouthpiece of your smartphone close to the  or  logo.
 - 3 Press and hold the **Diagnosis(5 s)** button for 5 seconds or longer while holding the smartphone mouthpiece to the logo until the data transfer is complete.
 - Keep the smartphone in place until the data transfer has finished. Time remaining for data transfer is displayed.
 - 4 After the data transfer is complete, the diagnosis will be displayed in the application.

NOTE

- For best results, do not move the phone while the tones are being transmitted.
- Be sure to keep ambient noise to a minimum or the phone may not correctly receive the buzzer beeps from the indoor unit.

⚠ WARNING

- Before cleaning or performing maintenance, disconnect the power supply and wait until the fan stops.

If the air conditioner will not be used for an extended period of time, dry the air conditioner to maintain it in best condition. Clean the product regularly to maintain optimal performance and to prevent possible breakdown.

- Dry the air conditioner in Fan mode for 3 to 4 hours and disconnect the power. There may be internal damage if moisture is left in its components.
- Before using the air conditioner again, dry the inner components of the air conditioner in Fan mode for 3 to 4 hours. This will help to remove the odor generated from moisture.

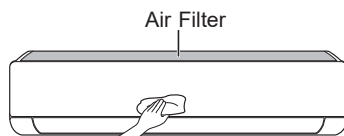

- The feature may be changed according to the type of model.

Type	Description	Interval
Air Filter	Clean with a vacuum or hand wash.	2 weeks
Triple Filter	Clean with a vacuum or brush.	Every 3 months
Micro Dust Filter	Clean with a vacuum or brush.	Once a month
Allergy Filter	Clean with a vacuum or brush.	Every 6 months
Ionizer (Optional)	Use dry cotton bud to remove any dust.	Every 6 months
Indoor Unit	Clean the indoor unit surface by using a soft, dry cloth.	Regularly
	Have a professional clean the condensate drain pan.	Once a year
	Have a professional clean the condensate drain pipe.	Every 4 months
	Replace the remote control batteries.	Once a year
Outdoor Unit	Have a professional clean the heat exchanger coils and the panel vents. (Consult with technician.)	Once a year
	Have a professional clean the fan.	Once a year
	Have a professional clean the condensate drain pan.	Once a year
	Have a professional verify that all the fan assembly is firmly tightened.	Once a year
	Clean the electric components with air.	Once a year

NOTE

- Never use water that is higher than 40 °C when you clean the filters. It may cause deformation or discoloration.
- Never use volatile substances when you clean the filters. They may damage the surface of the product.
- Do not wash the micro dust filter with water, because the filter can be damaged (Optional).
- Do not wash the triple filter with water, because the filter can be damaged (Optional).
- Do not wash the allergy filter with water, because the filter can be damaged (Optional).

Clean the Air Filter

Clean the air filters once every 2 weeks, or more, if necessary.

NOTE

- The air filter can be broken when it is bent.
- When the air filter is not assembled correctly, dust and other substances can enter into the indoor unit.

Type1

If you look at the indoor unit from above it, can assemble the top filter easily.

- 1 Turn off the power to the unit.
- 2 Hold the knobs of the air filter, lift it up slightly.

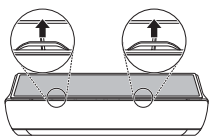

- 3 Remove it from the indoor unit.

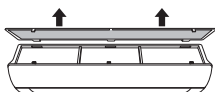

- 4 Clean the filter with a vacuum cleaner or with lukewarm water with neutral detergent.
- 5 Dry the filter in the shade.
- 6 Insert the hooks of the air filter into the front cover.

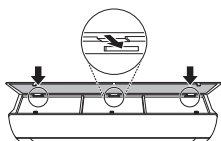

- 7 Push down hooks to assemble the air filter.

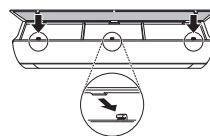

- 8 Check the side of the front cover for correct assembly of the air filter.

Type2

- 1 Turn off the power to the unit.
- 2 Open the front cover.
 - Lift up both sides of the cover slightly.
- 3 Hold the knobs of the air filters, pull them down slightly and remove them from the indoor unit.

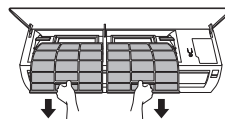

- 4 Clean the filters with a vacuum cleaner or with lukewarm water with neutral detergent.
- 5 Dry the filters in the shade.
- 6 Insert the hooks of the air filters into the front cover.

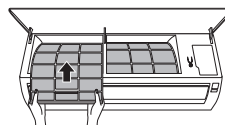

- 7 Check the side of the front cover for correct assembly of the air filters.

Clean the Micro Dust, Triple and Allergy Filter (Optional)

- 1 Turn off the power to the unit.
- 2 Remove the air filters from the indoor unit.
- 3 Remove the micro dust, triple and allergy filter from the indoor unit.

Type1

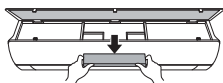

Type2

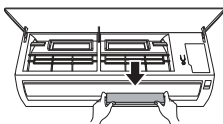

- 4 Clean the filter with a vacuum cleaner.

- 5 Insert the micro dust, triple and allergy filter.

Type1

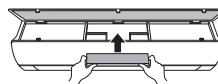

Type2

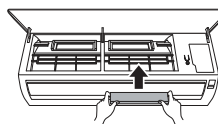

- 6 Assemble the air filters.
- 7 Check the side of the front cover for correct assembly of the air filters.

NOTE

- The feature and location of micro dust, triple and allergy filter may vary according to the type of model.

Self-diagnosis Function

This product has a built-in self-diagnosis function. If an error occurs, the lamp of the indoor unit will blink in 2 second intervals. If this occurs, contact your local dealer or service center.

Before Calling for Service

Please check the following before you contact the service center. If the problem persists, contact your local service center.

Symptoms	Possible Causes & Solution
The air conditioner does not work normally.	Burning smell and strange sounds are coming from the unit. <ul style="list-style-type: none"> • Turn off the air conditioner, switch OFF, or disconnect the power supply, and contact the service center.
	Water leaks from the indoor unit even when the humidity level is low. <ul style="list-style-type: none"> • Turn off the air conditioner, switch OFF, or disconnect the power supply, and contact the service center.
	The power cable is damaged or it is generating excessive heat. <ul style="list-style-type: none"> • Turn off the air conditioner, switch OFF, or disconnect the power supply, and contact the service center.
	A switch, a circuit breaker (safety, ground), or a fuse is not operated properly. <ul style="list-style-type: none"> • Turn off the air conditioner, switch OFF, or disconnect the power supply, and contact the service center.
	The unit generates an error code from its self-diagnosis. <ul style="list-style-type: none"> • Turn off the air conditioner, switch OFF, or disconnect the power supply, and contact the service center.
The air conditioner does not work.	The air conditioner is unplugged. <ul style="list-style-type: none"> • Check whether the power cord is plugged into the outlet or the power isolators are switched on.
	A fuse exploded, or the power supply is blocked. <ul style="list-style-type: none"> • Replace the fuse or check if the circuit breaker has tripped.
	A power failure has occurred. <ul style="list-style-type: none"> • Turn off the air conditioner when a power failure occurs. • When the power is restored, wait 3 minutes, and then turn on the air conditioner.
	The voltage is too high or too low. <ul style="list-style-type: none"> • Check if the circuit breaker has tripped.
	The air conditioner was turned off automatically at a preset time. <ul style="list-style-type: none"> • Turn the air conditioner on.
	The battery setting in the remote controller is incorrect. <ul style="list-style-type: none"> • Make sure that the batteries are inserted correctly in your remote controller. • If the batteries are placed correctly, but the air conditioner still does not operate, replace the batteries and try again.

Symptoms	Possible Causes & Solution
The air conditioner does not emit cool air.	Air is not circulating properly. <ul style="list-style-type: none"> • Make sure that there are no curtains, blinds, or pieces of furniture blocking the front of the air conditioner.
	The air filter is dirty. <ul style="list-style-type: none"> • Clean the air filter once every 2 weeks. • See “Clean the Air Filter” for more information.
	The room temperature is too high. <ul style="list-style-type: none"> • In summer, cooling the indoor air fully may take some time. In this case, select the VIRAAT to cool the indoor air quickly.
	Cold air is escaping from the room. <ul style="list-style-type: none"> • Make sure that no cold air is escaping through the ventilation points in the room.
	The desired temperature is higher than the current temperature. <ul style="list-style-type: none"> • Set the desired temperature to a level lower than the current temperature.
	There is a heating source nearby. <ul style="list-style-type: none"> • Avoid using heat generators like electric ovens or gas burners while the air conditioner is in operation.
	Fan Mode is selected. <ul style="list-style-type: none"> • During Fan Mode, air blows from the air conditioner without cooling or heating the indoor air. • Switch the operation mode to cooling operation.
	Outside temperature is too high. <ul style="list-style-type: none"> • The cooling effect may not be sufficient.
The fan speed cannot be adjusted.	The VIRAAT is selected. <ul style="list-style-type: none"> • In some operation modes, you cannot adjust the fan speed. Select an operation mode in which you can adjust the fan speed.
The temperature cannot be adjusted.	The Fan Mode or VIRAAT is selected. <ul style="list-style-type: none"> • In some operation modes, you cannot adjust the temperature. Select an operation mode in which you can adjust the temperature.
The air conditioner stops during operation.	The air conditioner is suddenly turned off. <ul style="list-style-type: none"> • The Timer Function may have timed out, which turns the unit off. Check the timer settings.
	A power failure has occurred during operation. <ul style="list-style-type: none"> • Wait for the power to come back. If you have the Auto Restart function enabled, your unit will resume its last operation several minutes after power is restored.

Symptoms	Possible Causes & Solution
The indoor unit is still operating even when the unit has been turned off.	<p>The Auto Clean function is being operated.</p> <ul style="list-style-type: none"> Allow the Auto Clean function to continue since it removes any remaining moisture inside the indoor unit. If you do not want this feature, you can turn the unit off.
The air outlet on the indoor unit is discharging mist.	<p>The cooled air from the air conditioner makes mist.</p> <ul style="list-style-type: none"> When the room temperature decreases, this phenomenon will disappear.
Water leaks from the outdoor unit.	<p>In the heating operations, condensed water drops from the heat exchanger.</p> <ul style="list-style-type: none"> This symptom requires installing a drain hose under the base pan. Contact the installer.
There is noise or vibration.	<p>A clicking sound can be heard when the unit starts or stops due to movement of the reversing valve. Creaking sound: The plastic parts of the indoor unit creak when they shrink or expand due to sudden temperature changes. Flowing or Blowing sound: This is the flow of refrigerant through the air conditioner.</p> <ul style="list-style-type: none"> These are normal symptoms. The noise will stop.
The indoor unit gives off an odor.	<p>Odors (such as cigarette smoke) may be absorbed into the indoor unit and discharged with airflow.</p> <ul style="list-style-type: none"> If the smell does not disappear, you need to wash the filter. If this does not work, contact the service center to clean your heat exchanger.
The air conditioner does not emit warm air.	<p>When Heating Mode starts, the vane is almost closed, and no air comes out, even though the outdoor unit is operating.</p> <ul style="list-style-type: none"> This symptom is normal. Please wait until the unit has generated enough warm air to blow through the indoor unit.
	<p>The outdoor unit is in Defrosting Mode.</p> <ul style="list-style-type: none"> In Heating Mode, ice/frost is built up on the coils when the outside temperature falls. This function removes a layer of frost on the coil, and it should finish in approximately 15 minutes.
	<p>Outside temperature is too low.</p> <ul style="list-style-type: none"> The heating effect may not be sufficient.

Symptoms	Possible Causes & Solution
Your home appliance and smartphone is not connected to the Wi-Fi network.	The password for the Wi-Fi that you are trying to connect to is incorrect. <ul style="list-style-type: none"> Find the Wi-Fi network connected to your smartphone and remove it, then register your appliance on LG ThinQ.
	Mobile data for your smartphone is turned on. <ul style="list-style-type: none"> Turn off the Mobile data of your smartphone and register the appliance using the Wi-Fi network.
	The wireless network name (SSID) is set incorrectly. <ul style="list-style-type: none"> The wireless network name (SSID) should be a combination of English letters and numbers. (Do not use special characters.)
	The router frequency is not 2.4 GHz. <ul style="list-style-type: none"> Only a 2.4 GHz router frequency is supported. Set the wireless router to 2.4 GHz and connect the appliance to the wireless router. To check the router frequency, check with your Internet service provider or the router manufacturer.
	The distance between the appliance and the router is too far. <ul style="list-style-type: none"> If the distance between the appliance and the router is too far, the signal may be weak and the connection may not be configured correctly. Move the location of the router so that it is closer to the appliance.

NOTE

- Some functions may not be supported, depending on the model.

**NOTE**

- Scan QR Code for Installation Manual
- Repair & replacement will be carried out through the Authorized Service Centers of LG Electronics India Pvt Ltd.
- It is strictly advised not to alter the installation position or shifting the Air-Conditioner from one premises to another on its own. It is recommended that any such alternation should be carried out by the LG Electronics Customer Care or its Authorized Service Franchisee/Sales & Service Dealer only.
- Please refer cautions and warning's as given under the Installation Manual after scanning the above QR code.
- All installations or change in position of Installation should be done by LG Authorized person so as to remain under warranty.

Memo



QR code for
Installation manual



LG DIY Service
Do It Yourself

LG 24 x 7 CUSTOMER CARE

1800-315-9999 **5757554**
CALL (Toll Free) SMS (Send SMS)

www.lg.com/in/support

LG WhatsApp No.
9711709999

LG Service India Mobile App
Available at Google Play

www.facebook.com/lgindiapage/

www.twitter.com/LGIndia

To know more about LG,
visit www.lg.com/in
For Corporate/Institutional enquiries,
please write to corp.enquiries@lge.com